

# TPS.

**TAYLOR PROJECT SERVICES LLP**  
BUILDING SERVICES CONSULTANTS



## THE BEDFORD ESTATES



**74-77 GREAT RUSSELL STREET – 29A&B MONTAGUE ST, LONDON, WC1B 3DA**  
DRAWING ISSUE (PLANNING)

DATE OF ISSUE (26.01.23)

THIS DRAWING MUST NOT BE REPRODUCED WITHOUT PRIOR CONSENT.  
DO NOT SCALE FROM THIS DRAWING  
THIS DRAWING IS COPYRIGHT ©

**GENERAL NOTES**

1. DOOR CONTROLS SHOWN FOR INCORPORATION OF CONDUITS ONLY

**LEGEND**

- TWIN SWITCHED SOCKET OUTLET
- SWITCHED FUSED CONNECTION UNIT WITH NEON INDICATOR
- RJ45 4G IT OUTLET
- HAND DRYER
- 4 GANG UNDERFLOOR POWER MODULE
- 4 GANG RJ45 IT MODULE
- FLUSH FLOOR 3 COMPARTMENT TRUNKING OUTLET BOX C/W 2x13A SSO & RJ45 4G OUTLET
- CONDUIT BOX AT 1000 AFPL FOR BADGE READER
- CONDUIT TO DOOR FRAME FOR DOOR CONTACT/MAGNET
- CONDUIT BOX AT 1000 AFPL FOR EXIT BUTTON
- 32mm HOLE IN BEAM
- 2 No. 0.5mm WIRES FOR FUTURE CABLE (IT/POWER) INSTALLATION

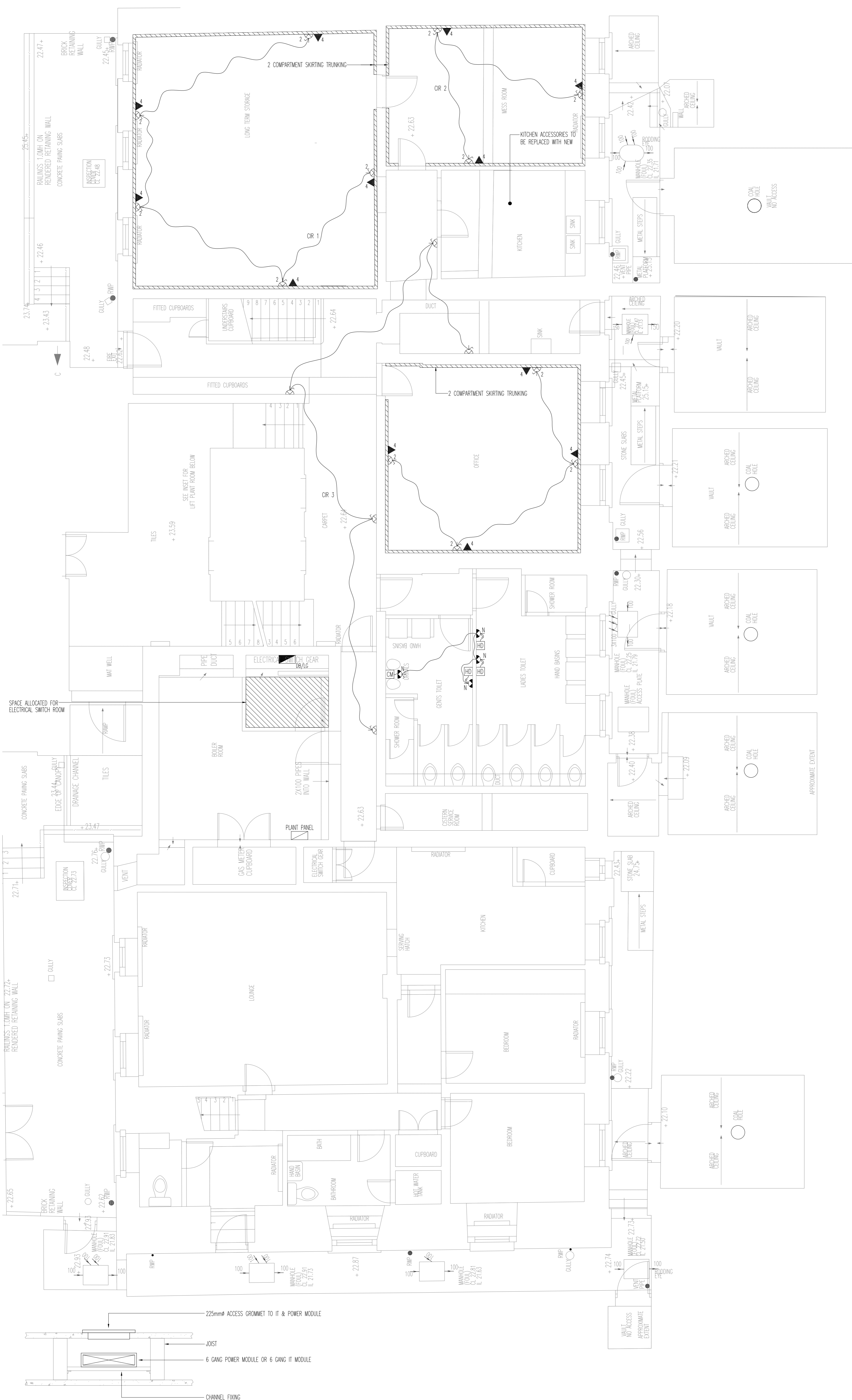

**EXISTING PLANNING**

0	JAN.23	PLANNING ISSUE
---	--------	----------------

REV	DATE	DESCRIPTION
-----	------	-------------

**TPS.**  
Taylor Project Services LLP  
No.1 Cornhill  
London EC3V 3ND  
Tel 020 7743 6602  
www.taylorprojectservices.com

CLIENT  
  
**THE BEDFORD ESTATES**

PROJECT  
74-77 GREAT RUSSELL STREET  
LONDON  
WC1B 3DA

DRAWING TITLE  
**LOWER GROUND  
LOW LEVEL ELECTRICAL  
SERVICES LAYOUT  
EXISTING**

SCALE	1:50@A1	DATE	09.11.22
DRAWN	L.R.	CHECKED	G.N.T.

DRAWING STATUS  
**PLANNING**

DATE PLOTTED	20/1/23	DRAWING NO.	TPS/2247/LG/E/LL	REVISION	0
--------------	---------	-------------	------------------	----------	---

POWER/IT MODULE DETAIL  
(SCALE 1:10)

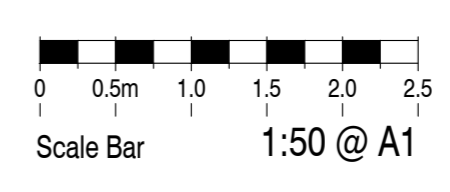













THIS DRAWING MUST NOT BE REPRODUCED WITHOUT PRIOR CONSENT.  
DO NOT SCALE FROM THIS DRAWING  
THIS DRAWING IS COPYRIGHT ©

**GENERAL NOTES**

1. DOOR CONTROLS SHOWN FOR INCORPORATION OF CONDUITS ONLY

**LEGEND**

-  TWIN SWITCHED SOCKET OUTLET
-  SWITCHED FUSED CONNECTION UNIT WITH NEON INDICATOR
-  RJ45 4G IT OUTLET
-  HAND DRYER
-  4 GANG UNDERFLOOR POWER MODULE
-  4 GANG RJ45 IT MODULE
-  FLUSH FLOOR 3 COMPARTMENT TRUNKING OUTLET BOX C/W 2x13A SSO & RJ45 4G OUTLET
-  CONDUIT BOX AT 1000 AFPL FOR BADGE READER
-  CONDUIT TO DOOR FRAME FOR DOOR CONTACT/MAGNET
-  CONDUIT BOX AT 1000 AFPL FOR EXIT BUTTON
-  \* 32mm HOLE IN BEAM
-  2 No. DRAW WIRES FOR FUTURE CABLE (IT/POWER) INSTALLATION

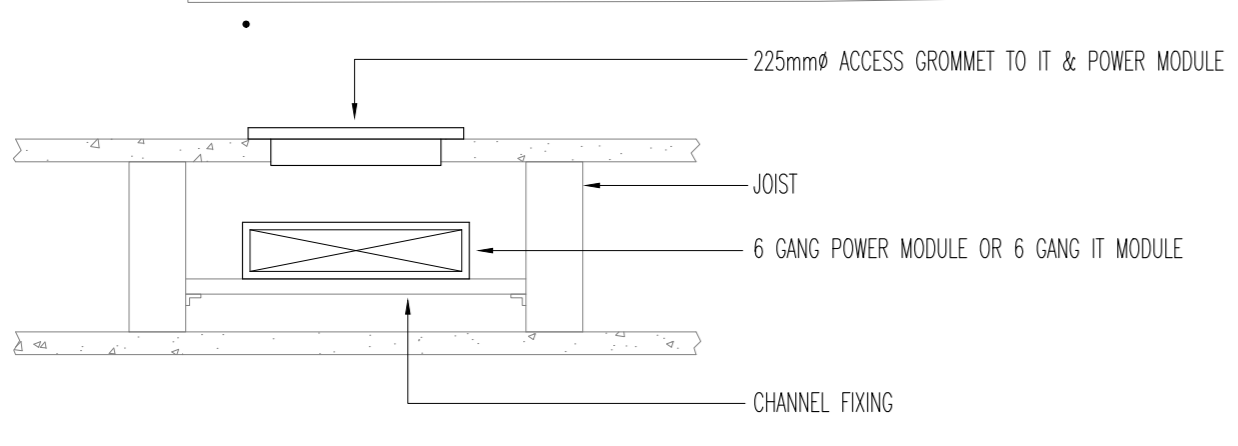
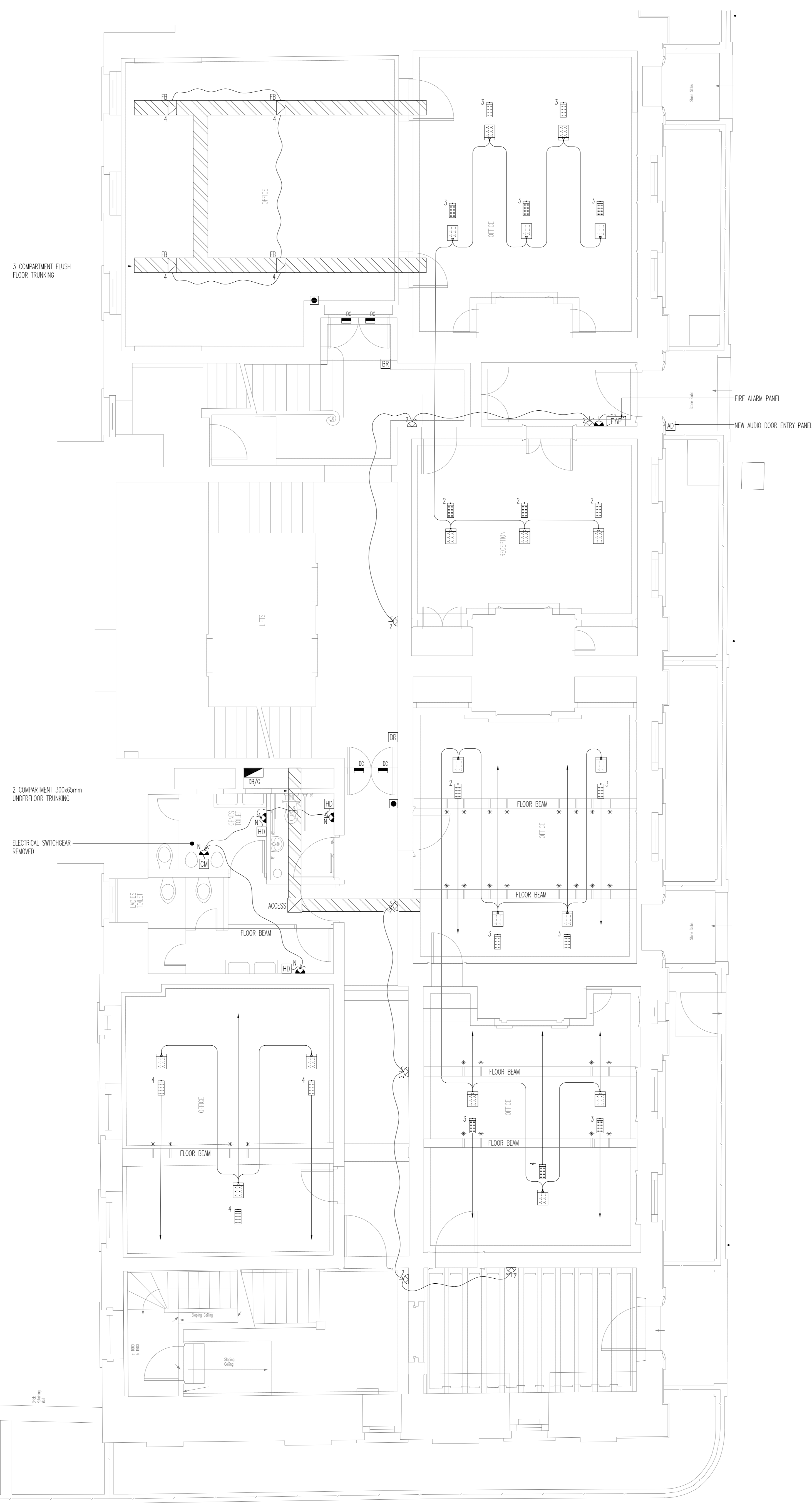

POWER/IT MODULE DETAIL  
(SCALE 1:10)

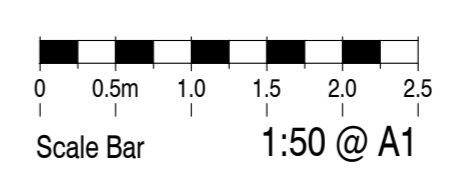

**EXISTING PLANNING**

0	JAN.23	PLANNING ISSUE
---	--------	----------------

REV	DATE	DESCRIPTION
-----	------	-------------

**TPS.**

Taylor Project Services LLP  
No.1 Cornhill  
London EC3V 3ND  
Tel 020 7743 6602  
www.taylorprojectservices.com

CLIENT



**THE BEDFORD ESTATES**

PROJECT  
74-77 GREAT RUSSELL STREET  
LONDON  
WC1B 3DA

DRAWING TITLE  
**GROUND FLOOR  
LOW LEVEL ELECTRICAL  
SERVICES LAYOUT  
EXISTING**

SCALE	1:50@A1	DATE	09.11.22
DRAWN	L.R.	CHECKED	G.N.T.

DRAWING STATUS  
**PLANNING**

DATE PLOTTED	20/1/23	REVISION	0
DRAWING NO.	TPS/2247/G/E/LL		

THIS DRAWING MUST NOT BE REPRODUCED WITHOUT PRIOR CONSENT.  
DO NOT SCALE FROM THIS DRAWING  
THIS DRAWING IS COPYRIGHT ©

**GENERAL NOTES**

- DOOR CONTROLS SHOWN FOR INCORPORATION OF CONDUITS ONLY

**LEGEND**

- TWIN SWITCHED SOCKET OUTLET
- SWITCHED FUSED CONNECTION UNIT WITH NEON INDICATOR
- RJ45 4G IT OUTLET
- HAND DRYER
- 4 GANG UNDERFLOOR POWER MODULE
- 4 GANG RJ45 IT MODULE
- FLUSH FLOOR 3 COMPARTMENT TRUNKING OUTLET BOX C/W 2x13A SSO & RJ45 4G OUTLET
- CONDUIT BOX AT 1000 AFFL FOR BADGE READER
- CONDUIT TO DOOR FRAME FOR DOOR CONTACT/MAGNET
- CONDUIT BOX AT 1000 AFFL FOR EXIT BUTTON
- 32mm HOLE IN BEAM
- 2 No. DRAW WIRES FOR FUTURE CABLE (IT/POWER) INSTALLATION

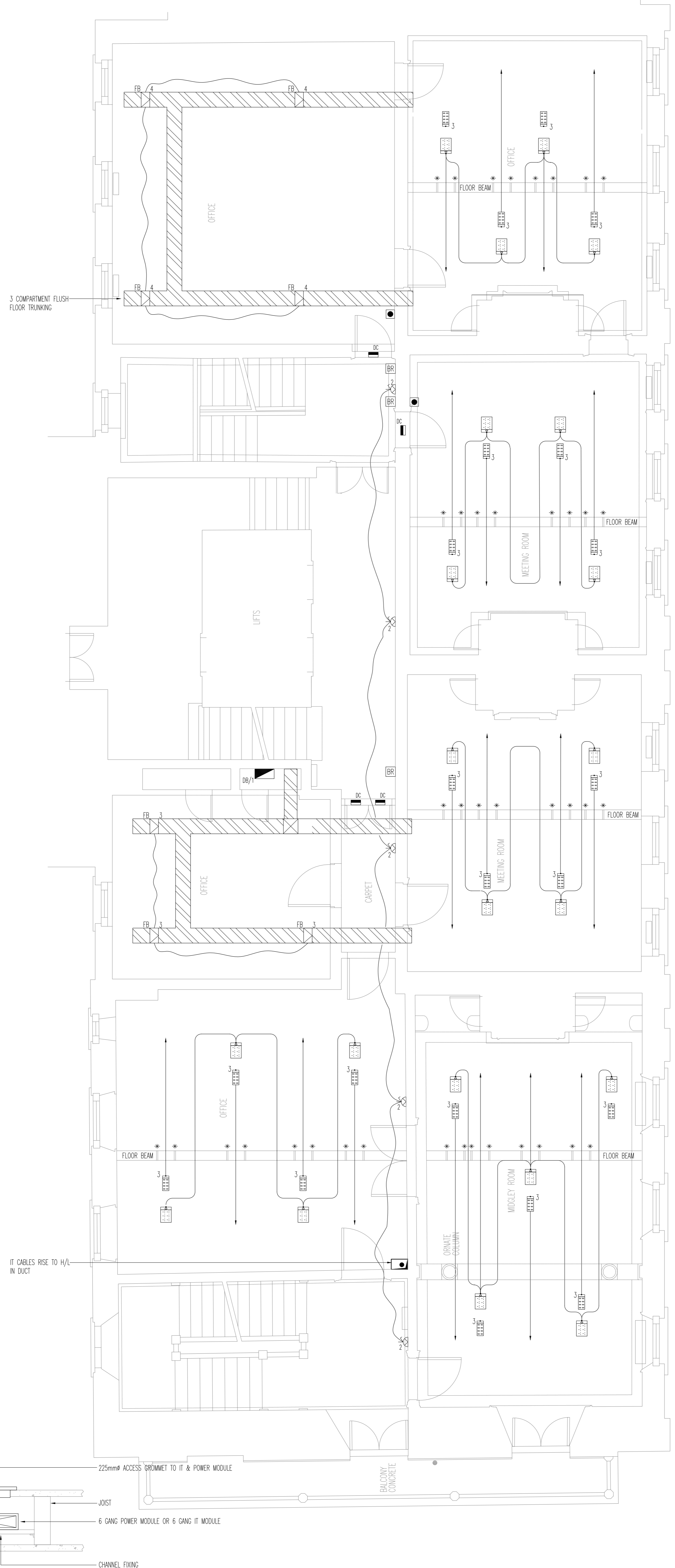

**EXISTING PLANNING**

0	JAN.23	PLANNING ISSUE
---	--------	----------------

REV	DATE	DESCRIPTION
-----	------	-------------

**TPS.**

Taylor Project Services LLP  
No.1 Cornhill  
London EC3V 3ND  
Tel 020 7743 6602  
www.taylorprojectservices.com

CLIENT

**THE BEDFORD ESTATES**

PROJECT  
74-77 GREAT RUSSELL STREET  
LONDON  
WC1B 3DA

DRAWING TITLE  
**FIRST FLOOR  
LOW LEVEL ELECTRICAL  
SERVICES LAYOUT  
EXISTING**

SCALE	1:50@A1	DATE	09.11.22
DRAWN	L.R.	CHECKED	G.N.T.

DRAWING STATUS  
**PLANNING**

DATE PLOTTED	20/1/23	REVISION	0
--------------	---------	----------	---

POWER/IT MODULE DETAIL  
(SCALE 1:10)

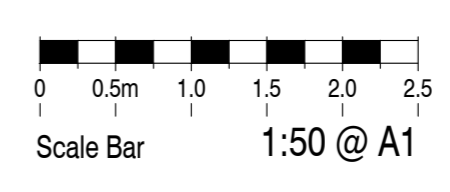













THIS DRAWING MUST NOT BE REPRODUCED WITHOUT PRIOR CONSENT.  
DO NOT SCALE FROM THIS DRAWING  
THIS DRAWING IS COPYRIGHT ©

**GENERAL NOTES**

1. DOOR CONTROLS SHOWN FOR INCORPORATION OF CONDUITS ONLY

**LEGEND**

-  TWIN SWITCHED SOCKET OUTLET
-  SWITCHED FUSED CONNECTION UNIT WITH NEON INDICATOR
-  RJ45 4G IT OUTLET
-  HAND DRYER
-  4 GANG UNDERFLOOR POWER MODULE
-  4 GANG RJ45 IT MODULE
-  FLUSH FLOOR 3 COMPARTMENT TRUNKING OUTLET BOX C/W 2x13A SSO & RJ45 4G OUTLET
-  CONDUIT BOX AT 1000 AFPL FOR BADGE READER
-  CONDUIT TO DOOR FRAME FOR DOOR CONTACT/MAGNET
-  CONDUIT BOX AT 1000 AFPL FOR EXIT BUTTON
-  32Ø HOLE IN BEAM
-  2 No. DRAW WIRES FOR FUTURE CABLE (IT/POWER) INSTALLATION

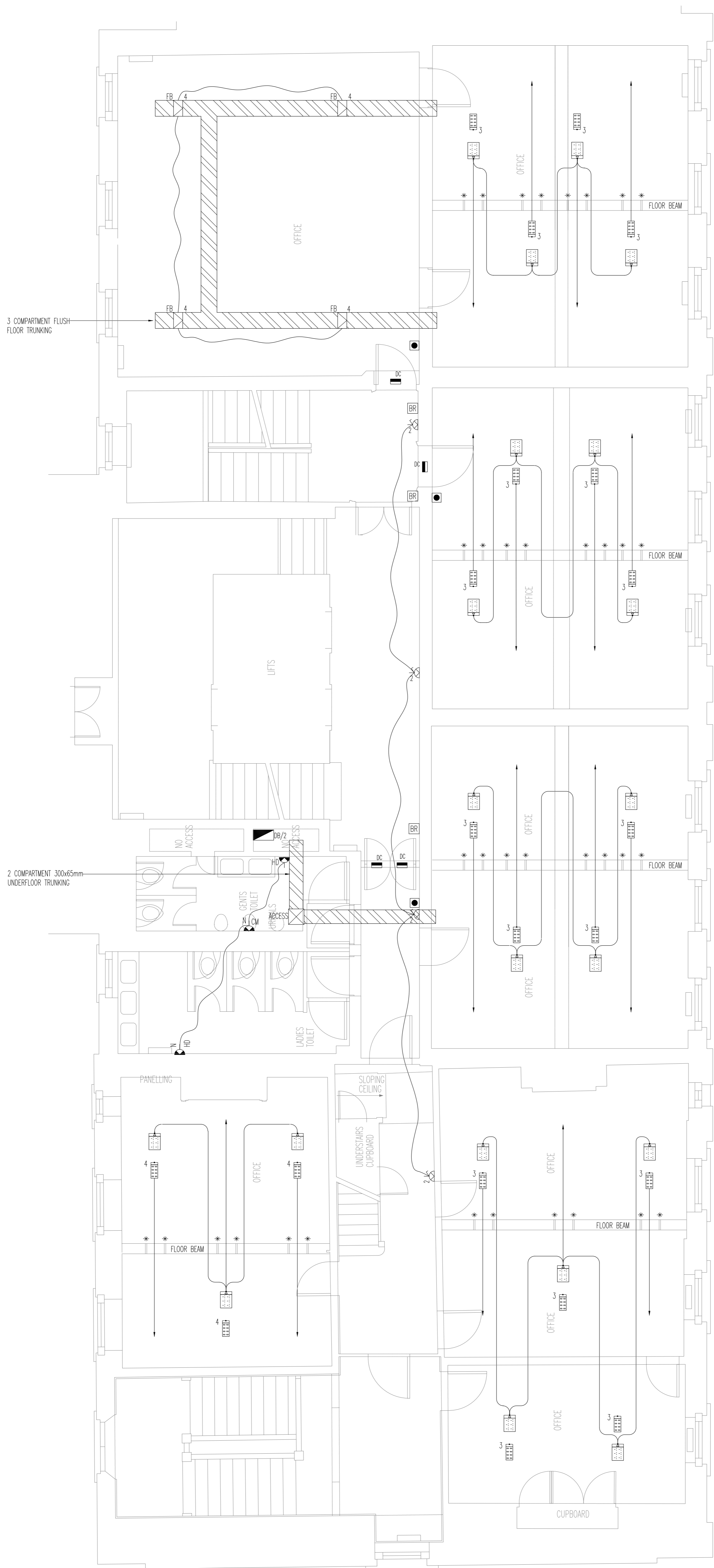

3 COMPARTMENT FLUSH FLOOR TRUNKING

2 COMPARTMENT 300x65mm UNDERFLOOR TRUNKING

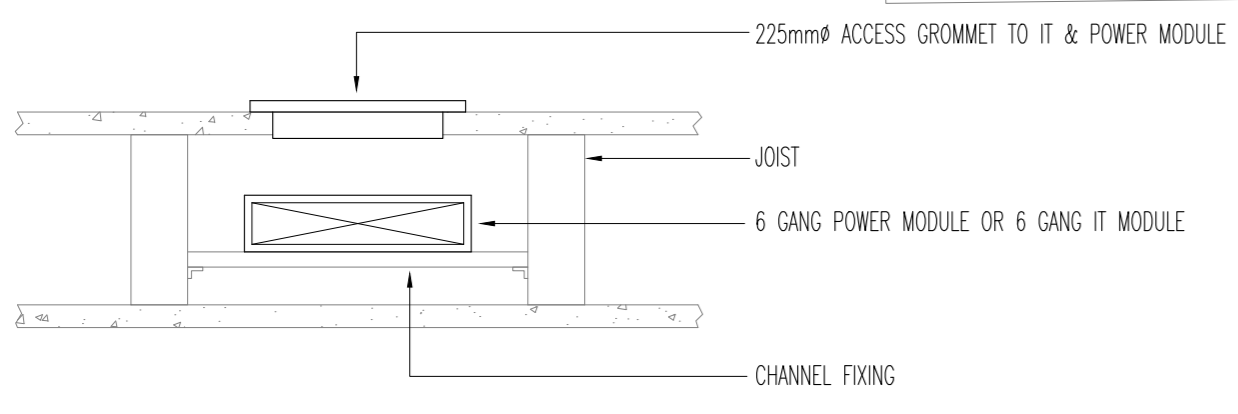

POWER/IT MODULE DETAIL (SCALE 1:10)

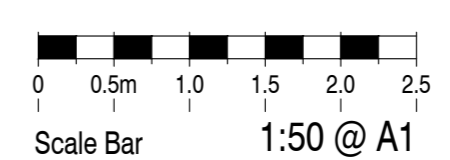

**EXISTING PLANNING**

0	JAN.23	PLANNING ISSUE
---	--------	----------------

REV	DATE	DESCRIPTION
-----	------	-------------

**TPS.**

Taylor Project Services LLP  
No.1 Cornhill  
London EC3V 3ND  
Tel 020 7743 6602  
www.taylorprojectservices.com

CLIENT



**THE BEDFORD ESTATES**

PROJECT  
74-77 GREAT RUSSELL STREET  
LONDON  
WC1B 3DA

DRAWING TITLE  
**SECOND FLOOR  
LOW LEVEL ELECTRICAL  
SERVICES LAYOUT  
EXISTING**

SCALE	1:50@A1	DATE	09.11.22
DRAWN	L.R.	CHECKED	G.N.T.

DRAWING STATUS  
**PLANNING**

DATE PLOTTED	20/1/23
DRAWING NO.	TPS/2247/2/E/LL
REVISION	0

THIS DRAWING MUST NOT BE REPRODUCED WITHOUT PRIOR CONSENT.  
DO NOT SCALE FROM THIS DRAWING  
THIS DRAWING IS COPYRIGHT ©

**GENERAL NOTES**

- DOOR CONTROLS SHOWN FOR INCORPORATION OF CONDUITS ONLY

**LEGEND**

- TWIN SWITCHED SOCKET OUTLET
- SWITCHED FUSED CONNECTION UNIT WITH NEON INDICATOR
- RJ45 4G IT OUTLET
- HAND DRYER
- 4 GANG UNDERFLOOR POWER MODULE
- 4 GANG RJ45 IT MODULE
- FLUSH FLOOR 3 COMPARTMENT TRUNKING OUTLET BOX C/W 2x13A SSO & RJ45 4G OUTLET
- CONDUIT BOX AT 1000 AFPL FOR BADGE READER
- CONDUIT TO DOOR FRAME FOR DOOR CONTACT/MAGNET
- CONDUIT BOX AT 1000 AFPL FOR EXIT BUTTON
- 32mm HOLE IN BEAM
- 2 No. DRAW WIRES FOR FUTURE CABLE (IT/POWER) INSTALLATION

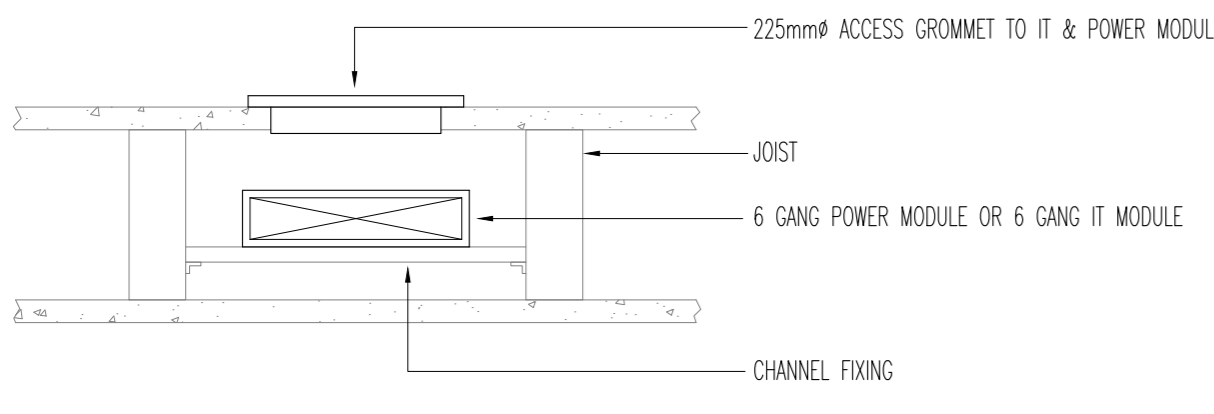
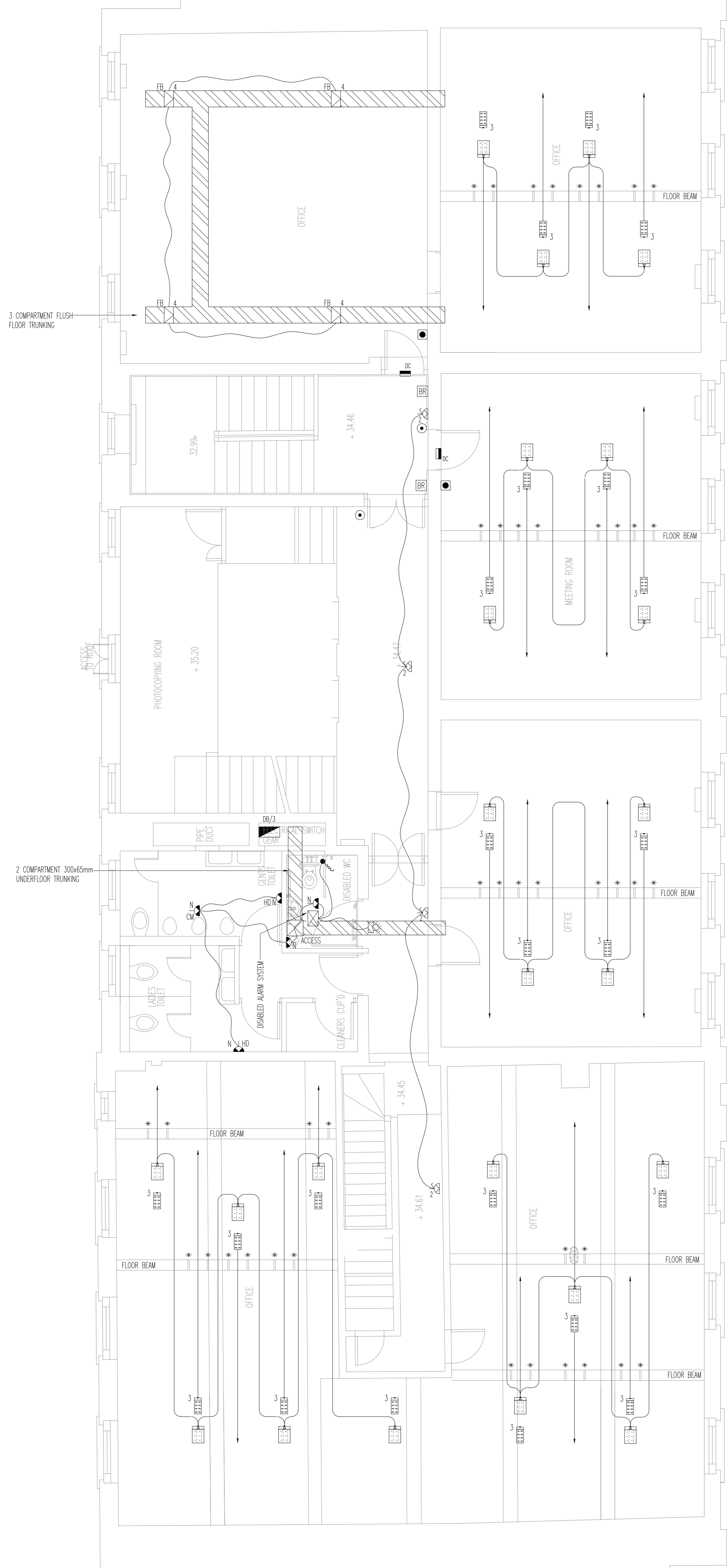

POWER/IT MODULE DETAIL  
(SCALE 1:10)

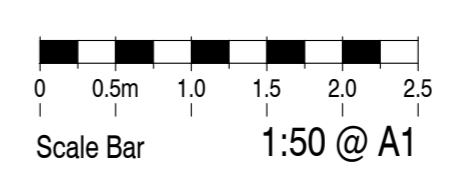

**EXISTING PLANNING**

0	JAN.23	PLANNING ISSUE
---	--------	----------------

REV	DATE	DESCRIPTION
-----	------	-------------

**TPS.**

Taylor Project Services LLP  
No.1 Cornhill  
London EC3V 3ND  
Tel 020 7743 6602  
www.taylorprojectservices.com

CLIENT



**THE BEDFORD ESTATES**

PROJECT  
74-77 GREAT RUSSELL STREET  
LONDON  
WC1B 3DA

DRAWING TITLE  
**THIRD FLOOR  
LOW LEVEL ELECTRICAL  
SERVICES LAYOUT  
EXISTING**

SCALE	1:50@A1	DATE	09.11.22
DRAWN	L.R.	CHECKED	G.N.T.

DRAWING STATUS  
**PLANNING**

DATE PLOTTED	20/1/23	REVISION	0
DRAWING NO.	TPS/2247/3/E/LL		

THIS DRAWING MUST NOT BE REPRODUCED WITHOUT PRIOR CONSENT.  
DO NOT SCALE FROM THIS DRAWING  
THIS DRAWING IS COPYRIGHT ©

**GENERAL NOTES**

- DOOR CONTROLS SHOWN FOR INCORPORATION OF CONDUITS ONLY

**LEGEND**

- TWIN SWITCHED SOCKET OUTLET
- SWITCHED FUSED CONNECTION UNIT WITH NEON INDICATOR
- RJ45 4G IT OUTLET
- HAND DRYER
- 4 GANG UNDERFLOOR POWER MODULE
- 4 GANG RJ45 IT MODULE
- FLUSH FLOOR 3 COMPARTMENT TRUNKING OUTLET BOX C/W 2x13A SSO & RJ45 4G OUTLET
- CONDUIT BOX AT 1000 AFPL FOR BADGE READER
- CONDUIT TO DOOR FRAME FOR DOOR CONTACT/MAGNET
- CONDUIT BOX AT 1000 AFPL FOR EXIT BUTTON
- 32mm HOLE IN BEAM
- 2 No. DRAW WIRES FOR FUTURE CABLE (IT/POWER) INSTALLATION

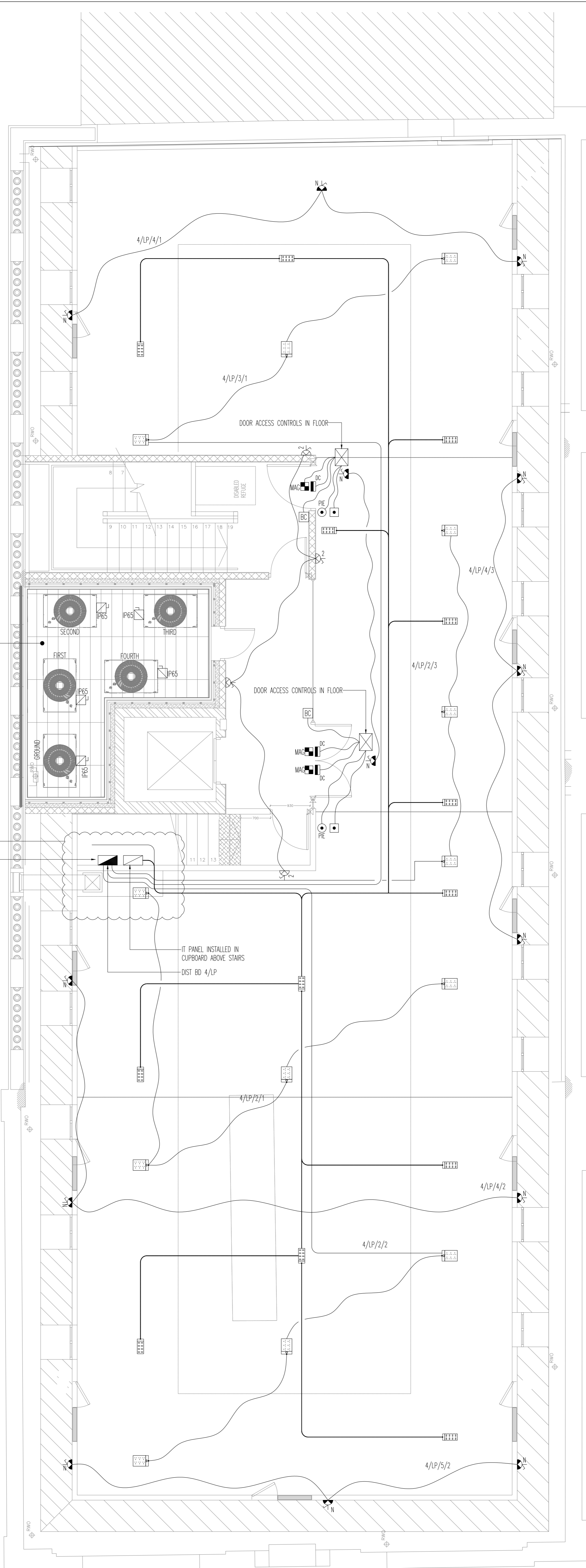

VRY CONDENSERS WITH 32A TPAN ISOLATORS (IP65)  
EACH UNIT FED BY A 10mm<sup>2</sup> XLPE/SMA/LSF CABLE  
FROM THE RESPECTIVE DISTRIBUTION BOARD

DETAILS OF CUPBOARD & RISER CONNECTIONS  
TO BE CO-ORDINATED ON SITE  
DISTRIBUTION BOARD WITH METER FACILITY  
ON INCOMING SUPPLY. FED FROM TAP-OFF  
ON THIRD FLOOR

IT PANEL INSTALLED IN  
CUPBOARD ABOVE STAIRS  
DIST BD 4/LP

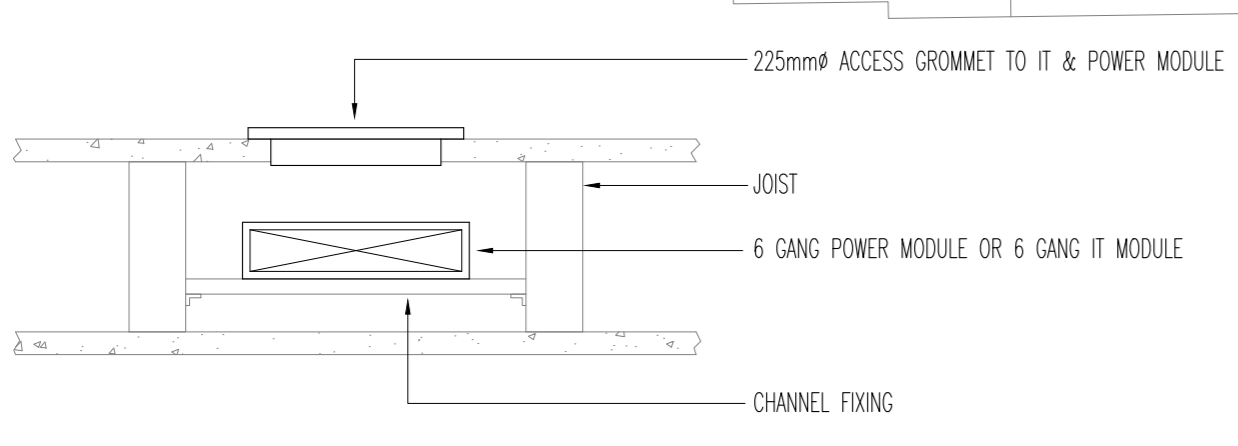

**POWER/IT MODULE DETAIL**  
(SCALE 1:10)

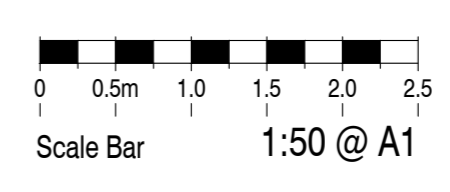

**EXISTING  
PLANNING**

0	JAN.23	PLANNING ISSUE
---	--------	----------------

REV	DATE	DESCRIPTION
-----	------	-------------

**TPS.**

Taylor Project Services LLP  
No.1 Cornhill  
London EC3V 3ND  
Tel 020 7743 6602  
www.taylorprojectservices.com

CLIENT



**THE BEDFORD ESTATES**

PROJECT  
74-77 GREAT RUSSELL STREET  
LONDON  
WC1B 3DA

DRAWING TITLE  
**FOURTH FLOOR  
LOW LEVEL ELECTRICAL  
SERVICES LAYOUT  
EXISTING**

SCALE	1:50@A1	DATE	09.11.22
DRAWN	L.R.	CHECKED	G.N.T.

DRAWING STATUS  
**PLANNING**

DATE PLOTTED	20/1/23	REVISION	0
DRAWING NO.	TPS/2247/4/E/LL		