

- C1317 -

REV A
23/09/2021

Seen From Outside

ORIGINAL
SASH

1/20

Front Elevation - 1st Floor - Office
Weight Loaded Timber Sash Window

SW01
SW02
SW03
SW04

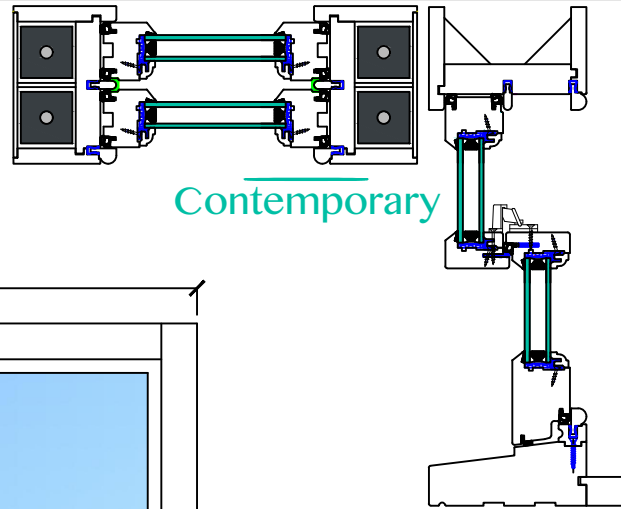

Contemporary

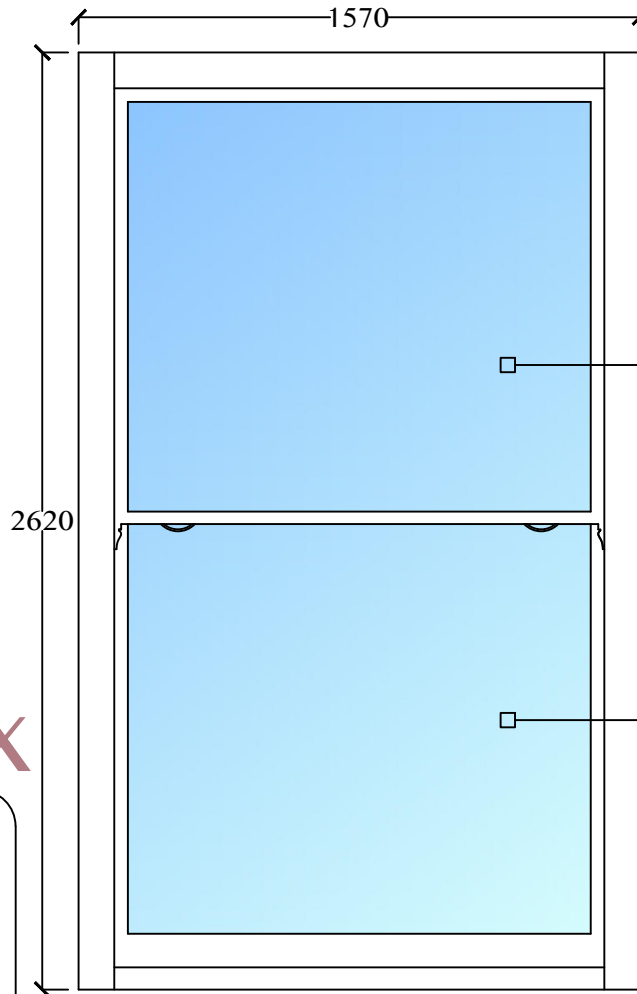

INSIDE LOW E
4 argon 18
15.5 Ar
4 39.948
OUTSIDE Float

TOUGHENED
INSIDE LOW E
4 argon 18
15.5 Ar
4 39.948
OUTSIDE Float

Project address:
Doughty Street
WC1N 2PH

1

Client:
Vimal Shah

Paint Details:

INSIDE: RAL 9016 WHITE

OUTSIDE: RAL 9016 WHITE

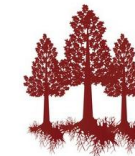

REDWOOD

Weights

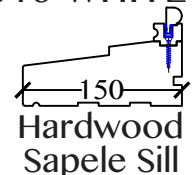

Horns:



External



Internal

Round Profile
Internal
Glazing



Ironmongery Finish: SATIN CHROME

2X



Sash Stop

2X



Heritage Lock

2X



Outside D
Handles

4X



Pulleys

2X



Sash Lifts

Notes:

Fitting:

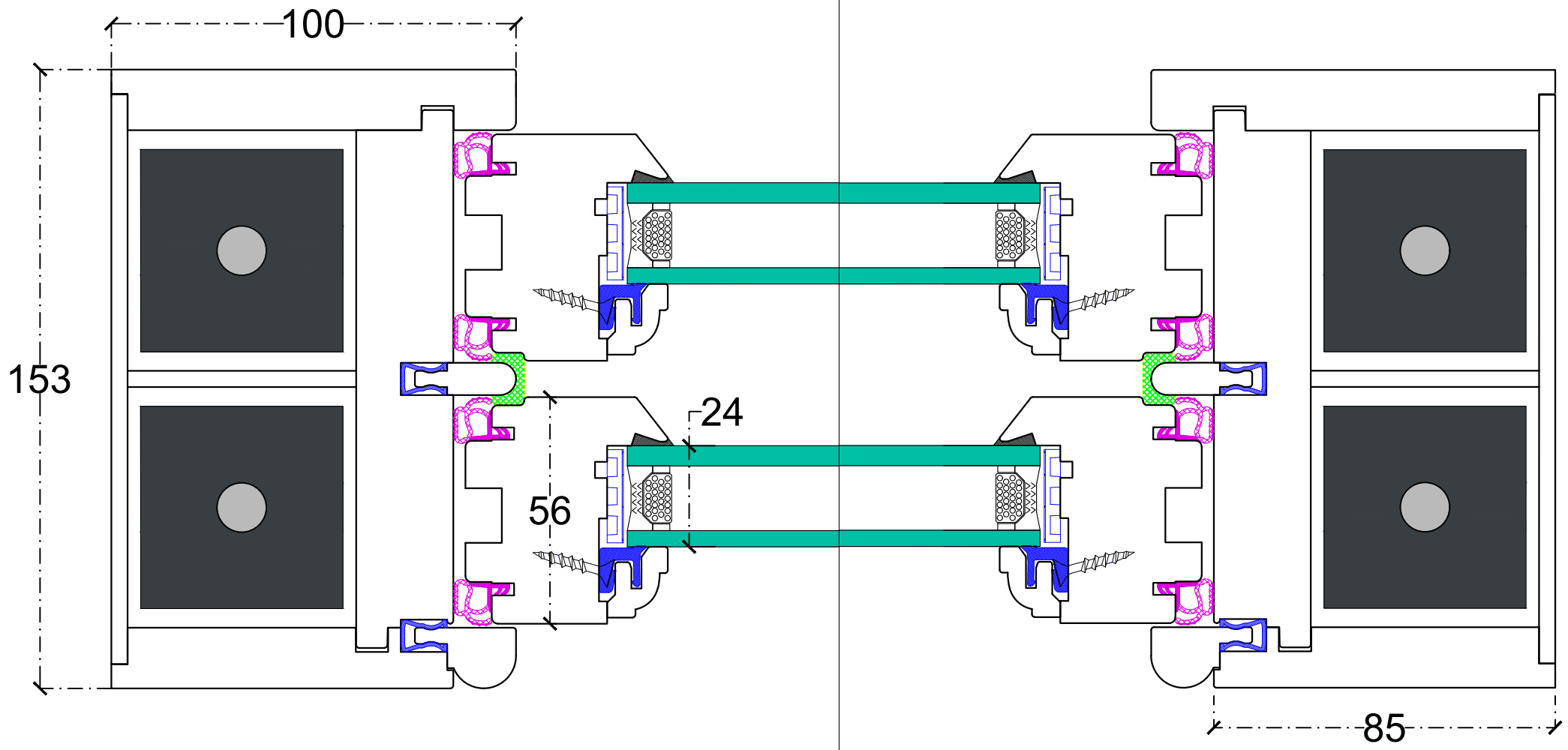

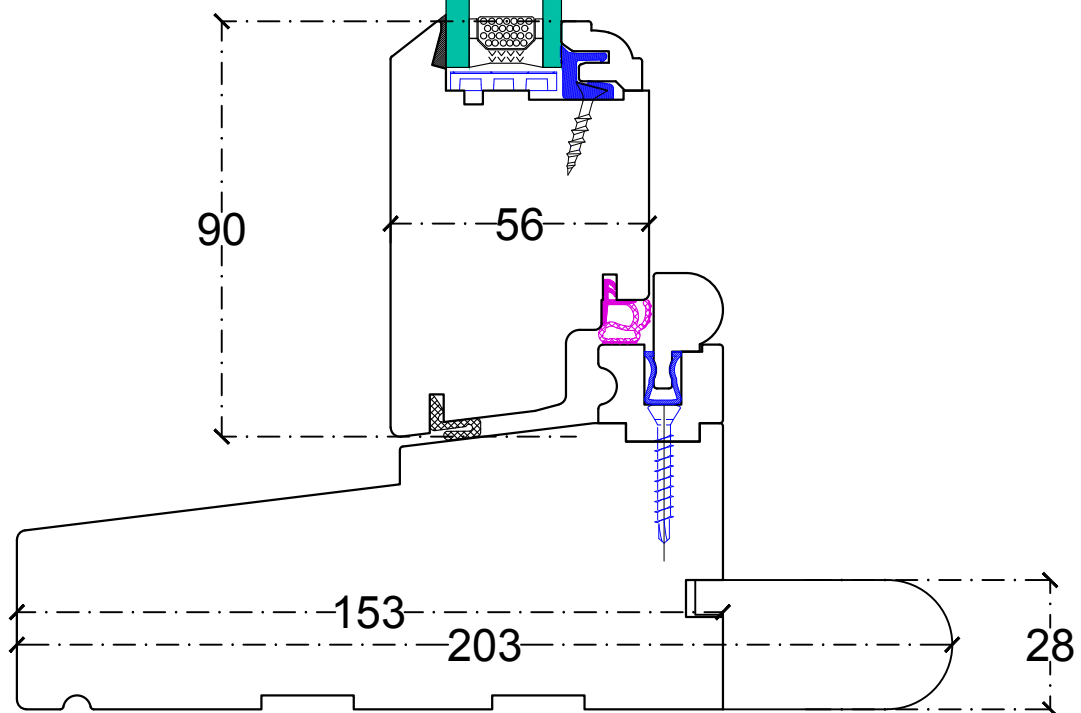
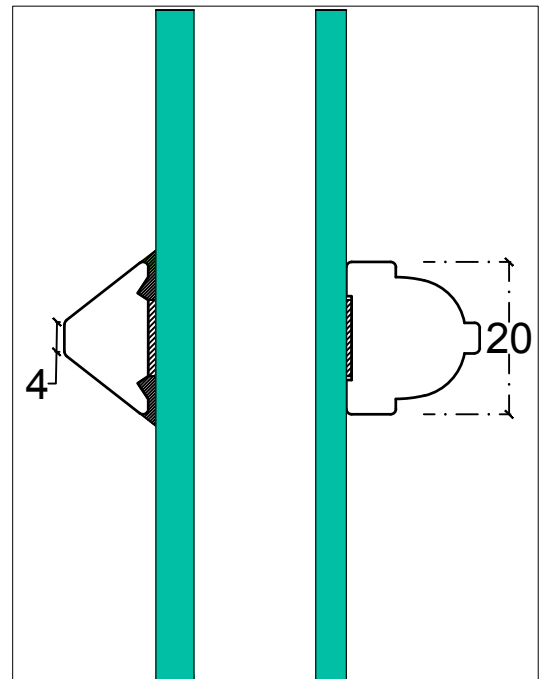
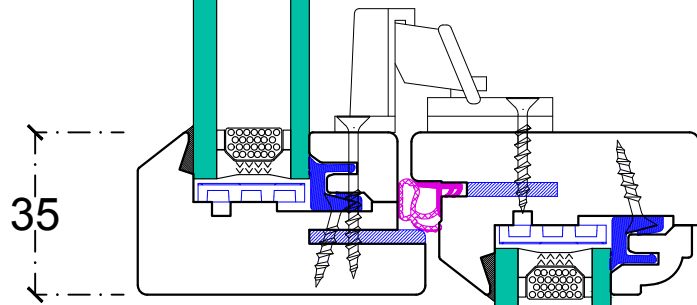
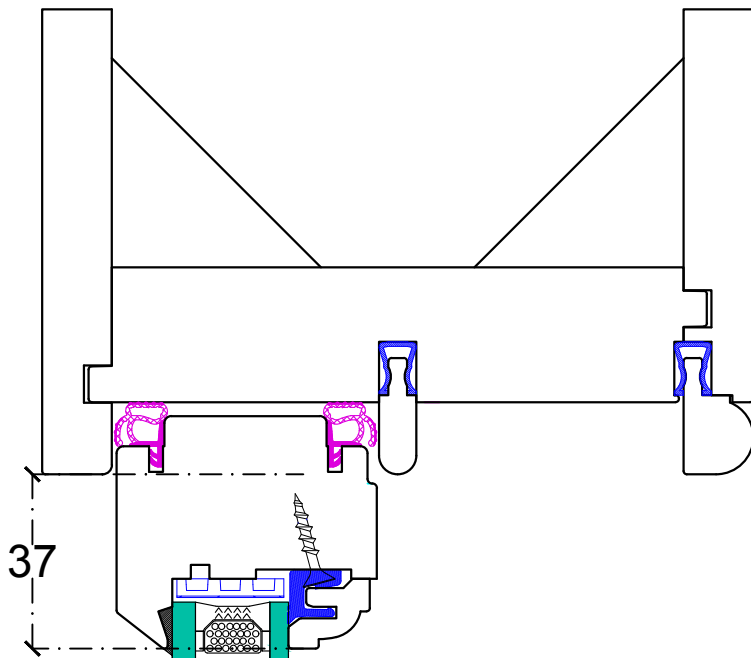

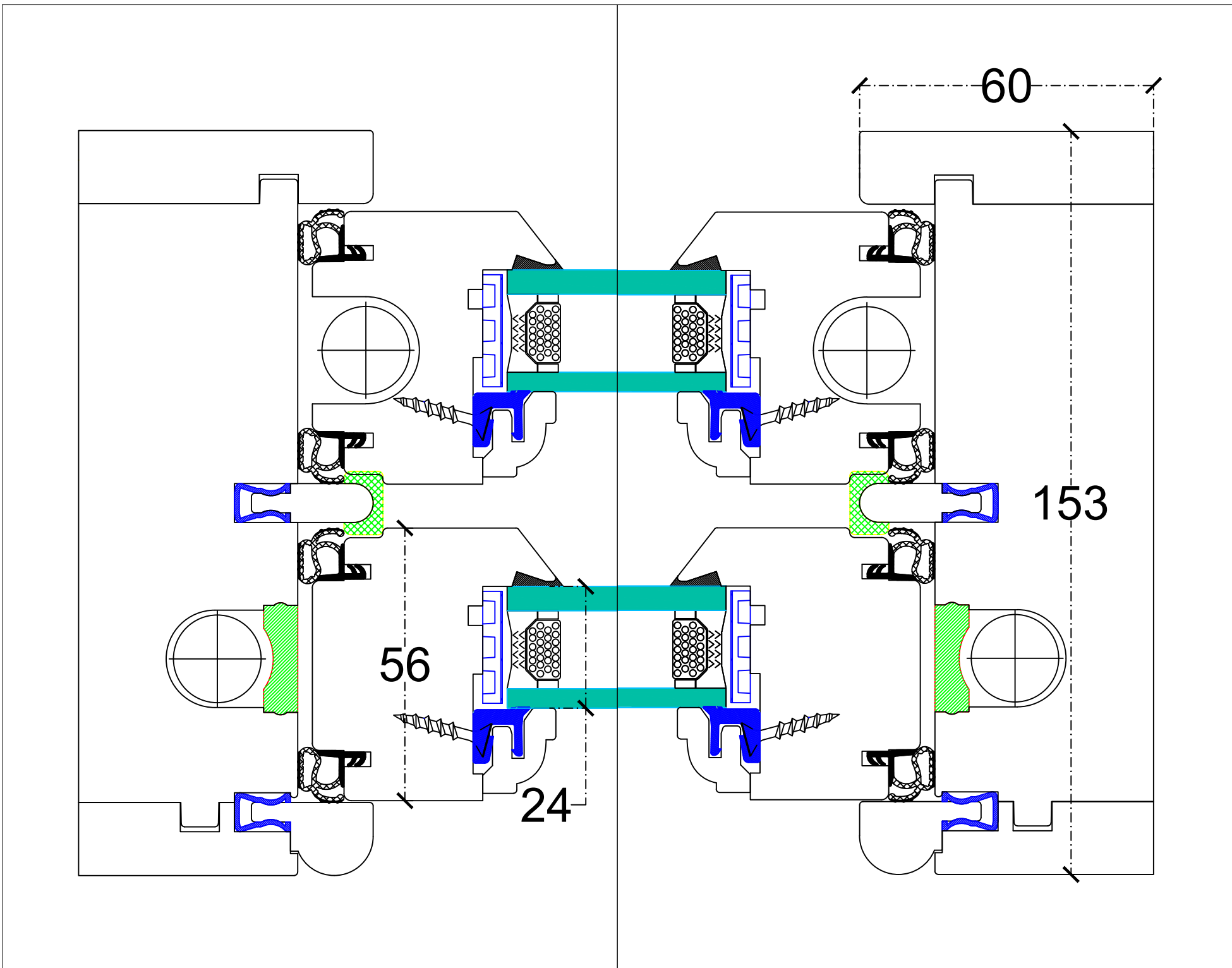

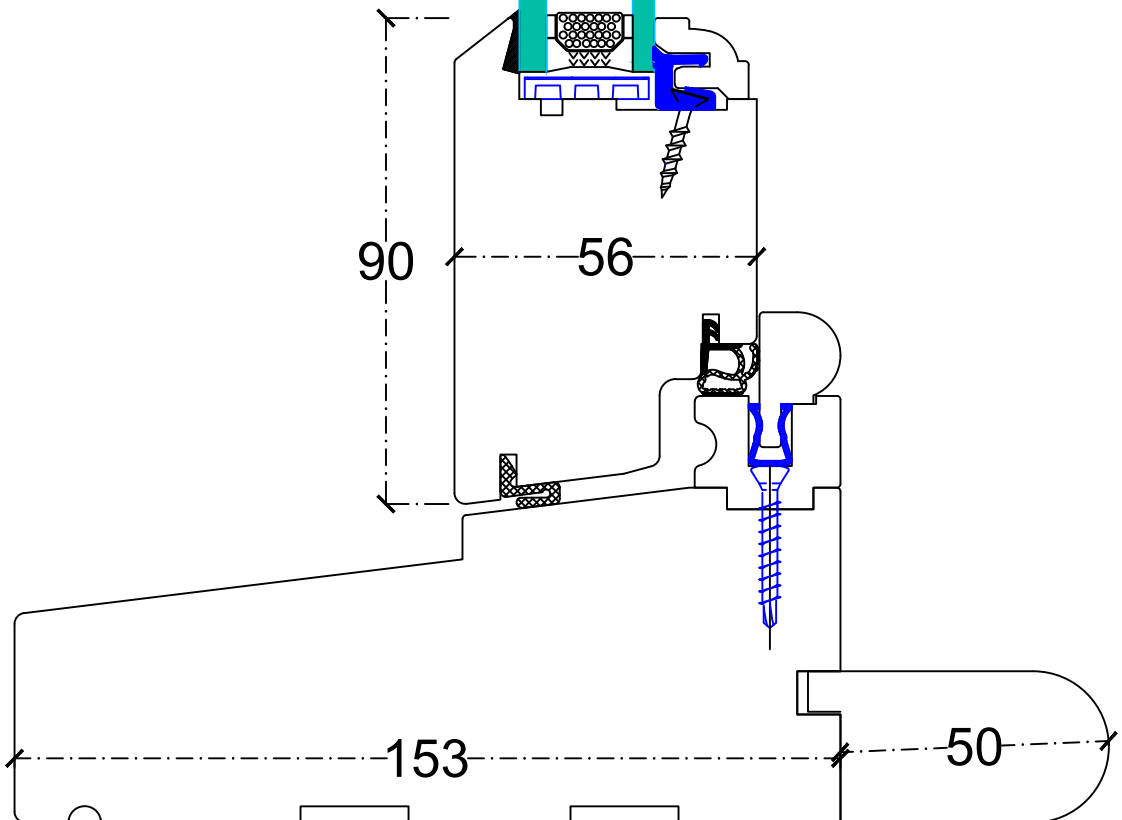
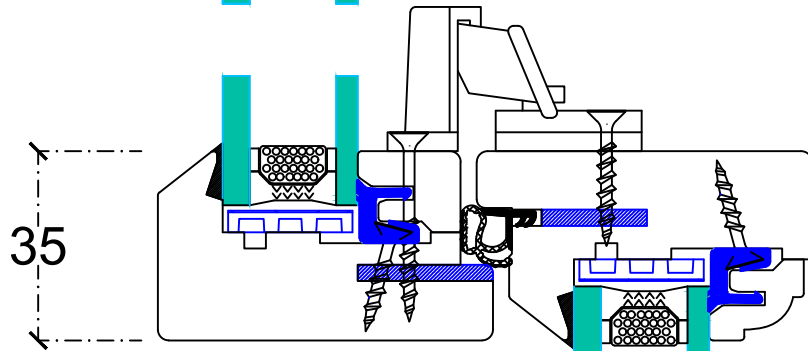
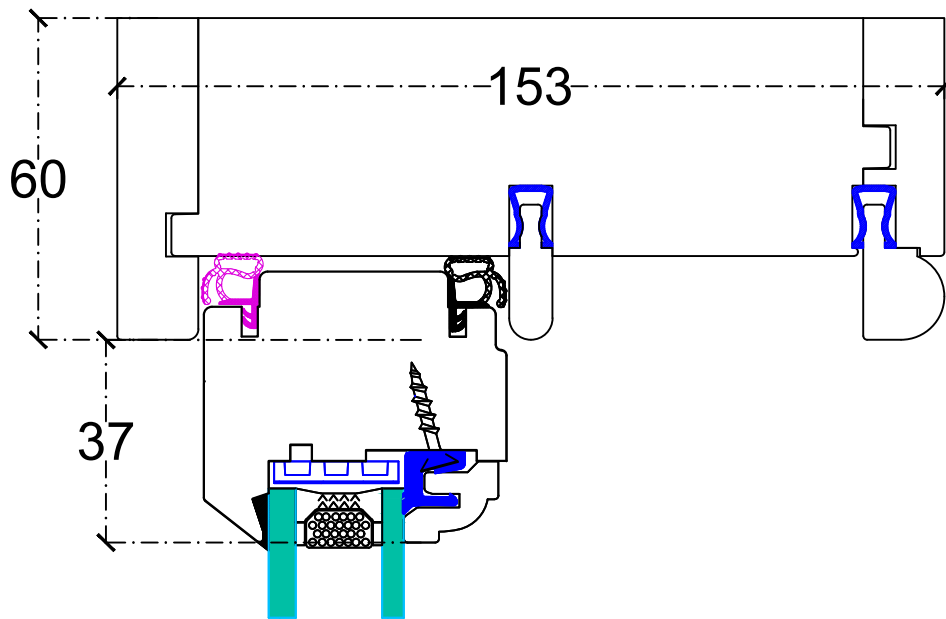

- C1317 -

Rev A
23/09/2021

Seen From Outside

ORIGINAL
SASH

2/20

Rear Elevation - 1st Floor - Office
Spring Balanced Timber Sash Window

TSW05

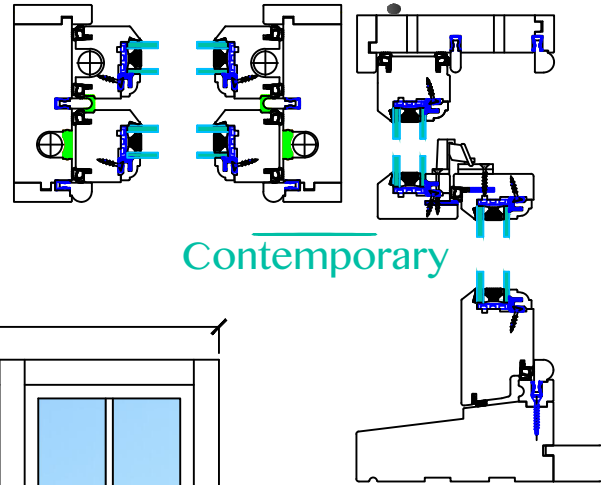

Contemporary

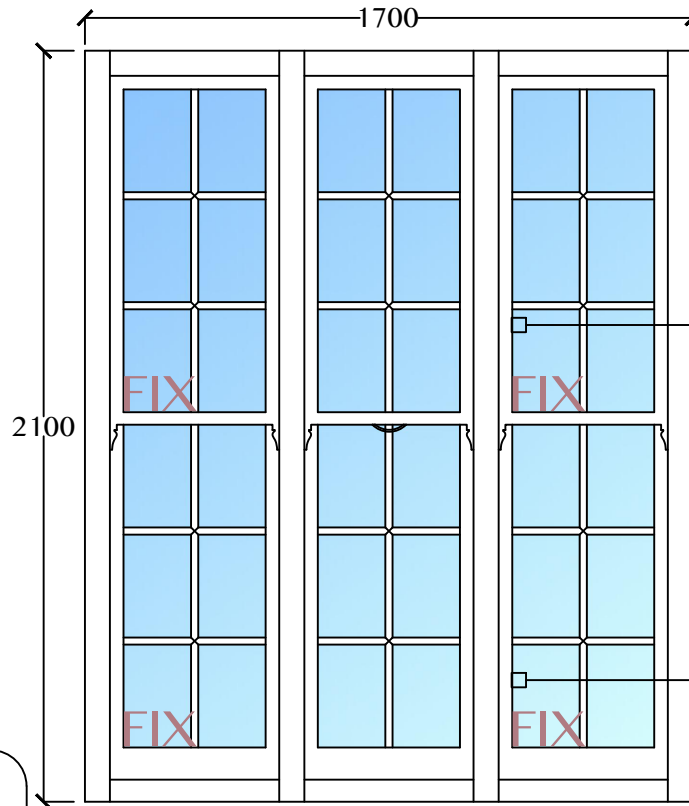

INSIDE LOW E
4 argon 18
15.5 Ar
39.948
OUTSIDE Float

TOUGHENED
INSIDE LOW E
4 argon 18
15.5 Ar
39.948
OUTSIDE Float

Project address:
Doughty Street
WC1N 2PH

1

Client:
Vimal Shah

Paint Details:

remmers
paints

INSIDE: RAL 9016 WHITE

OUTSIDE: RAL 9016 WHITE



REDWOOD

Springs

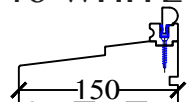

Hardwood
Sapele Sill

Horns:



External Internal

Round
Profile
Internal
Glazing



Ironmongery Finish: SATIN CHROME

2X



Sash Stop

1x



Outside D
Handles



Heritage Lock

2x



Sash Lifts

Notes:

Fitting:

- C1317 -

Rev A
23/09/2021

Seen From Outside

ORIGINAL
SASH

3/20

Rear Elevation - 1st Floor - Office
Timber Casement Window
DCW06

Project address:
Doughty Street
WC1N 2PH

1

Client:
Vimal Shah

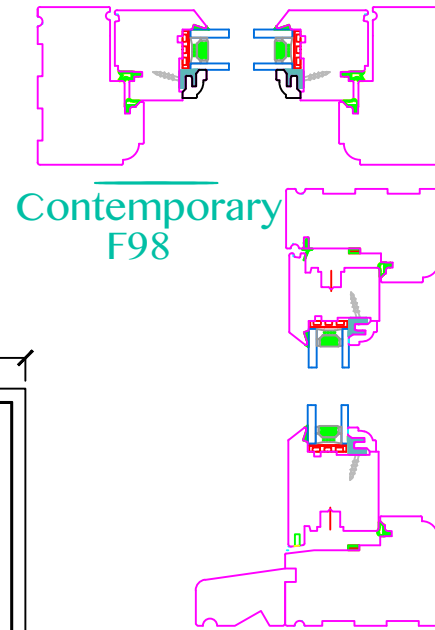

Contemporary
F98

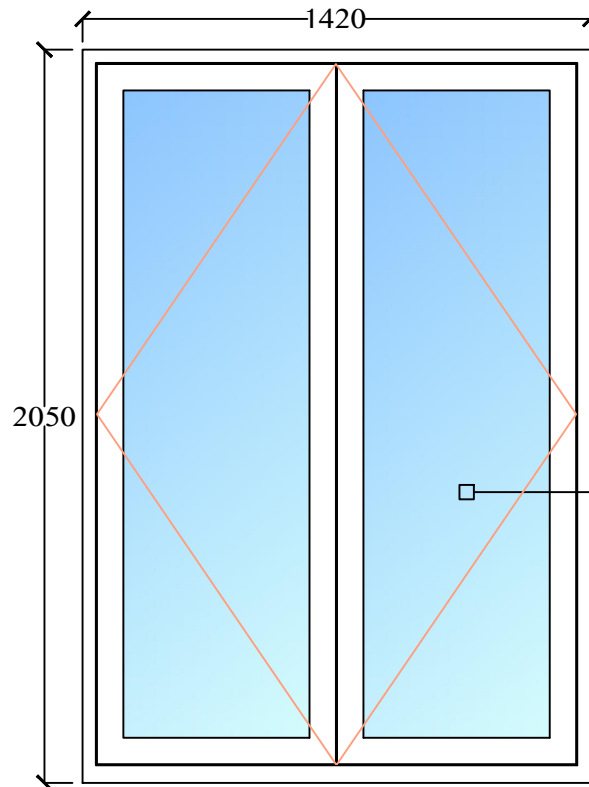

TOUGHENED
INSIDE LOW E
4 argon 18
15.5 Ar
4 39.948
OUTSIDE Float

Paint Details:

remmers
paints

INSIDE: RAL 9016 WHITE

OUTSIDE: RAL 9016 WHITE



REDWOOD

Round
Profile
Internal
Glazing



Multipoint
IPA Espagnolette - Side

Ironmongery Finish: SATIN CHROME

2x
pair

IPA
Adjustable
Friction Stay

4x
pair
/unit
BUTT
Hinges

1x
Forte
Locking
Espagnolette
Handle

Notes:

Fitting:

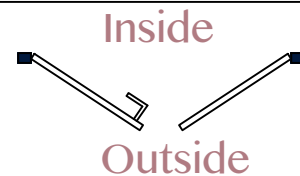

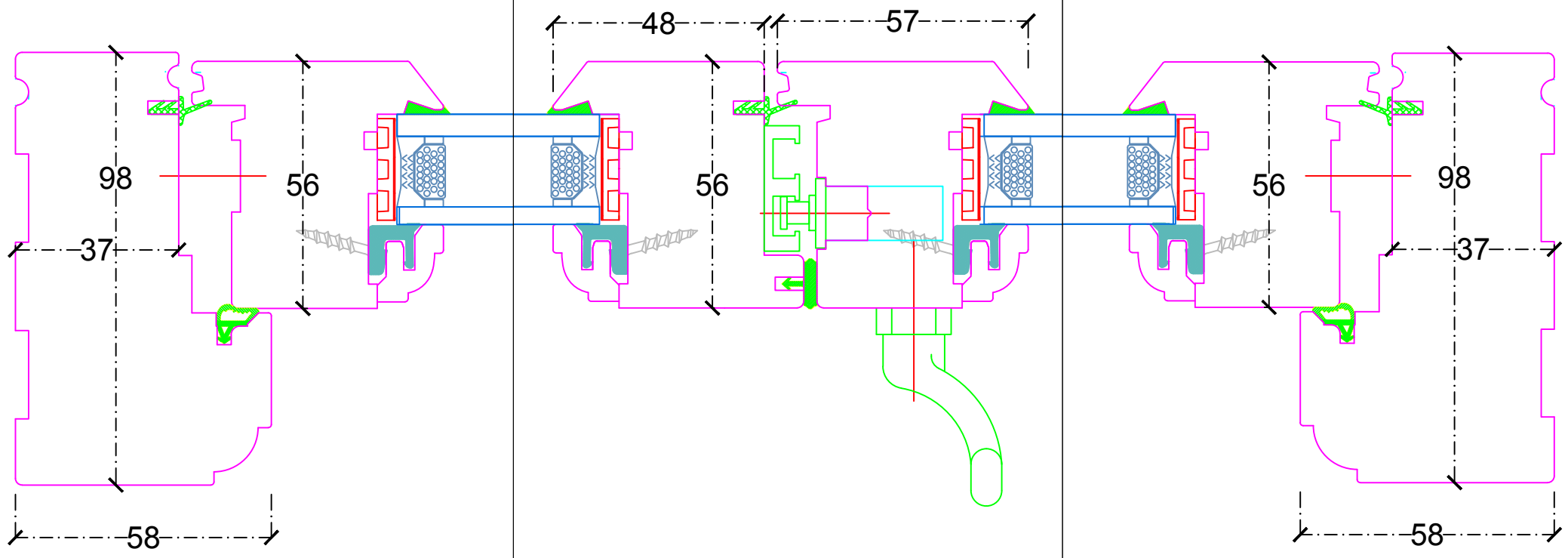

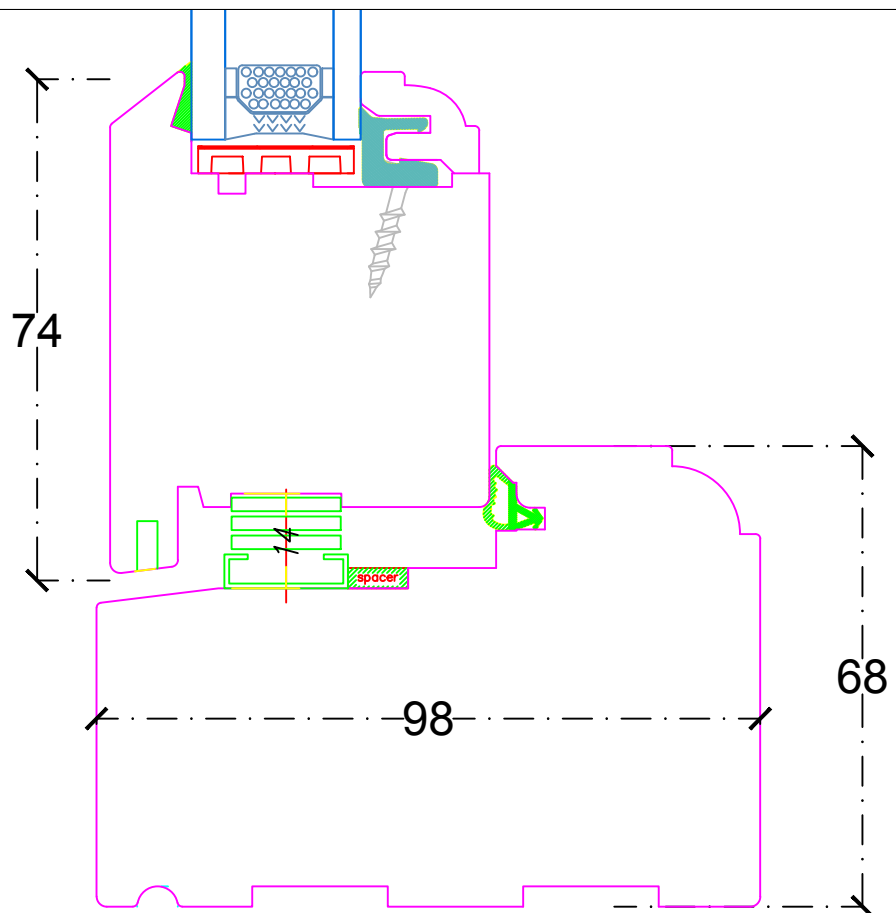
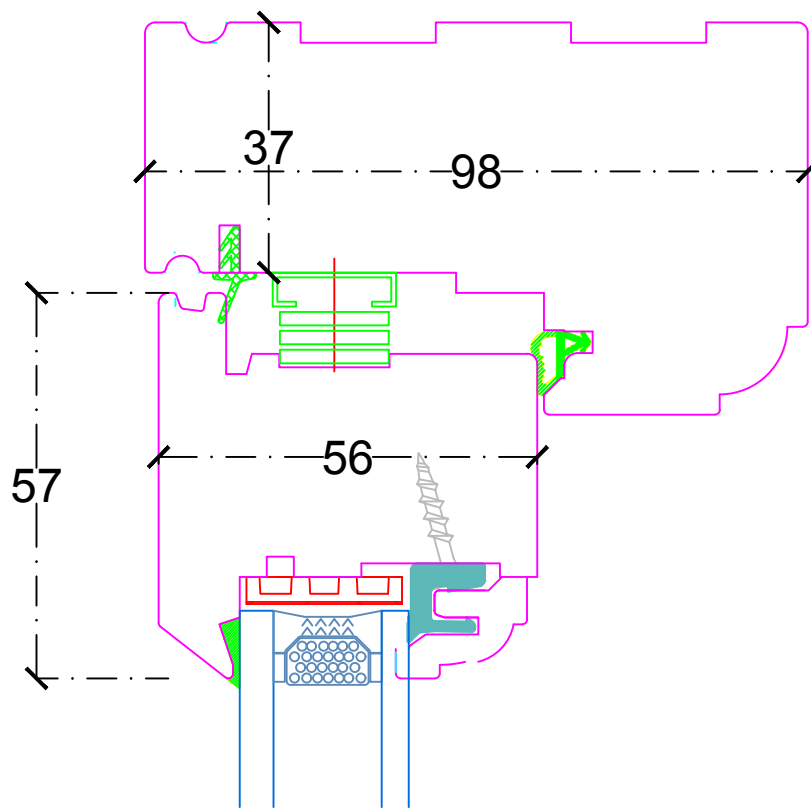

- C1317 -

Rev A
23/09/2021

Seen From Outside

ORIGINAL
SASH

4/20

Rear Elevation - 1st Floor - Office
Timber Casement Window
CW07

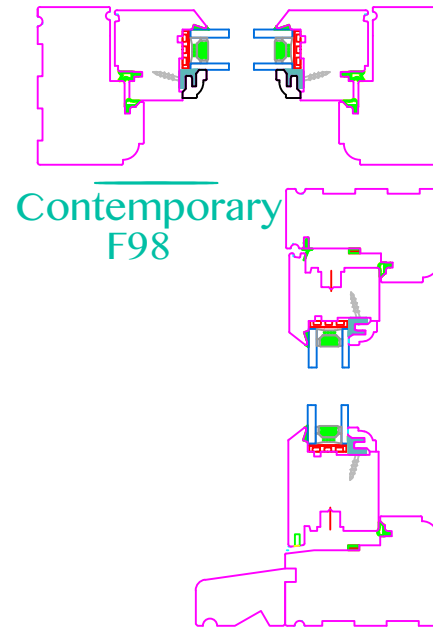

Project address:
Doughty Street
WC1N 2PH

1

Client:
Vimal Shah

Paint Details:

INSIDE: RAL 9016 WHITE

OUTSIDE: RAL 9016 WHITE



REDWOOD

Round
Profile
Internal
Glazing

Multipoint
IPA Espagnolette - Side

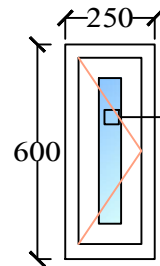

INSIDE LOW E
4 argon 18
15.5 Ar
4 39.948
OUTSIDE Float

Inside
Outside

Notes:
Due to reduced width, the friction stays may not be suitable

Fitting:

Notes:

Fitting:

Ironmongery Finish: SATIN CHROME

1x
pair

IPA
Adjustable
Friction Stay

1x
pair
/unit
BUTT
Hinges

1x
Forte
Locking
Espagnolette
Handle

- C1317 -

Rev A
23/09/2021

Seen From Outside

ORIGINAL
SASH

5/20

Rear Elevation - 1st Floor - Office
Timber Casement Window
CW08

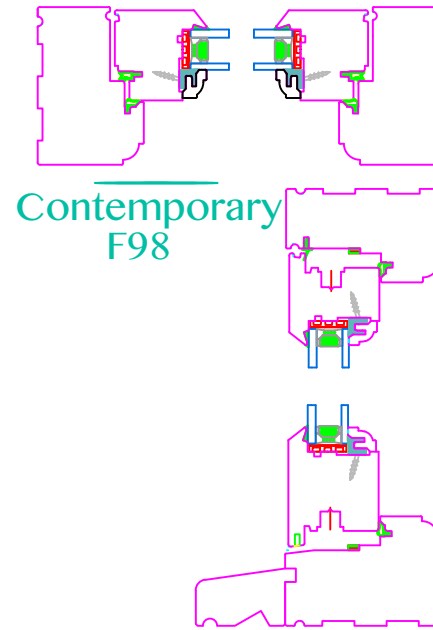

Contemporary
F98

Project address:
Doughty Street
WC1N 2PH

1

Client:
Vimal Shah

Paint Details: 

INSIDE: RAL 9016 WHITE

OUTSIDE: RAL 9016 WHITE



REDWOOD

Round
Profile
Internal
Glazing 

Multipoint
IPA Espagnolette - Side

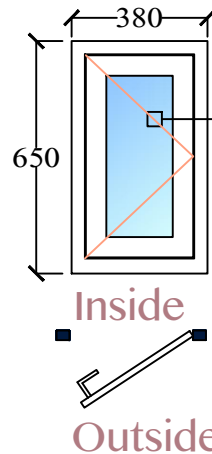

INSIDE LOW E
4 argon 18
15.5 Ar
4 39.948
OUTSIDE Float

Notes:

Fitting:

Notes:

Due to reduced width, the friction stays may not be suitable

Fitting:

Ironmongery Finish: SATIN CHROME

1x
pair

IPA
Adjustable
Friction Stay 

1x
pair
/unit
BUTT
Hinges 

1x
Forte
Locking
Espagnolette
Handle 

- C1317 -

Rev A
23/09/2021

Seen From Outside

ORIGINAL
SASH

6/20

3rd Floor - Flat D
Weight Loaded Timber Sash Window
SW09

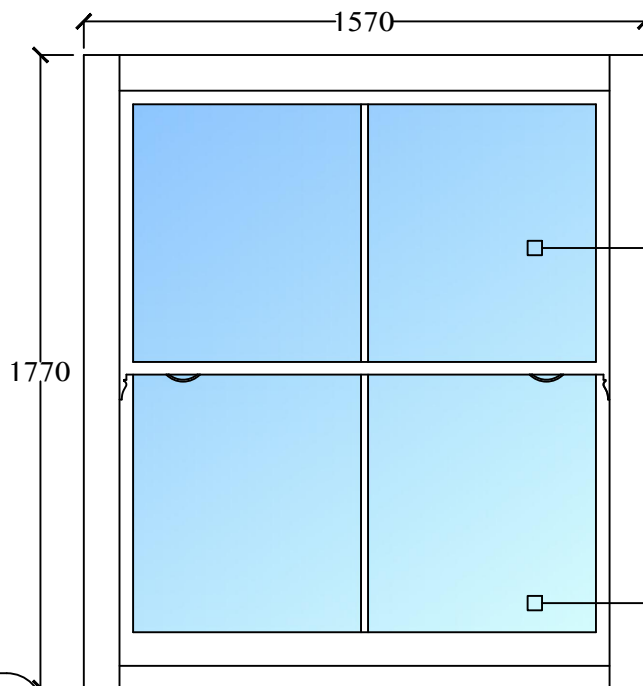
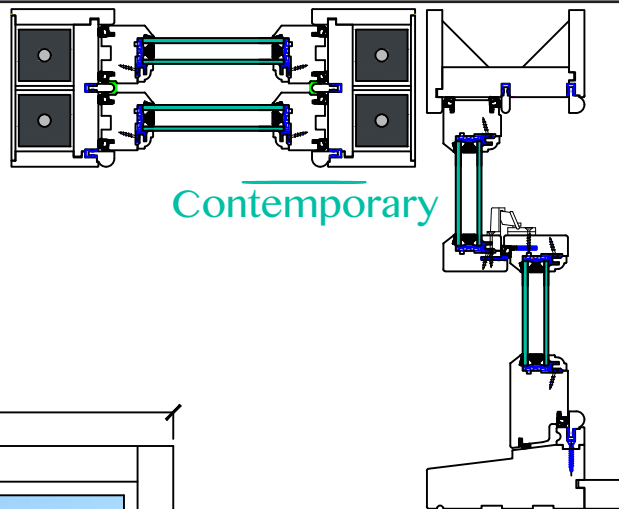

INSIDE LOW E
4 15.5 argon 18 Ar 39.948
4
OUTSIDE Float

TOUGHENED
INSIDE LOW E
4 15.5 argon 18 Ar 39.948
4
OUTSIDE Float

Project address:
Doughty Street
WC1N 2PH

1

Client:
Vimal Shah

Paint Details:

INSIDE: RAL 9016 WHITE

OUTSIDE: RAL 9016 WHITE



REDWOOD

Weights

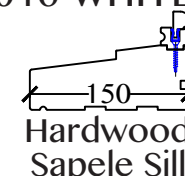

Hardwood
Sapele Sill

Horns:



External



Internal

Round
Profile
Internal
Glazing



Ironmongery Finish: SATIN CHROME

2X



Sash Stop

2X



Heritage Lock

2X



Outside D

4X



Pulleys

2X



Sash Lifts

Notes:
It may require lead weights to
fully open

Fitting:

- C1317 -

Rev A
23/09/2021

Seen From Outside

ORIGINAL
SASH

7/20

3rd Floor - Flat D
Weight Loaded Timber Sash Window
SW10

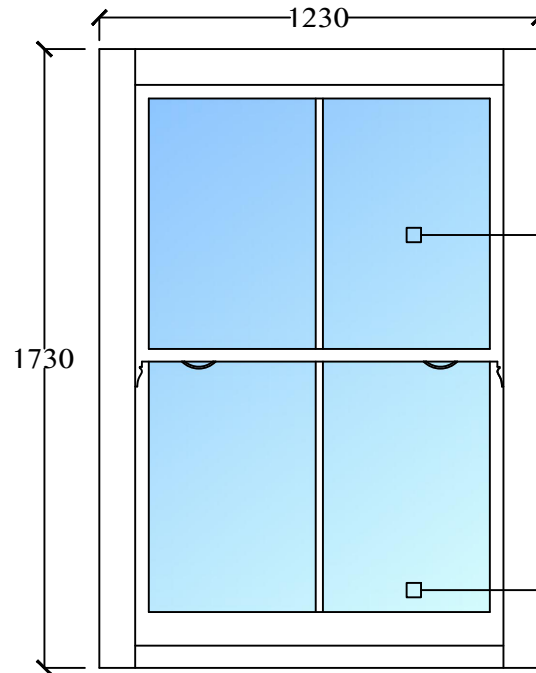
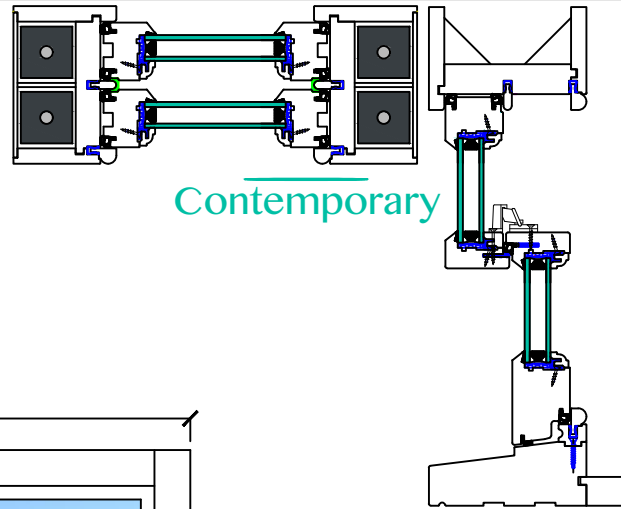

INSIDE LOW E
4 argon 18
15.5 Ar
39.948
OUTSIDE Float

TOUGHENED
INSIDE LOW E
4 argon 18
15.5 Ar
39.948
OUTSIDE Float

Project address:
Doughty Street
WC1N 2PH

1

Client:
Vimal Shah

Paint Details:

INSIDE: RAL 9016 WHITE

OUTSIDE: RAL 9016 WHITE

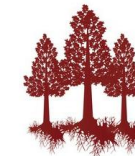

REDWOOD

Weights

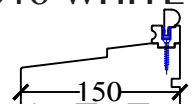

150
Hardwood
Sapele Sill

Horns:



External



Internal

Round
Profile
Internal
Glazing



Ironmongery Finish: SATIN CHROME

2X



Sash Stop

2X



Heritage Lock

2X



Outside D

4X



Pulleys

2X



Sash Lifts

Notes:

Fitting:

- C1317 -

Rev A
23/09/2021

Seen From Outside

ORIGINAL
SASH

8/20

3rd Floor - Flat D
Weight Loaded Timber Sash Window
SW11

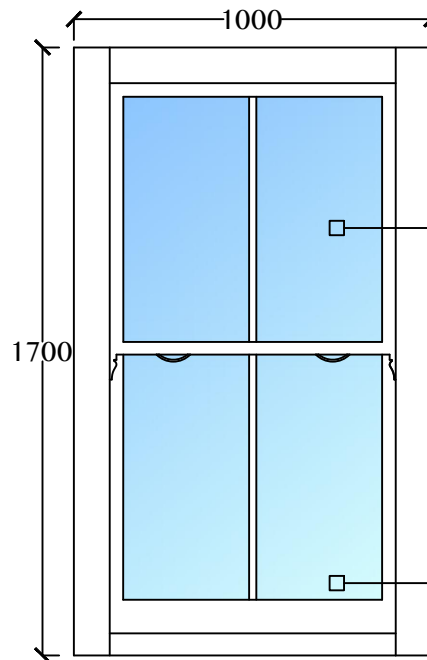
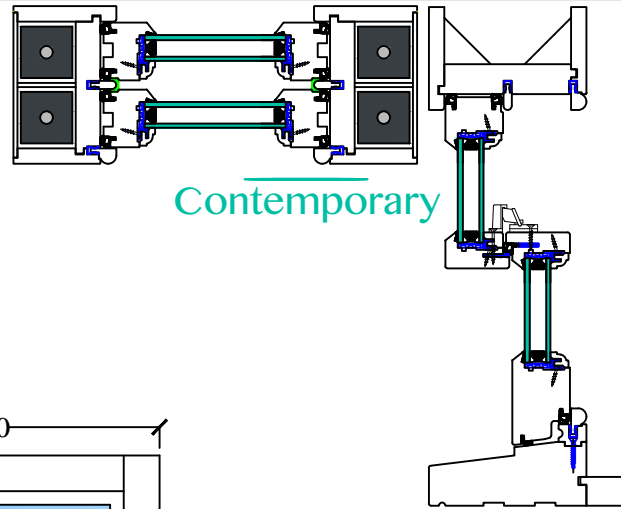

INSIDE **LOW E**
4 argon 18
15.5 Ar
39.948
OUTSIDE **Float**

TOUGHENED
INSIDE **LOW E**
4 argon 18
15.5 Ar
39.948
OUTSIDE **Float**

Project address:
Doughty Street
WC1N 2PH

1

Client:
Vimal Shah

Paint Details:

INSIDE: RAL 9016 WHITE

OUTSIDE: RAL 9016 WHITE



REDWOOD

Weights

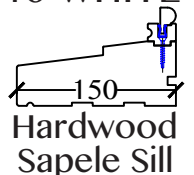

Horns:

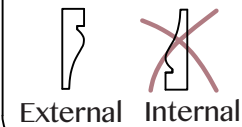

Ironmongery Finish: SATIN CHROME

2X



Sash Stop



Heritage Lock

2X



Outside D

4X



Pulleys

2X



Sash Lifts

Notes:

Fitting:

- C1317 -

Rev A
23/09/2021

Seen From Outside

ORIGINAL
SASH

9/20

3rd Floor - Flat D
Weight Loaded Timber Sash Window
SW12

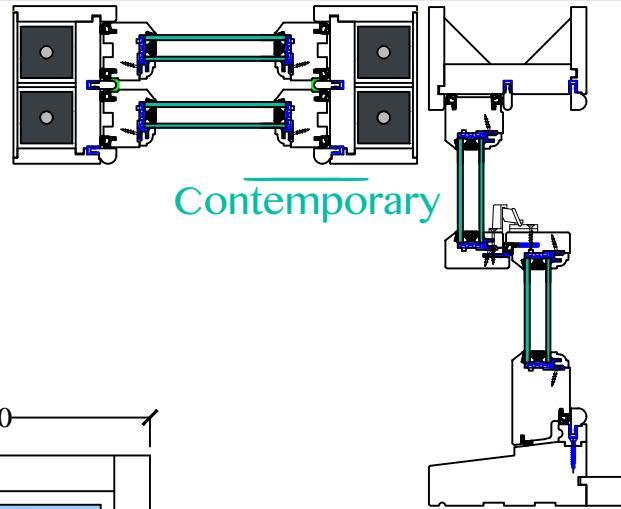

Contemporary

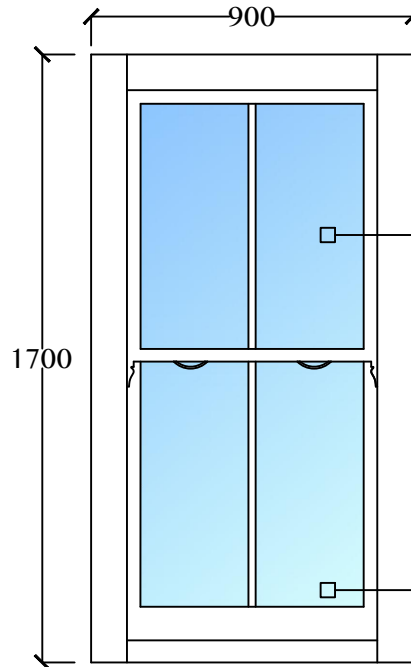

INSIDE **LOW E**
4 argon 18
15.5 Ar
39.948
OUTSIDE **Float**

TOUGHENED
INSIDE **LOW E**
4 argon 18
15.5 Ar
39.948
OUTSIDE **Float**

Project address:
Doughty Street
WC1N 2PH

1

Client:
Vimal Shah

Paint Details:

INSIDE: RAL 9016 WHITE

OUTSIDE: RAL 9016 WHITE

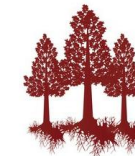

REDWOOD

Weights

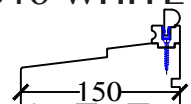
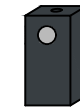

Hardwood
Sapele Sill

Horns:



External



Internal

Round
Profile
Internal
Glazing



Ironmongery Finish: SATIN CHROME

2X



Sash Stop



Heritage Lock

2X



Outside D

4X



Pulleys

2X



Sash Lifts

Notes:

Fitting:

C1317

Rev A
23/09/2021

Seen From Outside

ORIGINAL
SASH

10/20

Flat F
Weight Loaded Timber Sash Window
SW13
SW14

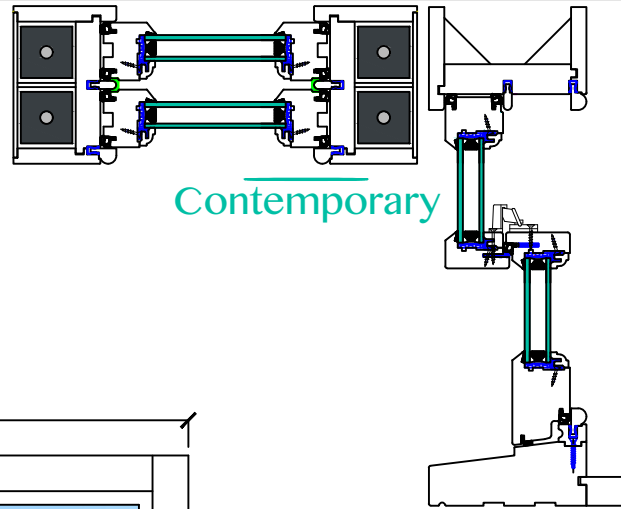

Project address:
Doughty Street
WC1N 2PH

1

Client:
Vimal Shah

Paint Details:

INSIDE: RAL 9016 WHITE

OUTSIDE: RAL 9016 WHITE

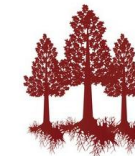

REDWOOD

Weights

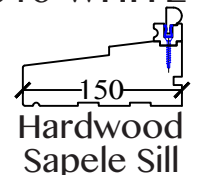

Hardwood
Sapele Sill

Horns:



External



Internal

Round
Profile
Internal
Glazing

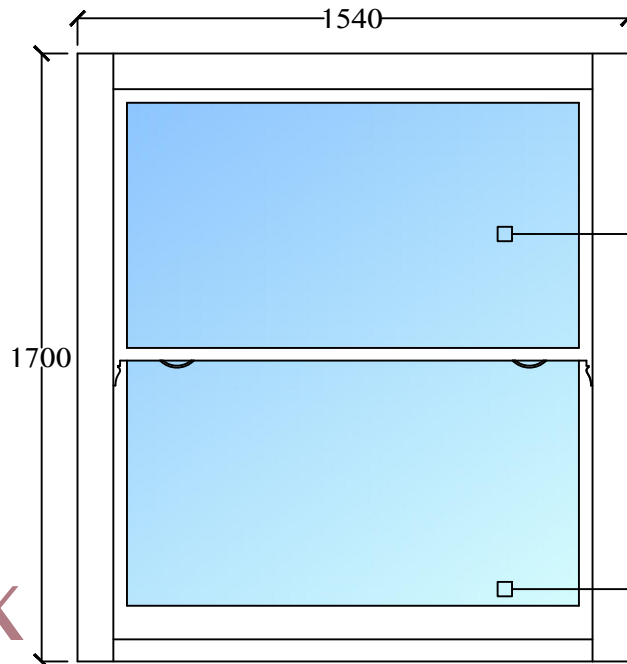

INSIDE LOW E
4 argon 18
15.5 Ar
4 39.948
OUTSIDE Float

TOUGHENED
INSIDE LOW E
4 argon 18
15.5 Ar
4 39.948
OUTSIDE Float

Ironmongery Finish: SATIN CHROME

2X



Sash Stop

2X



Heritage Lock

2X



Outside D

4X



Pulleys

2X



Sash Lifts

Notes:
It may require lead weights to
fully open

Fitting:

- C1317 -

Rev A
23/09/2021

Seen From Outside

ORIGINAL
SASH

11/20

Flat F
Weight Loaded Timber Sash Window
SW15

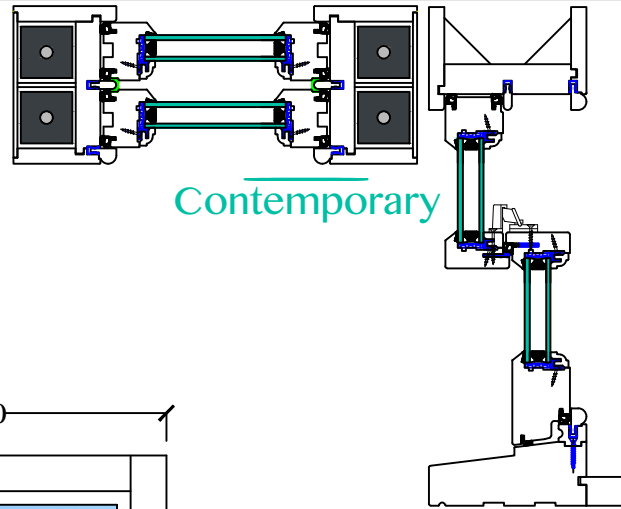

Project address:
Doughty Street
WC1N 2PH

1

Client:
Vimal Shah

Paint Details:

INSIDE: RAL 9016 WHITE

OUTSIDE: RAL 9016 WHITE

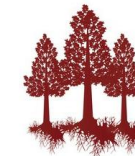

REDWOOD

Weights

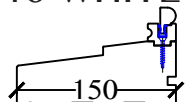

Hardwood
Sapele Sill

INSIDE LOW E
4 argon 18
15.5 Ar
4 39.948
OUTSIDE Float

TOUGHENED
INSIDE LOW E
4 argon 18
15.5 Ar
4 39.948
OUTSIDE Float

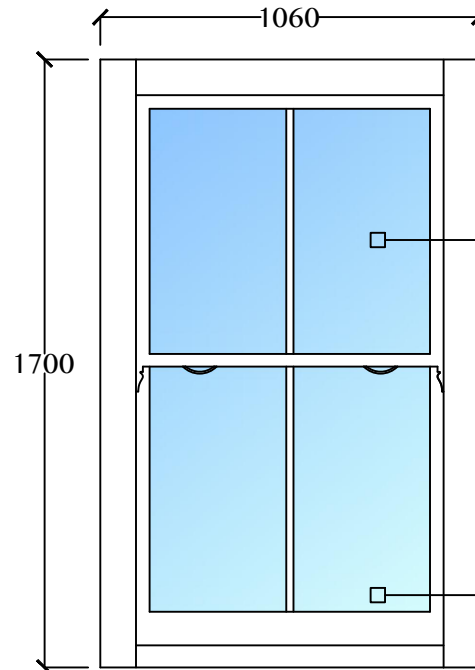

Horns:



External



Internal

Round
Profile
Internal
Glazing



Ironmongery Finish: SATIN CHROME

2X



Sash Stop



Heritage Lock

2X



Outside D

4X



Pulleys

2X



Sash Lifts

Notes:

Fitting:

- C1317 -

Rev A
23/09/2021

Seen From Outside

ORIGINAL
SASH

12/20

Flat F
Weight Loaded Timber Sash Window
SW16

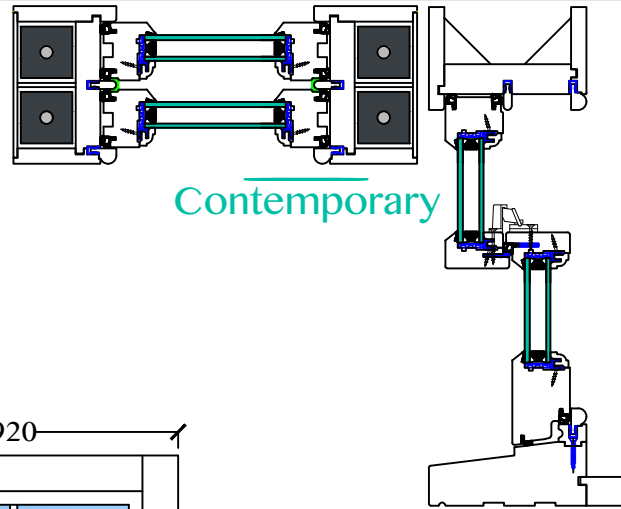

Contemporary

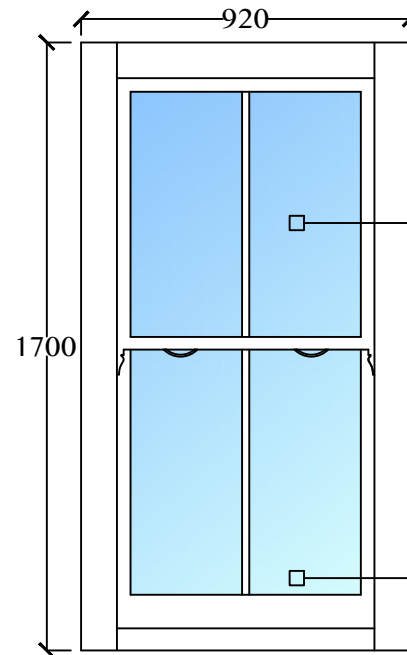

INSIDE LOW E
4 argon 18
15.5 Ar
39.948
OUTSIDE Float

TOUGHENED
INSIDE LOW E
4 argon 18
15.5 Ar
39.948
OUTSIDE Float

Project address:
Doughty Street
WC1N 2PH

1

Client:
Vimal Shah

Paint Details:

INSIDE: RAL 9016 WHITE

OUTSIDE: RAL 9016 WHITE



REDWOOD

Weights

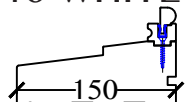

Hardwood
Sapele Sill

Horns:



External Internal

Round
Profile
Internal
Glazing



Ironmongery Finish: SATIN CHROME

2X



Sash Stop



Heritage Lock

2X



Outside D

4X



Pulleys

2X



Sash Lifts

Notes:

Fitting:

- C1317 -

Rev A
23/09/2021

Seen From Outside

ORIGINAL
SASH

13/20

Flat E
Weight Loaded Timber Sash Window

SW17
SW18

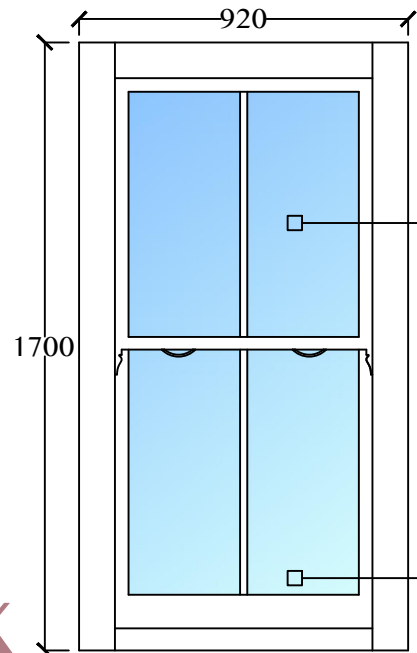
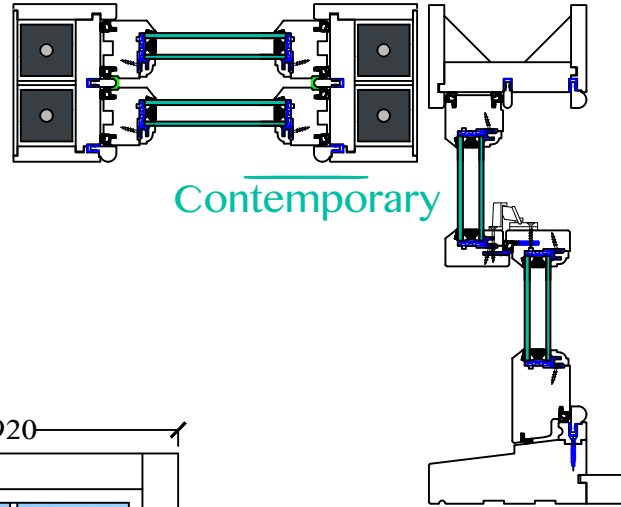

2x

INSIDE **LOW E**
4 argon 18
15.5 Ar
39.948
OUTSIDE **Float**

TOUGHENED
INSIDE **LOW E**
4 argon 18
15.5 Ar
39.948
OUTSIDE **Float**

Project address:
Doughty Street
WC1N 2PH

1

Client:
Vimal Shah

Paint Details: **remmers**
paints

INSIDE: RAL 9016 WHITE

OUTSIDE: RAL 9016 WHITE



REDWOOD

Weights

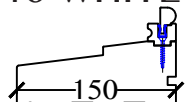

Hardwood
Sapele Sill

Horns:



External Internal

Round
Profile
Internal
Glazing



Ironmongery Finish: **SATIN CHROME**

2X



Sash Stop



Heritage Lock

2X



Outside D

4X



Pulleys

2X



Sash Lifts

Notes:

Fitting:

- C1317 -

Rev A
23/09/2021

Seen From Outside

ORIGINAL
SASH

14/20

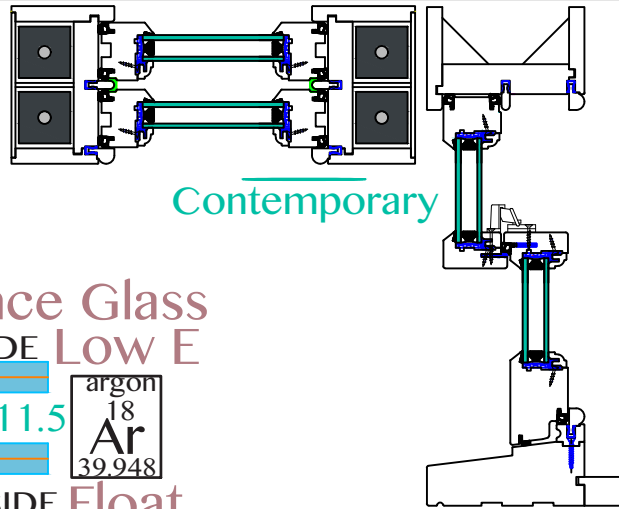
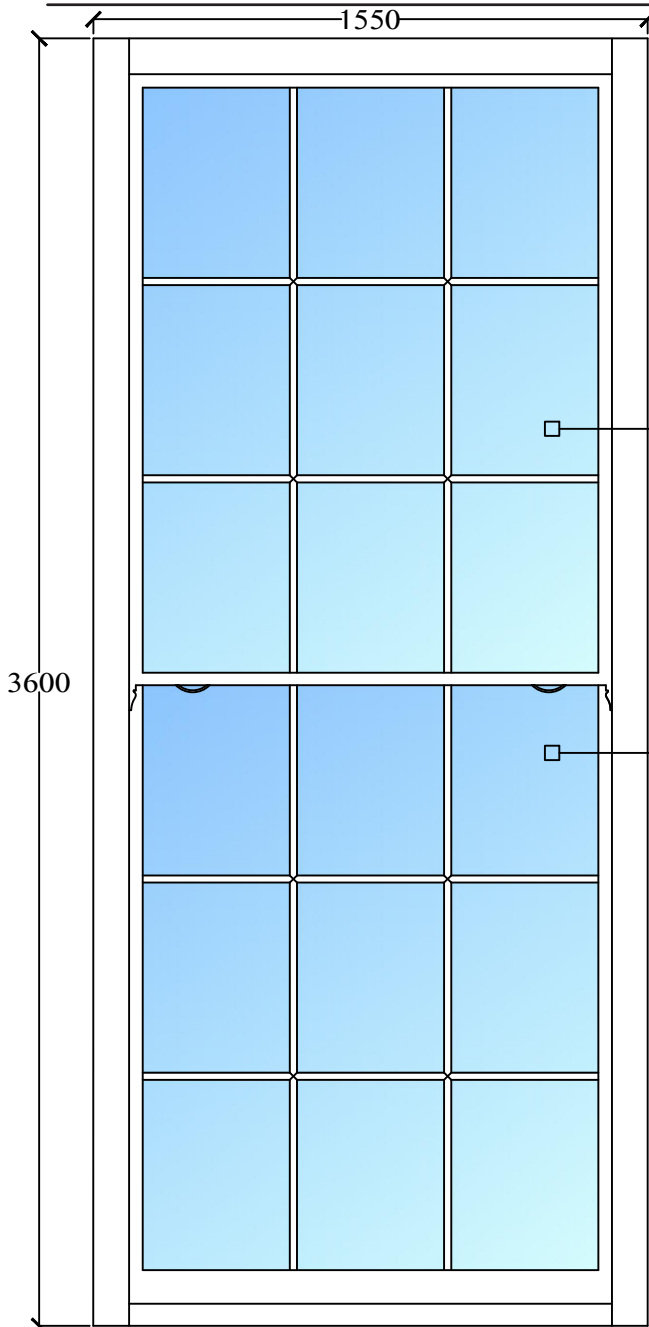

Silence Glass
INSIDE LOW E
3.1.3 11.5
3.1.3 11.5
OUTSIDE Float
Silence Glass

Silence Glass
INSIDE LOW E
3.1.3 11.5
3.1.3 11.5
OUTSIDE Float
Silence Glass

argon
18
Ar
39.948

argon
18
Ar
39.948

Stairs
Weight Loaded Timber Sash Window
SW19

To be delivered by pieces

Project address:
Doughty Street
WC1N 2PH

1

Client:
Vimal Shah

Paint Details:

INSIDE: RAL 9016 WHITE

OUTSIDE: RAL 9016 WHITE



REDWOOD

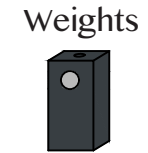

Weights
150
Hardwood
Sapele Sill

Horns:



External



Internal

Round
Profile
Internal
Glazing



Ironmongery Finish: SATIN CHROME

2X



Sash Stop

2X



Heritage Lock

2X



Outside D

4X



Pulleys

2X



Sash Lifts

- C1317 -

Rev A
23/09/2021

Seen From Outside

ORIGINAL
SASH

15/20

Second Floor - Flat B
Weight Loaded Timber Sash Window

SW21
SW22
SW23

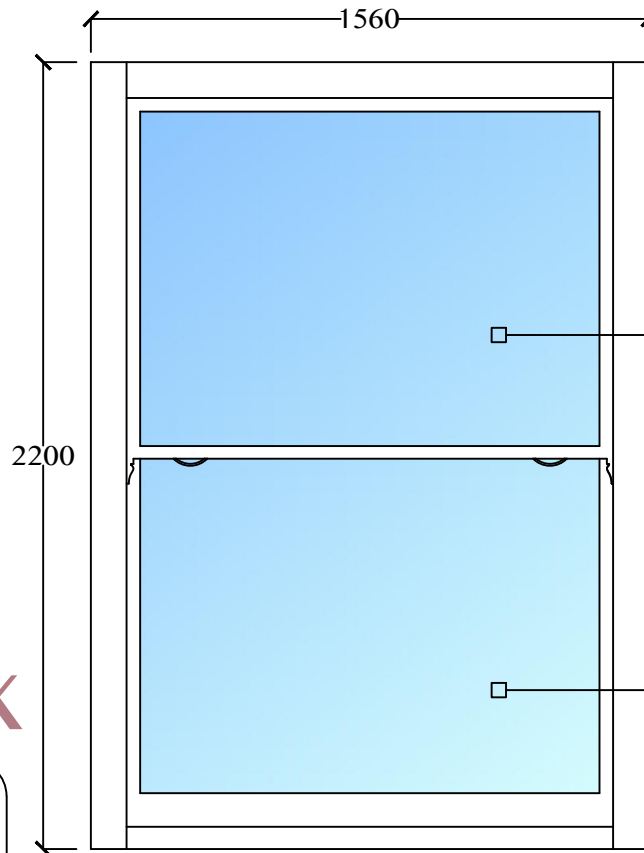
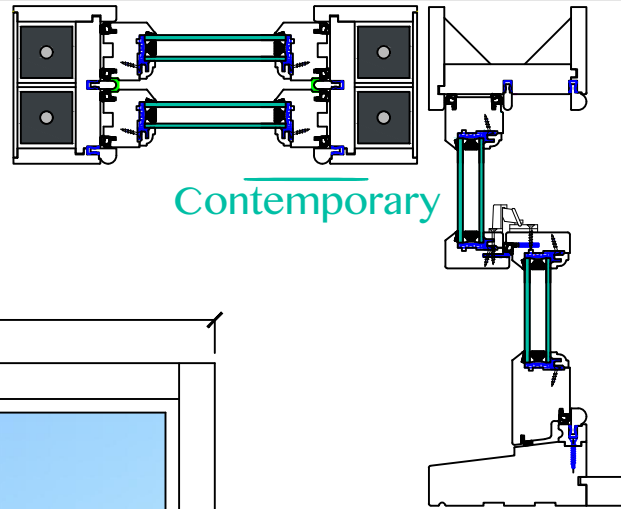

INSIDE **LOW E**
4 15.5 argon 18 Ar 39.948
4
OUTSIDE **Float**

TOUGHENED
INSIDE **LOW E**
4 15.5 argon 18 Ar 39.948
4
OUTSIDE **Float**

Project address:
Doughty Street
WC1N 2PH

1

Client:
Vimal Shah

Paint Details:

INSIDE: RAL 9016 WHITE

OUTSIDE: RAL 9016 WHITE

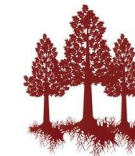

REDWOOD

Weights

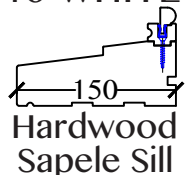

Horns:

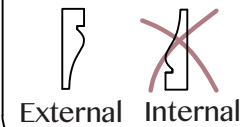

Round
Profile
Internal
Glazing

Ironmongery Finish: SATIN CHROME

2X



Sash Stop

2X



Heritage Lock

2X



Outside D

4X



Pulleys

2X



Sash Lifts

Notes:

Fitting: