

# PLANNING ISSUE

Check all dimensions on site. Do not scale off drawings without prior consultation. Any discrepancies to be reported to architects before execution of relevant works. This drawing has been produced for Formal Investments for the works at Regency Lodge, NW3 and for that application alone and is not intended for use by any other person or for any other purpose. Drawings remain copyright of Hayhurst and Co. and may not be reproduced without written consent of licence.

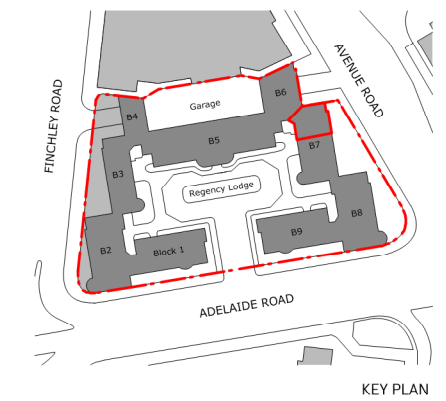

NOTE: glazing bars are non-structural

NOTE: window frames to be made from powder-coated aluminium with polyamide thermal break

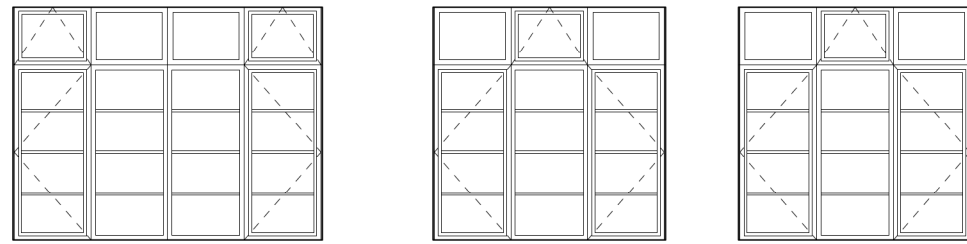

1 Proposed Windows - East facing  
1:50

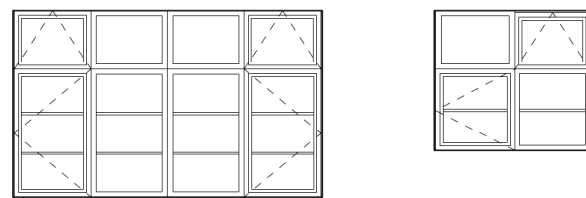

2 Proposed Windows - North facing  
1:50

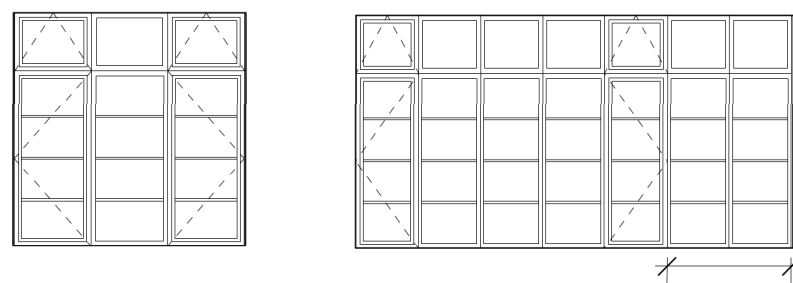

NOTE: bay windows are faceted and arranged along a curve, elevations show individual unfolded arrangement

3 Proposed Windows - West facing  
1:50

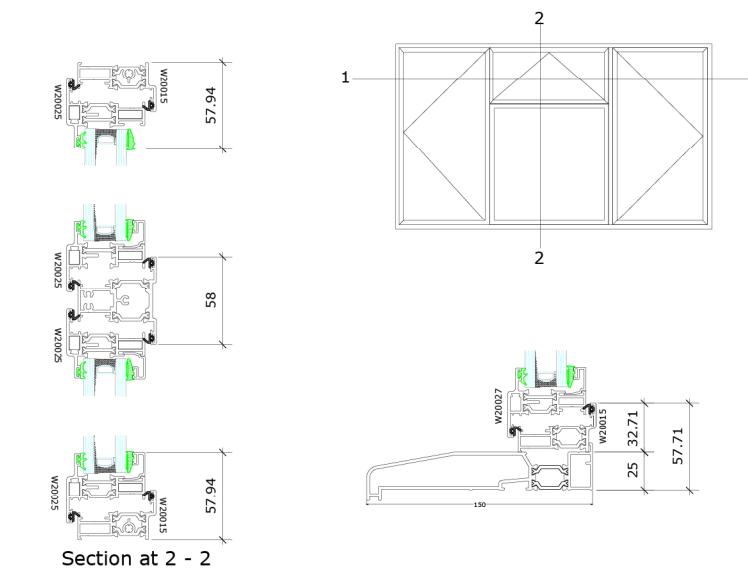

Section at 2 - 2

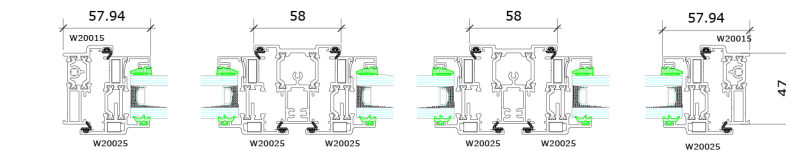

Section at 1 - 1

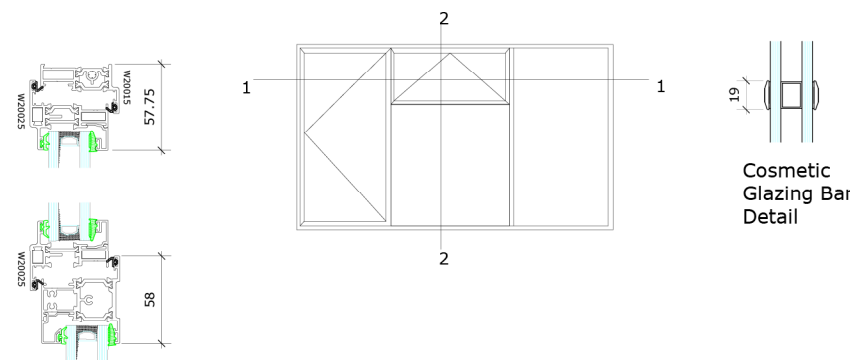

Cosmetic Glazing Bar Detail

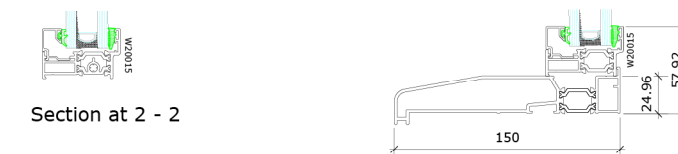

Section at 2 - 2

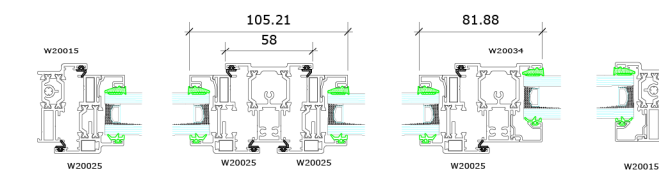

Section at 1 - 1

4 Everglade aluminium frame details  
1:5

Issue/Revision ↑ Date ↑ Rev ↑

Hayhurst & Co Architects  
26 Fournier Street, London, E1 6QE  
+44 (0) 20 7247 4028  
mail@hayhurstand.co.uk  
www.hayhurstand.co.uk

Project: **Window Replacement**  
Address: **Flat 81, Regency Lodge, London, NW3 5EB**  
Subject: **Fenestration Elevations - Proposed**

Date: **15.07.22**

Scale: **1:50**

Original size: **A3**

Drawing no: **301(F81) A200 -**