

**Please Note**

The Above is a Selection of the Most Popular Straight Run Configurations. These are Available Either Open Out or Open In. The ● Configurations Can Also Be Supplied Opposite Hand. Corner and Faceted Curved Options are Also Available

Description **SF75**

**Thermally Broken Aluminium Folding Sliding Door System Configuration Options**

Detail No: **SF75-00**

System: **SF75** **A**

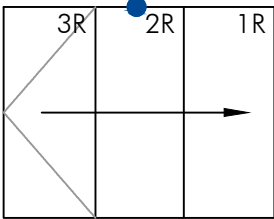

OUTSIDE

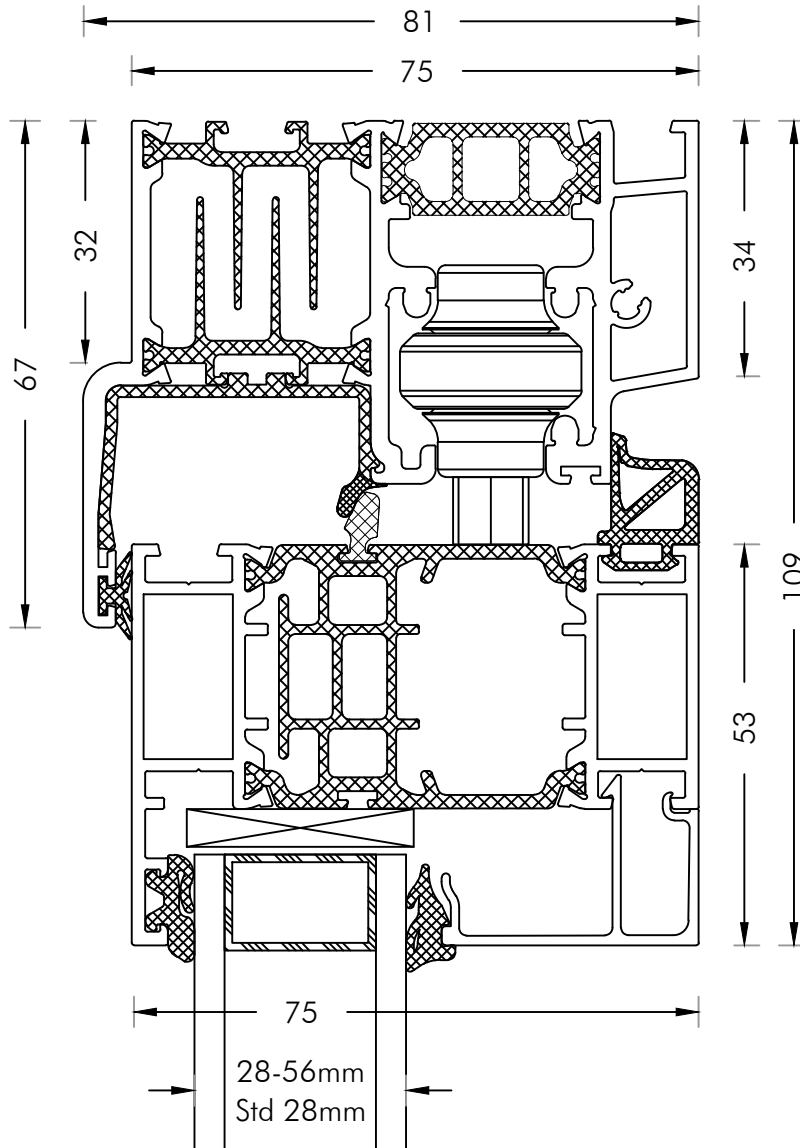

INSIDE

Description **Vertical Section - Connection**  
**Top Track - Panel / Open In**

Detail No: **SF75-01**

System: **SF75**

**A**

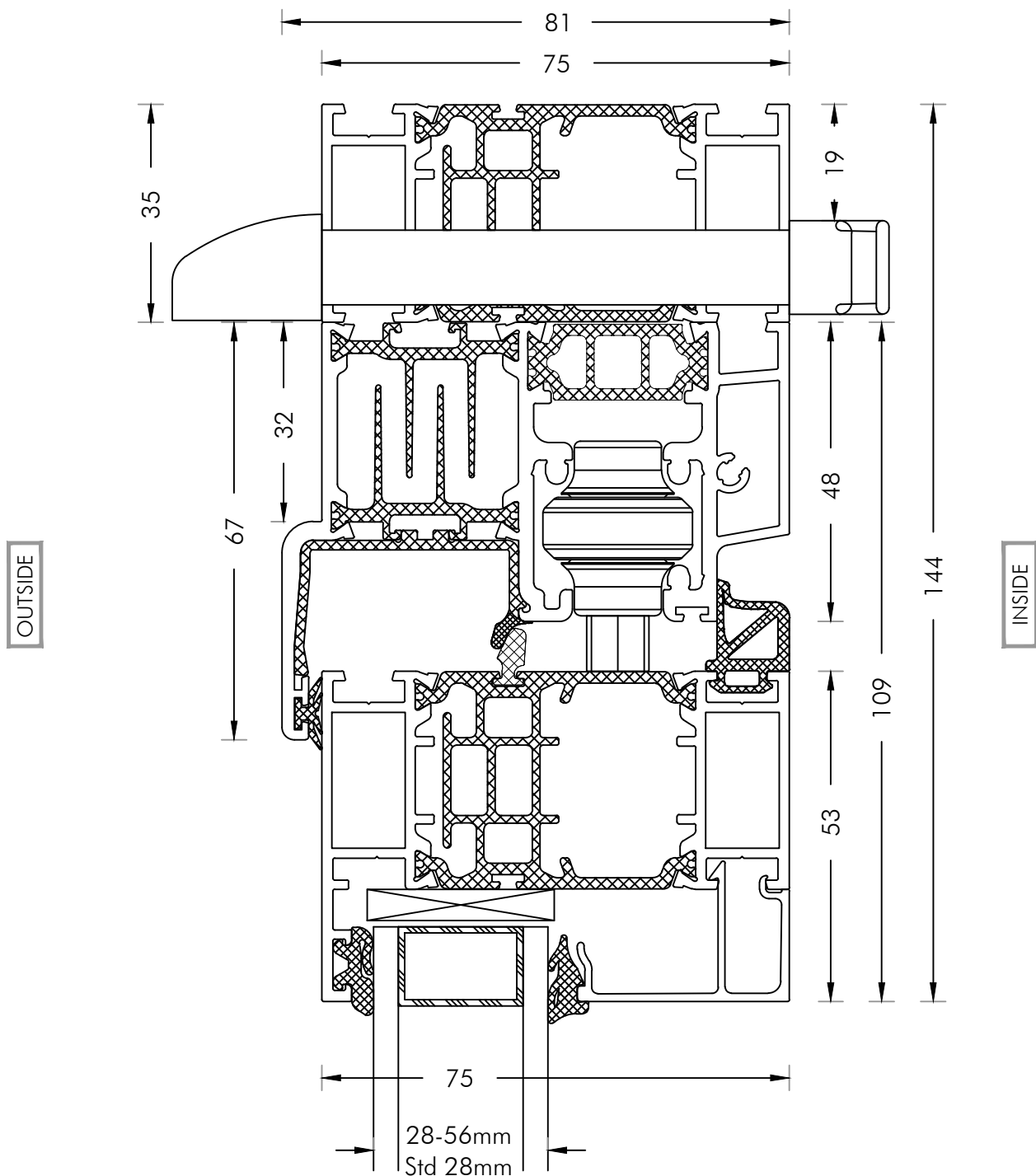
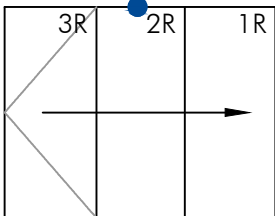

Description **Vertical Section - Connection**  
**Top Track With 40mm Extension And Trickle Vent - Panel /**  
**Open In**

Detail No: **SF75-01TV**

System: **SF75**

**A**

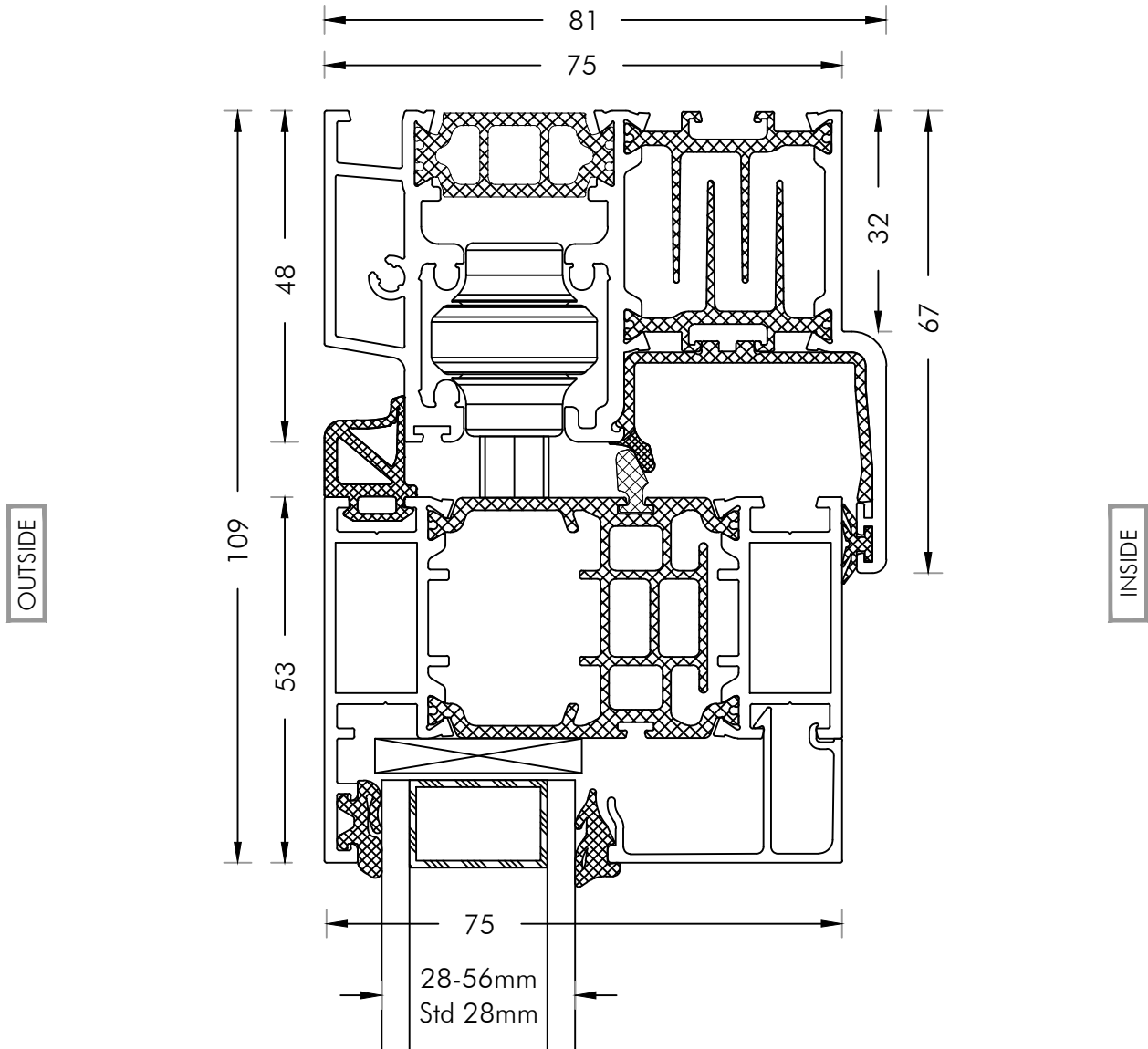
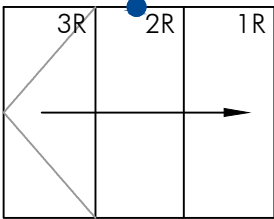

Description **Vertical Section - Connection**  
**Top Track - Panel / Open Out**

Detail No: **SF75-02**

System: **SF75**

**A**

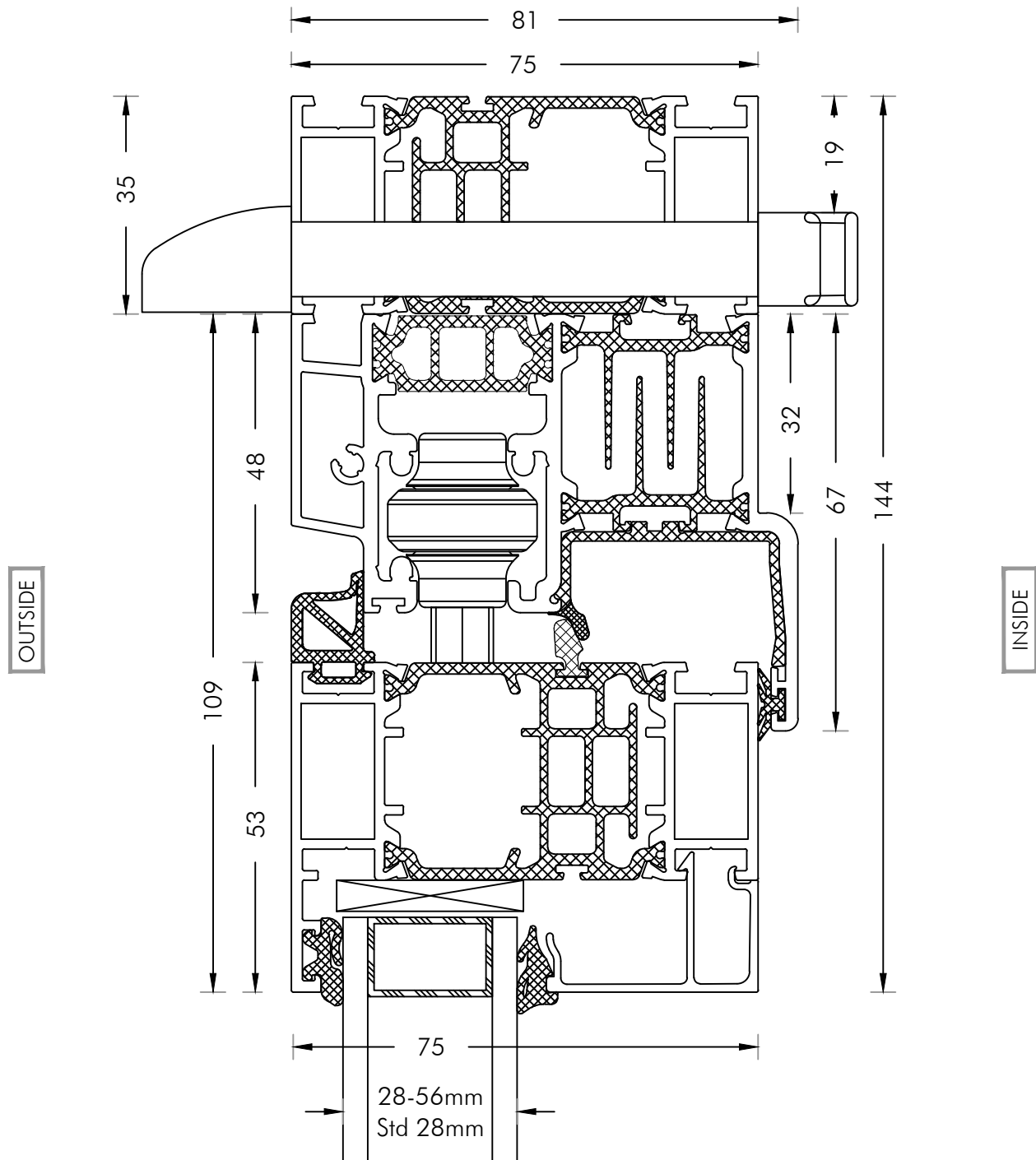
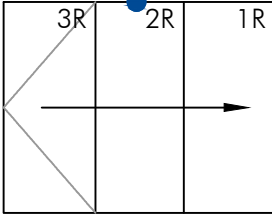

Description **Vertical Section - Connection**  
**Top Track With 40mm Extension And Trickle Vent - Panel /**  
**Open Out**

Detail No: **SF75-02TV**

System: **SF75**

**A**

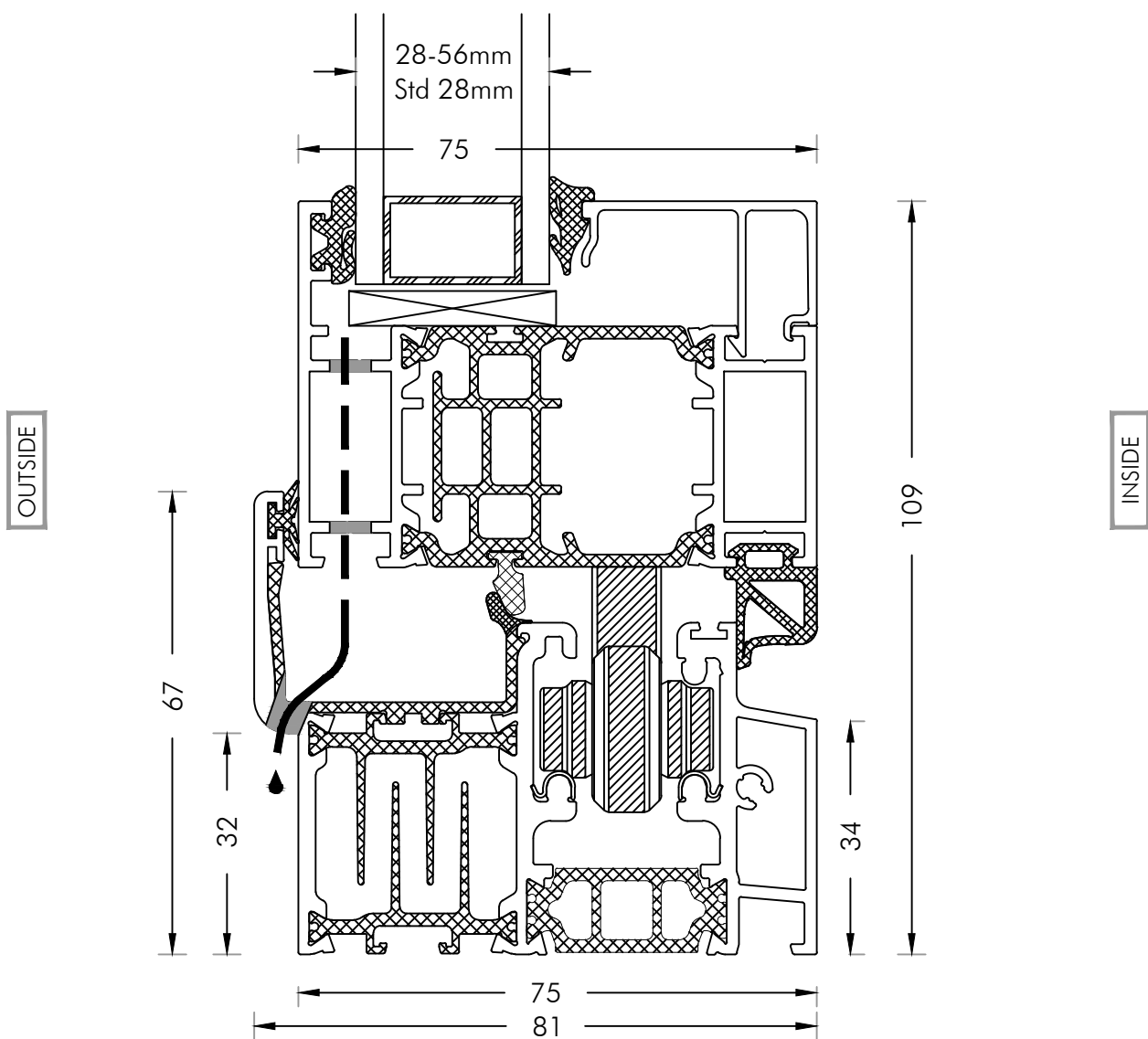
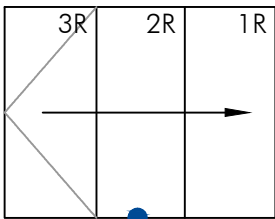

Description **Vertical Section - Connection**  
**Panel - Bottom Weathered Track / Open In**

Detail No: **SF75-03**

System: **SF75**

**A**

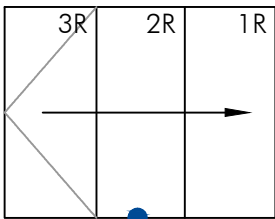

OUTSIDE

INSIDE

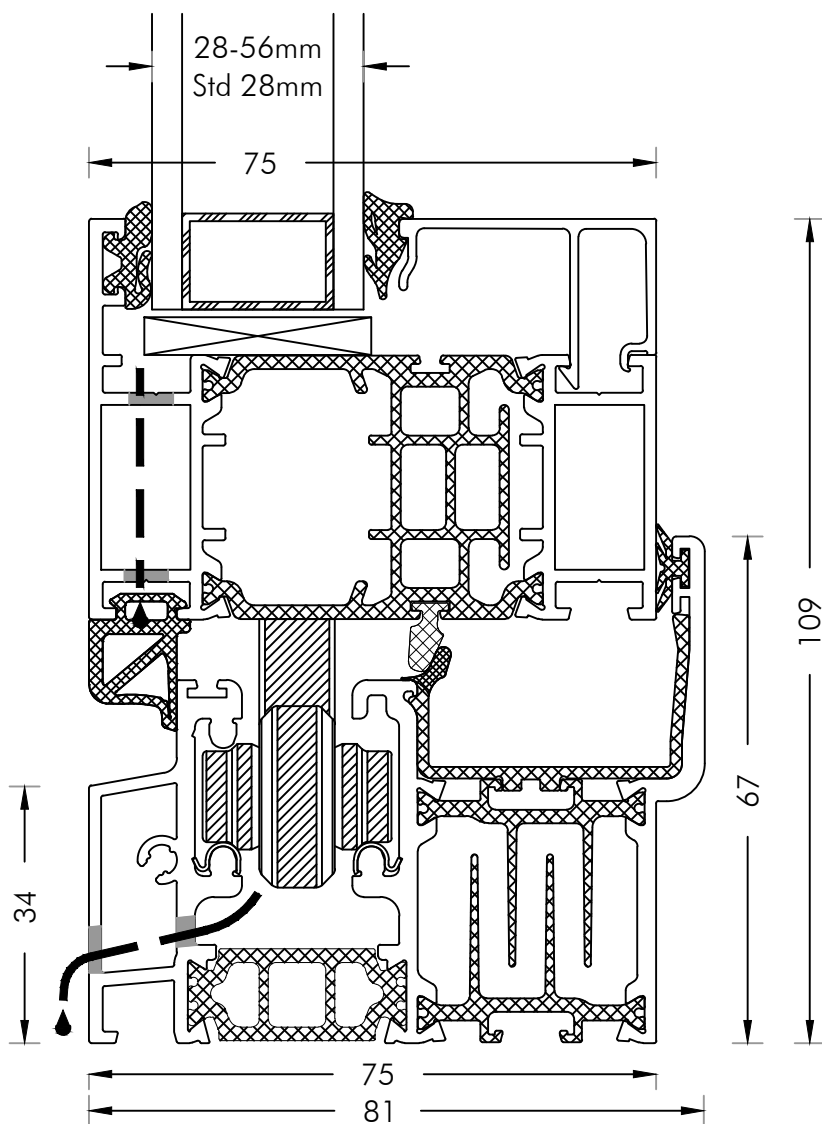

Description **Vertical Section - Connection**  
**Panel - Bottom Weathered Track / Open Out**

Detail No: **SF75-04**

System: **SF75**

**A**



OUTSIDE

INSIDE

Description **Blank**

Detail No: **SF75-05**

System: **SF75**

**A**



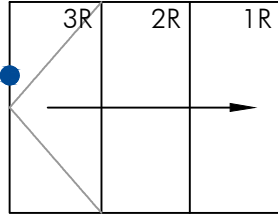

OUTSIDE

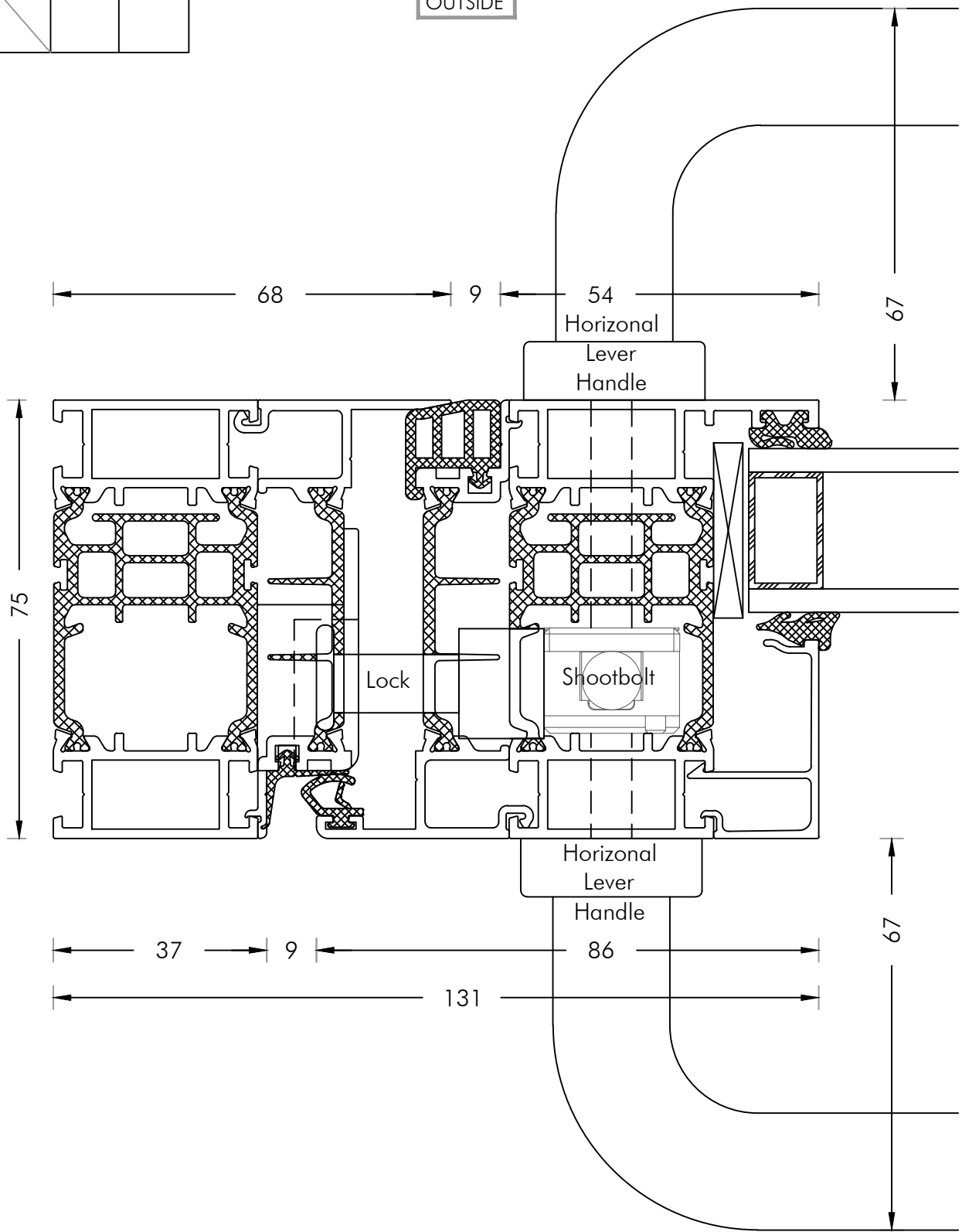

INSIDE

Description **Horizontal Section - Connection**  
**Closing Jamb - Panel 3R / Open In**

Detail No: **SF75-06**

System: **SF75**

**A**

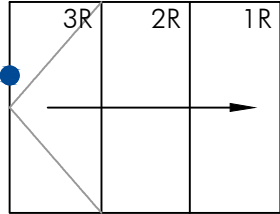

OUTSIDE

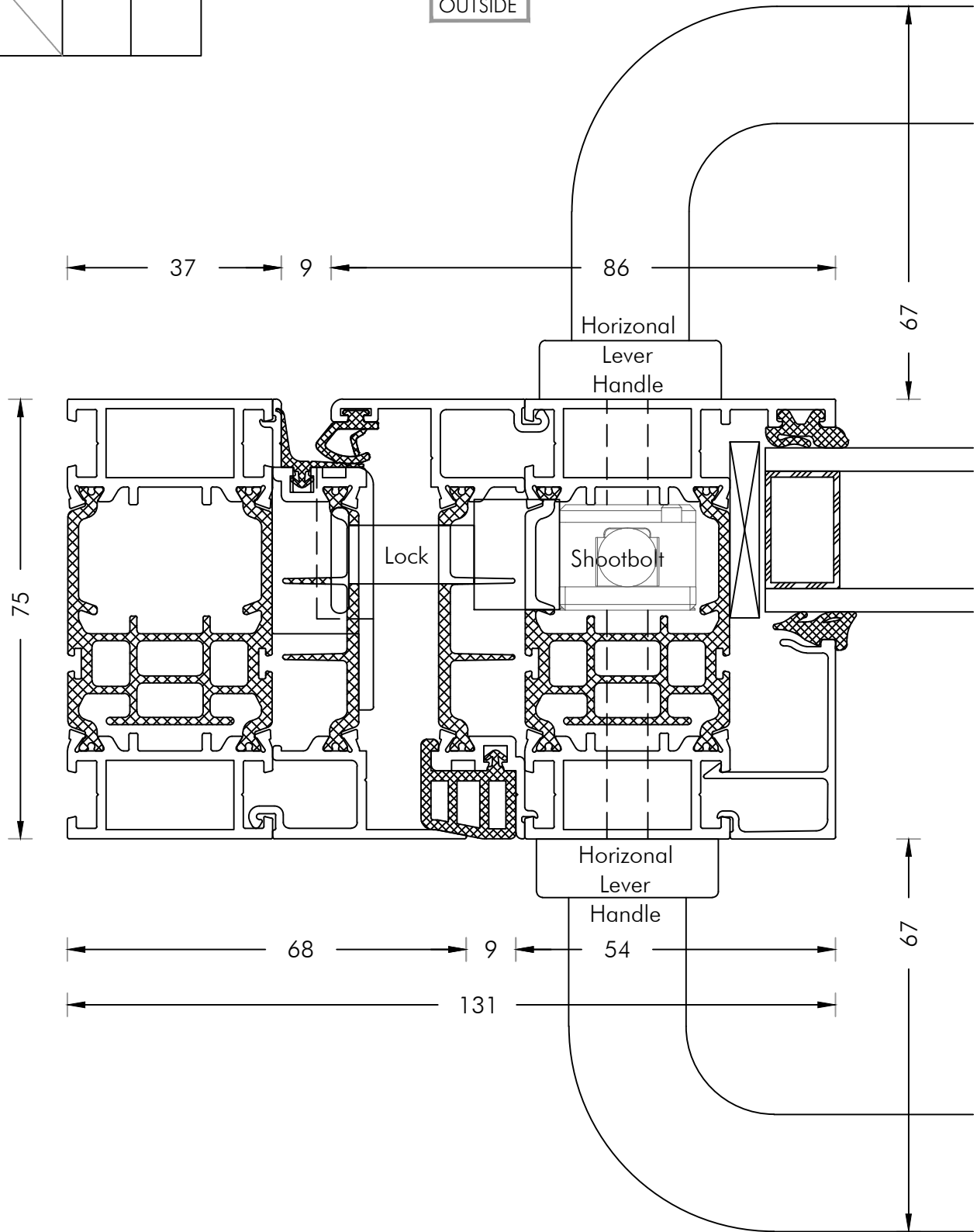

INSIDE

Description **Horizontal Section - Connection**  
**Closing Jamb - Panel 3R / Open Out**

Detail No: **SF75-07**

System: **SF75**

**A**

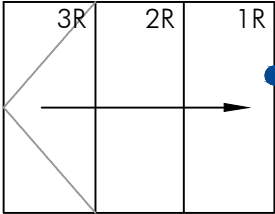

OUTSIDE

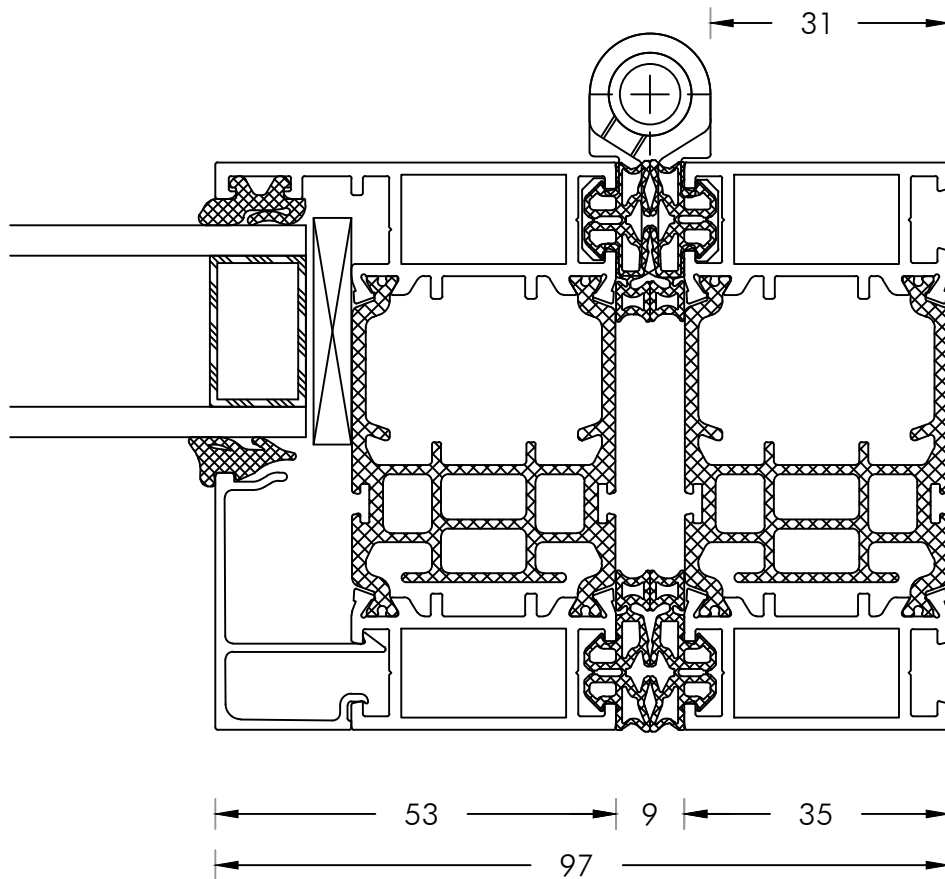

INSIDE

Description **Horizontal Section - Connection**  
**Panel 1R - Hinge Jamb / Open Out**

Detail No: **SF75-08**

System: **SF75**

**A**

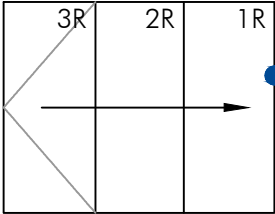

OUTSIDE

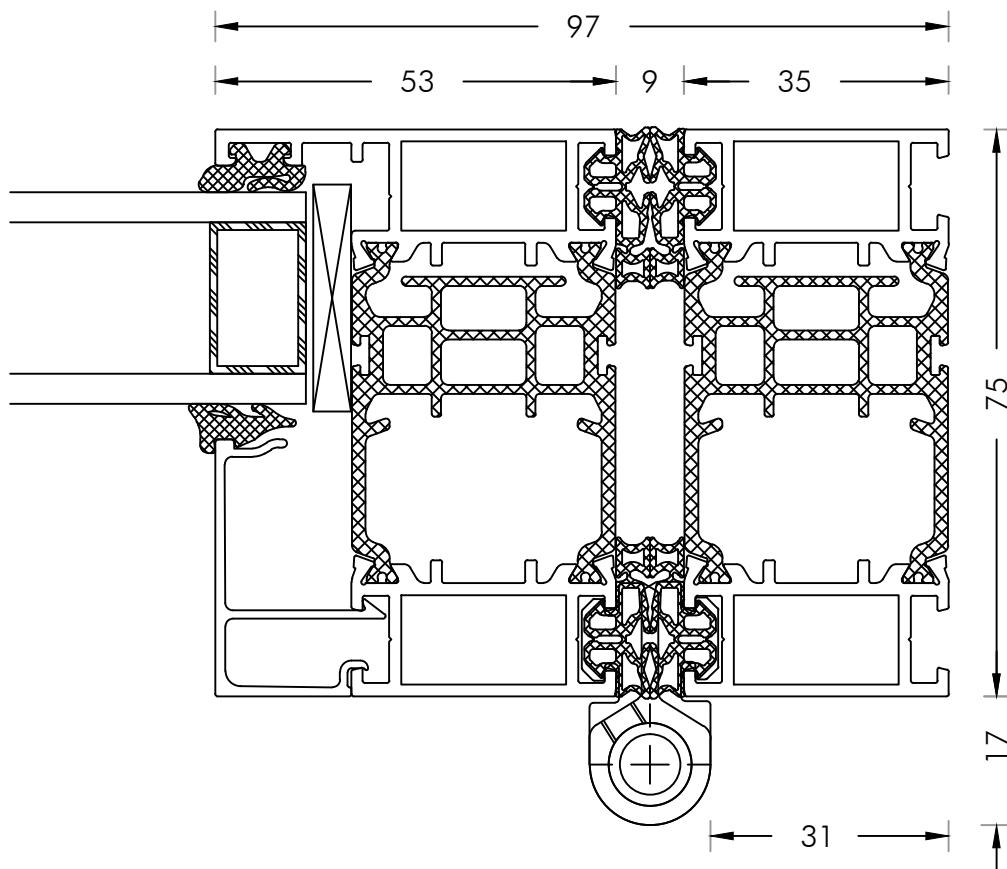

INSIDE

Description **Horizontal Section - Connection  
Panel 1R - Hinge Jamb / Open In**

Detail No: **SF75-09**

System: **SF75**

**A**

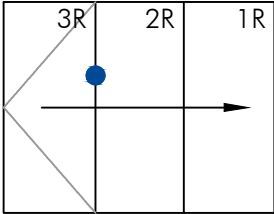

OUTSIDE

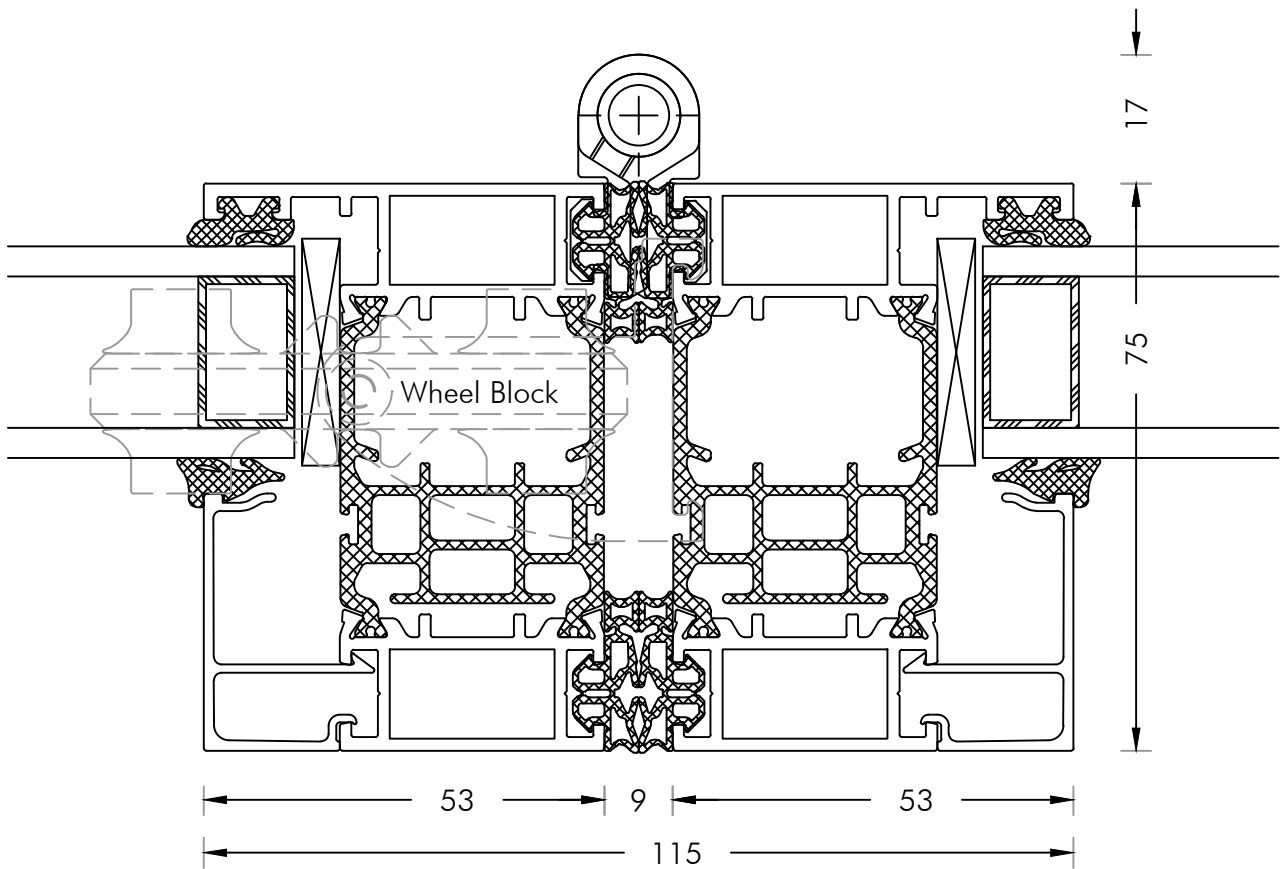

INSIDE

Description **Horizontal Section - Connection  
Panel 3R - Panel 2R / Open Out**

Detail No: **SF75-10**

System: **SF75**

**A**

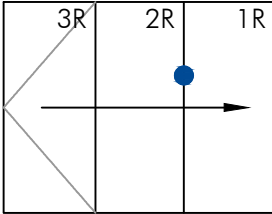

OUTSIDE

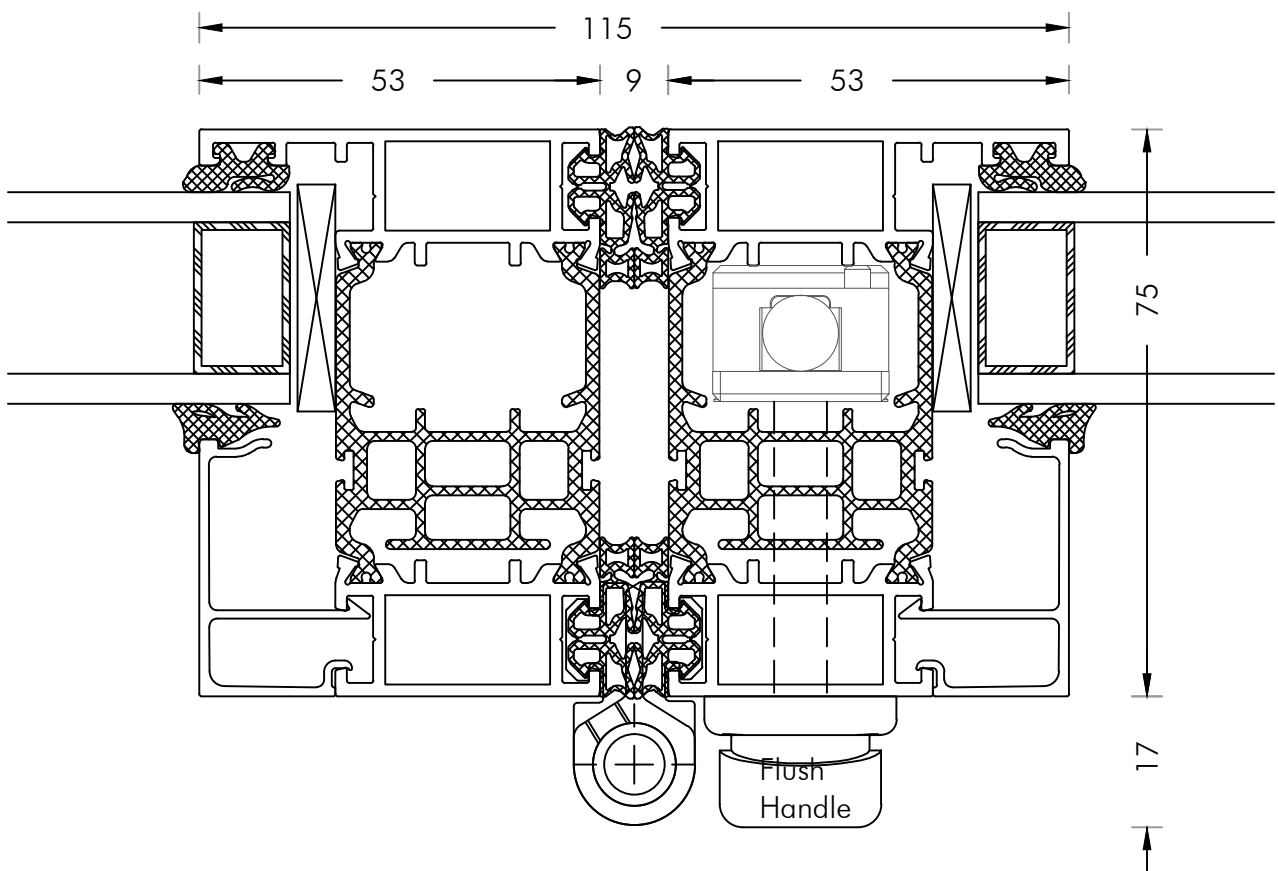

INSIDE

Description **Horizontal Section - Connection  
Panel 2R - Panel 1R / Open Out**

Detail No: **SF75-11**

System: **SF75**

**A**

OUTSIDE

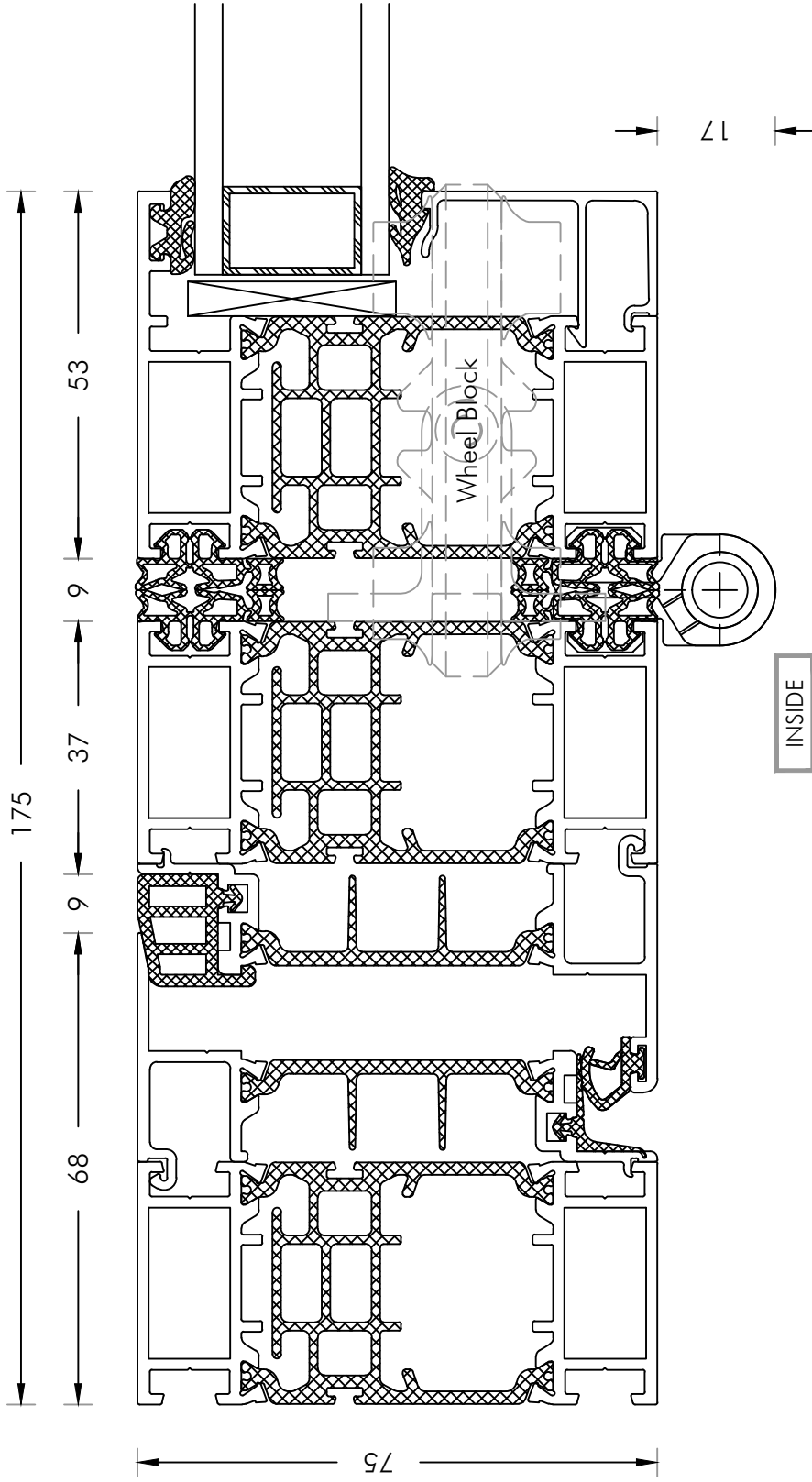
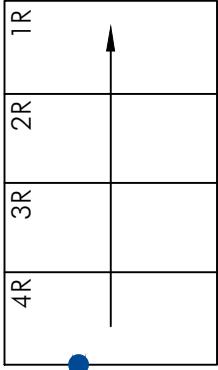

INSIDE

Description **Horizontal Section - Connection  
Closing Jamb - Sliding Post - Panel 4R / Open In**

Detail No: **SF75-12**

System: **SF75**

**A**

OUTSIDE

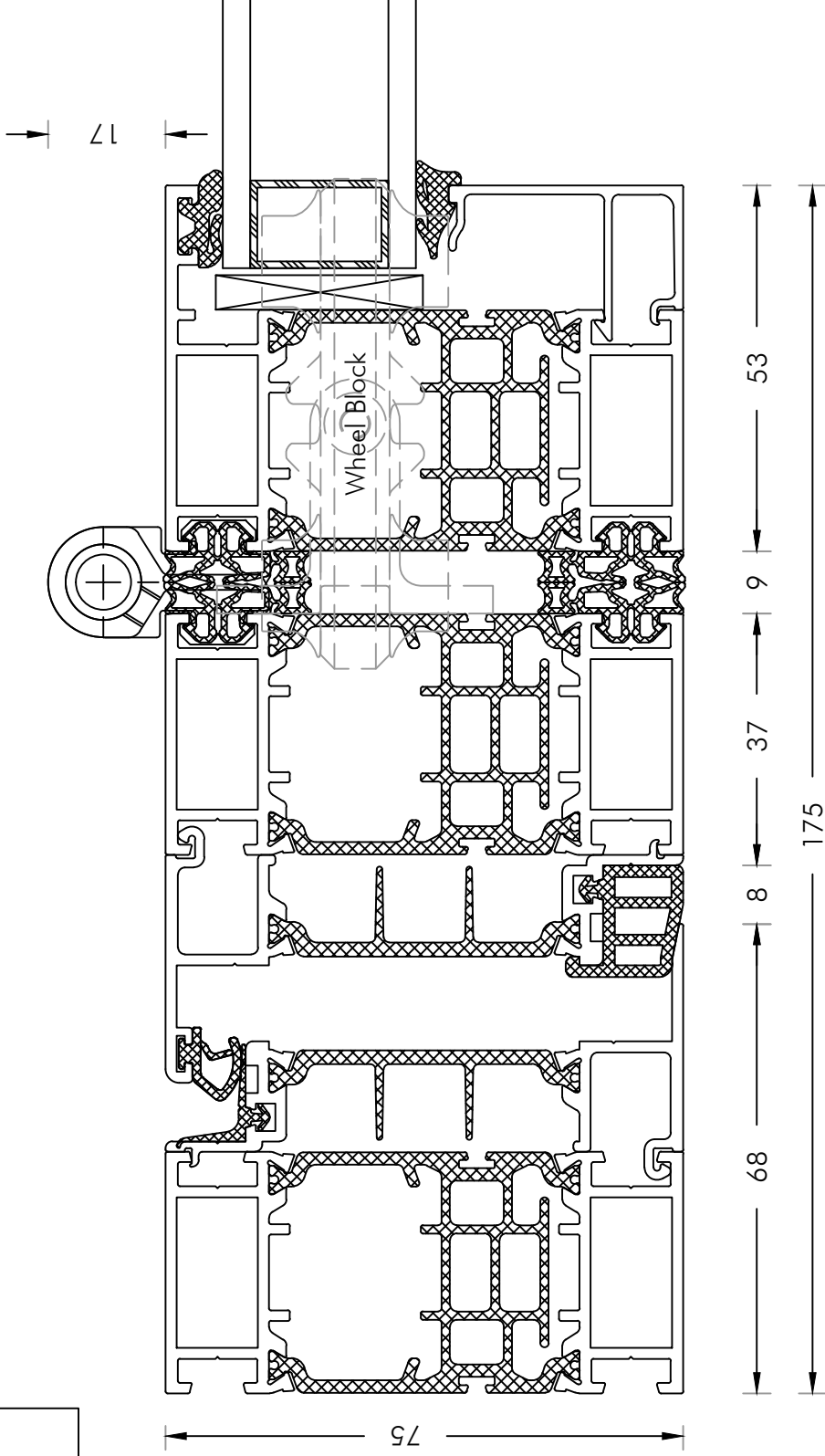
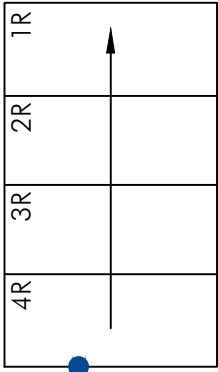

INSIDE

Description **Horizontal Section - Connection Closing Jamb - Sliding Post - Panel 4R / Open Out**

Detail No: **SF75-13**  
System: **SF75** **A**



OUTSIDE

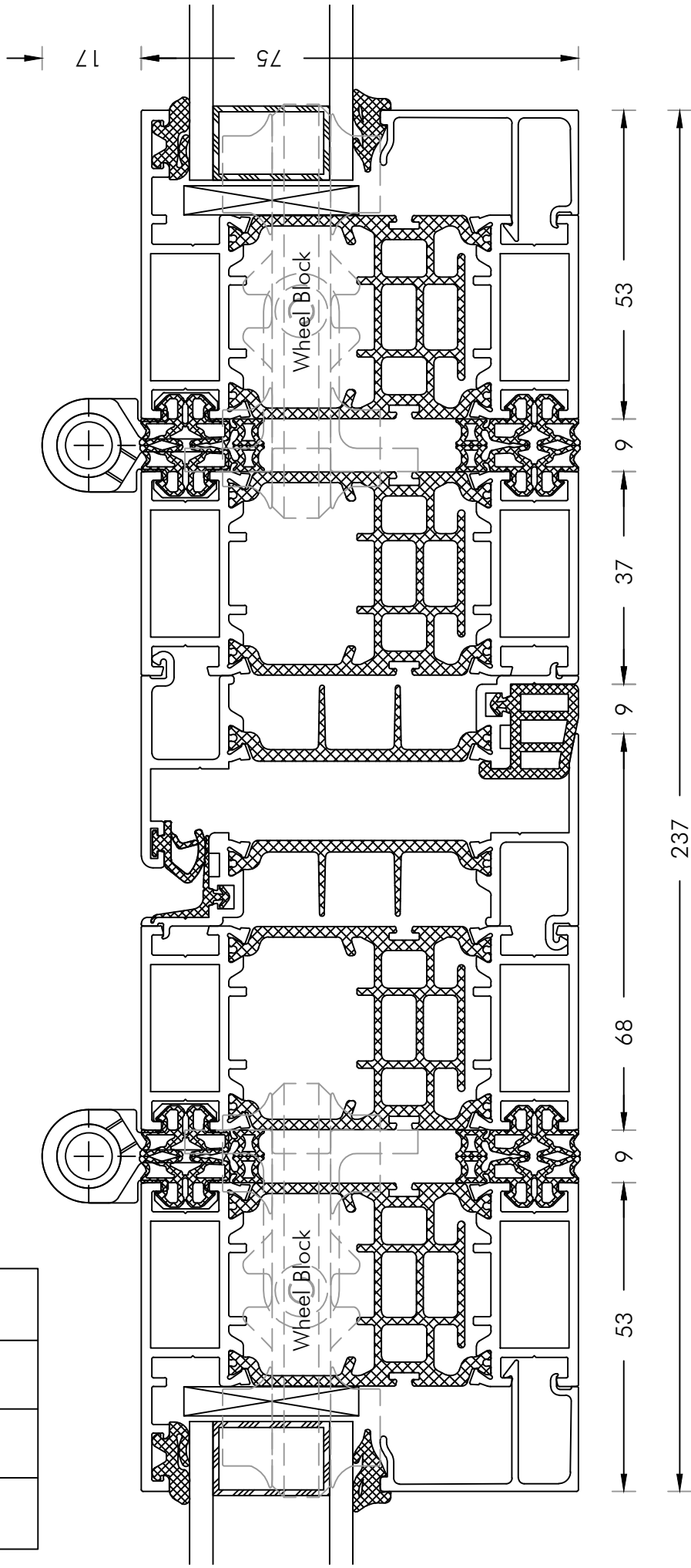
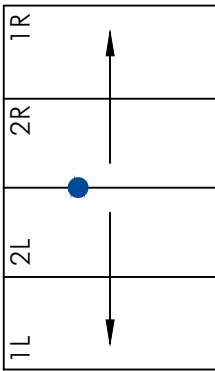

Description **Horizontal Section - Connection  
Panel 2L - Sliding Post - Sliding Post - Panel 2R/ Open Out**

Detail No: **SF75-14**  
System: **SF75** **A**

OUTSIDE

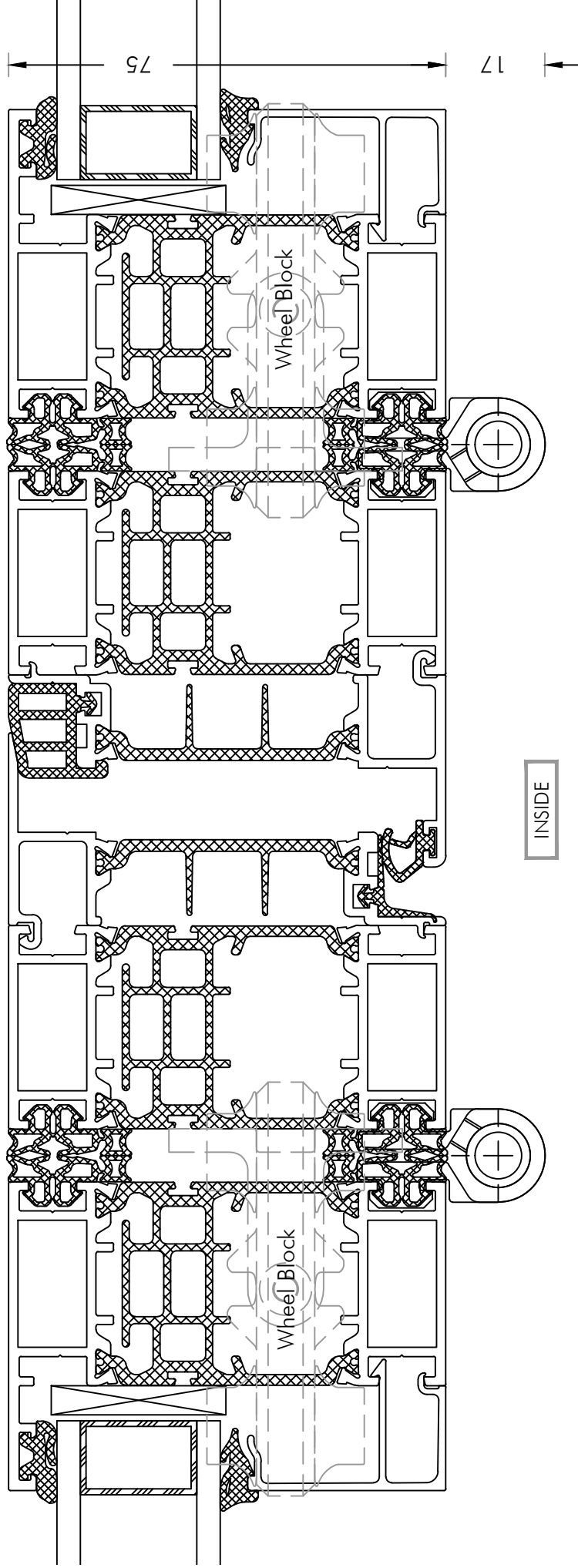
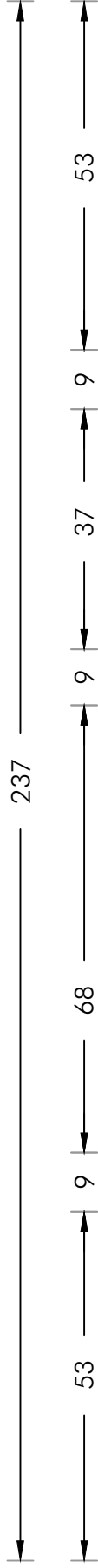
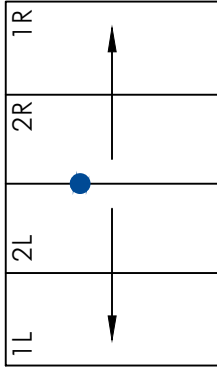

INSIDE

Description **Horizontal Section - Connection  
Panel 2L - Sliding Post - Sliding Post - Panel 2R/ Open In**

Detail No: **SF75-15**

System: **SF75**

**A**

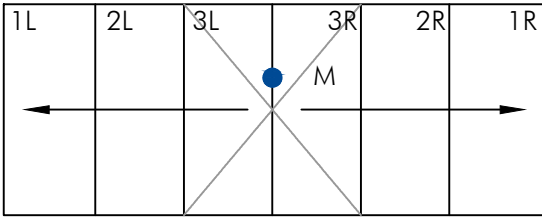

OUTSIDE

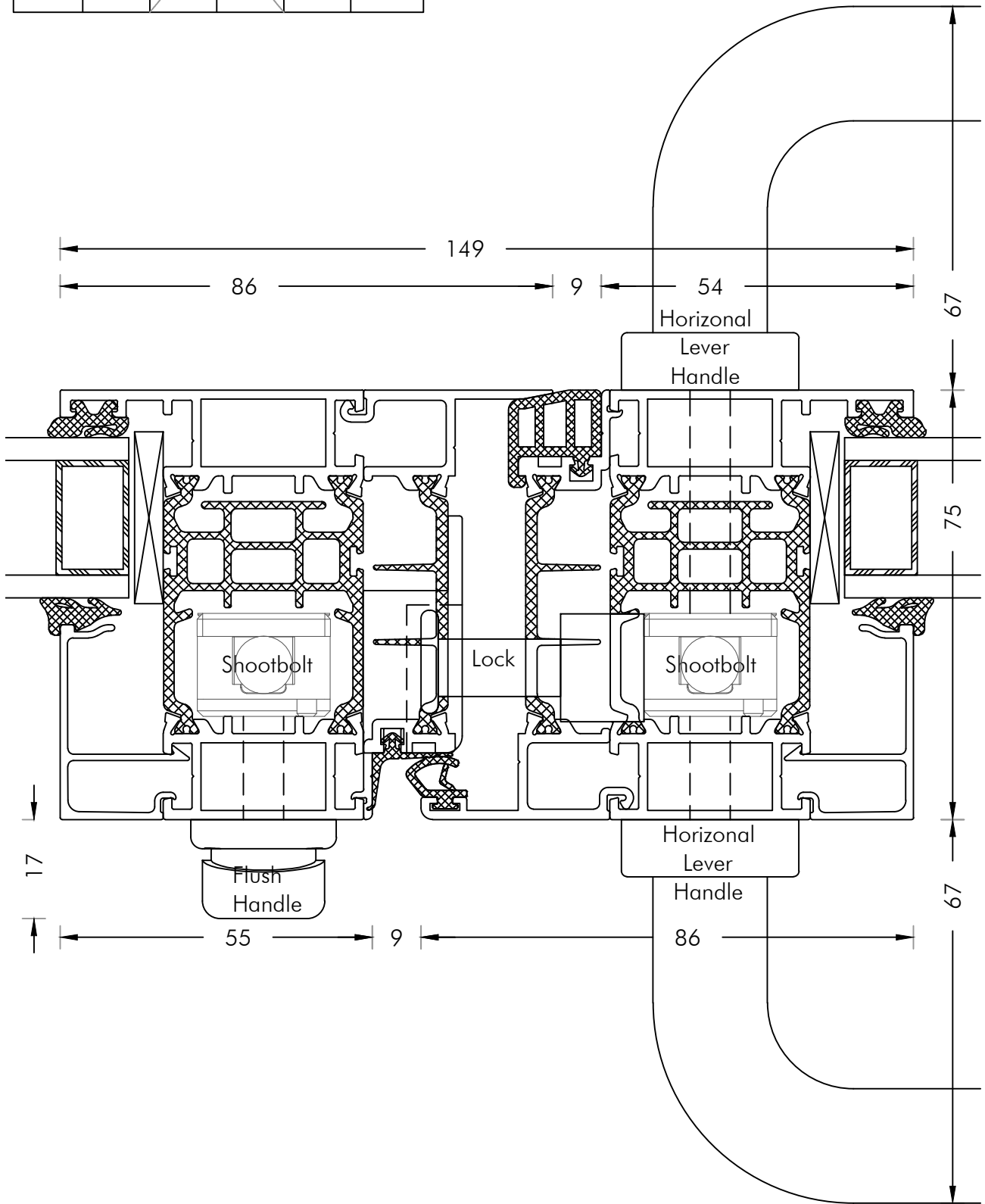

INSIDE

Description **Horizontal Section - Connection  
Panel 3L - Panel 3R / Open In  
(M = 1st Opening Panel 3R)**

Detail No: **SF75-16**

System: **SF75**

**A**

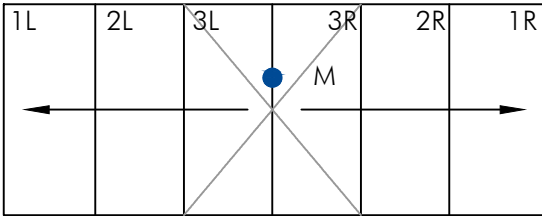

OUTSIDE

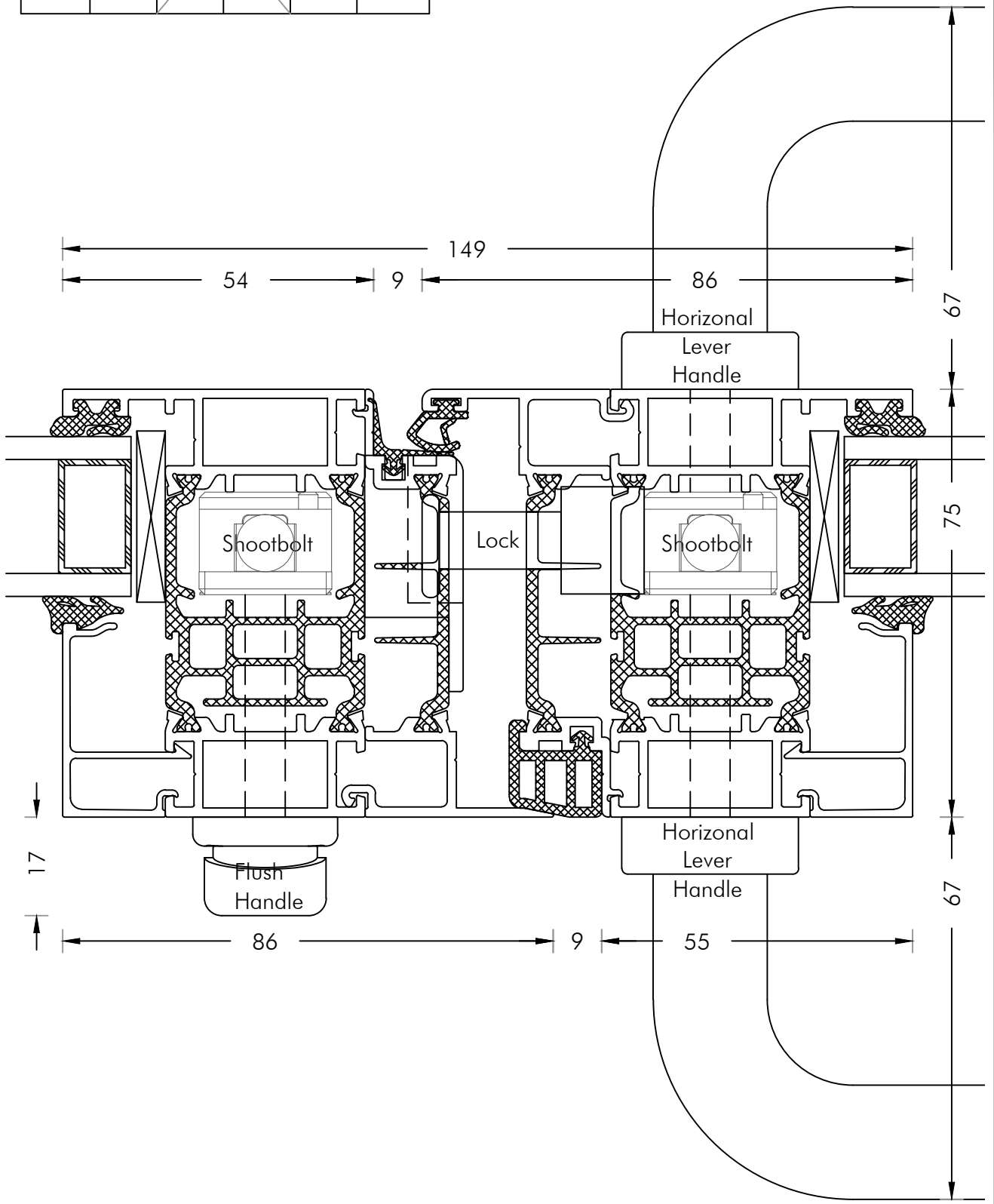

INSIDE

Description **Horizontal Section - Connection  
Panel 3L - Panel 3R / Open Out  
(M = 1st Opening Panel 3R)**

Detail No: **SF75-17**

System: **SF75**

**A**

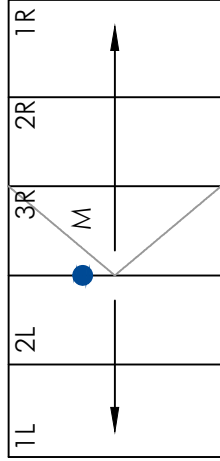

OUTSIDE

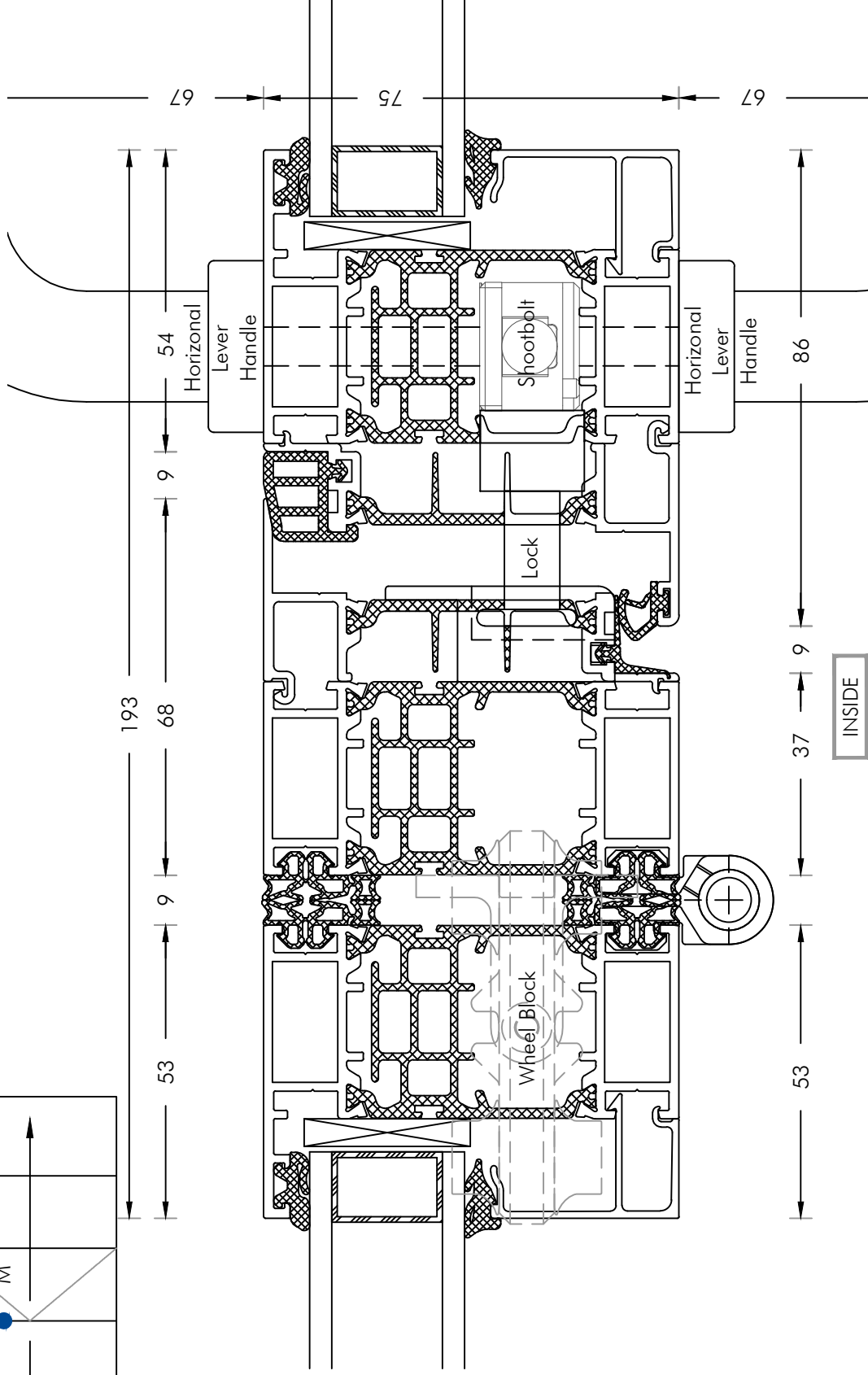

INSIDE

Description **Horizontal Section - Connection**  
**Panel 2L - Sliding Post - Panel 3R / Open In**  
**(M = 1st Opening Panel 3R)**

Detail No: **SF75-18**  
 System: **SF75** **A**

Scale 0.9

OUTSIDE

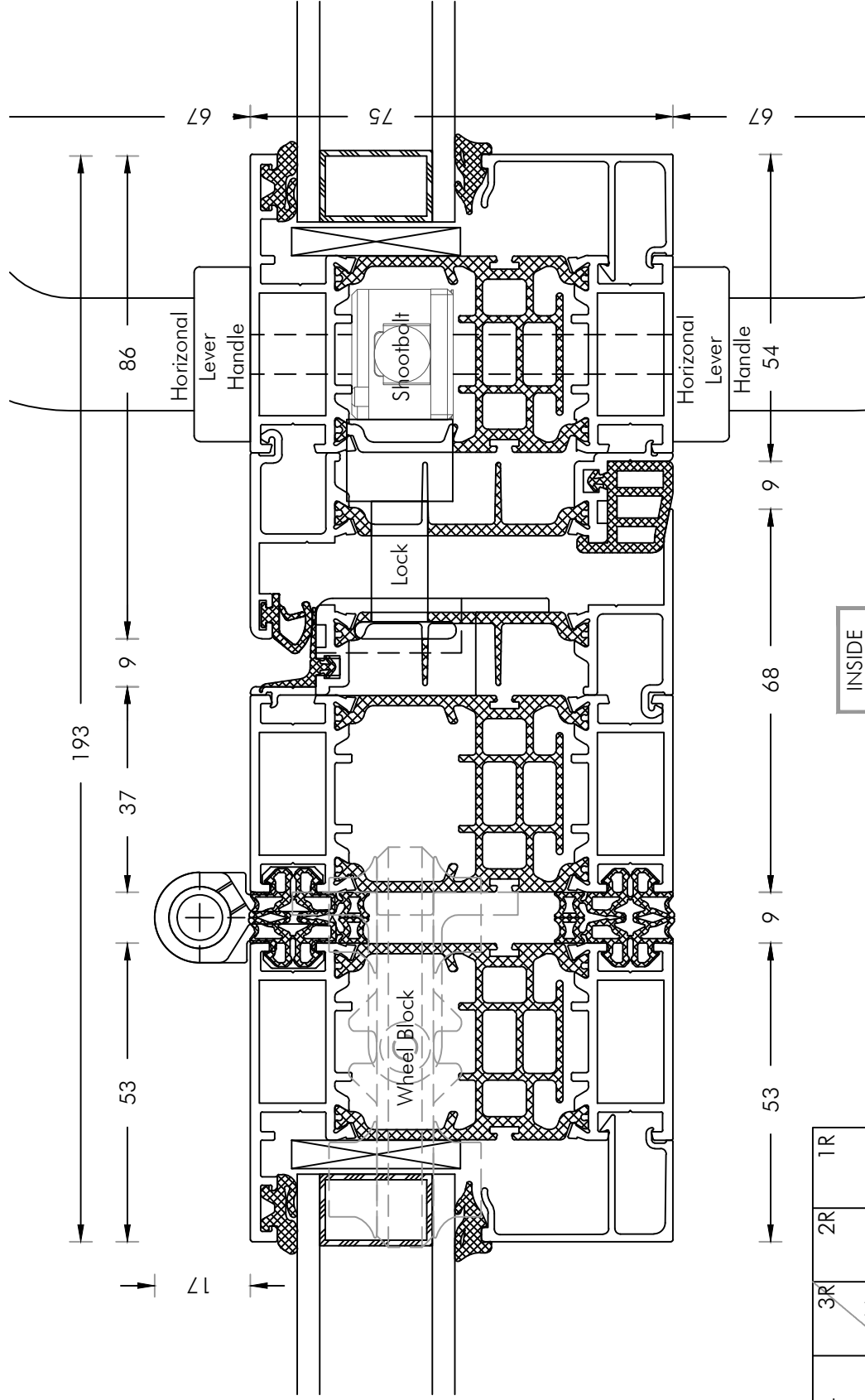

INSIDE

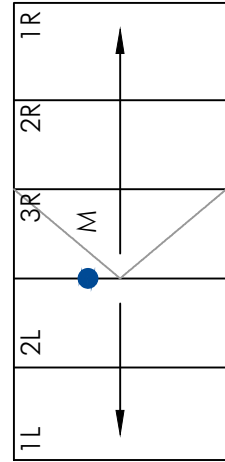

Description **Horizontal Section - Connection**  
**Panel 2L - Sliding Post - Panel 3R / Open Out**  
**(M = 1st Opening Panel 3R)**

Detail No: **SF75-19**

System: **SF75**

**A**

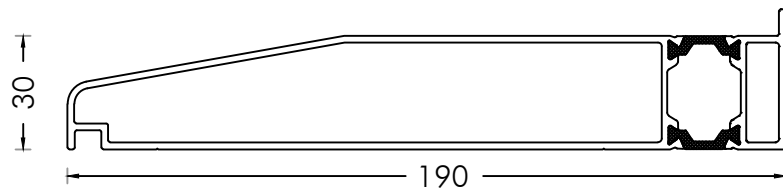
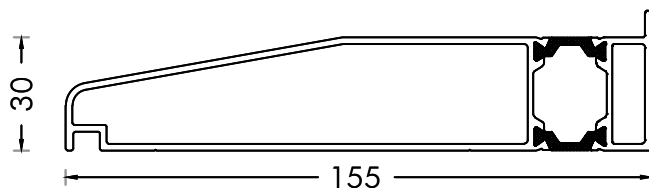
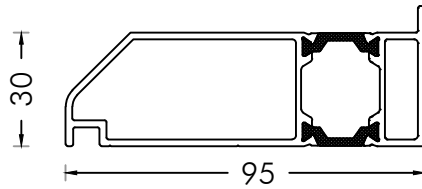

Description **Thermally Broken Aluminium Sills - Size Options**

Detail No: **SF75-20**

System: **SF75**

**A**

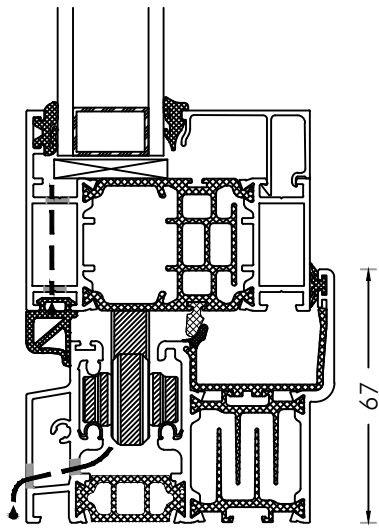

**Option 1, Open Out Weathered track**

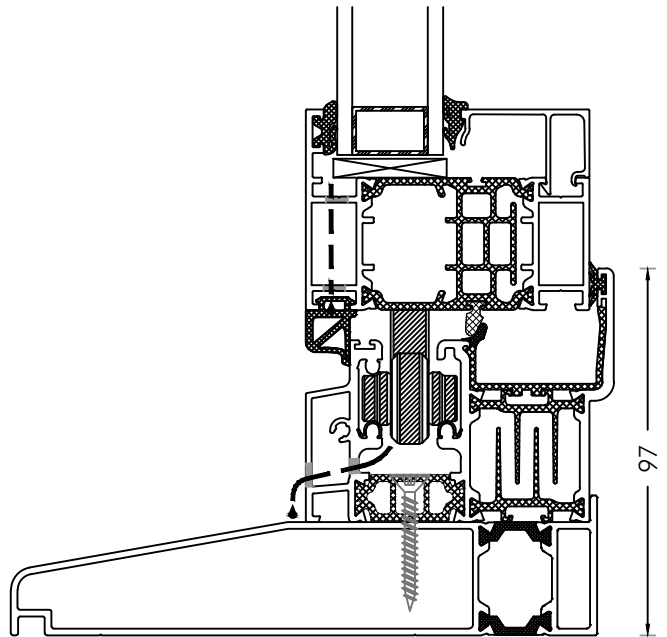

**Option 3, Open Out Weathered track on Thermally Broken Sill**

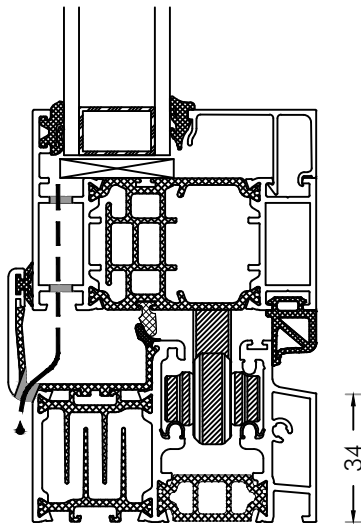

**Option 2, Open In Weathered track**

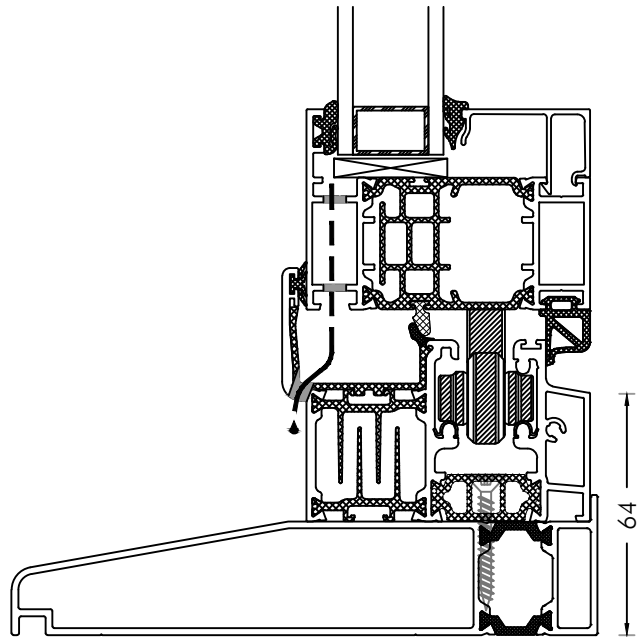

**Option 4, Open In Weathered track on Thermally Broken Sill**

Description **Vertical Section  
Threshold Options - Weathered Track**

Detail No: **SF75-21**

System: **SF75**

**A**





Description **Blank**

Detail No: **SF75-22**

System: **SF75**

**A**

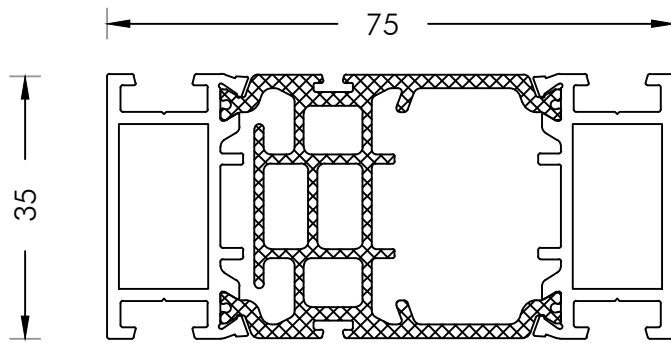

**35mm Frame Extension**

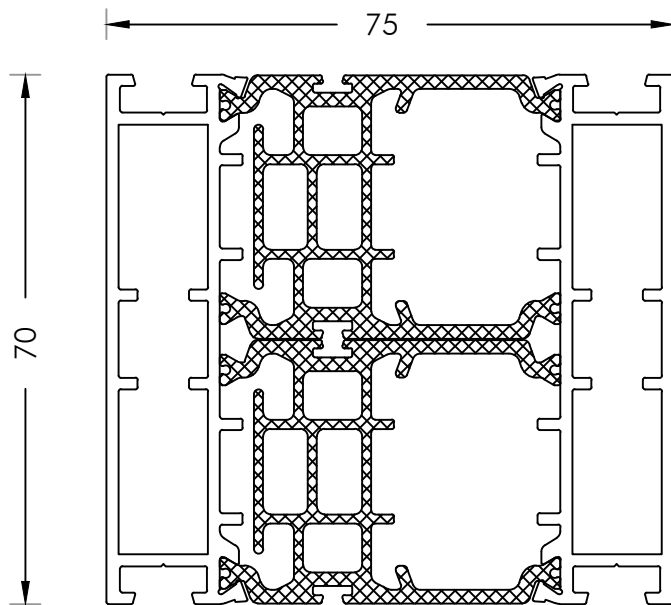

**70mm Frame Extension**

Description **Horizontal Section  
Additional Profiles**

Detail No: **SF75-23**

System: **SF75**

**A**

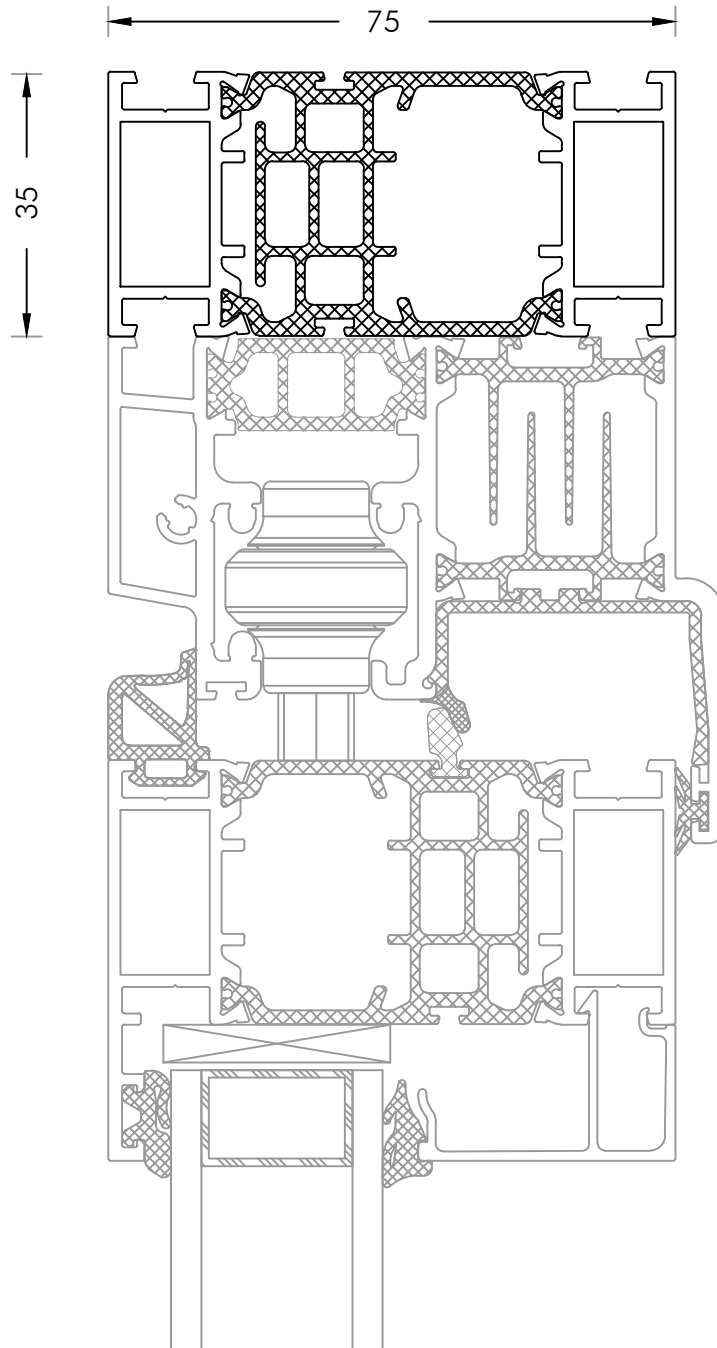

**35mm Add-on**

Description **Horizontal Section  
Additional Profiles**

Detail No: **SF75-24**

System: **SF75**

**A**

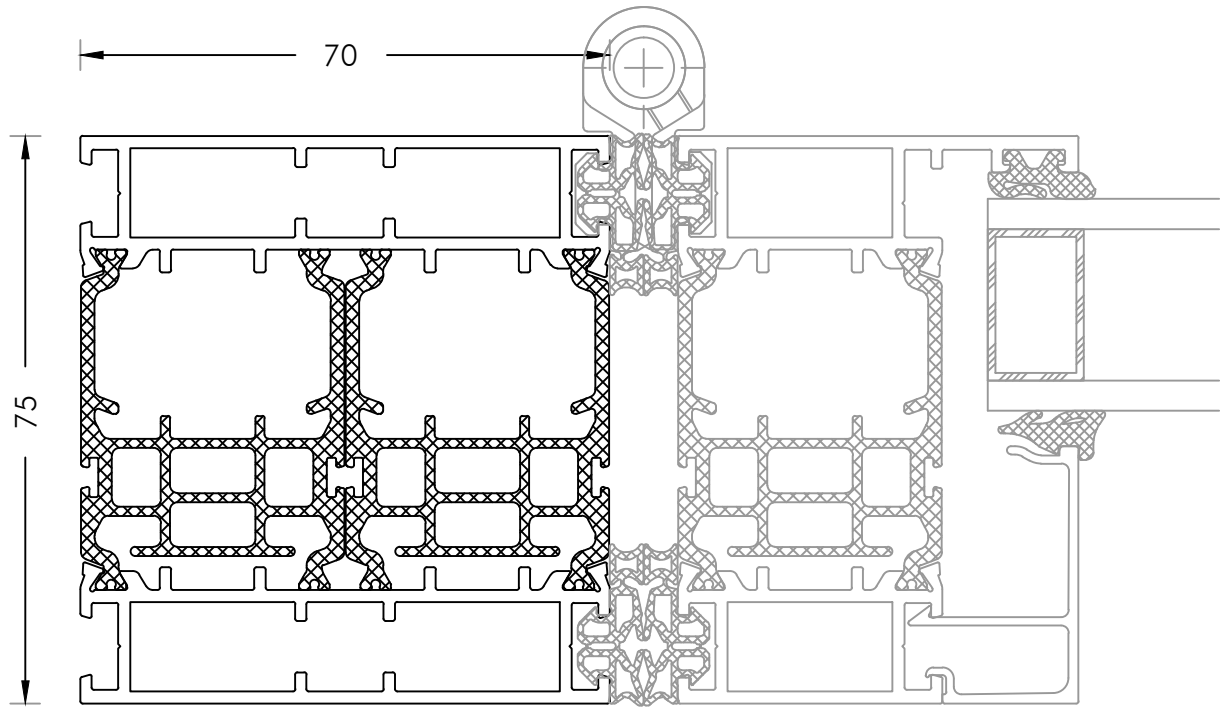

**70mm Jamb**

Description **Horizontal Section**  
**Additional Profiles**

Detail No: **SF75-25**

System: **SF75**

**A**

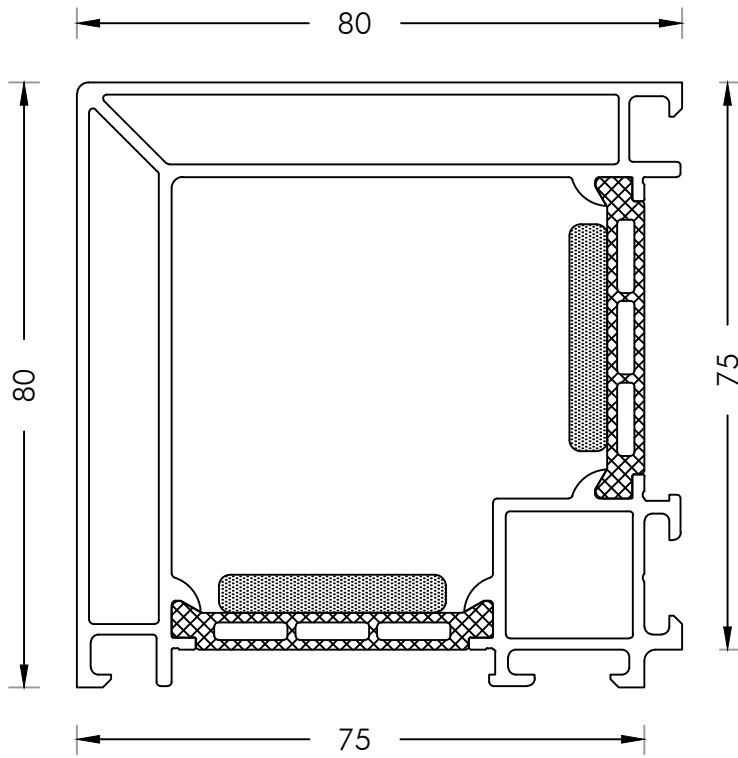

**90° Post**

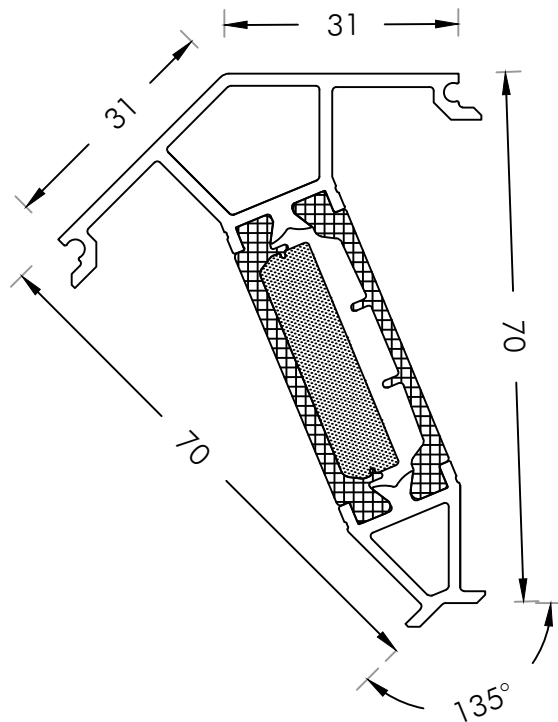

**135° Post**

Description **Horizontal Section**  
**Vertical Post Options**

Detail No: **SF75-26**

System: **SF75**

**A**

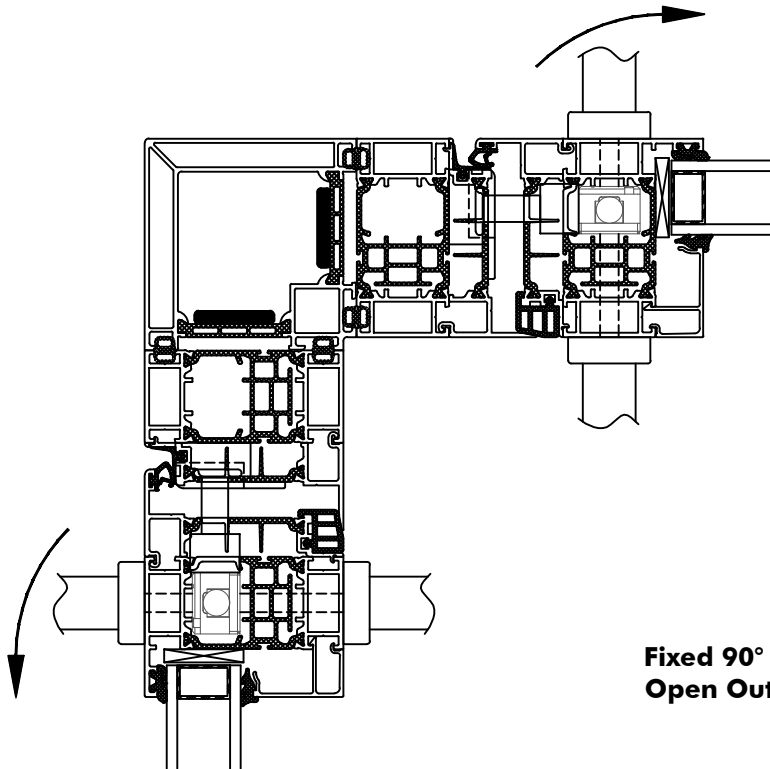

**Fixed 90° Post with  
Open Out Panels**

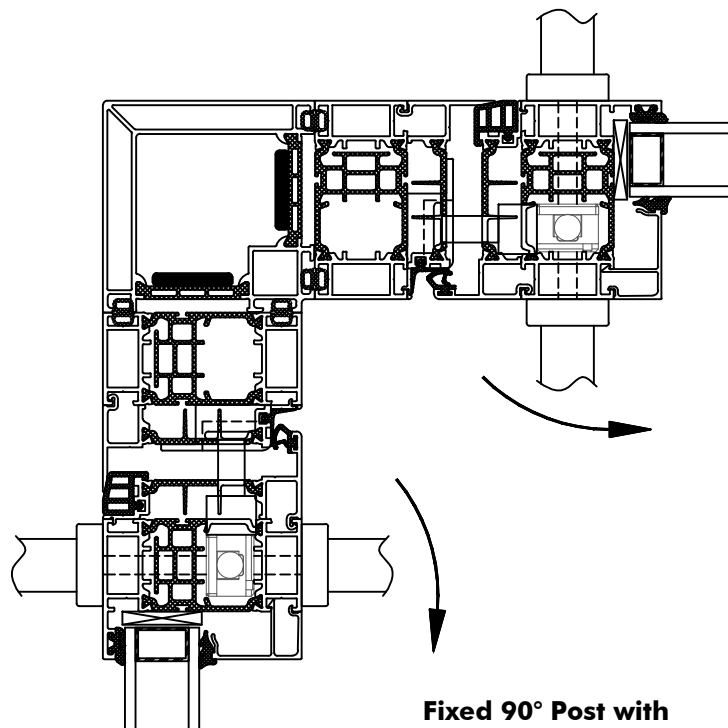

**Fixed 90° Post with  
Open In Panels**

Description **Horizontal Section  
Typical Fixed 90° Post Examples**

Detail No: **SF75-27**

System: **SF75**

**A**

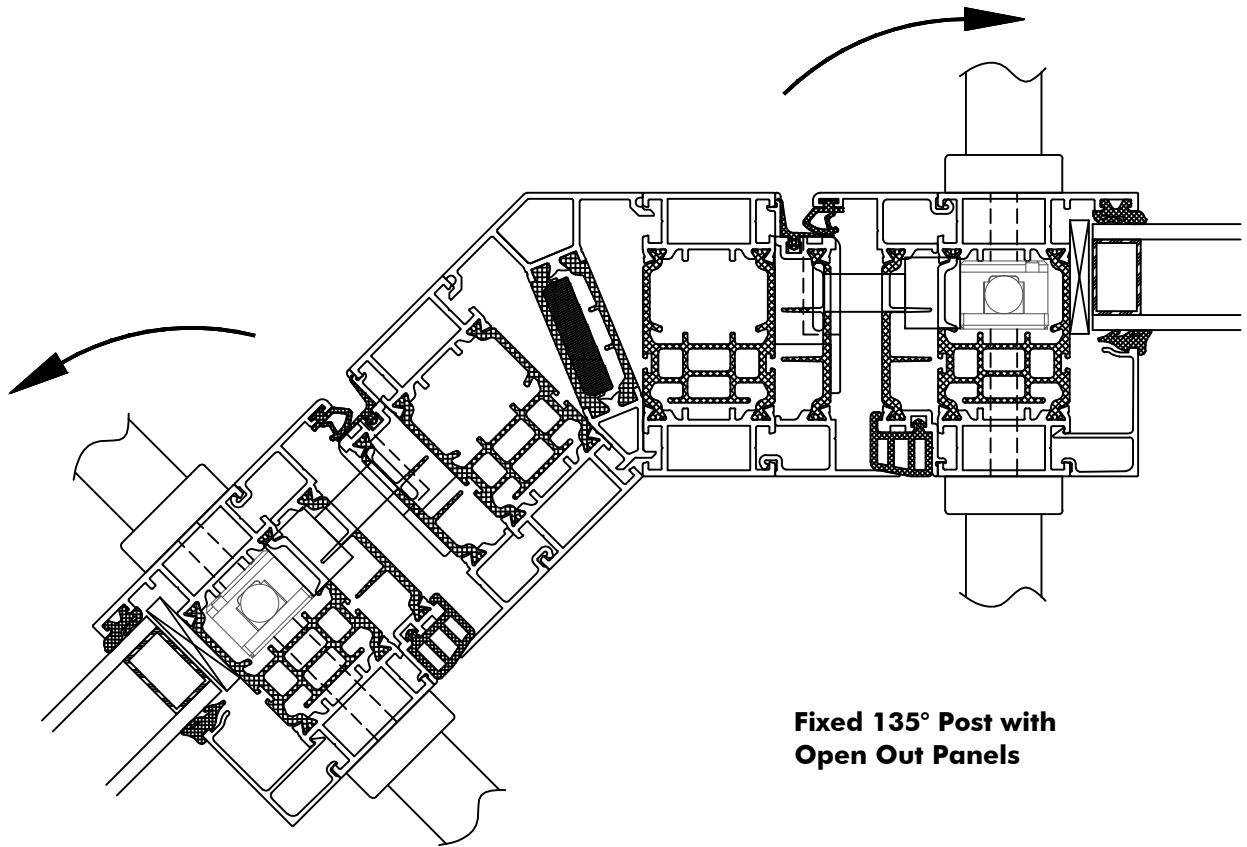

**Fixed 135° Post with  
Open Out Panels**

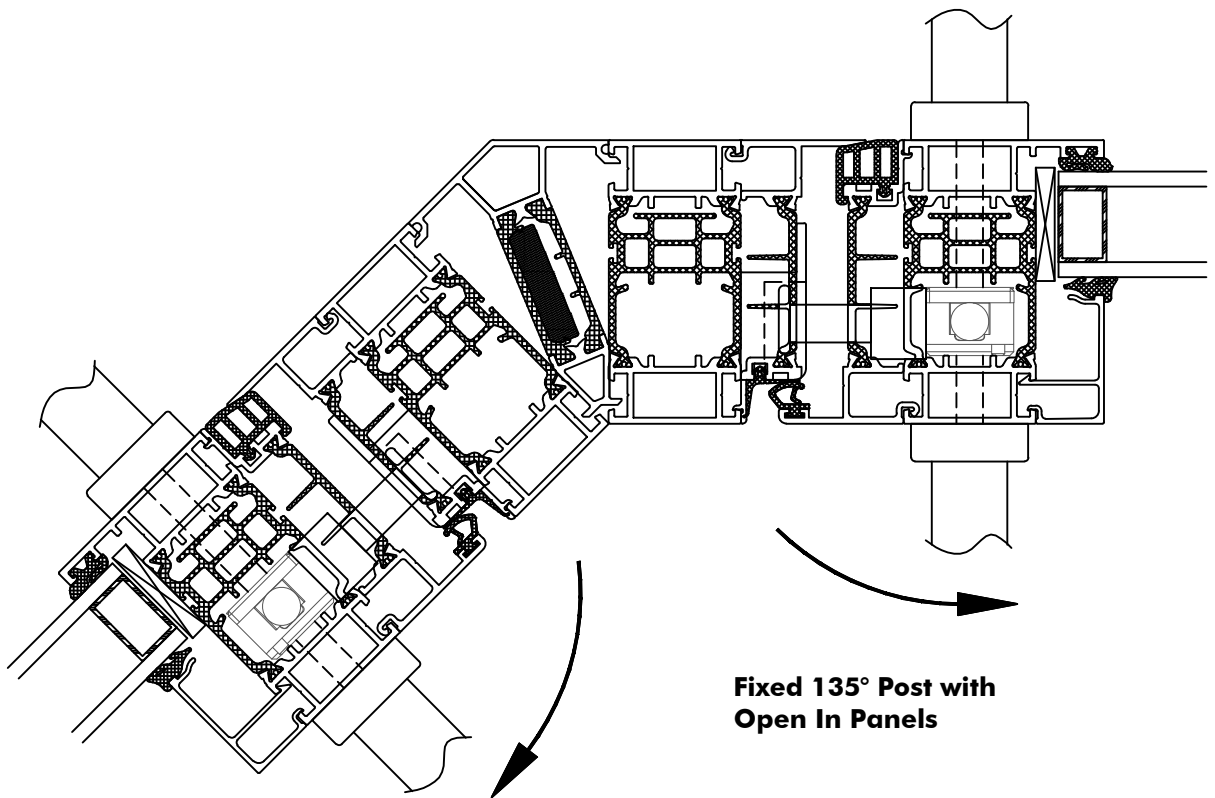

**Fixed 135° Post with  
Open In Panels**

Description **Horizontal Section  
Typical 135° Fixed Post Examples**

Detail No: **SF75-28**

System: **SF75**

**A**

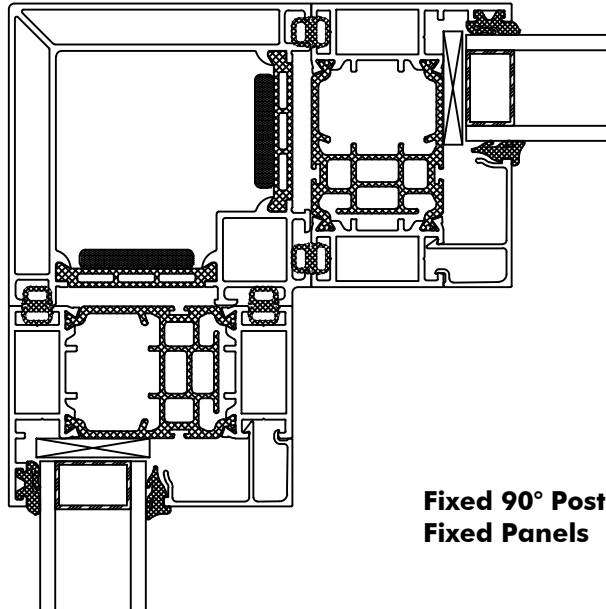

**Fixed 90° Post with  
Fixed Panels**

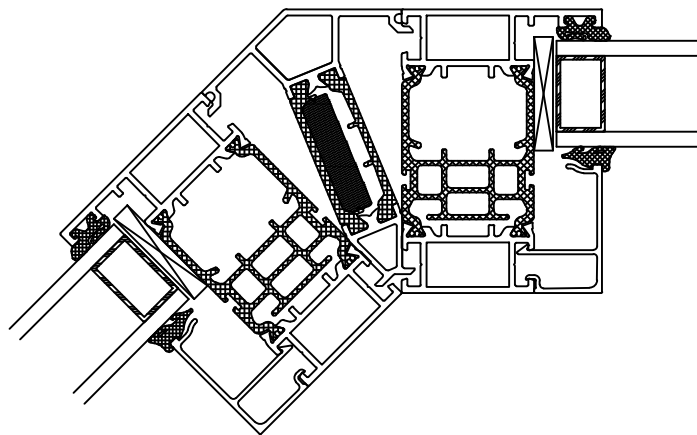

**Fixed 135° Post with  
Fixed Panels**

Description **Horizontal Section  
Typical Fixed Post Examples**

Detail No: **SF75-29**

System: **SF75**

**A**



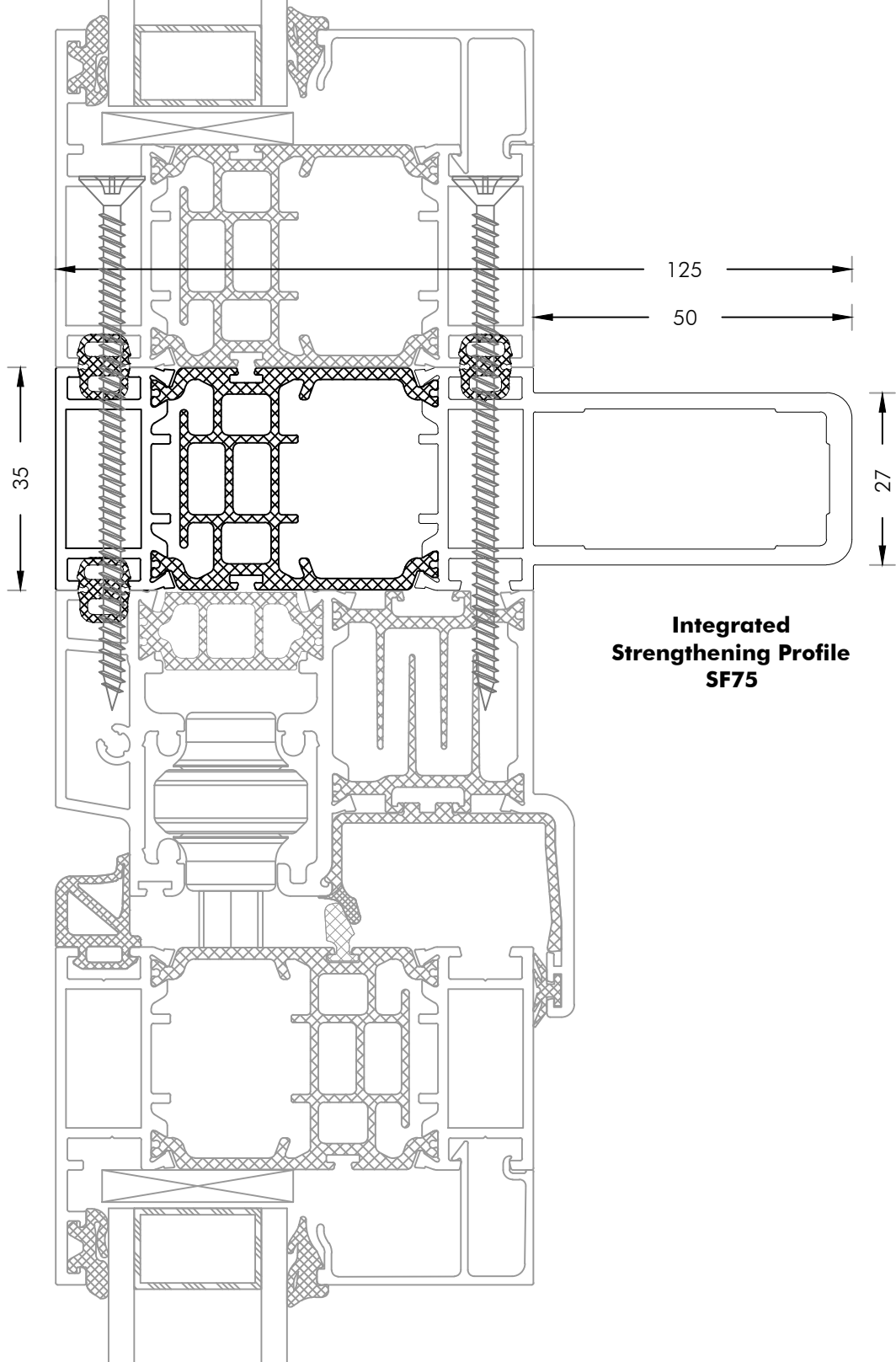

**Integrated  
Strengthening Profile  
SF75**

**NB:-**

**Required to be used on Door sets with Overlights when System Width Exceeds 3 M \* in Exposed Locations or when System Width Exceeds 4 M \* in Unexposed Locations**

**\* This dimension may vary according to the depth of the Overlights**

Description **Vertical Section  
Overlight - Strengthening Profile - Top Track**

Detail No: **SF75-32**

System: **SF75**

**A**

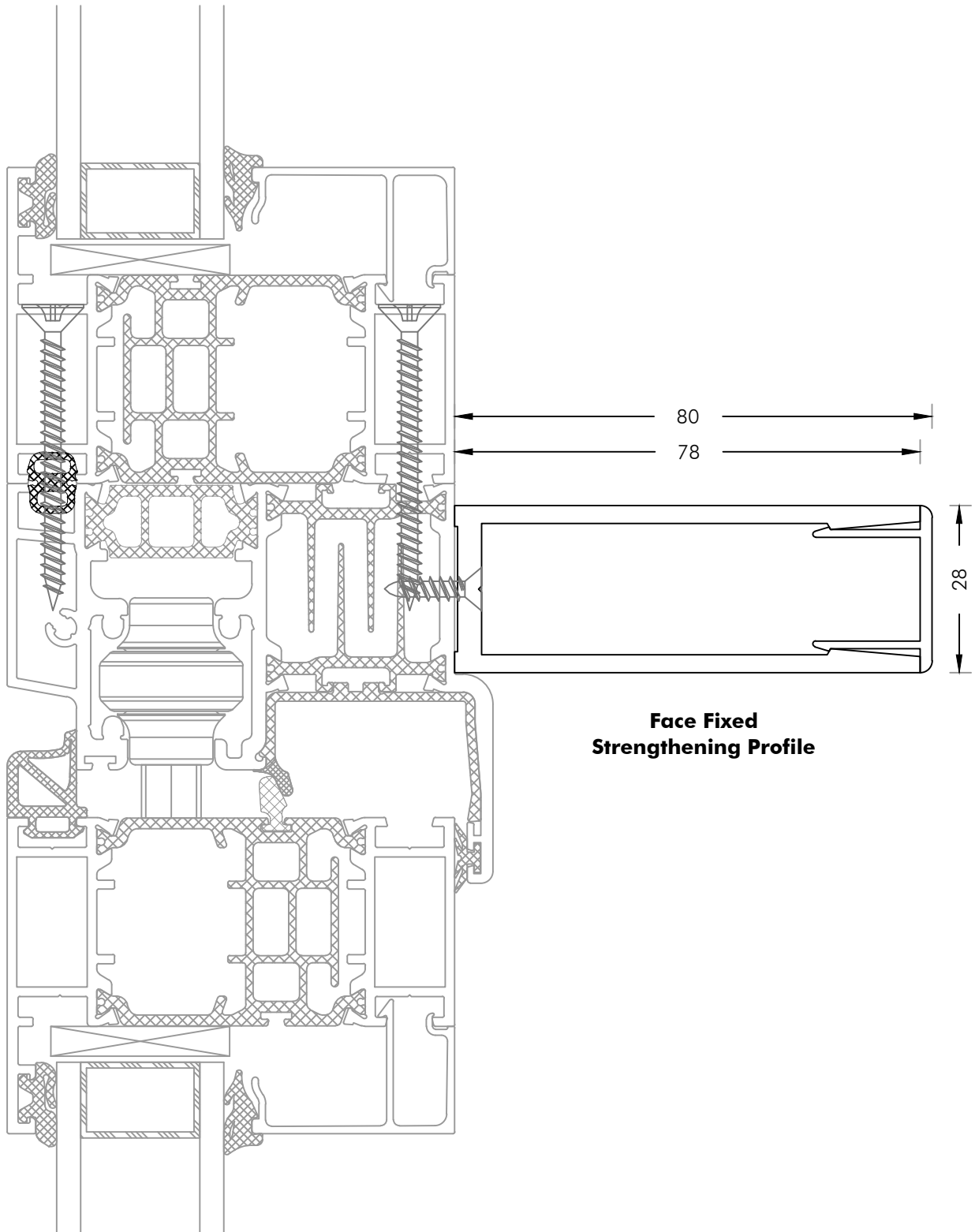

**NB:-**

**Required to be used on Door sets with Overlights In Unexposed Locations when System Width Exceeds 2.5, upto a Maximum of 4 M \***

**\* This dimension may vary according to the depth of the Overlights**

Description **Vertical Section  
Overlight - Top Track with Additional Face Fixed  
Strengthening Profile**

Detail No: **SF75-33**

System: **SF75**

**A**