

## SQUIF SINGLE FANS

HIGH PRESSURE AND VOLUME CENTRIFUGAL EXTRACT FAN WITH MOTOR OUT OF AIRSTREAM, IDEAL FOR KITCHEN CANOPY APPLICATIONS.



## BENEFITS

### QUIET OPERATION

One of the quietest solutions for motor unit out of airstream applications. The units shall be suitable for operation in airstream temperatures up to 90°C.

### CLEANER OPERATION

'Out of air stream' motors are ideal for dirty extract and greasy environments. Cleaner motor operation extends motor life.

### IDEAL FOR HIGH RESISTANCES

Backward curved centrifugal impellers provide high pressure development suitable for ducted systems and kitchen canopy with extreme filtration.

### FLEXIBLE SOLUTION

Can be mounted internally, externally, vertically or horizontally.

### CONTROL-ABILITY AS STANDARD

All 3 phase units have the flexibility to be speed controlled utilising Nuaire Ecosmart controls or frequency inverters.

### INSPECTION PANELS

Allow for easy access.

### FAN TO SUIT ALL APPLICATIONS

2-speed motors available for day-to-day extract.

### EASY MAINTENANCE

'Out of air stream' allows for quick and easy access and lower maintenance costs.

### ECOSMART COMPATIBILITY

Three phase units can be supplied with Ecosmart controls, providing a simple to install, easy to commission, energy efficient solution. Also facilitates the interconnection of supply AHU.

### WARRANTY

Squif has a 3 year warranty.

Ecosmart Squif has a 5 year warranty.

## SQUIF ANCILLARIES

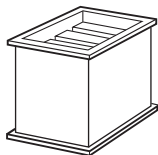

Splitter Attenuator.

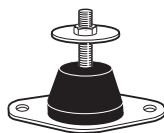

AV Mounts.

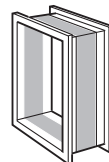

Flexible Connector.

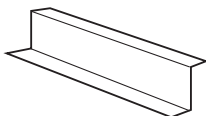

Feet built in.

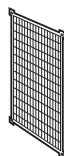

Guard for square units.

## CONTROLS

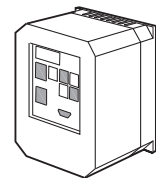

Inverter Speed Control. (Three phase).

PERFORMANCE - SQUIF SINGLE FANS

Squif - 4 pole

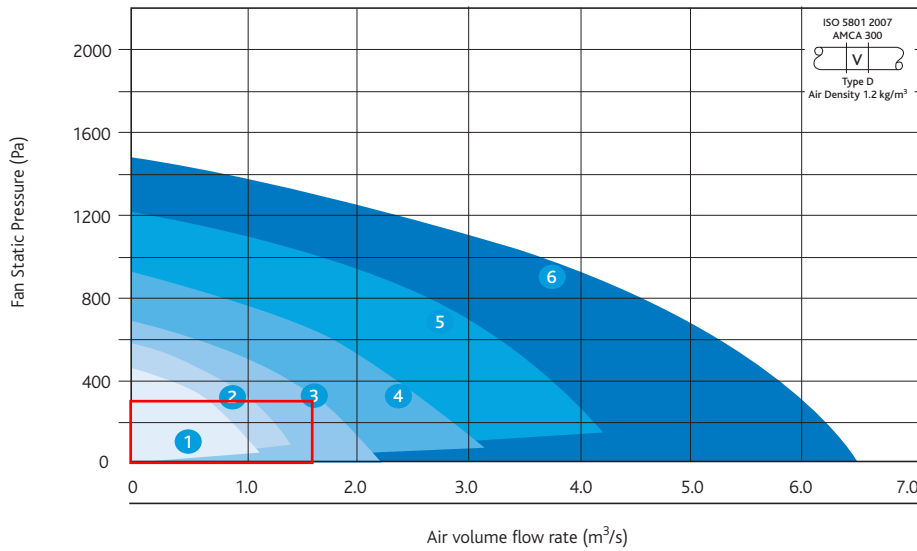

Casing

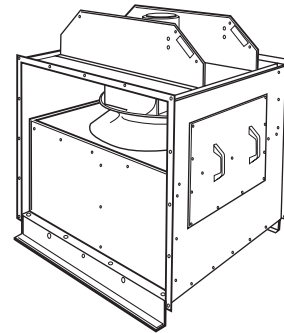

Squif - 6 pole

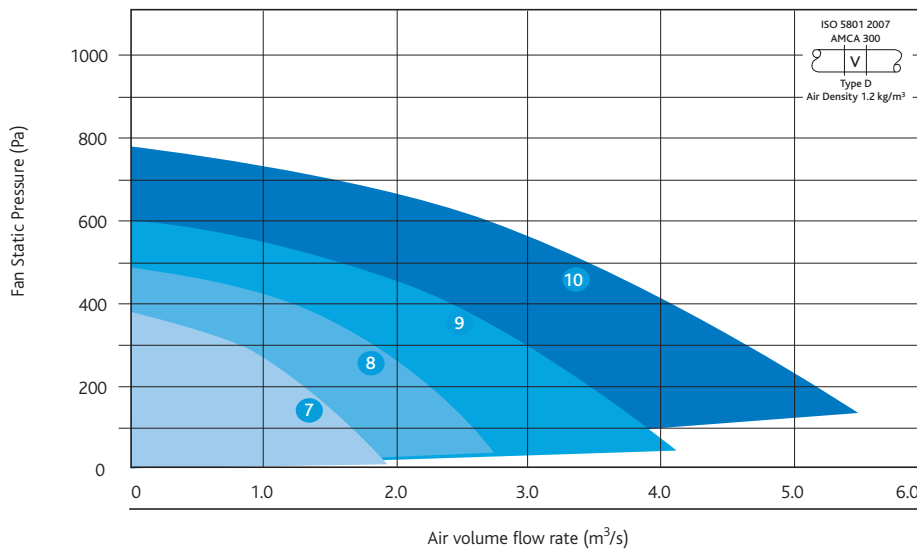

Code descriptions

**SQFA 4 1 - 3 ES B C**



1. Squif range
2. A = Ambient
3. Pole (4 or 6)
4. Curve No.
5. Phase (1 or 3)
6. ES = Full Ecosmart controls – BMS interfaces and commissioning controls (as 6 & 7 below) full compatibility with Ecosmart sensors.
7. B = BMS interfaces 0-10V, volt free run and fail indication.  
Commissioning/speed control built in Adjustable trickle and boost if required.
8. C = Commissioning/speed control built in.  
Adjustable trickle and boost if required.  
All the above control options are pre-programmed with a soft start function  
The above control options are provided in a purpose made module, mounted remote from the unit.  
Other controls to be specified separately please contact Nuair for details.



SQUIF EXTRACT FANS

ELECTRICAL & SOUND

Curve	Code	Phase	RPM	Motor Power (kW)	FLC (amps)	SC (amps)	SC ★/▲	Data Type	Sound Power Levels (dB re 10 <sup>-12</sup> W)							dBA @ 3m
									Octave band mid frequency (Hz)							
									125	250	500	1K	2K	4K	8K	
1	SQFA41-3	3	1450	0.37	1.1	5.2	-	I	90	79	70	70	70	69	62	50
	SQFA41-1	1	1410	0.37	2.8	11.2		O	91	74	68	74	75	70	64	
2	SQFA42-3	3	1450	0.75	2	9.0	-	I	92	82	77	74	76	75	67	53
	SQFA42-1	1	1370	0.75	5.4	21		O	93	78	74	78	80	77	69	
3	SQFA43-3	3	1450	1.1	2.5	12	-	I	95	83	79	77	78	78	71	56
	SQFA43-1	1	1420	1.1	7	35		O	96	79	77	82	83	79	73	
4	SQFA44	3	1450	2.2	4.8	28.8	-	I	93	89	82	77	80	80	71	58
								O	87	86	87	81	82	82	68	
5	SQFA45	3	1450	4	9.1	59	-	I	99	87	85	85	84	83	81	62
								O	100	83	82	89	89	84	83	
6	SQFA46	3	1450	7.5	15.2	108	-	I	103	92	86	86	85	86	83	63
								O	92	90	91	89	87	87	81	
7	SQFA61	3	960	0.75	2.1	8.82	-	I	89	84	75	70	73	73	64	47
								O	83	81	80	74	75	75	61	
8	SQFA62	3	960	1.1	3	13.2	-	I	96	83	78	76	75	74	72	56
								O	97	78	76	80	79	75	74	
9	SQFA63	3	960	2.2	5.9	28.9	-	I	100	87	79	76	76	77	73	59
								O	101	82	77	80	80	78	75	
10	SQFA64	3	960	4	9.4	61.2	20.4	I	103	91	82	79	77	77	74	62
								O	104	86	80	83	82	78	76	

The electrical and sound information in the table is nominal. Breakout dBA@3m is spherical, free field. Start currents (sc) are DOL. \* Motor electrical supply, 1=1 phase (230V, 50Hz) 3=3phase (400V, 50Hz) I - Induct Inlet O - Induct Outlet.

QUICK SELECTION GUIDE

SQUIF

Fan unit	Frequency Inverter	Standard silencers	Long silencers	Flexible Connectors	Fan Guards	AV Mounts
SQFA41-3	3ISC1.2A	SQFS1S	SQFS1L	SQFF1	SQFGD1	NAV2
SQFA41-1	-	SQFS1S	SQFS1L	SQFF1	SQFGD1	NAV2
SQFA42-3	3ISC2.6A	SQFS2S	SQFS2L	SQFF2	SQFGD2	NAV2
SQFA42-1	-	SQFS2S	SQFS2L	SQFF2	SQFGD2	NAV2
SQFA43-3	3ISC3.3A	SQFS3S	SQFS3L	SQFF3	SQFGD3	NAV2
SQFA43-1	-	SQFS3S	SQFS3L	SQFF3	SQFGD3	NAV2
SQFA44	3ISC5.6A	SQFS4S	SQFS4L	SQFF4	SQFGD4	NAV5
SQFA45	3ISC12.5A	SQFS5S	SQFS5L	SQFF5	SQFGD5	NAV5
SQFA46	3ISC15.6A	SQFS6S	SQFS6L	SQFF6	SQFGD6	NAV3
SQFA61	3ISC7.3A	SQFS4S	SQFS4L	SQFF4	SQFGD4	NAV3
SQFA62	3ISC5.6A	SQFS5S	SQFS5L	SQFF5	SQFGD5	NAV4
SQFA63	3ISC5.6A	SQFS7S	SQFS7L	SQFF6	SQFGD6	NAV4
SQFA64	3ISC8.8A	SQFS8S	SQFS8L	SQFF7	SQFGD7	NAV6

DIMENSIONS

SQUIF DIMENSIONS (mm) AND WEIGHTS

Unit size	A	B	C	D	E	F	G	H	M	Weight (Kg)
SQFA41-3	634	500	500	532	532	26.5	273	227	193	52
SQFA41-1	634	500	500	532	532	26.5	273	227	193	52
SQFA42-3	692	700	600	730	630	32	382	318	215	60
SQFA42-1	692	700	600	730	630	32	382	318	215	60
SQFA43-3	750	750	650	780	680	32	412	338	231	70
SQFA43-1	750	750	650	780	680	32	412	338	231	70
SQFA44	820	800	700	830	730	32	440	360	290	100
SQFA61	820	800	700	830	730	32	440	360	290	100
SQFA45	901	900	800	930	830	32	490	410	290	150
SQFA62	901	900	800	930	830	32	490	410	290	150
SQFA46	994	1000	900	1030	930	32	546	454	387	255
SQFA63	994	1000	900	1030	930	32	546	454	387	255
SQFA64	1114	1100	1000	1130	1030	32	600	500	387	315

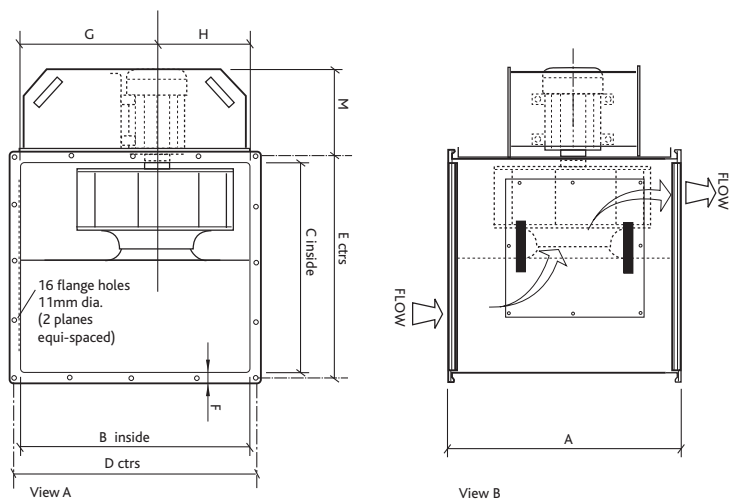
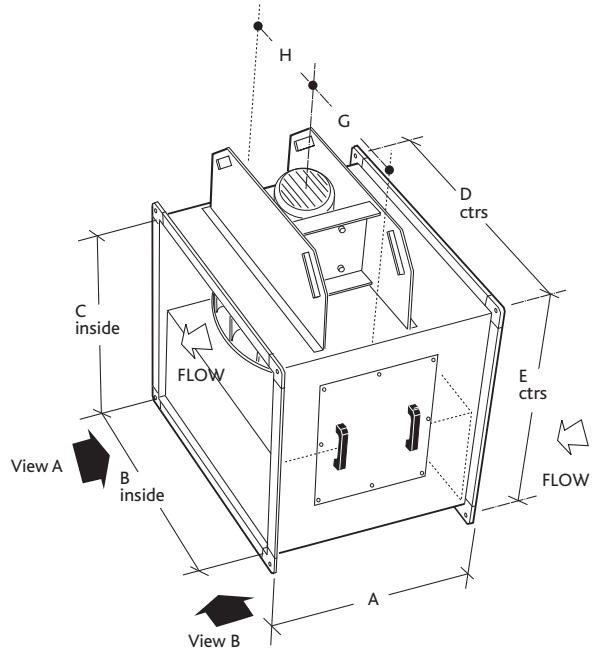

ANCILLARIES FOR SQUIF UNITS

DOUBLE FLANGED FLEXIBLE CONNECTOR (mm)

Flexible duct material is flame proof. Heat resistance is 400°C with excellent resistance to chemicals, ozone, oil and grease. The connector is air-tight, waterproof and tested to BS476 Part 7.

Code	Squif Fan	A	B	C	F	E
SQFF 1	SQFA41-3 SQFA41-1	150	560	560	532	532
SQFF 2	SQFA42-3 SQFA42-1	150	760	660	730	630
SQFF 3	SQFA43-3 SQFA43-1	150	810	710	780	680
SQFF 4	SQFA44 SQFA61	150	860	760	830	730
SQFF 5	SQFA45 SQFA62	150	980	880	930	830
SQFF 6	SQFA46 SQFA63	150	1080	980	1030	930
SQFF 7	SQFA64	150	1180	1080	1130	1030

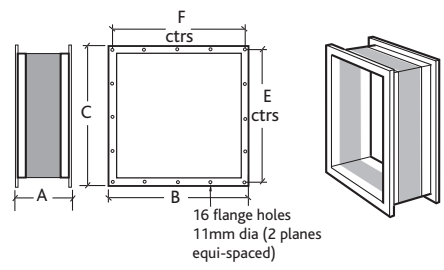

**ANCILLARIES FOR SQUIF UNITS CONT.**

**GUARD FOR SQUARE FANS (mm)**

Manufactured from galvanised steel wire or polyester coated mild steel.  
 Resistance to airflow is negligible.

Code	Squif Fan	A	B	C
SQFGD 1	SQFA41-3 SQFA41-1	532	532	11
SQFGD 2	SQFA42-3 SQFA42-1	730	630	13
SQFGD 3	SQFA43-3 SQFA43-3	780	680	13
SQFGD 4	SQFA44 SQFA61	830	730	13
SQFGD 5	SQFA45 SQFA62	930	830	13
SQFGD 6	SQFA46 SQFA63	1030	930	13
SQFGD 7	SQFA64	1130	1030	13

**Silencers**

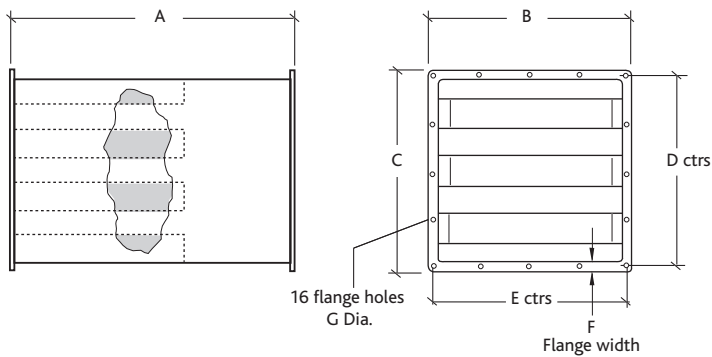

NOTE: The above diagram is for illustration purposes only. The splitter should be orientated vertically.

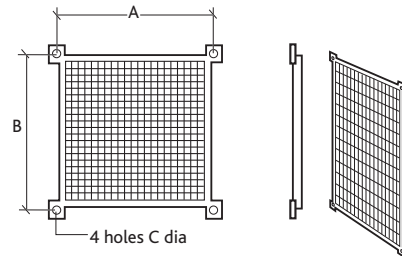

Figure 1. End view of recommended vertically mounted unit installation (bracket supplied).

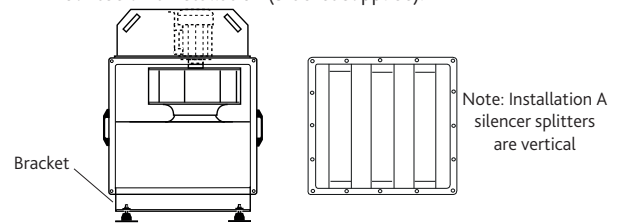
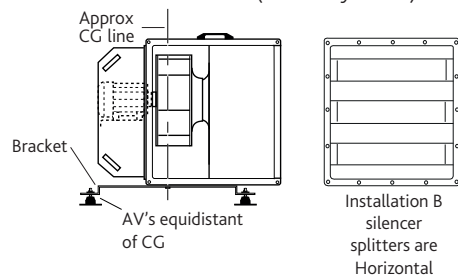

Figure 2. End view of non-recommended horizontally mounted unit installation (bracket by others).



**SQUIF LONG SILENCERS DIMENSIONS (mm) & WEIGHTS**

Matching Unit	Attenuator Code	Dynamic insertion loss (db)							Dimensions & Weights							Weight	
		125	250	500	1K	2K	4K	8K	A	B	C	D	E	F	G	Kg	Z
SQFA41-3	SQFS1L	-8	-12	-32	-42	-33	-32	-18	1200	560	560	532	532	26.5	11	38	36.8
SQFA41-1	SQFS1L	-8	-12	-32	-42	-33	-32	-18	1200	560	560	532	532	26.5	11	38	36.8
SQFA42-3	SQFS2L	-8	-12	-32	-42	-33	-32	-18	1200	760	660	630	730	32	11	43	30.5
SQFA42-1	SQFS2L	-8	-12	-32	-42	-33	-32	-18	1200	760	660	630	730	32	11	43	30.5
SQFA43-3	SQFS3L	-8	-12	-32	-42	-33	-32	-18	1200	810	710	680	780	32	11	46	30.5
SQFA43-1	SQFS3L	-8	-12	-32	-42	-33	-32	-18	1200	810	710	680	780	32	11	46	30.5
SQFA44	SQFS4L	-8	-12	-32	-42	-33	-32	-18	1200	860	760	730	830	32	11	60	10.9
SQFA61	SQFS4L	-8	-12	-32	-42	-33	-32	-18	1200	860	760	730	830	32	11	60	10.9
SQFA45	SQFS5L	-8	-12	-32	-42	-33	-32	-18	1200	980	880	830	930	32	12.5	91	5.47-
SQFA62	SQFS5L	-8	-12	-32	-42	-33	-32	-18	1200	980	880	830	930	32	12.5	91	5.47
SQFA46	SQFS6L	-8	-12	-32	-42	-33	-32	-18	1200	1080	980	930	1030	32	12.5	98	5.47
SQFA63	SQFS7L	-8	-12	-32	-42	-33	-32	-18	1200	1080	980	930	1030	32	12.5	116	1.54
SQFA64	SQFS8L	-8	-12	-32	-42	-33	-32	-18	1200	1180	1080	1030	1130	32	12.5	122	1.54

Note: Air Pressure Drop of Attenuator (Pa) = Z x Q<sup>2</sup> where Z = Factor listed in table above Q = Air Volume Flow Rate (m<sup>3</sup>/s)

SILENCERS CONT.

SQUIF SHORT SILENCERS DIMENSIONS (mm) & WEIGHTS

Matching Unit	Attenuator Code	Dynamic insertion loss (db)							Dimensions & Weights							Weight	
		125	250	500	1K	2K	4K	8K	A	B	C	D	E	F	G	Kg	Z
SQFA41-3	SQFS1S	-4	-8	-18	-24	-19	-16	-11	900	560	560	532	532	26.5	11	15	36.8
SQFA41-1	SQFS1S	-4	-8	-18	-24	-19	-16	-11	900	560	560	532	532	26.5	11	15	36.8
SQFA42-3	SQFS2S	-4	-8	-18	-24	-19	-16	-11	900	760	660	630	730	32	11	29	30.5
SQFA42-1	SQFS2S	-4	-8	-18	-24	-19	-16	-11	900	760	660	630	730	32	11	29	30.5
SQFA43-3	SQFS3S	-4	-8	-18	-24	-19	-16	-11	900	810	710	680	780	32	11	32	30.5
SQFA43-1	SQFS3S	-4	-8	-18	-24	-19	-16	-11	900	810	710	680	780	32	11	32	30.5
SQFA44	SQFS4S	-4	-8	-18	-24	-19	-16	-11	900	860	760	730	830	32	11	42	10.9
SQFA61	SQFS4S	-4	-8	-18	-24	-19	-16	-11	900	860	760	730	830	32	11	42	10.9
SQFA45	SQFS5S	-4	-8	-18	-24	-19	-16	-11	900	980	880	830	930	32	12.5	61	5.47
SQFA62	SQFS5S	-4	-8	-18	-24	-19	-16	-11	900	980	880	830	930	32	12.5	61	5.47
SQFA46	SQFS6S	-4	-8	-18	-24	-19	-16	-11	900	1080	980	930	1030	32	12.5	68	5.47
SQFA63	SQFS7S	-4	-8	-18	-24	-19	-16	-11	900	1080	980	930	1030	32	12.5	81	1.54
SQFA64	SQFS8S	-4	-8	-18	-24	-19	-16	-11	900	1180	1080	1030	1130	32	12.5	86	1.54

Note: Air Pressure Drop of Attenuator (Pa) = Z x Q<sup>2</sup> where Z = Factor listed in table above Q = Air Volume Flow Rate (m<sup>3</sup>/s)

CONTROLS

ECOSMART CONTROL (mm)

Fan code	A (mm)	B (mm)	C (mm)	Weight Kg	Drill D (mm)	Pattern E (mm)
ES-ISC1.2A	230	325	410	6	340	298
ES-ISC2.4A	230	325	410	6	340	298
ES-ISC3.3A	230	325	410	6	340	298
ES-ISC4.1A	230	325	410	6	340	298
ES-ISC5.6A	290	390	455	14	470	373
ES-ISC7.3A	290	390	455	14	470	373
ES-ISC8.8A	290	390	455	14	470	373
ES-ISC12.5A	290	390	455	20	470	373
ES-ISC15.6A	290	390	455	20	470	373
ES-ISC23.1A	290	390	455	20	470	373
ES-ISC38.0A	355	525	805	40	710	510

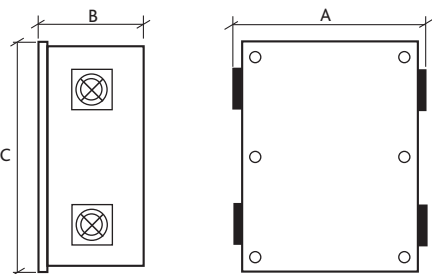

Please note:

- Control selected by ensuring the fan's flc is below stated in the ES-ISC code e.g. fan is 7 amps then controller will be ES-ISC7.7A.
- The mains power supply to the controller must be appropriately sized and installed via a local isolation switch (by others). The isolator must also accommodate the switched live (if used). The mains supply from the ecosmart controller to the fan must be appropriately sized, not exceeding 25 metres and must be a screened power cable, earthed at both ends. A four point glanding plate is formed from the base of the control and in order to main EMC compliance, a Zerohm EMC glanding kit is supplied. An isolator should be located adjacent to the fan.
- Contra and run and standby fans will require two controls, one for each fan for run and standby use ES-ISCT cone control.
- All integrated sensors plug directly into the control panel.
- Refer to product datasheet No. 671432 for further information.

CONTROLS CONT.

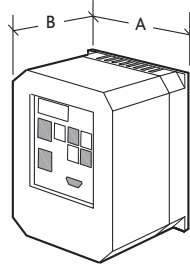

**INVERTER SPEED CONTROL (mm)**

Code	Motor Kw	A	B	C	Weight Kg
3ISC1.2A	0.37	70	142	280	1.5
3ISC1.9A	0.55	70	142	280	1.5
3ISC2.4A	0.75	70	142	280	1.7
3ISC3.3A	1.1	70	142	280	1.7
3ISC4.1A	1.5	70	142	280	1.7
3ISC5.6A	2.2	70	142	280	1.7
3ISC7.3A	3	70	142	280	1.7
3ISC8.8A	4	70	142	280	1.7
3ISC12.5A	5.5	169	177	299	3.5
3ISC15.6A	7.5	169	177	299	3.5
3ISC23.1A	11	169	177	299	3.5
3ISC31.0A	15	260	177	320	5
3ISC38.0A	18.5	260	177	320	5
3ISC44.0A	22	260	177	320	5
3ISC59.0A	30	260	177	320	24
3ISC72.0A	37	260	177	320	24
3ISC87.0A	45	260	177	320	24

The inverters are microprocessor controlled and use state of the art technology to produce variable output frequency to control the speed of 3 phase squirrel cage motors. In addition to speed control, the inverters offer a number of built in features:

- Soft start to reduce electrical and mechanical load.
- Infinitely variable speed adjustment or pre-set steps.
- Motor over-current detection.
- Alarm signals.
- Proportional control using a 0-10V signal from an external sensor.

All inverters are supplied complete with EMC filter with external filters being used for units above 7.5kW. To ensure the installation complies with EMC requirements, the use of screened power and signal cables are essential. The inverter can be operated over a wide ambient temperature range, 0°C to 50°C and in any clean indoor environments. To ensure safe and trouble-free operations, do not install the inverter near any heat source or in environment containing pollutants, e.g. dust, corrosive gas/vapours or be subjected to water spray or condensation. The inverter can be configured to suit the control regime required for the ventilation system. This can be simple manual control using the front panel of the inverter through to fully automated control via BMS. Please contact our technical support department to discuss your specific needs. All inverters use 400V 3 phase 50Hz power supply.

Please note that the selection should be based on the full load current of the fan NOT the motor rating.



WIRING - SQUIF

Two speed motors DOL starting on both speeds

Motor Terminal Box

Note: HIGH SPEED -  
Supply U2 V2 W2  
Link U1 V1 W1  
LOW SPEED  
Supply U1 V1 W1

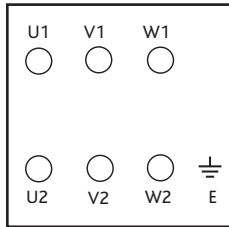

400V 3 phase 50Hz supply

Observe the motor plate and connection details.  
3 phase two speed tap/pam wound motors require a three contactor control. 3 phase Dual wound motors require a two contactor control.

Single phase single speed

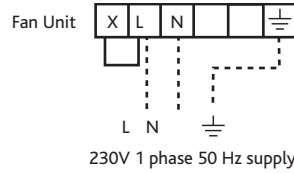

3 phase units with matched frequency inverter

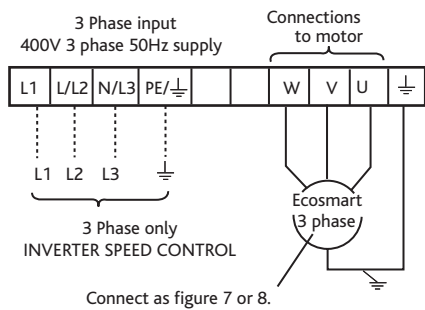

Notes:  
Total length of motor leads should not exceed 50 mtrs. If a screened motor cable is used, maximum length should be 30 mtrs. Consult our Technical Department if you wish to use longer leads. Inverters are configured to suit specific fans and control applications as described on the Customer Order.

3 phase units up to 3KW

3 phase motors are connected directly to the Motor Terminal Box.

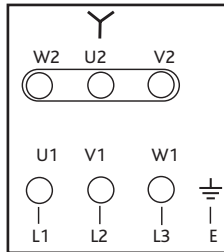

3 phase units 4KW and above

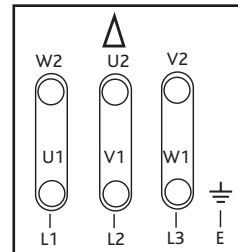

3 phase (ESISC - Ecosmart Control)

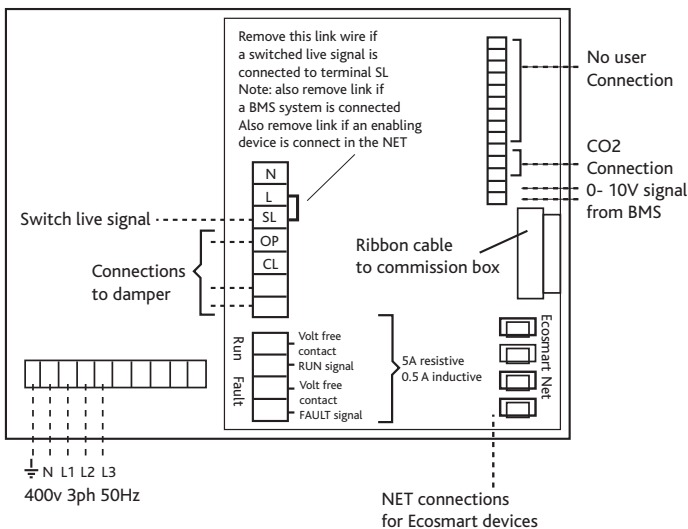

Set up/Commissioning Box

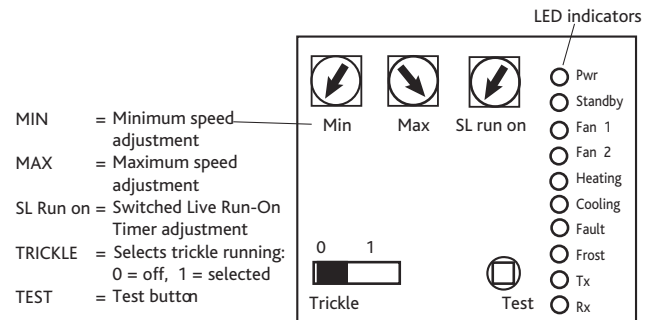

## CONSULTANTS SPECIFICATION

### SYSTEM SPECIFICATION

The ventilation fan Unit shall be configured and arranged as detailed on the drawings and in accordance with the schedule of equipment and shall be of the SQUIF type as manufactured by Nuair. The units shall be manufactured heavy gauge galvanised steel. The general construction is to class A leakage.

The fan impeller and motor shall be selected to provide the most energy efficient solution conforming to part L regulations and shall be direct drive with IE2 high efficiency motors to EN60034-30 as standard. The fan impeller shall be a high efficiency backward curved centrifugal design, manufactured in galvanised steel and the motor shall be positioned outside the ventilation airflow path.

The contractor shall allow for all necessary ductwork transformations to and from the fan unit and any associated components in accordance with the manufacturers recommendations, DW 144 and general good practice.

The unit and ancillaries shall be of the SQUIF type as manufactured by Nuair Ltd.

### CONTROL SPECIFICATION

All three phase units can be supplied with the following controls. Single phase units cannot be speed controlled

#### 1. ECOSMART CONTROLS

The compact Ecosmart control system complete with all necessary controls to facilitate the operation of the ventilation system. It shall be come complete with factory fitted Ecosmart PCB which will control the fan unit within the desired design parameters and provide the interface between all external control devices and the unit itself.

The fan unit shall have the following energy saving components integrally mounted, pre-wired to interface with the purpose made PCB, all components pre-wired, configured and factory fitted by the manufacturer: -

- Integral Frequency inverter/speed controller.
- Integral maximum and minimum speed adjustment for commissioning.
- Integral adjustable run on timer.
- Integral BMS interfaces – 0-10V speed adjustment.
- Integral BMS interfaces – Volt free failure and status indication.
- Integral background ventilation switch (trickle switch).
- Multiple IDC sockets for interconnection of sensors or fans using pre-plugged 4-core low voltage cable.

### ECOSMART SYSTEM OPERATION

The Ecosmart controls will enable the unit to automatically vary its speed as it receives signals from one of the interconnected sensors. When the signal is received the fan shall either increase speed gradually until the required level is achieved or it will work on a trickle and boost principle. This will then move the fan duty point from trickle/background ventilation rate to the required boost ventilation rate. Both the trickle and boost rates are infinitely variable, easy to adjust and remove the need of a main balancing damper.

#### 2. BMS INTERFACES

The fan unit shall be provided with the following integrated BMS interfaces:

- 0 - 10 volt contacts to provide a full BMS interface. This will enable the following functions:-
  - Switch the unit on/off.
  - Switch from low speed to high speed.
  - Full speed control facility.
- 2 No. Volt free contacts to provide fan run and failure indication to provide system status.
- An integrated commissioning/speed control to accurately commission the system, with minimum and maximum speeds easily adjusted via a miniature dial, as recommended in Part L. This will enable the unit to be configured to run between set parameters thus saving motor power and limiting noise.

#### 3. COMMISSIONING SET UP

The fan unit shall be provided with an integrated commissioning/speed control to accurately commission the system, as recommended in Part L, minimum and maximum speeds easily adjusted via miniature dial. The commissioning set up facility directly controls the integrated speed control/frequency inverter.

The Fan unit shall have a 3 year warranty.  
Ecosmart Squif shall have a 5 year warranty.

All equipment shall be as manufactured by Nuair Ltd.