

WINDOW ELEVATIONS
1:20 scale

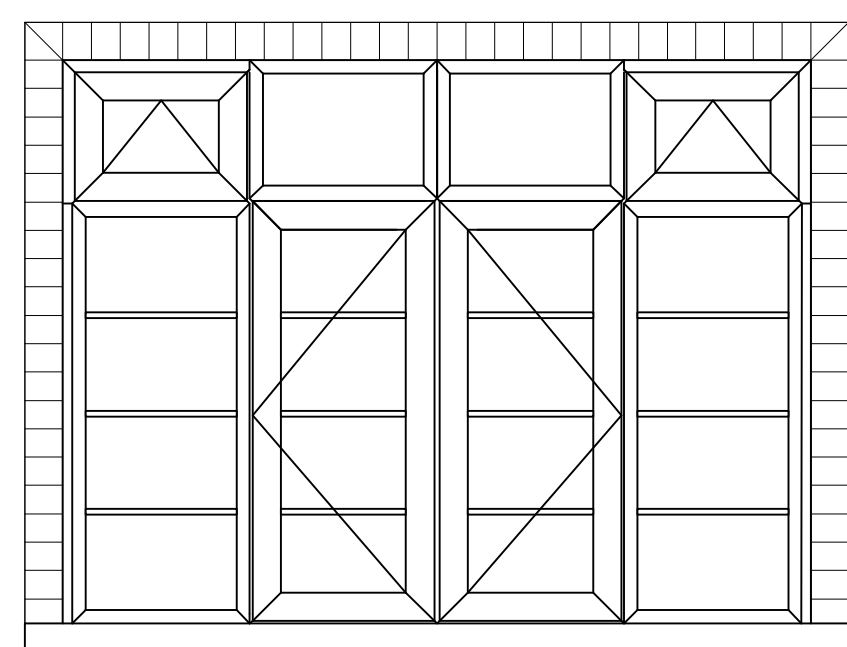

Master Bedroom

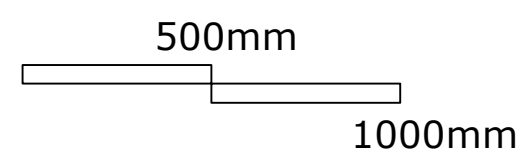
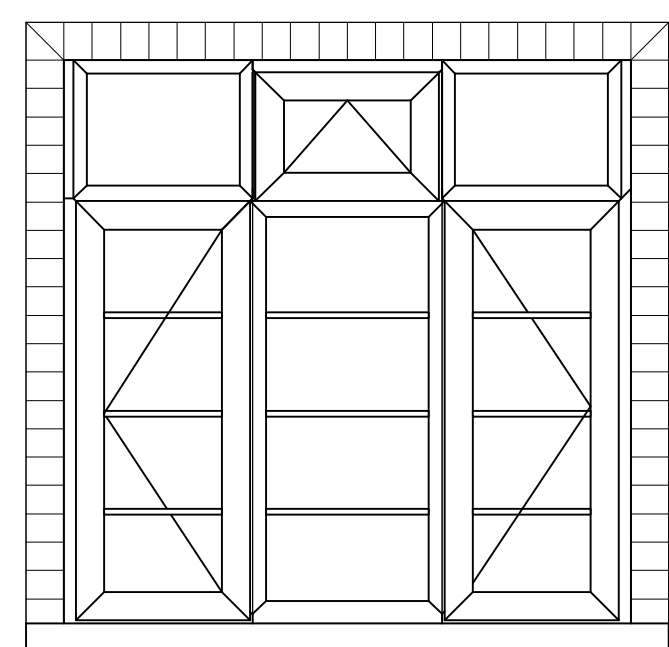

Bedroom 2

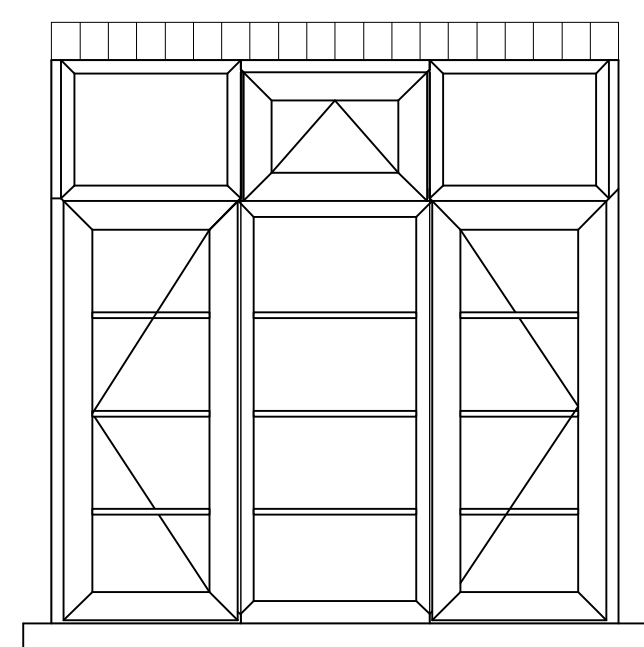

Bedroom 3

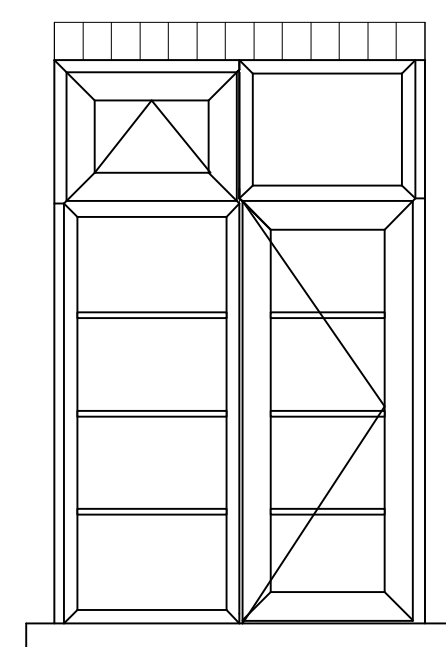

Kitchen 1

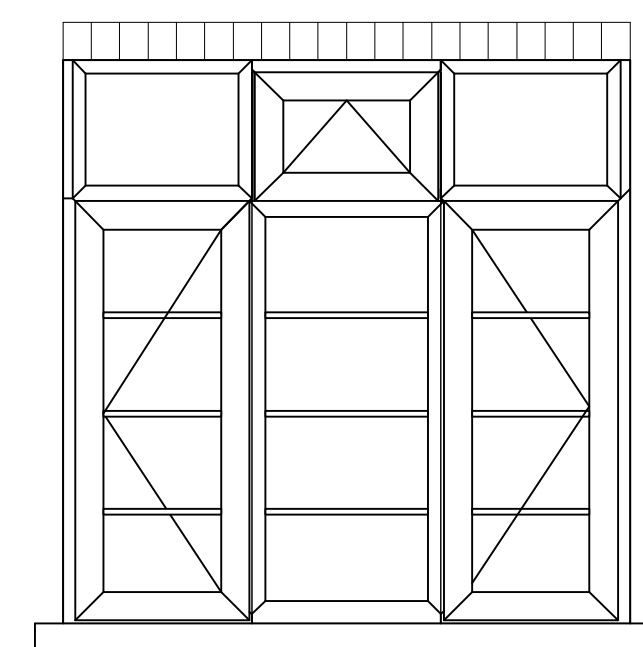

Kitchen 2

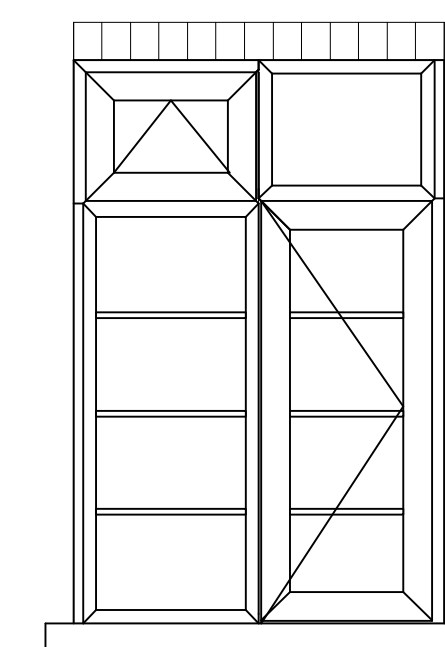

Bathroom

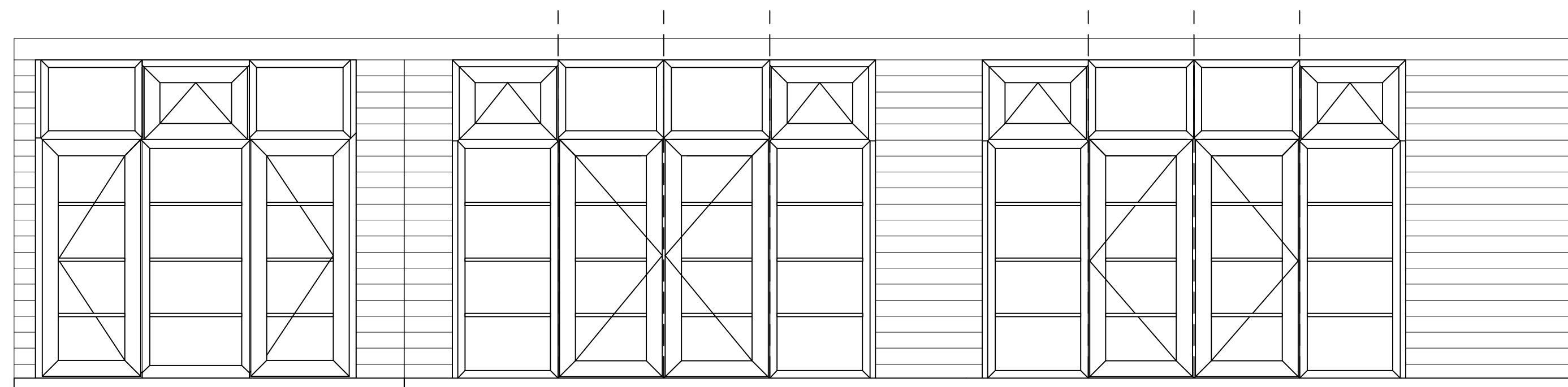

Lounge 1

Bay 1

Bay 2

Bay windows are faceted and arranged along a curve - elevations show individual panes folded out

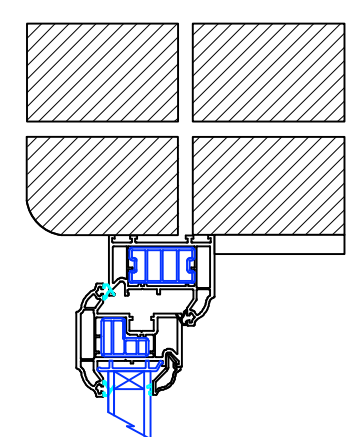

VERTICAL SECTION THROUGH OPENING TOPLIGHT, AND FIXED LOWER PANE

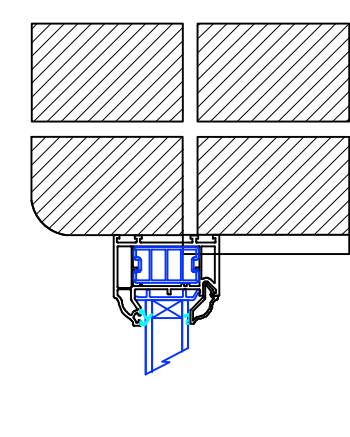

VERTICAL SECTION THROUGH FIXED TOPLIGHT, AND OPENING LOWER PANE

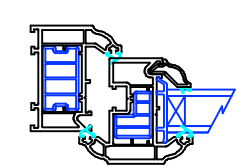

HORIZONTAL SECTION THROUGH TWO OPENING CASEMENTS SIDE BY SIDE

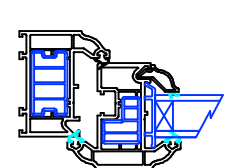
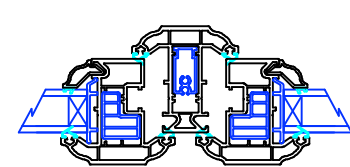

HORIZONTAL SECTION THROUGH OPENING CASEMENT AND FIXED PANEL TO SIDE

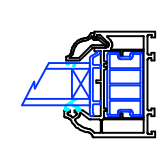
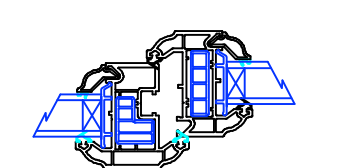

WINDOW DETAILS
1:5 scale

