

9 Green Roofs



We lead the way in the development of all types of green roofs having supplied and installed solutions for over 40 years.

We provide the complete package of waterproofing systems and associated landscaping components to ensure that every green or blue roof is fully compatible.

■ Overview	170
■ Credentials	172
■ Intensive Green Roofs	176
■ Substrate-Based Systems	180
■ BioSOLAR Roof Vegetation	186
■ XF301 Sedum System	188
■ Technical Design	195

OVERVIEW OF GREEN ROOFS

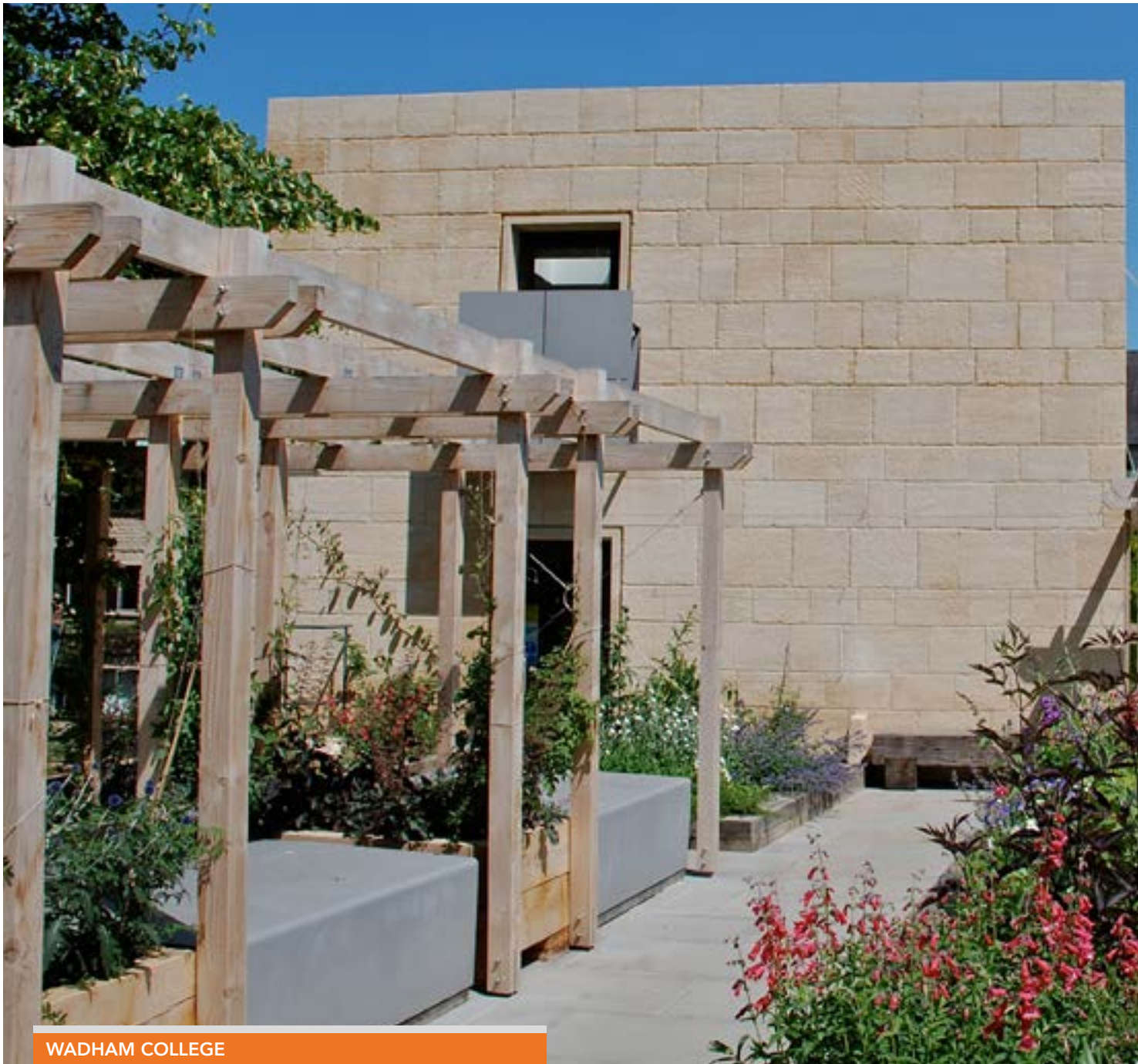

WADHAM COLLEGE

Location: **Oxford**

"The Bauder Hot Melt System with intensive green roof landscaping offers incredible durability, versatility and cost effectiveness. The roof garden has transformed the graduate centre at Wadham and undeniably assisted in maximising the building's potential. Bauder provided the highest standards of technical support throughout the works and delivered a single-point of contact roofing solution that met our exact specifications under one all-encompassing guarantee."

Tim Lee, Lee Fitzgerald Architects



We were the first company to introduce lightweight landscaping technology into the UK and Ireland, partnering on many prestigious projects since 1982. Our unrivalled expertise ensures we deliver any green or blue roof scenario, from recreational gardens and parks to simple low maintenance environmental greening and biodiverse ecological solutions.

Sedum System Non-Accessed Extensive Green Roof

All in one system comprising mature sedum species pre-grown on an integrated blanket with 20mm of extensive substrate. The system has been developed for use directly over our waterproofing.

Substrate Roofs Extensive Non-Accessed Green Roofs

Substrate green roofs are designed to be comparatively lightweight, work towards providing some storm water attenuation and support a wide variety of low maintenance plant species which are generally self-sustaining, and wind, frost and drought tolerant.

Biodiverse Habitats

Created to encourage a wider spread of birds, insects and plant species into the area and generally replicate the ecological environment of the site. This is particularly important if there are planning conditions or a local Biodiversity Action Plan (BAP) must be followed.

Pre-grown Vegetation Blankets

Designed to give instant greening to a roof. Two options are available; Bauder WB native wildflower blanket or a sedum mix in the Bauder SB substrate blanket.

Plug Planted Systems

The selection and location of each plant species can be controlled according to requirements which is ideal when the roof has a number of different aspects. We can supply over 100 different plugs: British Native Wildflowers, herbs, grasses to sedums and other succulents.

Seeded Roofs

Our unique range of British native seed mixes provides the specifier with a selection of seed blends to suit particular locations and are designed to meet BREEAM and BAP requirements.

BioSOLAR Roofs

Combining a green roof with a solar PV array where the substrate and vegetation provide ballast for the PV mounting. The system raises the modules above the substrate to allow liberal growing room for the plants.

Recreational Gardens, Terraces and Spaces Accessed Intensive Green Roofs

Rooftops and podiums where the design may include flowerbeds, lawns, shrubs and trees intermixed with paths, driveways and patios. The combinations of finishes will impact on the design, construction, drainage and components used to deliver to each element's requirements.

ENVIRONMENTAL CREDENTIALS

Aiding Biodiversity and Meeting a Biodiversity Action Plan (BAP)

A green roof can provide a range of natural habitats specifically designed to support particular species of plant, insect or wildlife. Designed for the local ecology, in which vegetation will establish and provide an environment for wildlife as well as insects and invertebrates. The provision of a healthy habitat in a place that could otherwise be empty encourages wildlife to remain in the area, providing wildlife corridors to support the natural colonisation of locally arising plants, birds and insects, boosting the resilience of species in the area.

Our wildflower blanket and Flora Seed Mixes are all specifically devised to meet BAP criteria through their inclusion of species within the RHS 'Perfect for Pollinators' and Flora Locale 'native origins criteria'.

Bauder works with Buglife, the invertebrate charity, to produce a range of habitat features that favour some of the UK's most vulnerable species.



Storm Water Management and SuDS

The specifically engineered outlet within a blue roof restricts the discharge of storm water to a calculated and predesigned flow rate to significantly slow down the volume of water leaving the site. As the storm passes, water continues to discharge from the roof at a controlled rate which helps to avoid downstream or localised flooding. (see chapter 10)

Green roofs can retain rainwater in the substrate, drainage/reservoir board and plants. This water is then used by the vegetation or evaporates back into the atmosphere. The FLL reports that, over the course of a calendar year, a green roof can frequently retain 40% of average rainfall on an extensive green roof with 20-40mm of substrate and sedum vegetation and 90% of average rainfall on an intensive green roof with over 500mm of substrate.

Improving Air Quality of Local Surroundings

Localised air quality is improved as the vegetation assists in filtering out both gaseous pollutants and dust particles, effectively purifying the air. Additionally, the natural evaporation of water from the plants and soil helps to cool and humidify the air, so lowering the ambient temperature and reducing the heat island effect.

Prof. Dr. H. J. Liesecke, the former chairman of the German FLL regulatory body, carried out tests at the University of Hanover to provide evidence of the natural air purifying effects of Xero Flor XF301 sedum system with its patented substrate.

The test container housing the sedums and mosses was filled with the waste gas from petrol and diesel engines and after 48 hours the pollution levels were measured showing a reduction by 95% within the period. A second chamber was also set up without vegetation as a comparative control.

In conclusion, extensive green roof systems effectively mitigate car emissions.

Urban Heat Island Effect

The urban heat island effect is the difference in temperature between urban areas and the surrounding countryside and is a result of large building surfaces reflecting and radiating solar, which will not dissipate fully overnight. The substrate of a green roof will absorb some of this heat and the natural evaporation of water from both the plants and soil helps to cool and humidify the air, thus lowering the ambient air temperature.

Recycled Content of Green Roof Components

Many recycled or waste materials are used within our green roof build ups to enable us to provide environmental solutions to the industry.

Water Retention and Drainage Layers

Our DSE 20, 40 and 60 boards all utilise recycled high density polyethylene which is easily moulded to create the cupped profile boards that provides water retention and multi-directional drainage.

Protection Layers

Our protection layers FSM600 and FSM1100 are made from a mixture of two recycled materials, reground polyester and polypropylene fibre, that are combined before being mechanically and thermally solidified to deliver a layer which prevents mechanical damage to the waterproofing beneath the green roof build up.

Our ProMat is made of granulate from recycled shredded tyres reformed and bound by Polyurethane to give a high protection layer against mechanical damage.

Our Ecomat product is a protective layer created from mechanically bonded recycled Polyester clothing and fabric.

Substrates and Growing Mediums

Our FLL compliant substrates are based around recycled crushed brick and composted recycled organic material to give growing mediums which correctly balance water storage, structural stability, water permeability and grain size distribution according to the requirements of the planting scheme.

Separation and Slip Layer

Our PE Foil allows the green roof to operate independently of the waterproofing system and is manufactured from recycled polyethylene granulate.

Recycling End of Life

The level of recycled content within our components clearly demonstrates that these products are then easily returned to the convention.

BREEAM

Building Research Establishment Environmental Assessment Method

breeam

Our green roofs have the potential to count towards BREEAM. If you are working to this assessment standard, please contact a member of our technical team, who can advise on best practice for your individual project.

Health and Wellbeing

This category encourages the health, wellbeing and safety of the building users through the design and specification to create a comfortable internal and external environment.

Hea 05 Acoustic performance

The building looks to meet acoustic performance standards under 1.a Sound Insulation with the criteria to 'Achieve the performance standards set out in Section 1 of Building Bulletin 93: Acoustic design of schools: performance standards, February 2015 (BB93)1 relating to airborne sound insulation between spaces and impact sound insulation of floors'

The Bauder XF301 sedum blanket system on a metal deck has been tested in accordance with BS EN ISO 140-18: 2006 to determine the sound intensity level within the building during heavy rainfall. The sedum plants intercept the impact of rainfall and mitigate the noise so that a figure of 33.5dB is achieved. (See Chapter 9)

Hea 07 Safe and healthy surroundings

A credit is available for an outside space that provides building users with an external amenity area.

An intensive green roof provides recreational gardens and amenity spaces on podiums and at roof top level to maximise the full potential of the building by utilising all available space within the structure's footprint.

Energy

This category encourages the specification and design of energy efficient building solutions towards sustainable use and management throughout the operation of the building's life.

Ene 01 - Reduction of energy use and carbon emissions

Any low or zero carbon technologies installed can be used to offset emissions arising from regulated and unregulated (for exemplary credits) energy consumption. The requirement details for a private wire arrangement to be in place, i.e. no grid sustainable energy purchase.

Bauder BioSOLAR photovoltaic solution creates local energy generation from renewable sources on green roofs where the installation method ensures the waterproofing beneath remains completely intact and without compromise. (See chapter 11)

Materials

This category focuses designers on reducing the environmental and social impact of construction products used on a project through the specification of efficient construction products with reduced environmental impact that are responsibly sourced and durable.

Mat 02 – Environmental impacts from construction products – Environmental Product Declarations (EPD)

The specification of products with a recognised environmental product declaration that has been independently verified and registered for its transparent communication of comparable information about the life-cycle impact of products.

Mat 03 – Responsible sourcing of construction products.

The section facilitates the selection of products that involve lower levels of negative environmental impact across the supply chain.

Bauder manufacturing processes hold ISO 14001:2015 Environmental Management Certification to measure and improve our impacts.

Green Roof Build Up Components

Many recycled or waste materials are used within our green roof components to enable us to provide environmental solutions to the industry.

Water Retention and Drainage Layers - Our DSE 20, 40 and 60 boards all utilise 100% recycled high density polyethylene moulded to create the cupped profile boards that provide water retention and multi-directional drainage.

Our Attenuation Cell 100 board is manufactured from recycled PolyPropylene.

Protection Layers - Our FSM 600 and 1100 are made from a mixture of recycled reground polyester and polypropylene fibre, which are combined before being mechanically and thermally solidified to create a layer to prevent mechanical damage to the waterproofing.

ProMat for intensive green roofs is made of granulate from recycled shredded tyres reformed and bound by Polyurethane to give a protective layer against mechanical damage.

Ecomat is a protective layer created from recycled Polyester clothing and fabric.

Substrates and Growing Mediums - Our substrates are based around recycled crushed brick and composted organic material to give growing mediums which balance water storage, structural stability, water permeability and grain size distribution according to the requirements of the planting scheme.

BREEAM *cont.*

Building Research Establishment Environmental Assessment Method

Separation and Slip Layer - PE Foil is manufactured from recycled polyethylene granulate. from construction and throughout the lifetime of the building.

Waste

This category focuses on the reduction of waste from construction and throughout the lifetime of the building.

Wst 01 Construction waste management

The reduction of excess and discarded construction materials through optimised design methods to minimise waste.

Bauder solution designs are created specifically to be efficient and minimise waste created onsite through excess product specification thus avoiding unnecessary material use in order to minimise waste going to landfill.

Wst 02 Use of recycled and sustainably sourced aggregates

Whilst BREEAM encourages the use of site sourced material. **GRO and Bauder recommendations** are that aggregate obtained from site is not used as a substitution for GRO and FLL compliant substrate, as the unknown content risks contaminated content to the living roof.

"To encourage the specification and use of more sustainably sourced aggregates." Bauder carefully select recycled material for use in their substrate to make the products 95%+ recycled whilst still compliant to GRO and FLL guidelines."

Land Use and Ecology

This category encourages sustainable land use, habitat protection and creation, and improvement of long-term biodiversity for the building's site and surrounding land.

Le 03 – Managing impacts on ecology

This section concentrates on avoiding or limiting negative ecological impacts associated with the site and surrounding areas as a result of the construction project and consequent building.

Bauder biodiverse green roofs help to conserve natural ecosystems and maintain the environmental asset, a matrix of habitats and specific plant species can be incorporated to meet the needs of the local biodiversity action plan (BAP) and the site ecology.

Le 04 – Ecological change and enhancement

The aim of this is to enhance ecological value of the area associated with the site in support of local, regional and national priorities. Exemplary level criteria is gained where significant Biodiversity Net Gain is achieved.

Bauder biodiverse green roofs can introduce and reinforce local native species flora and our wildflower blanket and seed mixes are all specifically devised to meet BAP criteria through their inclusion of species within the RHS 'Perfect for Pollinators' and Flora Locale 'native origin species'. Bauder also works with Buglife, the invertebrate charity, to produce a range of habitat features that favour some of the UK's most vulnerable species.

Le 05 – Long-term ecological management and maintenance

This section looks at ongoing monitoring, management and maintenance of the site and its habitats and ecological features, to ensure intended outcomes are realised for the long term.

Bauder green roof maintenance service delivers ongoing care of a green roof on a regular basis so that healthy plant growth of suitable species continues to provide a habitat for wildlife. We also provide maintenance information to allow building owners and asset managers to continue to maximise the building's asset value.

TECHNICAL CREDENTIALS

Adopting Standards

Throughout Europe, the standards most widely recognised as comprehensively covering green roofs are those of the Forschungsgesellschaft Landschaftsentwicklung Landschaftsbau (FLL). This independent foundation was set up by the German Government in 2002 and develops specific guidelines for green roof systems.

We have adopted these well respected standards, which cover all aspects of waterproofing, root protection, landscaping, installation and maintenance and we will continue to do so whilst also working in conjunction with the GRO Code of Best Practice for the UK.

Protection of the Waterproofing

A green roof protects the waterproofing from UV damage and thermal movement. Research has shown that the life expectancy of the waterproofing is significantly extended and in many cases may last the estimated design life of the building, which can eliminate future replacement costs.

Fire Testing

Bauder XF301 was the first sedum blanket in the UK to be awarded a fire rating by the Building Research Establishment. The full system, including the waterproofing and insulation was tested, and so the EXT. F.AA rating applies to the complete system and not just the sedum blanket covering.

With the recent standardisation of fire tests across Europe. Bauder's Sedum Blankets are proven to be "unrestricted and can be used anywhere on the roof" when tested to TS1187 with BS EN 13501-5 European Class rating B_{ROOF}(t4). (for more information on see pages 38-40)

Increased Efficiency and Output of a BioSOLAR PV Array

A green roof helps to maximise solar energy generation as the vegetation preserves ambient rooftop temperatures, keeping the modules at optimal output. The cooling effect increases panel output by up to 5-7%.

Aid to Planning Consent

Many local authorities favour planning proposals that incorporate green roofs within the application as this helps meet their targets on sustainable environment and support of priority species

Sustainable Urban Drainage is now part of legislation and is a critical part of planning. Blue roofs form part of the options available for SuDS.

The Flood and Water Management Act 2010 was introduced in England and Wales and implemented to better manage flood risk. The Act creates safeguards against rises in surface water drainage charges and protects water supplies for consumers. The Act gives levels of responsibility to local authorities to co-ordinate flood risk management in their area.

Many local planning authorities (LPAs) are adopting early perspectives that encompass Schedule 3 of the Act to bring in measures that prevent flooding. Within construction and development, planners are restricting the amount of rainwater leaving a site via the drainage system, limiting water egress to 5-10 litres per second per hectare, the same flow rates for regional greenfield sites.

Reduction of External Noise Within the Building

Green roofs have excellent acoustic qualities for both external sound (up to 3dB) and internal noise (up to 8dB). This can prove to be both economically and environmentally effective when used on structures close to airports or industrial developments.

Reduced Building Running Costs

The enhanced thermal performance provided by a green roof provides a more balanced temperature within the building. This reduces heating costs in the winter and air conditioning expenses during the summer.

Reduced Lifecycle Costs

The main reduction in lifecycle costs comes from the green roof providing protection from the damaging effects of the weather, which effectively 'ages' the waterproofing, thus the time span between replacement is extended significantly, and in many cases replacement will become unnecessary.

Offset Construction Costs

In large construction projects a green or blue roof can mean that storm water holding tanks are reduced in size or no longer required, as the roof itself will attenuate required rainfall.

Creates an Amenity Space

The roof is often an under utilised asset of a building, as it offers the unique potential to replace the land lost to the construction as reusable space. Large roof areas covering underground car parks can provide parkland or sports facilities.

Increases Property Value

A green roof is an additional asset, once created will maximise the property's potential value.

Productivity in the Workplace

Research has shown that people working in offices that overlook green spaces have a higher productivity than those with a poorer outlook on to hard, impervious buildings. The evidence shows that there is a reduction in stress levels if people have visual and personal contact with natural greenery and that physically they benefit from the cleaner air.

Health

Hospitals are greening overlooked roofs or incorporating rooftop garden areas for the benefit of patients as they find that this speeds recovery. Some patients are also encouraged to access the gardens and to actively maintain them as part of therapeutic exercise.

RECREATIONAL SPACES, GARDENS

Accessed Intensive Green Roof Systems



HOLYROOD STUDENT ACCOMMODATION

Location: **Edinburgh**

The main flat roof podium area located was waterproofed with 1,400m² of Bauder Plant E before then having soft and hard landscaping elements installed to provide a visually appealing, multi-purpose recreational area for students to socialise on. Other areas of the 4,000m² roof area were waterproofed with Bauder Thermofol PVC single ply system with PIR insulation for superior thermal performance.

AND TERRACES

The £110 million student accommodation on the Holyrood campus at the University of Edinburgh features a picturesque podium roof garden that is designed to foster a sense of community among students and increase the overall value of their experience.



Intensive green roofs provide recreational gardens and amenity spaces on podiums and at roof level, with all the benefits usually associated with ground level landscaping. Increasingly, buildings in city areas are constructed with a green roof on the underground car park to provide additional facilities, thereby maximising the full potential of the building by utilising all available space within the structure's footprint. Typically they will feature landscapes combining shrubs, perennial and herbaceous plants as well as grassed areas and even trees.

Semi-Intensive Green Roofs

This term is generally used to describe a planting scheme where the vegetation has been selected to benefit the building occupants. This may be for its aesthetic qualities or as a public space. The planting is normally in planters with adjacent hard landscaping.

Key Features

- Assists in maximising the building's potential.
- Provides valuable recreational space.
- Offers storm water management benefits due to the depths of substrate used, particularly when specified in conjunction with permeable paving.
- Increases the overall value of the property.

The plants used make a heavy demand on the green roof and will require maintenance, irrigation and management throughout the year to ensure the upkeep of the landscape and allow the vegetation to flourish.

It is important to first establish the landscape finish you are looking to achieve. There is little to restrict the scope for design, other than the overall weight of the system dictating the construction of the supporting structure and the height and level of exposure of the roof.

All our green roof systems meet with GRO and FLL Guidelines.

Specification Support



Specification downloads:
www.bauder.co.uk/technical-centre



Telephone helpline:
0845 271 8800



RECREATIONAL SPACES, GARDENS AND TERRACES

Example System Configurations

Our lightweight substrates combined with specially developed water storage and drainage components all ensure that the modern green roof can replicate a traditional landscape at roof level at only a fraction of the weight and with a substantially shallower build up.

It is crucial that an integrated approach is taken to the design and specification of both the waterproofing and landscaping components, so that the desired outcomes are achieved. We can work with you from the earliest design stage to ensure that your green roof project is successful.



PROJECTS

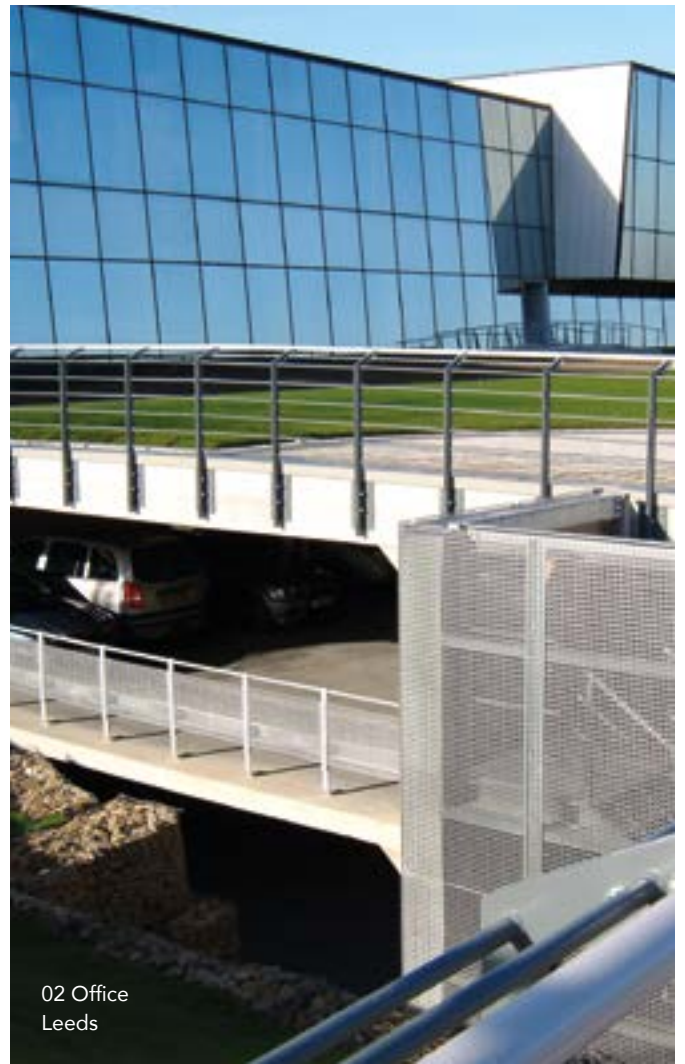

GREEN ROOFS

SUBSTRATE GREEN ROOF SYSTEMS

Non-accessed extensive green roof systems





A substrate-based green roof will often incorporate a mixed vegetation scheme of low maintenance plants chosen to suit the project and location.

These extensive green roof systems are primarily used for their ecological benefits or aesthetic appearance rather than for general access or for leisure purposes.

A traditional extensive substrate green roof system provides a depth of growing medium usually around 80-200mm to allow for the specification of a broader range of species and planting schemes. The plants are generally low maintenance, wind, frost and drought resistant and can be installed by different methods, including plug planting, vegetation mat and seeding.

Key Features

- Comparatively lightweight.
- Plants chosen to suit the project and location.
- Deep drainage and substrate layers enable excellent water retention to aid SuDS requirements.
- Creating natural habitats to encourage native plants, insect life and small wildlife to remain, so aiding biodiversity.
- Can be designed specifically to support particular flora and fauna.
- Aid to planning consent as biodiversity roofs help to meet local authority policies towards a sustainable environment.
- Aid to meeting BREEAM requirements of a development through points secured by the use of accredited native species plants.
- Cost effective on large roof areas.

An extensive substrate system allows a wider choice of suitable plants for the client. There are two types of substrate used within these systems designed to support the different forms of vegetation. Our extensive substrate is specifically for sedum planting schemes and our biodiverse substrate supports British native species.

Manually planting individual plants in plug format gives the client a much greater choice of species and the opportunity to plan the layout. This can be of particular benefit when the roof is to be overlooked and where the roof areas to be greened are either partially or wholly in shade.

All our green roof systems comply with GRO and FLL Guidelines.

GREEN ROOFS

Specification Support



Specification downloads:
www.bauder.co.uk/technical-centre



Telephone helpline:
 0845 271 8800



SUBSTRATE GREEN ROOF SYSTEMS

Example System Configurations

Substrate-based extensive green roofs can incorporate a variety of vegetation and hard landscaping finishes.

Vegetation Mats

The installation of a pre-grown vegetation mat allows instant coverage of the roof. Native wildflower blanket, Bauder WB, meets the growing demand to satisfy the requirements of BREEAM and should meet the biodiversity action plan for the site.

Bauder SB vegetation is a mature sedum blanket with a broad mix of sedums, 12-14 species, and is typically grown for a year prior to installation for excellent coverage.

Plug Planting

This method gives the client both a much greater choice of plant species and the opportunity to plan the layout. The individual immature plants or 'plugs' are planted into the substrate, which can then grow on to give good cover over the next few years.

Seeding

An economical and practical method for vegetating larger roof areas. Our seed mixes are designed for the harsh conditions on a roof. Plant establishment and coverage will take 18-24 months, depending upon the time of year sowing takes place and the weather conditions during the period of establishment.

Biodiverse Options

Bauder's range of seed, plug and blanket can be used in combination to create the matrix of habitat and surface finishes required. Bauder has allied with Buglife (the invertebrate charity, buglife.org.uk) to produce roofs designed with dead wood, sand/stone piles as well as dew ponds etc to give a truly sustainable insect friend environment.



Vegetation Mat



Seeded Roof



Plug Plants



Biodiverse Habitat

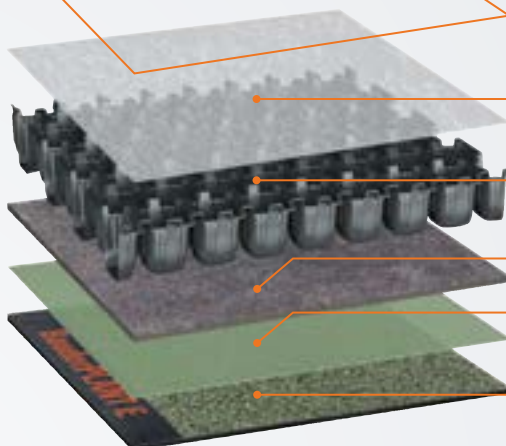

Bauder Filter Fleece

filtration layer that prevents substrate fines from washing into the drainage layer.

Bauder DSE40

40mm water storage layer that provides multi directional drainage.

Bauder FSM600 Protection Mat

recycled polyester and polypropylene fibre mix.

Bauder PE Foil (specified in some projects)

polyethylene foil separation and slip layer manufactured from recycled granules.

Bauder Waterproofing (all four types are suitable)

shown here with root resistant, SBS modified bitumen membrane reinforced with 250g/m² recycled spunbond polyester.

 www.bauder.co.uk/technical-centre

PROJECTS



Barclays Bank Tower
London



Biodiverse roof using Bauder
Wildflower Seed



Bord Gáis Networks
Dublin



Wildflower blanket
Private residence, Ullapool



GREEN ROOFS

SUBSTRATE PITCH ROOF SYSTEMS

Example System Configurations Over 10°

An extensive substrate system on a pitch greater than 10° requires a water retention and storage board that will hold the substrate firmly in place and be sufficiently rigid to prevent board flexure and manage the imposed shear load.

The extensive or biodiverse substrate is applied directly to the profiled surface of the board so that the green roof is stabilised whilst retaining sufficient levels of water to support the vegetation.

Sedum Vegetation on Bauder Extensive Substrate

upto 15 sedum species, drought and wind hardy.

Vegetation on Bauder Biodiverse Substrate

generally provided through plug planting, vegetation mat or seeding. If selected species are required, these can be specified to suit the project and location.

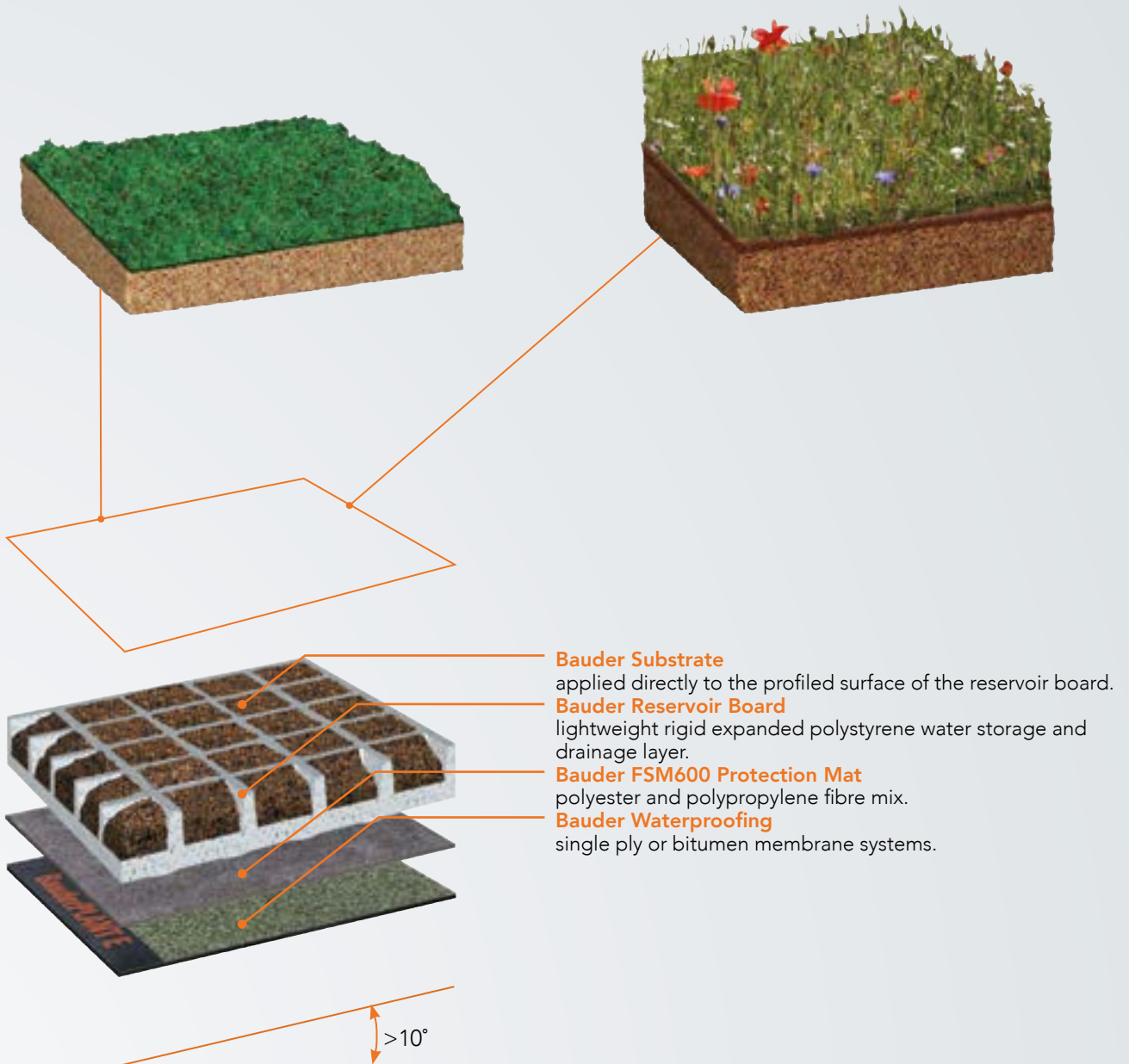

Bauder Substrate

applied directly to the profiled surface of the reservoir board.

Bauder Reservoir Board

lightweight rigid expanded polystyrene water storage and drainage layer.

Bauder FSM600 Protection Mat

polyester and polypropylene fibre mix.

Bauder Waterproofing

single ply or bitumen membrane systems.



PROJECTS



Plug planted vegetation on
East Anglian Children's Hospice



Fulham Jetty



Pines Calyx
Dover, Kent

GREEN ROOFS

BIOSOLAR GREEN ROOF FINISH

Example System Configurations

Bauder BioSOLAR is a revolutionary solar PV mounting system for biodiverse or extensive green roofs. Well suited to new build applications where environmentally friendly solutions are required to meet planning and BREEAM requirements. Our BioSOLAR system can also be retrofitted on many existing roofs without the need for any structural modification to the building.

A key element is that the front edge of the PV panel is set 300mm above the level of the substrate, which allows liberal growing room for the vegetation without blocking light to the array that would otherwise reduce the efficiency of the panels. This height setting also enables light and moisture to reach beneath the panel to support the plants below.

See Chapter 11 for more indepth information

Vegetation Mats

Bauder's SB substrate sedum blanket or WB native wildflower blanket can be used to stabilise the substrate quickly in exposed locations and gives instant greening between panels. These are typically placed between rows only (not under the panels) with Bauder Flora 3 seed mix being used in these shadier areas.

Plug Planting

Plug plants are used in areas where particular species are required. Care is required to only specify species that do not grow higher than the panels.

Bauder Flora 3 Seed Mix

The Flora 3 seed mix has been specially designed to work with the Bauder BioSOLAR system and is a mix of low growing and shade tolerant species. The whole roof area can be of benefit to wildlife, taking advantage of the mixture of shade sun and shelter the BioSOLAR roof offers.

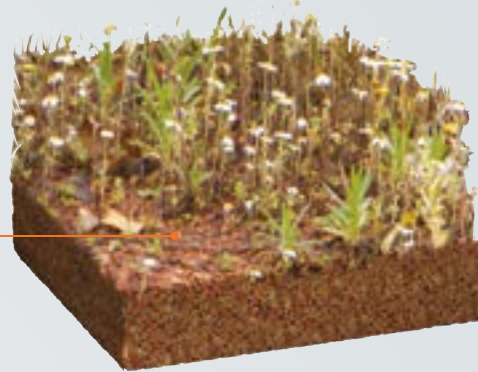

Seed Mix

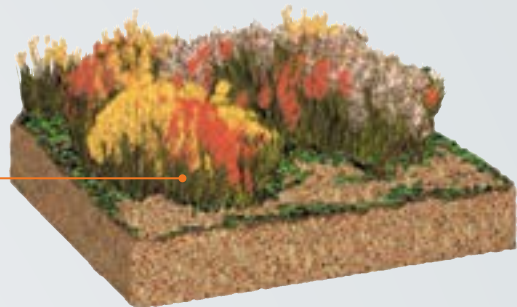

Plug Plants



Vegetation Mat

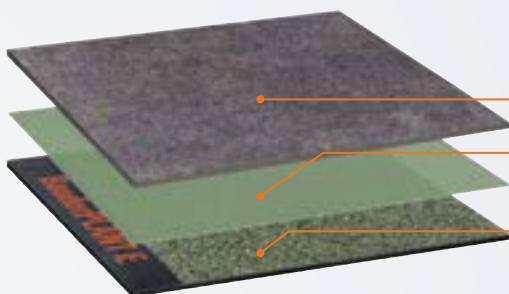

Bauder FSM600 Protection Mat

recycled polyester and polypropylene fibre mix.

Bauder PE Foil

polyethylene foil separation and slip layer manufactured from recycled granules.

Bauder Waterproofing

shown here with Plant E root resistant, SBS modified bitumen membrane reinforced with 250g/m² recycled spunbond polyester.



www.bauder.co.uk/technical-centre

PROJECT



GREEN ROOFS

LIGHTWEIGHT SEDUM SYSTEM

Extensive green roof XF301



ST LUKE'S CHURCH

Location: **Reigate, Surrey**

The new annex, featuring two barrel vault green roofs, was added to the west end of the original church building to provide a new entrance, two large meeting rooms, toilets and a kitchen. The revitalised church was opened to the community by the Bishop of Croydon.



This is the lightest weight all in one system available. It comprises mature sedum on 20mm of extensive substrate and incorporating a multifunctional water retention and filter layer. The system is suitable for both new build construction and retrofit refurbishment projects.

Our extensive XF301 Sedum System is constructed using low maintenance drought resistance planting (sedum species) that provide excellent cover and increased protection to the waterproofing system.

The plants are grown on a 'blanket' that is harvested like turf and installed by rolling out on top of the waterproofing. The blankets are very lightweight, easy to maintain and provide instant greening to the roof.

The XF301 sedum system is a very versatile green roof system and is suitable for both new build and refurbishment projects.

Key Features

- The most lightweight green roof system available, making it ideal for retrofitting or refurbishment projects.
- Delivers instant greening of a roof with mature sedum species.
- Ideal solution where a green roof needs to be specified to meet planning requirements.
- Ideal for projects where there are weight, height or cost constraints.
- Sedum blankets are grown on our farm in the UK and delivered to site within 24 hours of harvesting.
- Fire classification B_{ROOF} (t4) and verified by the BBA as 'unrestricted' and suitable for use on any part of a roof in conjunction with Bauder Total Green Roof System.



The system features up to 14 species of sedum together with some mosses and grasses which ensures plant diversity regardless of location; species are selected to suit our climate and keep weight and maintenance to a minimum.

All our green roof systems comply with GRO and FLL guidelines.

GREEN ROOFS

Specification Support

Specification downloads:
www.bauder.co.uk/technical-centre

Telephone helpline:
 0845 271 8800



LIGHTWEIGHT SEDUM SYSTEM

System Configuration

The multi-functional XF301 combines the vegetation support layer with a moisture retention fleece to provide the perfect base for all roofing scenarios with a labour efficient installation.

Our patented geo-textile carrier fleece with its ultraviolet resistant nylon loops provides a support base for the specially developed substrate growing medium and gives stability to the established vegetation whether on a flat roof or up to 25° degrees.

The integral fleece is a unique feature of our XF301 sedum system, retaining moisture after rainfall and thus allowing the plants to take up the water for future use. The sedums are grown to maturity before being harvested, thus ensuring that they acclimatise quickly to their new rooftop location.

We currently cultivate 60,000m² of XF301 and are able to harvest the sedum and deliver to site within 24 hours.

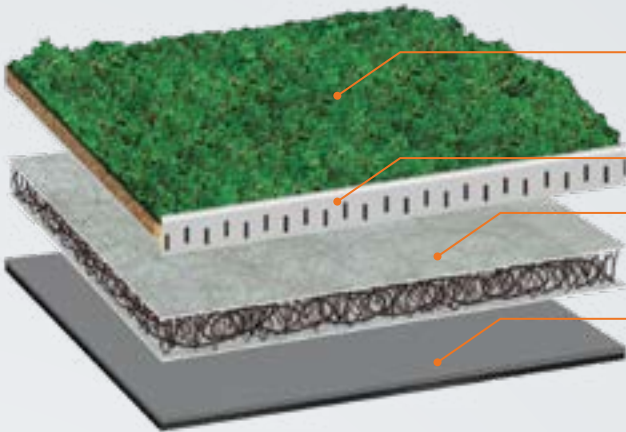

Bauder XF301 Sedum System

pre-cultivated vegetation blanket on a patented nylon loop and geo-textile base carrier with special substrate and a pre-attached integral 8mm moisture retention fleece.

AL40 Sedum Blanket Edge Trim

perforated edge/drainage trim.

Bauder SDF Mat

multifunctional drainage, filtration and protection layer manufactured from ultraviolet resistant nylon woven loops which are thermally bonded to geo-textile filter fleece facings.

Bauder Waterproofing (all four types are suitable)

System Installation



Long length rolls are used to speed up installation process.



Short 2m rolls of XF301 Sedum System installed by hand.

PROJECTS



Waitrose
Bagshot, Surrey



Cliff Hotel



Rings Farm
Holiday Cottages, Cupar, Fife

GREEN ROOFS

PROJECT STUDIES

Bauder's XF301 Sedum Blanket system



Lagg Distillery

Bauder's XF301 Sedum Blanket



Greenroof UK Ltd and Bauder were approached by Quantum Solutions and Denham Benn Architects to create a green roof system for the new distillery and visitors centre at Lagg, which is located at the southern tip of the Island of Arran just meters from the coast. The architect and client were keen that the roof scape would blend into the environment, but that the shape of the roof would reflect the distinctive hill scape of Arran as seen from the mainland.

The complex shape of the roof rose from 2.00 meters above ground level to 12.00 meters, the width varying from 16 meters to 40 meters with gradients ranging from 8 degrees to 31 degrees, all to create the look of a rolling hillside. In order to allow pattern for the introduction of restraint battens within the build-up which would carry the weight of the system over the slopes, a unique sedum restraint system had to be introduced to cope with the extreme prevailing winds from the coast.

The finished roof emulates the look of a rolling hillside and cuts an impressive view against the backdrop of the Firth of Clyde. Approved contractors Greenroof UK were recognised with the NFRC Scotland 2019 green roof award project trophy for their inspiring workmanship.

BUILDING BOARD

Client:	Quantum Solutions
Location:	Isle of Arran
Roof Area:	2,700m²
Architect:	Denham Benn Architects
Contractor:	Greenroof UK Ltd

APPLIED PRODUCTS

- Bauder's XF301 Sedum Blanket
- Plant E cap sheet
- KSA DUO Underlayer
- PIR FA-TE Insulation
- DS1 DUO Air and Vapour Control Layer

Biodiverse green roof



Sharrow Primary School

The Bauder green roof on Sharrow Primary School in Sheffield was the first in the country to be declared a nature reserve. A fitting accolade for a school that defies traditional ideas of what a school should be.

Restricted ground space opened up the opportunity to create green roofs at three levels for play space, and outdoor classrooms and a 2000m² biodiversity roof designed to replicate a meadow, complete with cornflowers and other urban plants. It is also a haven for birds and other kinds of wildlife, with rotting tree stumps provided for many kinds of insects. All of roofs are used as a learning resource with curriculum-friendly uses for all the children.

Sharrow Primary is also Sheffield's greenest school, with a heating system powered by warmth coming up from deep in the earth and toilets flushed by rainwater, further proving that Sharrow School is a real testament to what can be achieved and is a landmark construction that raises the benchmark. This sustainable building was delivered on time and within budget with ongoing whole life cost savings.

BUILDING BOARD

Project:	Sharrow Primary School
Investor:	Sheffield City Council
Place:	Sheffield
Area Size:	2000m²
Architect:	Sheffield City Council
Contractor:	Malden Roofing Contractors

Intensive green roof



Small Animal Hospital

Set within the Garscbue Estate, Archial Group, the Architect, wanted a new build project with as minimal visual impact as possible, so the building was constructed within the side of a hill with a green roof. Towards the end of the roof's construction a seeded grass finish was opted for.

Past experience proves that the open texture of traditional substrates can allow the seed to be blown off the roof and to migrate down into the growing medium to a point where it cannot germinate properly, creating a patchy finish. To prevent this, Bauder developed a specialist seed bed substrate mix to be used as a topdressing over their traditional intensive substrate, allowing the use of a grass seed mix that could easily blend with the surrounding grassland. The seeds were dressed onto this top-dressing using traditional sowing techniques and equipment, which delivered both optimum germination and the swift establishment of a healthy, even greensward.

The building seamlessly blends into its surroundings, inviting visitors to explore the roof top vantage.

BUILDING BOARD

Client:	University of Glasgow
Location:	Glasgow
Roof Area:	2,800m²
Architect:	Davis Duncan Architects
Contractor:	Advanced Roofing Systems

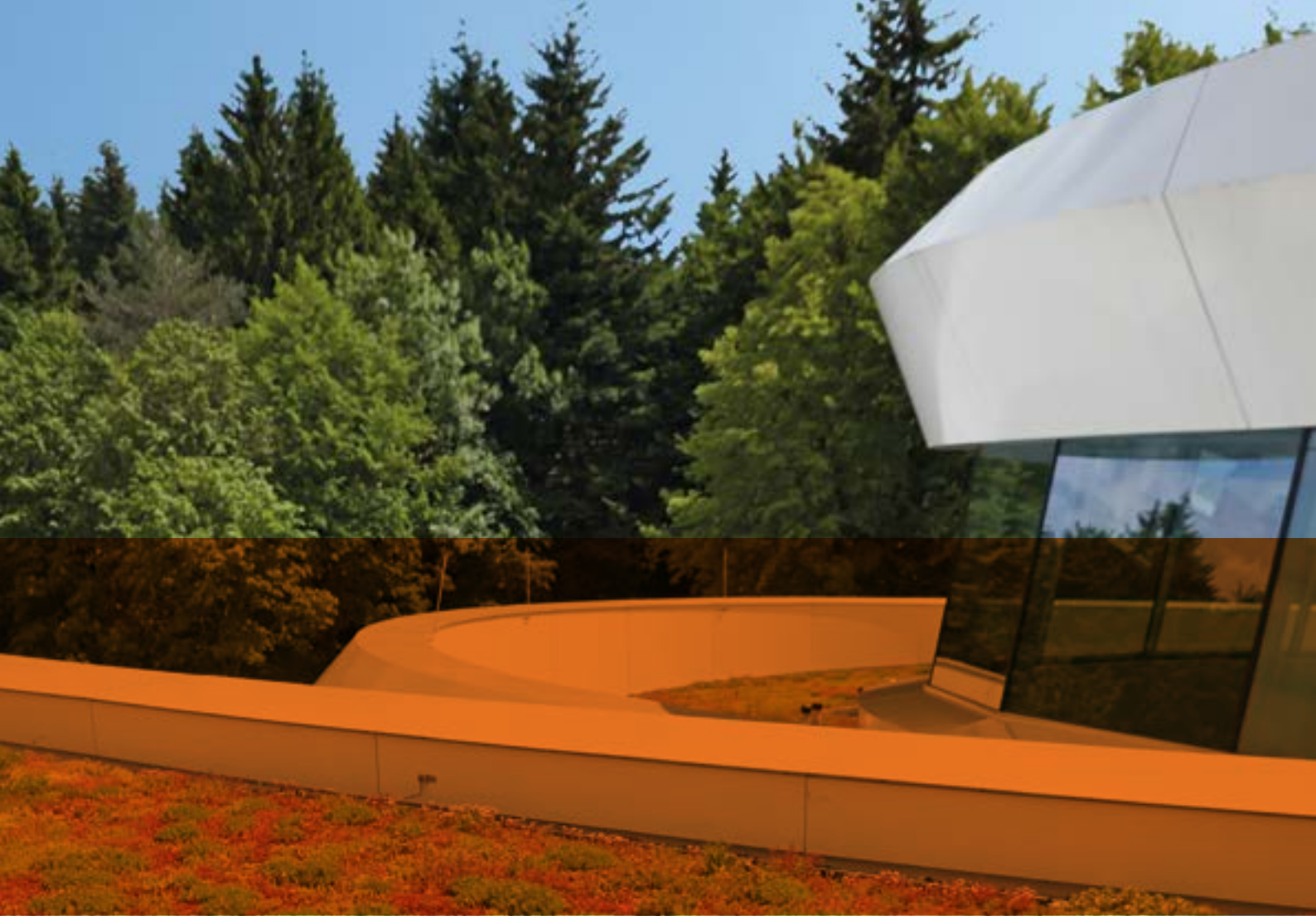

TECHNICAL DESIGN

Green Roofs



www.bauder.co.uk/technical-centre

■ Considerations	196
■ Weight Loadings	198
■ CAD Details	204
■ Vegetation	208
■ Biodiverse Landscapes	209
■ Substrates	210
■ Water Storage and Drainage	212
■ Protection Layers	217
■ Pedestal Support System	218
■ Irrigation	220
■ Service and Promise	221
■ Maintenance	222

GREEN ROOF DESIGN CONSIDERATIONS

Green roofs have now become big business and it is important that any supplier is able to prove their credibility and to offer valuable guarantees.

This section briefly explains items that need to be considered when designing a green roof.

We have a comprehensive Green Roof Design Considerations guide available to download from www.bauder.co.uk/technical-centre/design-guides

Why is a green roof required and what performance is expected?

There could be many reasons why a green roof is required. It may be to satisfy a planning constraint, in which case economic options will be considered; mitigate against storm water where the design will maximise rainwater attenuation; support specific wildlife for a biodiversity solution; provide recreational space with public access; offer additional energy savings or generation as photovoltaic units are up to 5% more efficient when used on a green roof; or for aesthetic reasons where the building needs to be masked into its surrounding environment.

Essential Factors to be Considered

The most important factor when considering a green roof is the strength and durability of the underlying waterproofing which must:

- Meet all waterproofing standards.
- Have an FLL Compliant Root Barrier.
- Be leak tested prior to installation of the green roof elements.
- Have drainage calculated to cope with severe storm events.
- Incorporate safe access to the roof for maintenance.
- The green roof should be designed to:
 - Balance with the environment and growing conditions on the roof.
 - Meet any planning requirements.
 - Work within the constraints of the building design (height, weight etc).
 - Be maintained safely.
 - Provide a mixture of different habitats for plants and insects.

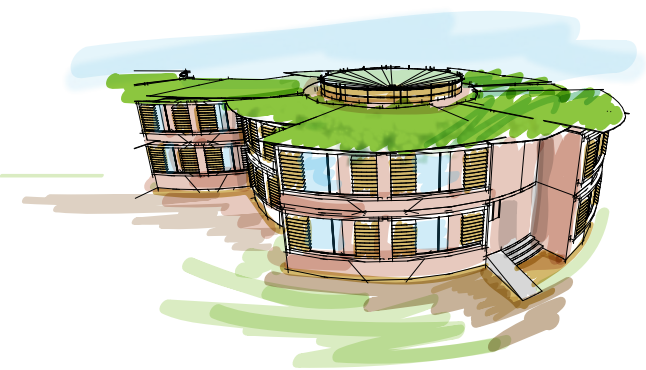

The Landscape Finish

The primary decision is the type of landscape required that best suits the rationale behind the development, whether it is an intensive, extensive or biodiversity roof. Whatever the landscape chosen, the plants will have some basic requirements to sustain them; nutrients, a balance between moisture and drainage to suit the vegetation, and aeration to the root system.



Structural Loading

Most roof deck constructions are suitable provided that they can support the imposed load. The saturated weight of the system should be determined at an early stage. Our technical team can provide information so relevant data can be passed to the client's structural engineer.

Indicative weight loadings:

- Intensive systems - 300-400Kg/m².
- Extensive substrate systems - 120-200Kg/m².
- Lightweight sedum system 44Kg/m².

Root Resistant Waterproofing System

All our waterproofing systems are suitable for green roofs, depending on the type specified.

Bituminous and single ply membranes have passed the stringent four year FLL root resistance test widely regarded as the toughest green roof performance trial currently available.

Falls

Intensive green roofs can be safely installed on horizontal decks whereas with extensive green roofs minimum falls of 1:60 and above are preferred. The criteria is to have a depth of drainage layer deep enough to hold the landscape above any residual standing water that occurs on the surface of the deck.

Drainage

The soft landscaping on a green roof will retain a large percentage of the average annual rainfall, as for example an intensive green roof can retain up to 90%, which will result in a significant reduction in the number of outlets required and will thus reduce costs.

All outlets should be protected by an inspection chamber with removable covers to allow access for maintenance, and be surrounded by a pebble vegetation barrier to prevent encroachment.

Growing Mediums

Usually referred to as substrates, they provide the necessary nutrients, aeration and anchorage for the plants. We blend a number of different substrates tailored to the vegetation being grown, they are FLL compliant, peat free, and weigh significantly less than top soil.

Vegetation Barriers

These provide important functions on a green roof:

- As required by FLL and GRO as a fire break.
- Provide rapid surface drainage during heavy rainfall.
- Reduce and ease routine maintenance.
- Protection of the waterproofing from mechanical damage during maintenance.
- Wind uplift resistance by increasing the imposed load at roof perimeters.

Pebble barriers should be provided at perimeters, abutments, rooflights, inspection chambers and all other protrusions. They are not suitable on roofs with a pitch greater than 9° where alternative materials are used.



Wind Uplift

The stability of the system is increased because the negative pressure forces that can develop during high wind conditions are counteracted by the weight of the green roof system.

Wind can also lead to erosion problems on exposed sites, especially if plant establishment is in the early stages.

Irrigation

Requirement for irrigation will depend upon the location of the building, the local climate and the type of plants used to vegetate the roof.

On our XF301 Sedum System, we recommend installing a leaky pipe irrigation system where the following conditions apply:

- South facing roof slopes exceeding 5° pitch.
- All roof slopes exceeding 10° pitch.
- Windy or exposed site locations.
- Inland sites where rainfall is less frequent.



On intensive green roofs an automated system is generally the best option and the frequency at which it is applied will depend on the plant species.

Safe Roof Access

Provision should always be made for safe access to the roof for routine maintenance, which may include man-safe systems with harness and attachment points, internal access hatches or an externally mounted bracket to secure a ladder.

Maintenance

All roofs require a minimum of two inspections a year to ensure that the outlets etc. are maintained. An extensive green roof will need only minimal maintenance to feed the vegetation and ensure that any unwanted species do not become established.

Intensive schemes will require more regular maintenance. download more information from the Technical Centre on our website, bauder.co.uk/technical-centre

Bauder Green Roof Maintenance Service

Our green roof maintenance service focuses primarily on extensive systems and is set up to be tailor made to suit the client's budget and type of extensive roof installed.

The Bauder Green Roof Promise

Our Green Roof Promise links with our Maintenance Agreement to ensure the continuous health of the Bauder supplied vegetation and that all aspects of the green roof remains healthy and established with the appropriate vegetation.

These documents are bound together and work in unison to give clients peace of mind, knowing that the entire green roof is in safe hands.

DESIGN & WEIGHT LOADINGS

XF301 Lightweight sedum system

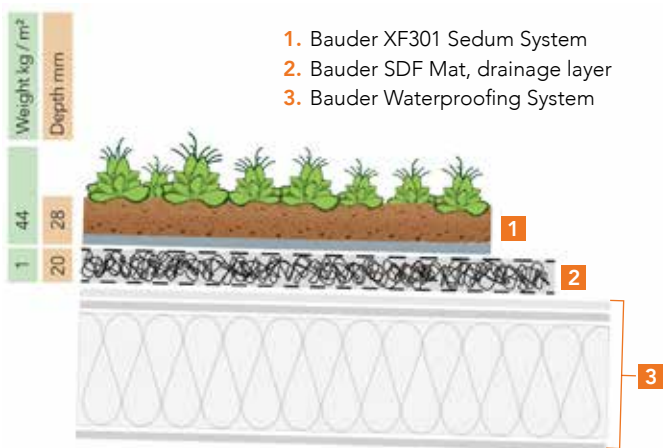

Flat Roofs

Extensive green roofs should be designed with a minimum fall of 1:60, and even then, small areas of standing water may still occur. This water will rot and kill the vegetation.

Bauder SDF Mat drainage layer is specified within the system to lift the blanket clear of any standing water, allowing it to disperse during periods of prolonged heavy rain. It is lightweight, weighing only 0.6Kg/m².

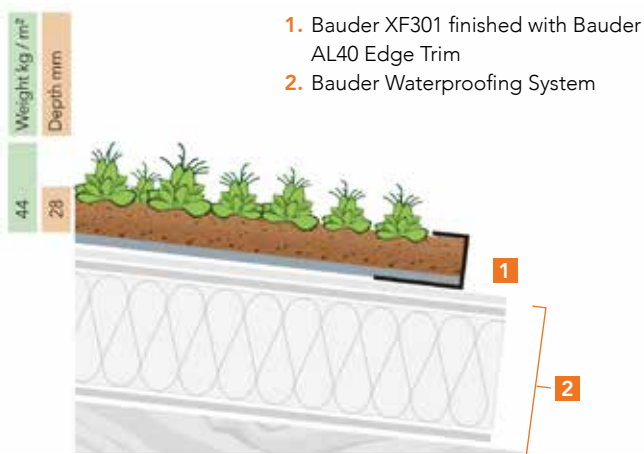

Roof slopes 2° and up to 9°

For roof slopes exceeding 2° standing water should not be an issue, allowing the SDF Mat drainage layer to be eliminated and the Bauder XF301 Sedum System installed directly over the waterproofing.

Standard 2 x 1m rolls can be used up to 5° but on larger roofs above this pitch, long rolls in lengths up to 10m reduce the number of joints and are more wind resistant. A crane that is capable of reaching all areas of the roof is imperative when using long rolls.

When installed over either a 'barrel vault or 'dual-pitched' roof, the long length blanket may be applied over the ridge as the forces imposed are counterbalanced. For all other situations, Bauder sedum blanket retention strip should be used.

In some instances it is not possible to use the long length roll, i.e. if there are numerous rooflights or interruptions or if crane access is impossible. In these situations the standard 2x1m lengths may be used in conjunction with the Sedum Blanket Retention Strips to mechanically prevent slippage of the blanket, (see facing page).



AL40 Sedum Blanket Edge Trim

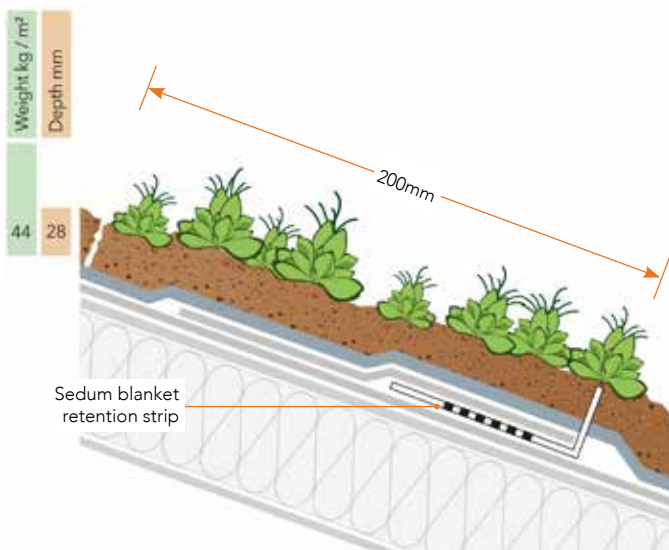

Roof slopes 10° and up to 25°

Where the XF301 blanket is to be installed on a pitch between 10° and 25°, it is essential to mechanically restrain the blanket against the shear forces created by the slope. This is achieved by using the Bauder Retention Strip.

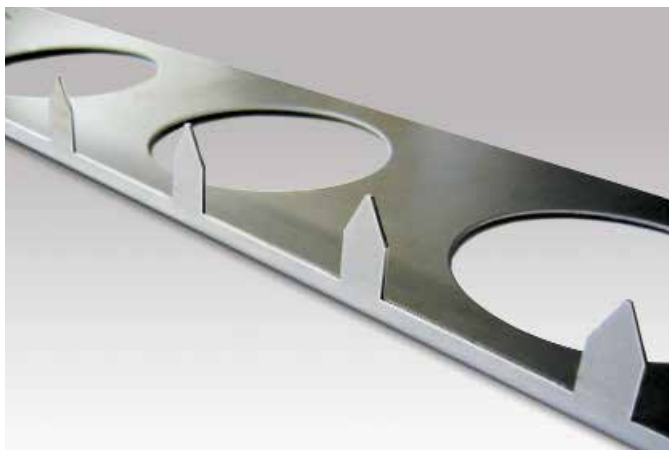

Sedum Blanket Retention Strip

Each retention strip is set in a staggered pattern 200mm below the leading edge of the blanket, the strip being secured by a 200mm wide strip of cap sheet which is bonded through the holes of the base plate of the strip to the waterproofing underneath. The teeth of the retention strip penetrate the underside of the blanket and ensure that no post-installation slippage occurs.



Roof Slopes > 25°

Sedum plants can thrive on slopes exceeding 25°, however, increasing the steepness of the roof slope above this will introduce issues in relation to building maintenance that must be taken into account within the design. It is very difficult to stand on a roof above this pitch without damaging the plants and fertiliser can be washed out of the blankets during heavy rainfall, necessitating additional applications.

Not all roof designs are suitable, should you be considering a green roof installation on an extreme slope we would suggest that you contact our green roof technical department in the first instance for guidance.

DESIGN & WEIGHT LOADINGS

Substrate green roof systems

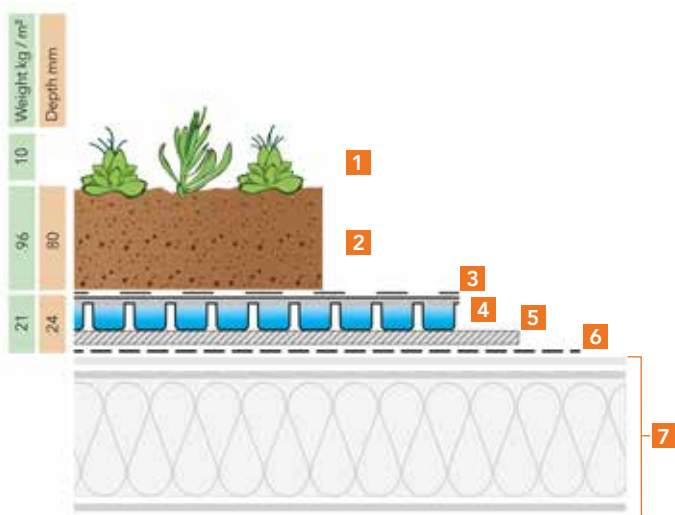

Sedum plug plants on extensive substrate with DSE20

A broad range of individual sedum plug plants can be used to produce a particular design or planting layout suited to the roof conditions. Plugs are typically planted 15-25 per m² and normally in groups of 5-7s of similar species. Sedum plants are very drought tolerant and DSE20 with 80mm of FLL compliant Bauder Extensive Substrate gives adequate water storage to support the vegetation.

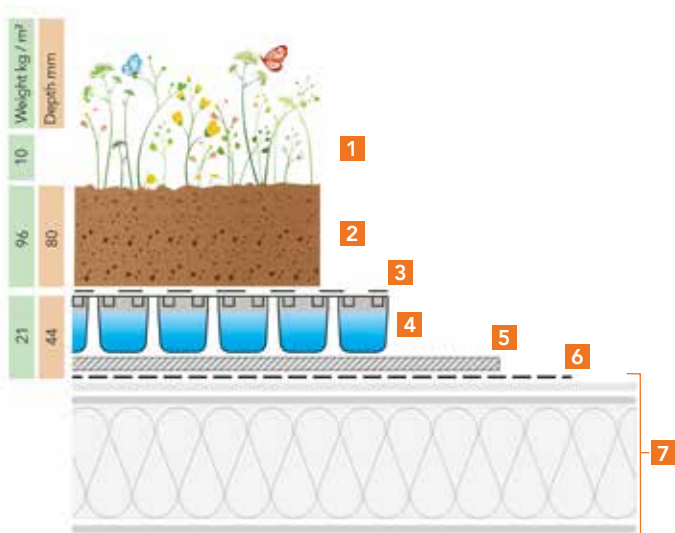

British native species vegetation on biodiverse substrate with DSE40

Often to ensure particular key species establish on a roof individual native species plug plants are used. The vegetation can be established either with a mix of plugs or seed or a combination of the two. When wildflower plugs are used substrate depth needs to be adequate to support the plants and water storage sufficient to maintain plant life. This is achieved with DSE40 water storage board and at least 100mm of substrate which conforms to FLL / GRO guidelines.

LEGEND

1. **Vegetation** to suit the project and site locality.
2. **Bauder Extensive or Biodiverse Substrate** Light weight growing medium. Manufactured and used in accordance with FLL / GRO guidelines.
3. **Bauder Filter Fleece** filtration layer prevents substrate fines from washing into the drainage layer.
4. **Bauder water storage and drainage DSE20 or DSE40**, capacity to suit the vegetation and project.
5. **Bauder FSM600** 4mm thick protection layer.
6. **Bauder PE Foil** A polyethylene foil separation and slip layer manufactured from recycled granules required on some project specifications.
7. **Bauder Waterproofing System** High performance waterproofing membranes suitable for green roof systems.

Substrate pitched roof systems

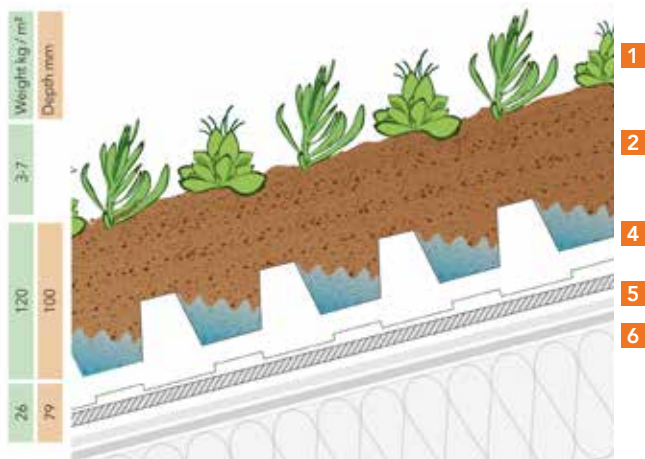

Slopes of 5 - 15°

On slopes above 5 degrees, a mechanical stop at the base of the green roof is required to prevent the system moving. Bauder 75mm Reservoir Board interlocks for greater stability and gives improved water storage on pitched roofs.

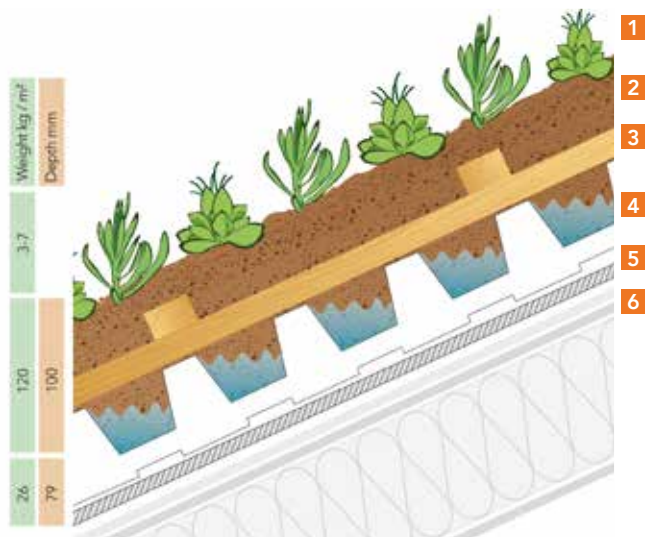

Slopes of 15° - 25°

On roof slopes above 15°, in addition to the mechanical stop, a trellis is added to the substrate to prevent it slipping whilst the plants become established. It is important that the root systems bed-in quickly to prevent erosion.

Early consideration of the design, construction method and ongoing maintenance of the green roof is vital if the roof is to be successful.

All pitched roof systems will require drip line irrigation to maintain the vegetation during dry weather.

LEGEND

1. **Vegetation** selected species to suit the project, site locality or BAP.
2. **Bauder Extensive or Biodiverse Substrate** lightweight growing medium, manufactured and used in accordance with FLL guidelines.
3. **Timber Trellis** fabricated from untreated timber for substrate retention.
4. **Bauder Reservoir Board** water storage and drainage, 75mm thick.
5. **Bauder FSM 600 Protection Mat** a 4mm thick protection layer.
6. **Bauder Waterproofing System** high performance waterproofing membranes suitable for green roof systems.

DESIGN & WEIGHT LOADINGS

Recreational spaces, gardens and terraces using DSE40 and DSE60

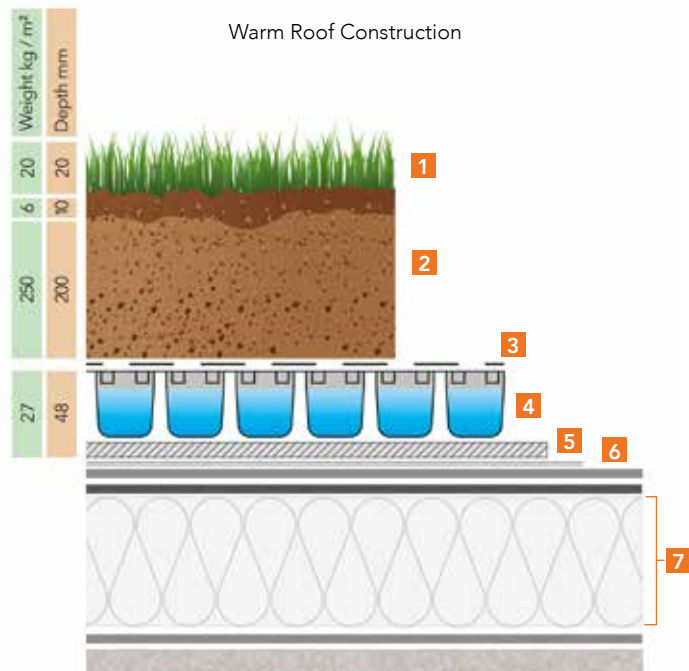

Turf finish

For a lawn finish, either real or artificial, it is important to correctly construct the base. The Bauder DSE40 board delivers stability whilst also ensuring adequate drainage and if required this product can be filled with Bauder Mineral drain, Type 1 or concrete to allow the constructions of paths or planter walls.

1. Turf

2. Bauder Intensive Substrate

Lightweight growing medium, 200mm.

3. Bauder Filter Fleece

Filtration layer prevents substrate fines from washing into the drainage layer.

4. Bauder DSE40

Water storage and drainage 40mm thick.

5. Bauder FSM1100 Protection Mat

Polyester and polypropylene fibre.

6. Bauder PE Foil

Polyethylene foil separation layer (required on some project specifications).

7. Bauder Waterproofing System

(Warm roof, Bauder Total Green Roof System shown)

Roadways and footpaths

In applications where roadways and footpaths are required, the board area immediately underneath can be infilled, to provide a stable base for construction capable of supporting heavy vehicular loads, to allow for uninterrupted drainage underneath the hard landscaping.



Recreational spaces, gardens and terraces with DSE 40 and DSE60

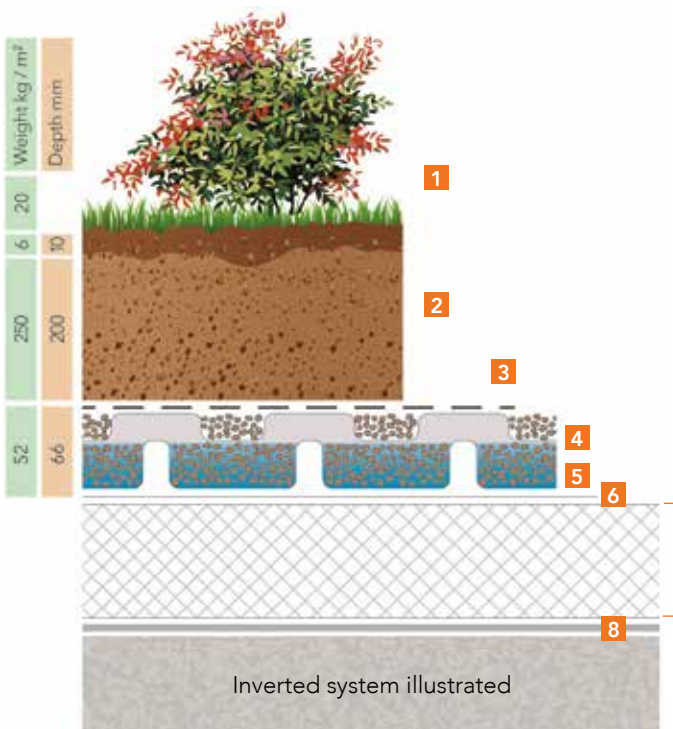

Soft and/or hard landscaping for heavy trafficking

Protection of the waterproof layers is vital where there is heavy traffic. The Bauder FSM1100 protection mat and DSE60 ensure there is no danger of mechanical damage to the waterproofing. DSE60 can then be filled with Bauder Mineral Drain or concrete to strengthen and spread the implied load.

1. Turf or vegetation

2. Bauder Intensive Substrate

Lightweight growing medium to support the planting scheme.

3. Bauder Filter Fleece

Filtration layer prevents substrate fines from washing into the drainage layer.

4. Bauder DSE60

Water storage and drainage 60mm thick.

5. Bauder FSM 1100 Protection Mat

6. Vapour Permeable Membrane

7. Bauder Inverted Insulation

8. Bauder Waterproofing System

(inverted hot melt shown)

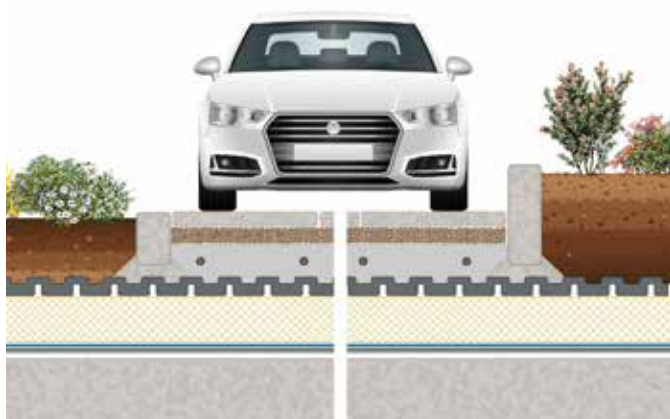

Access roads and support slabs

Many large modern developments incorporate planted central courtyards to utilise these valuable areas.

It is essential that a structural engineer assists you with specific information on loadings for your project. Bauder DSE40 and DSE60 is suitable for all walkways, driveways and road surfacing. Concrete covers over the upper board profile should be a minimum of 100mm. If you require an insulated system we will advise you on the depth of insulation necessary for your particular project. Bauder DSE40 and DSE60 will also provide a suitable base for constructing kerbs or foundations to support lightly loaded walls etc.

Bauder drainage boards are designed to support both hard and soft landscaping, laid in a continuous layer over the area to ensure there is free drainage.



GENERAL DETAILING

XF301 Lightweight sedum system

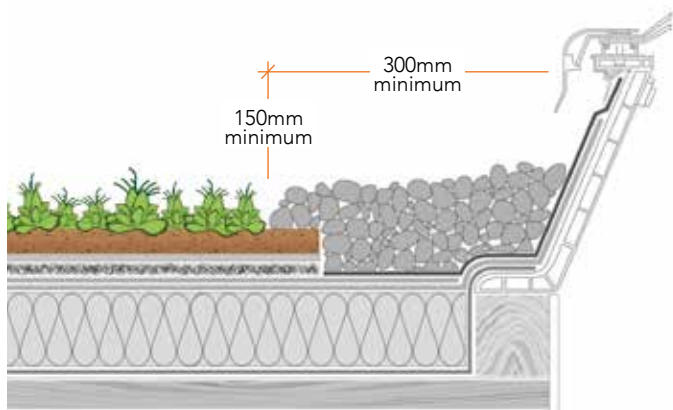

Construction to Rooflight Upstands

Detailing around upstands and rooflights is important and, to follow best practice, all Bauder green roof specifications follow FLL and GRO guidelines shown which include a pebble 300mm margin to act as a fire break. Where there are opening doors, windows or rooflights the pebble margin should be increased to 500mm.

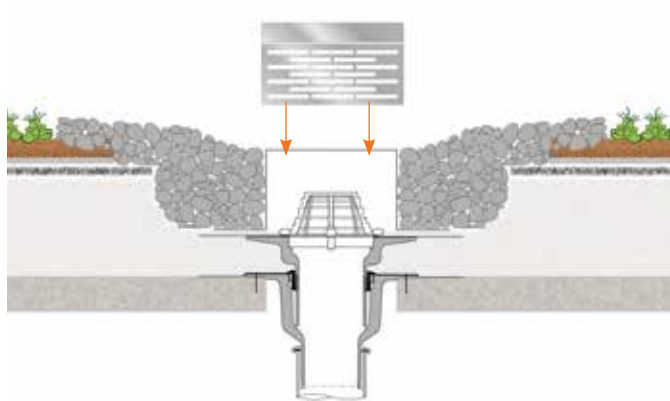

Bauder Inspection Chambers

These should be installed above all internal rainwater outlets to provide access for inspection and cleaning. The chamber lid is secured with a single quarter turn slot screw fixing and has finger holes for easy removal.

The base of the unit is slotted on all four sides to ensure effective drainage, has feet on three sides to provide a stable base onto the waterproofing and has a cut-away feature on the fourth side to allow for its installation at abutments to kerbs and upstands where either chutes or two way outlets are installed.

If required, the height of the chambers can be raised in 50mm increments by the use of extenders.

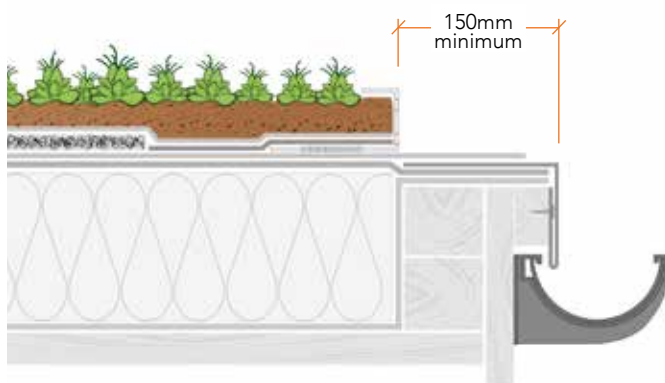

Bauder AL40 Sedum Blanket Edge Trim

This is a perforated marine grade aluminium alloy trim used to retain the sedum blanket at open perimeters with external gutters and is suitable for bitumen, single ply and cold liquid system installations. It is automatically used on specifications where the roof slope exceeds 5°.

This trim prevents substrate erosion at the exposed edges of the blanket and, due to the excellent wind uplift and fire characteristics of the Bauder XF301 Sedum System, may be used where a pebble vegetation barrier is impractical. The trim should be set back from the drip edge by approx 150mm to prevent vegetation overhanging the gutter and impeding drainage.

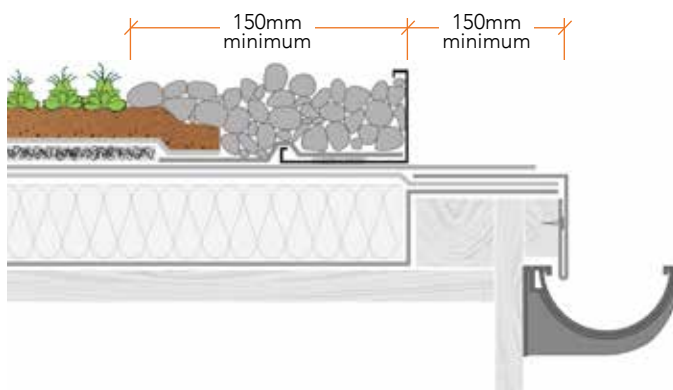

Bauder AL80/100 Drainage Trim

Perforated aluminium trim retains pebble vegetation barriers at open perimeters. The product is suitable for use with both bitumen and single ply waterproofing systems.

Substrate green roof systems

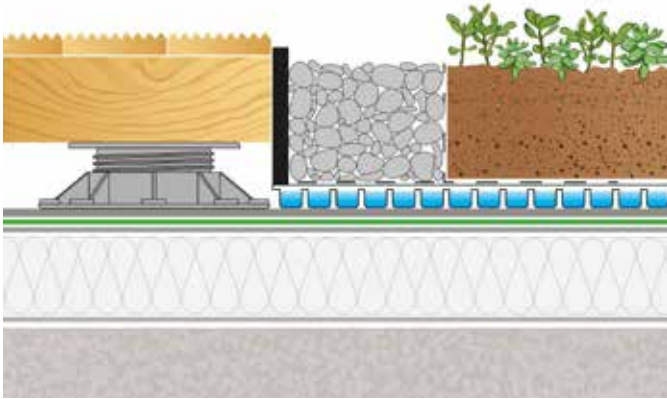

Timber Decking

Timber decking should be constructed with a slight fall to disperse rainwater. The timber framework should be raised off the roof surface so that water can flow freely to rainwater outlets and prevent the bearers from eventually rotting.

The suggested method is to place the decking framework on Bauder pedestal support units.

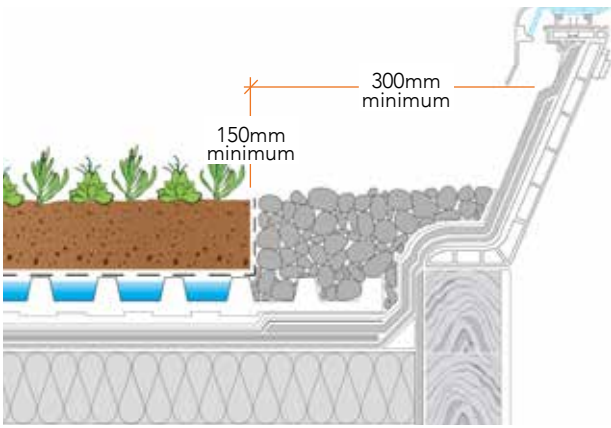

Rooflight Upstand

Due to the combined depth of the waterproofing system and soft landscaping, the proprietary kerbs supplied with most standard rooflights may be insufficient in height.

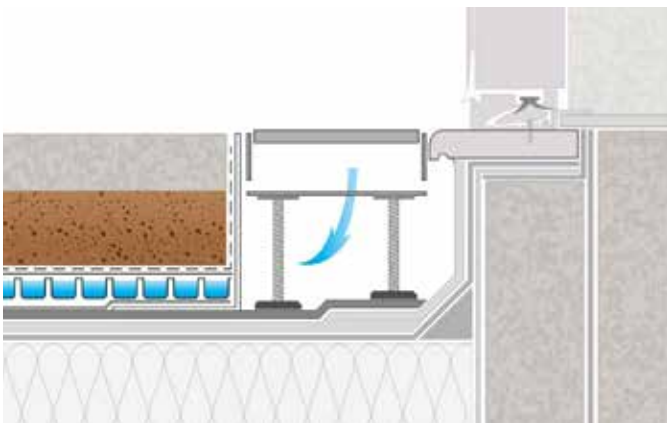

Bauder Linear Drainage System

For drainage close to walls or beneath door thresholds, linear drains can be used to collect surface water and discharge it directly into the drainage layer. The channel sections are perforated to allow water to seep through, and in the event of heavy rain, can direct water to outlets or drainage channels. The channel can be supplied separately for bedding on Bauder Mineral Drain (landscape depths exceeding 90 mm) or with adjustable support legs for depths of between 60 - 140mm. Stainless steel channel connectors and stop ends are also available for this unit.

GENERAL DETAILING

Recreational spaces, gardens and terraces

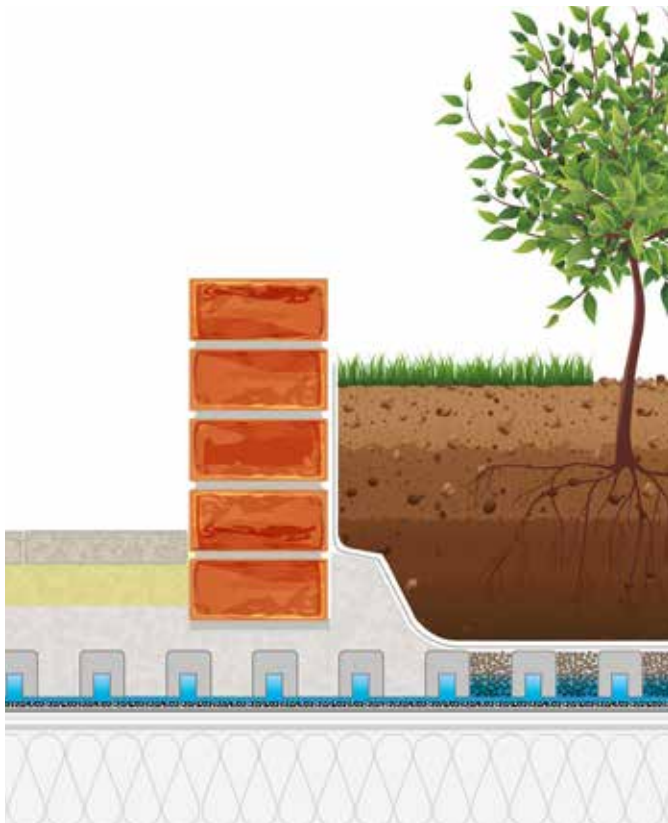

Raised Planter Beds

There are many different methods for constructing raised planter beds that are independent of the waterproofing system. However, they are all similar in that excess water must be free to drain away from the base to the nearest rainwater outlet.

To prevent staining, the inside of the planter should be waterproofed.

Wherever possible, we recommend that the waterproofing is applied to the whole roof surface to eliminate the need for complex detailing around structures built off the deck.



Perimeter Handrail

Intensive green roofs are predominantly used as recreational areas and therefore it is necessary to incorporate suitable perimeter protection within the design to meet current Health and Safety requirements.

Handrail systems should wherever possible be designed so that they do not penetrate the waterproofing system.

Where there is no practical alternative to a deck fixed handrail, it is important to ensure that the balustrade is circular to allow the waterproofing to be dressed and has an 'umbrella' cover welded to the stanchion positioned a minimum of 150mm above the finished height of the landscaping.

Recreational spaces, gardens and terraces

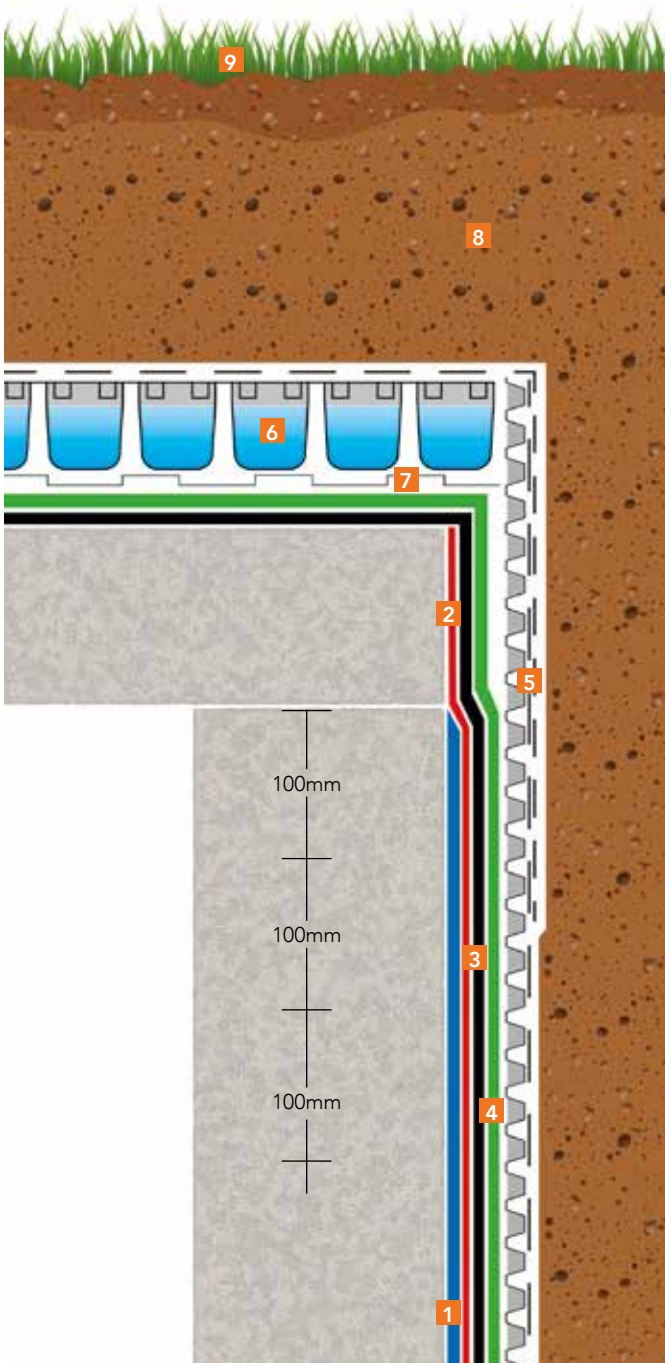

Join-On to Tanking

In situations where the Bauder waterproofing has to join to a structural tanking system, it is important to first establish that the proposed systems are fully compatible.

There are various proprietary tanking systems available on the market and our system is generally compatible with those that are bituminous based.

The illustration shows a typical example of the join-on detail to a Bauder Hot Melt System, in this instance the building is insulated internally. Bauder PLT10 to provide vertical drainage to a land drain at the base of the slab (not shown).

1. Bituminous Tanking (by others).
2. Min 500mm wide strip of Bauder KSA DUO Self Adhesive Membrane.
3. Bauder Bakor 790-11.
4. Protection layer, shown here as AP2
5. Bauder PLT10 (providing vertical drainage).
6. DSE40.
7. Bauder Filter Fleece.
8. Top Soil.
9. Turf.

Specification Support



Specification downloads:
www.bauder.co.uk/technical-centre



Telephone helpline:
0845 271 8800

BAUDER PLANTING & VEGETATION



Bauder WB Native Wildflower Blanket

The vegetation blanket meets GRO recommendations and is specifically designed to flourish in the difficult conditions found on roofs.

The blend of 38 British native wildflowers, herbs and grasses, that are included on most BAP lists, are sown on a 100% natural biodegradable coir blanket.



Bauder SB Sedum Blanket and XF301 Sedum System

Both of these vegetation blankets provide dense sedum foliage cover featuring up to 14 species of sedum.

The plants provide colour and are selected to suit our climate. The blankets are grown for 12 months. The Bauder SB Sedum Blanket is grown on a 100% biodegradable coir carrier and provides 90% ground coverage at installation.



Plug Planting

The use of small seedling plants have a number of advantages, each individual species can be chosen and the location and density of the planting can be controlled.

We can supply a wide range of British provenance plug plant species for a project.



Seeding

Seeding is a proven way to establish vegetation, however at roof level, the environment makes this a challenge without the correct provisions. We supply a range of British and Scottish provenance seed mixes which have a unique blend of seed species, adhesive to bind the seed to the substrate, organic fertiliser for nutrients and mycorrhizal fungi to increase the root surface area and establish the plants as they grow.

BIODIVERSE LANDSCAPES

These have been referred to, in the past as 'brown' or 'naturalised' roofs, and now come under the Biodiverse heading. Over the last few years there has been a dramatic growth in the requirement for biodiversity at roof level.

The issues are complex with each Local Authority producing their own Biodiversity Action Plan (BAP) and target species ensuring it complies with the ecological requirements to achieve maximum BREEAM credits and fulfils all the planning requirements.

Our technical team can produce comprehensive specifications for the roof and, if required, detailed roof plans and management plans.

Biodiverse Roof Plans

In discussions with architects, we can interpret the ecological requirements to show detail 'layout' drawings for the mounding of substrate and location of planting and surface finishes, ensuring the loading of the roof is compatible with the roof structure.



Biodiverse Green Roof Management Plans

Increasingly, local authorities require 3-5 year site specific management plans to ensure the roof establishes correctly and produces the habitat it was designed to deliver.

A further service offered by us is the Project Specific Management Plan. This enables the planning requirements to be discharged with our maintenance and monitoring team carrying out the work.

Vegetation

All BAP's are focused on the enhancement of the local ecosystems, to this end the provenance and suitability of the plant stock is key.

Our vegetation blankets are grown in the UK and all wildflower plugs are of British provenance.

Our Flora Seed Mix range uses seed from sources that are signatures to the Flora Locale code of practice. The seed mixes have been developed to offer suitable solutions for the variety of roof environments. They balance the requirement to have grasses and low ground cover to bind the substrate to prevent erosion with wildflowers to offer a nectar source to the many insects that inhabit biodiverse roofs.

Bauder Flora Seed Mix Range

Bauder Flora 3: General Purpose Mix

Broad range of species, generally low growing, including shade tolerant plants. Particularly suited for the BioSOLAR green roof system.

Bauder Flora 5: Urban Seed Mix

Specifically designed for city rooftops, there is a high percentage of annuals to give good colour in the first year.

Bauder Flora 7: Chalk Grassland

This mix has species particularly found on chalk soils, annuals are not included as they are not generally found on chalk grassland.

Bauder Flora 9: Coastal Mix

Designed for the harsh and saline conditions typically found around the coast of Britain.

Bauder Flora 11: Scottish Mix

The mix contains wildflower and grass species particularly suited to the Scottish environment. All the seed is of Scottish provenance.



WB NATIVE WILDFLOWER BLANKET

Supply Form	Thickness (Nominal)	Coverage	Saturated Weight	Size
Roll	30-35mm	2m ²	≥30 kg/m ²	1x2m

SUBSTRATES

For intensive green roofs



Mineral Drain

This single size limestone aggregate provides drainage for an intensive green roof system. It is typically specified alongside our DSE40 and DSE60 board as an infill to provide additional support, particularly when hard landscaping and further construction such as roadways and raised planter beds is to take place above the drainage layer. The mineral drain increases the compressive strength of DSE60 to withstand $\geq 1000\text{kN/m}^2$.



Intensive Substrate

Lightweight growing medium for intensive green roof planting schemes manufactured to FLL and GRO guidelines and comprises recycled crushed brick and expanded clay shale as well as organic content from composted pine bark. This formulation prevents compaction of soil which is common in topsoil applications. Intensive substrate weighs 1.25 tonnes per cubic metre compared to the average of 1.7 tonnes/ m^3 for top soil. A considerable weight load saving over an entire roof area.



For extensive green roofs



Extensive Substrate

Lightweight growing medium for extensive green roofs with sedum based planting schemes. Manufactured to FLL and GRO guidelines and comprises recycled crushed brick, expanded clay shale and composted organic material. Extensive substrate weighs 1.2 tonnes per cubic metre.



Biodiverse Substrate

Lightweight growing medium for biodiverse, wildflower and native species green roofs manufactured to FLL and GRO guidelines and comprises recycled crushed brick, expanded clay shale and composted organic material made from over 90% recycled content. Extensive substrate provides aeration qualities with some inherent water retention and weighs 1.2 tonnes per cubic metre.



Seed Bed Substrate

This substrate is a top dressing growing medium which is installed at a minimum depth of 25mm over either Bauder Intensive or Extensive Substrates, when the roof is to be either seeded or to receive vegetation cuttings. This substrate is made from recycled crushed brick and composted pine bark.

WATER STORAGE AND DRAINAGE

DSE60 for intensive green roof finishes

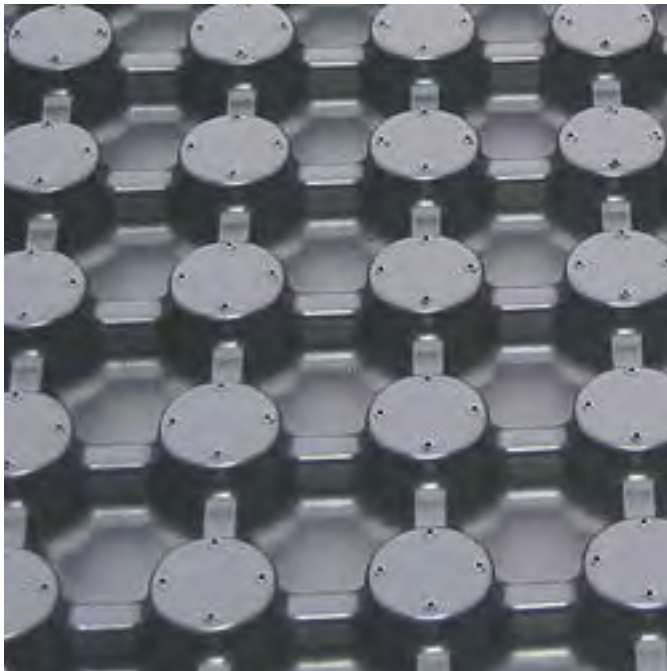

DSE60 is a multi functional product. Manufactured from recycled high density polyethylene (HDPE).

A deeply recessed surface profile provides water storage above and multi-directional drainage beneath. The large contact areas to the underside provide resistance to high loads and protect the waterproofing from point loading damage. The channels created beneath the board profile deliver high capacity drainage, whilst the upper profile, even when filled with our Mineral Drain, can store between 10 – 12 litres/m² of water.

Application

Our deepest and most robust drainage layer used under intensive landscaping and beneath paths or roadways.



Material	Recycled HDPE	
Board size	1m x 2m	
Thickness	60mm	
Weight	ca. 40 kg/m ²	When filled with Bauder Mineral Drain
Volume of board profile	ca. 33 litres/m ²	
Water storage	ca. 10 - 12 litres/m ²	
Compressive strength (unfilled)	ca. 100 kN/m ²	



DSE40 for intensive and extensive green roof finishes



DSE40 is a medium depth board which can provide multidirectional drainage beneath hard or soft landscaping. Manufactured from recycled high density polyethylene (HDPE), the board has been specifically developed to provide a high water retention capacity. It can be used continuously under a multitude of different landscape finishes.

Application

Designed for wildflower and biodiverse applications, as well as deeper, intensive landscapes. Its impressive water storage capacity of 13.5ltr/m² makes it possible to use shallower substrate depths.

DSE40 has the option to fill the cells with type1 or concrete to increase its strength for pathways, dwarf walls etc.



Material	Recycled HDPE
Board size	1.04m x 2.03m
Thickness	40mm
Weight	ca. 1.8 kg/m ²
Water storage capacity	ca. 13.5 litres/m ²
Compressive strength	100 kN/m ²



WATER STORAGE AND DRAINAGE

DSE20 for intensive and extensive green roof finishes



DSE20 is manufactured from recycled high density polyethylene (HDPE) where the cupped profile provides water storage whilst allowing the water to drain through the channels to the underside. It is primarily used to provide continuous drainage within landscaping situations where the loading is moderate.

Application

DSE20 is a lightweight, low profile drainage layer giving excellent drainage and some water storage capacity for sedum green roof systems. Its lightweight, thin profile makes it highly effective on roofs with minimal ponding.



Material	Recycled HDPE
Board size	1.06m x 2.3m
Thickness	20mm
Weight	ca. 1.2kg/m ²
Water storage capacity	ca. 7.4 litres/m ²
Compressive strength	ca. 110kN/m ²



Reservoir Board for sloped extensive green roofs



Our Reservoir Board offers the maximum water retention under flat, soft landscaping and is now most commonly utilised where roof slopes are in excess of 10°. The unique surface profile retains the Bauder substrate when the board is used on roof slopes.

Constructed from rigid expanded polystyrene foam with a profile that is lightweight, the board provides good water retention and allows multi directional drainage. It allows the substrate to be packed into the profile, thus reducing the shear load on the slopes.

Application

Used for all green roof build ups on slopes over 10°. The interlocking polystyrene board give a ridged surface to hold substrate in place on pitches up to 25°. Reservoir boards can be used with sedum, biodiverse, wildflower and intensive green roof build ups.



Material	Expanded polystyrene
Board size	0.780m x 1.283m (rebated)
Thickness	75mm
Weight	ca. 0.95 kg/m ²
Water storage capacity	21.5 litres/m ² (when laid flat)
Compressive strength	35 kN/m ²



WATER DRAINAGE

SDF Mat for extensive green roof finishes

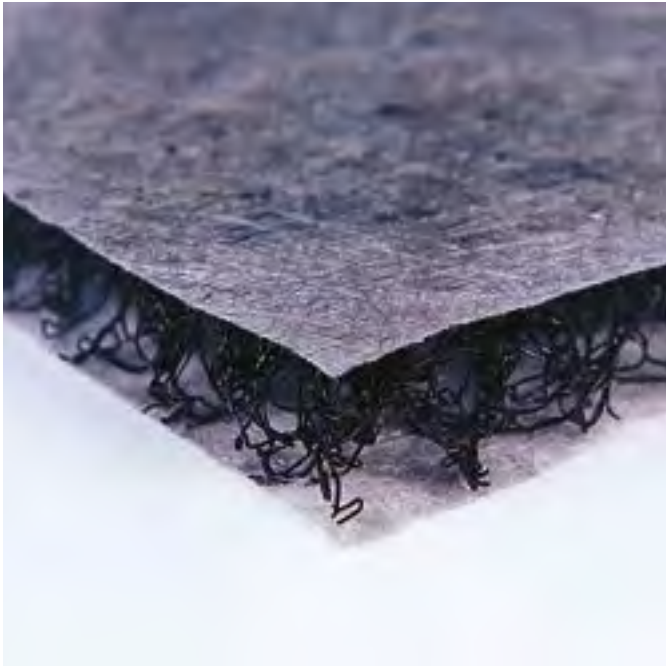

SDF Mat is a multifunctional drainage/filtration layer which also provides protection to the waterproofing system. The product is manufactured from ultraviolet resistant nylon woven loops which are thermally bonded to geo-textile filter fleece facings.

On larger projects with modest falls and where maintenance only foot traffic is anticipated, the SDF Mat offers a very cost-effective solution for lightweight extensive green roof construction.

Application

Our lightest drainage layer, SDF mat has no water storage capacity and therefore has a saturated weight of only 0.6Kg/m². It is primarily designed to lift Bauder's XF301 sedum system out of any standing water.



Material	Geo-textile facings with UV resistant woven nylon loops
Roll size	1m x 50m
Coverage	50m ²
Thickness	20mm
Weight	ca. 600g/m ²
Pressure resistance	ca. 20kN/m ²



PROTECTION LAYERS

For intensive and extensive green roofs



Pro-Mat

6mm heavy duty protection mat used within an intensive green roof to prevent mechanical damage to the waterproofing system. The product is manufactured from recycled shredded tyres.



FSM 1100

8mm substantial protection mat used within an intensive green roof to prevent mechanical damage to the waterproofing system. The product is manufactured from recycled polyester and polypropylene fibre mix.



FSM 600

4mm protection mat used within an extensive green roof to prevent mechanical damage to the waterproofing system. The product is manufactured from recycled polyester and polypropylene fibre mix.

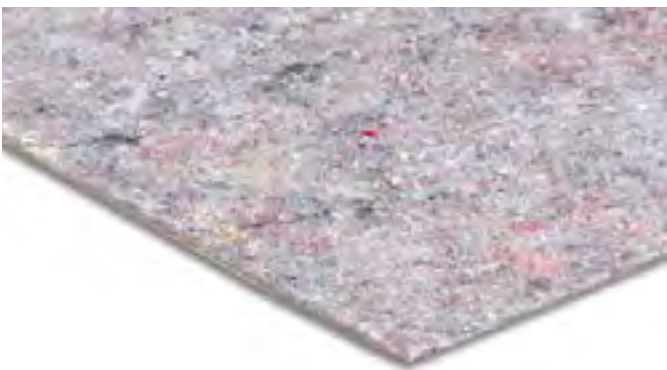

Eco Mat

6mm lightweight protection fleece used within an extensive green roof to prevent mechanical damage to the waterproofing system. The product is manufactured from recycled polyester and polypropylene fibre mix.

PEDESTAL SUPPORT SYSTEM

Adjustable Pedestals for all Types of Terraces and Decking Areas

Our pedestal support system is a range of lightweight, durable paving and decking support units, designed to meet the most exacting standards of both finish and level demanded by architects and clients when specifying open-jointed paving and decking finishes. The range of units, which are adjustable in height from 17-850mm and incorporate slope corrector heads that are variable to a maximum of 5%, are manufactured from black, UV-resistant high density polypropylene. A range of head attachments allow the gaps between pavers to vary between 2-10mm and there is also a joist batten holder available to secure the bearers for timber decking systems.

Advantages

- Eliminates algae and efflorescence.
- No bedding sand required.
- Quick to install.
- Cost-effective.
- Lightweight.
- Reduces sound transmission .
- Improves heat insulation.

Key Features

- A lightweight, heavy duty telescopic pedestal.
- Integrated slope corrector head.
- Suitable for a wide range of landscaping applications.
- Works with paving, decking and grillage.
- Allows easy access to concealed services and waterproofing.
- Supports loads of up to 1,000Kg per pedestal.

Slabs

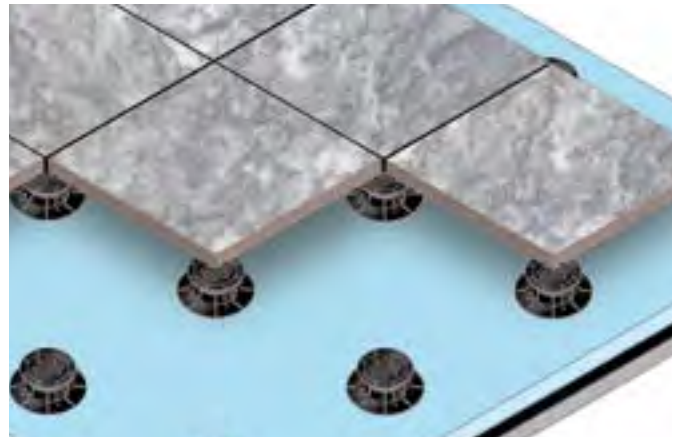

The most common use for the units is to support concrete and stone paving slabs. Where the longest edge of a slab is greater than 450mm, an additional pedestal is usually required under the centre of each slab.

Timber Deck Boards



The number of pedestals required is determined by the span of the joists used, and can only be calculated once the live load requirements are established. Please call us if you wish to discuss this further.

PH5 Slope Corrector

Compensates for a slope from 0 to 5% (slope from 0 to 5cm per linear metre). For good water run-off on roofs the slope should be around 2%.

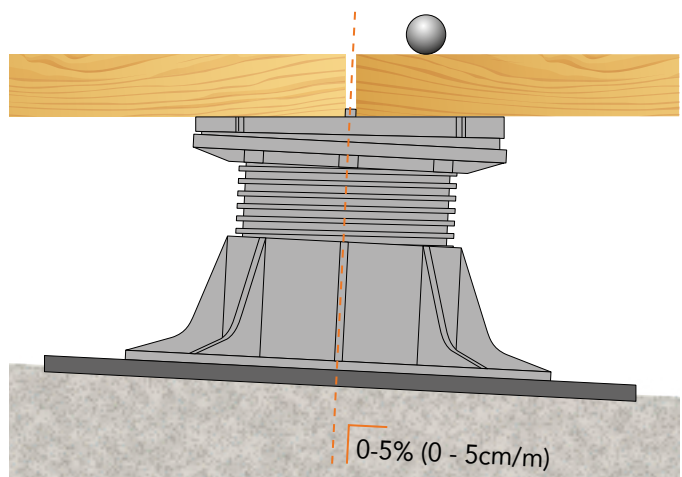

Specification Support



Specification downloads:
www.bauder.co.uk/technical-centre



Telephone helpline:
0845 271 8800

Standard Pedestal from 17mm x 170mm

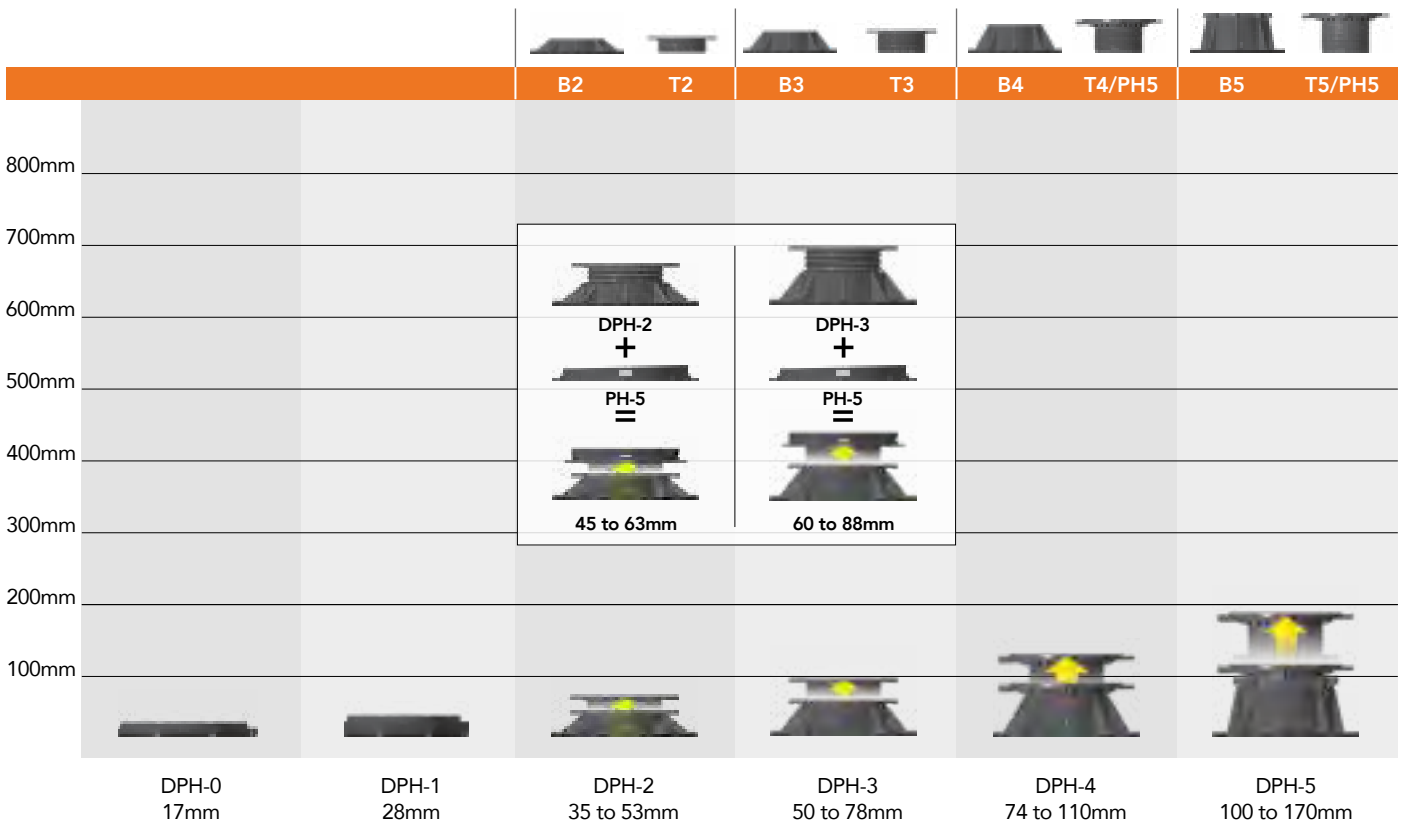

Standard Pedestal from 170mm x 850mm (with coupler C3)

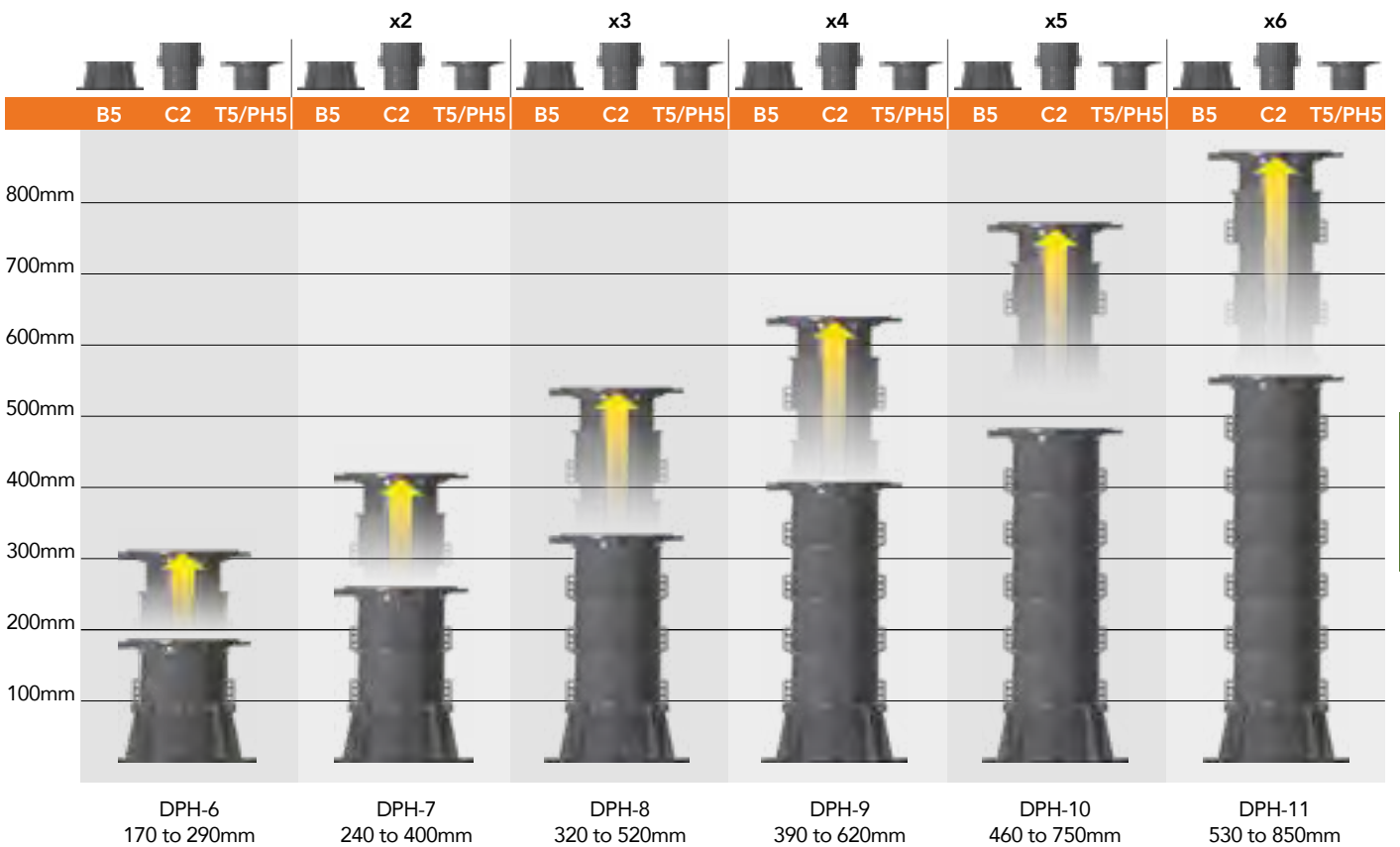

TECHNICAL DESIGN

IRRIGATION



Green roofs are an expensive finish for a roof so it makes sense to always design in a way to prevent the landscape from dying out in periods of drought. Irrigation should never be disregarded or excluded, because without it, the plants will find it very difficult to survive for the long-term in a healthy condition.

Although water is retained in the growing medium and water storage products this only serves to reduce the frequency of irrigation, particularly if the growing medium is shallow.

Automated irrigation is generally the best option in the long-term. There are many different types of irrigation available, ranging from fully automated with pop-up sprinklers to simple leaky pipe systems.



On the whole, the type of irrigation and frequency of application will depend on the plant species requirements and the prevailing weather conditions. Therefore, the system selected should follow the recommendations of the appointed landscape architect or nominated horticultural specialist and be installed strictly in accordance with the manufacturers recommendations.



▲ An example of a wall mounted control box used in conjunction with an automated irrigation system



OUR SERVICE AND PROMISE

Specifying a Bauder Green Roof System

Specifying Bauder materials for your project could not be easier. Simply contact your local technical manager or our technical department with details of your project and leave the rest to us.

- Design advice on waterproofing, planting and landscaping.
- Information on saturated loadings.
- Advice on drainage related issues.
- Thermal calculations.
- Condensation risk analysis.
- Detailed CAD drawings.
- Comprehensive project specifications.

Important

If you do specify our materials without seeking our advice, it is important that we are advised in order for your project to be eligible for guarantee.

Bauder is committed to ensuring our green roofs deliver as expected and by using our knowledge and experience of how green roofs perform best, we offer distinct levels of guarantee, assurance and support.

Our commitment to clients comprises:

Bauder Green Roof Maintenance Agreement - Keeping plants healthy and established on extensive green roofs.
Bauder Green Roof Promise - Safeguarding Bauder's planted vegetation.

Bauder Landscape Component Guarantee - Guarantees the non-living products specified to construct the green roof.

Bauder Waterproofing Guarantee - Covering the design, products and workmanship depending on the specified Bauder waterproofing system installed.

The Bauder Green Roof Promise

Our Green Roof Promise links with our Maintenance Agreement to ensure the continuous health of the Bauder supplied vegetation and that all aspects of the green roof remains healthy and established with the appropriate vegetation.

These documents are bound together and work in unison to give clients peace of mind, knowing that the entire green roof is in safe hands.

For a green roof to be eligible for the Promise, a Bauder Green Roof Maintenance Agreement must be in place as the green roof is a living ecosystem and as such is dependent on the aftercare the roof receives. The maintenance agreement requires levels of commitment by both the client and Bauder and these are detailed in the specific Bauder Green Roof Maintenance Plan provided within the agreement.

Working together in partnership to give confidence and certainty

The most effective maintenance regime is a partnership between the client 'on site' and Bauder's expertise to establish and nurture the roof. This partnership gives the client and other stakeholders (Local Authorities, Environmental Bodies, etc) the confidence that there is

a comprehensive management plan in place for the roof ensuring it remains at its best for the duration of the maintenance cover.

Duration of the Promise

The Bauder Green Roof Promise will (subject to a continuous Bauder Green Roof Maintenance Agreement) match the duration of the guarantee for the underlying waterproofing system.

Technical Services

At Bauder, we pride ourselves on our service package. Through our national team of technical managers and highly trained technicians, we can provide for all your likely requirements, from initial design advice on waterproofing or landscaping related issues through to a detailed and comprehensive specification package supplied in National Building Specification (NBS) or BIM format.

We are increasingly being asked by our clients to assist their consultants with the development of ecological roof systems to meet a Biodiversity Action Plan required for planning consent or where BREEAM points are required.

Whatever your requirement may be for a green or biodiverse roof landscape we will be able to assist you from the conceptual stage in developing a practical solution which will be cost-effective whilst also delivering long-term performance.

Approved Contractors

The quality and experience of the installation operative is essential to ensuring a successful project. We have always operated a policy where we train and approve the individual installer and not just the company they work for. By taking installers with proven experience and demonstrating the techniques particular to our system we can ensure a quality of workmanship that meets our client's expectations.

With our green roof systems, each installer is required to have a good level of knowledge and understanding of the products and systems that we supply and will regularly deal with our drainage and moisture retention layers, growing mediums and hard and soft landscaping.



On-site Support

Inspections are carried out at key stages of the contract by our own site technicians to satisfy the requirements of our insurance backed company guarantee on our waterproofing systems and ensure adherence to the specification for the landscaping.

ANNUAL MAINTENANCE

A green roof is a real asset to a building and for it to continue to deliver the environmental and aesthetic benefits for which it was originally designed, it is important to carry out maintenance on a regular basis.

A well maintained green roof will:

- Look at its best and ensure the optimum range of species for maximum coverage and longer flowering periods.
- Sustain healthy plant growth to provide a habitat for wildlife.
- Improve air quality by reducing airborne dust and help local air cooling.
- Offer protection to the waterproofing beneath.
- Help conserve and control rainwater runoff.
- Maximise the building's asset value.



Common Problems

Lack of Nutrients can lead to unhealthy plants and loss of vegetation coverage, resulting in bare patches and a reduction in the variety of species present.

Invasive Plants or Weeds, Fallen Leaves and Debris can spoil the aesthetic appearance and function of your green roof, and in some circumstances can even damage the waterproofing. The removal of leaf litter from overhanging trees and other accumulated debris is essential to prevent plants from being suffocated.

Impeded Drainage can be detrimental to plant health and roof performance. For example, when the growing medium is not free-draining it can become wet and lead to root rot or invasive grasses and weeds. Regular maintenance and inspection checks ensure that the outlets and areas surrounding outlet inspection chambers remain clear and perform as intended.



Health & Safety Considerations

Following health and safety best practice is essential to all successful green roof maintenance and should be carried out by fully trained personnel who should be:

- Familiar with working at rooftop levels.
- Able to carry out risk assessments.
- Inspecting mansafe equipment prior to use.
- Competent users of all apparatus.
- Wear all necessary personal protective equipment.



OUR MAINTENANCE SERVICE

With over 35 years' experience in the design and supply of green roofs throughout the UK and Ireland, we offer unparalleled knowledge and horticultural expertise for rooftop vegetation and green roof maintenance.

Our national coverage assures you of a prompt reliable service to fully meet your requirements and comprises a full inspection and evaluation of your green roof.

Our experienced maintenance team will fully comply with relevant health and safety legislation throughout the duration of the work to access the roof with suitable edge protection or fall protection systems; carry out pre-use inspections of all maintenance equipment, wear personal protective equipment where necessary; and risk assess all works prior to commencement.

Following each visit you will be provided with a bespoke report that highlights the work carried out, the condition of the roof and any necessary future works to be considered.

Call our team for a no obligation quote.

Sedum Roof Maintenance

It is a common misconception that extensive green roofs are maintenance free, but this is not the case and annual maintenance is required. Our sedum maintenance service typically concentrates on:

- Ensuring adequate fertilisation of the sedum blanket.
- Evaluating colour and growth rate of vegetation.
- Removal of leaves, debris and any unwanted invasive weeds or plants.
- Repairing of any bare patches.
- Clearance of outlets and testing of irrigation.

Biodiverse & Wildflower Maintenance

The level of maintenance of the horticultural element of this type of green roof varies significantly depending on the species of vegetation incorporated, and our biodiverse and wildflower maintenance service typically focuses on:

- Ensuring a suitable balance of species on the roof.
- Removal of leaves, debris and any unwanted invasive weeds.
- Strimming back of vegetation and sward growth where applicable.
- Ensuring adequate fertilisation of the vegetation.
- Examining and testing of irrigation.



TECHNICAL
DESIGN