

LOCATION PLAN
NTS

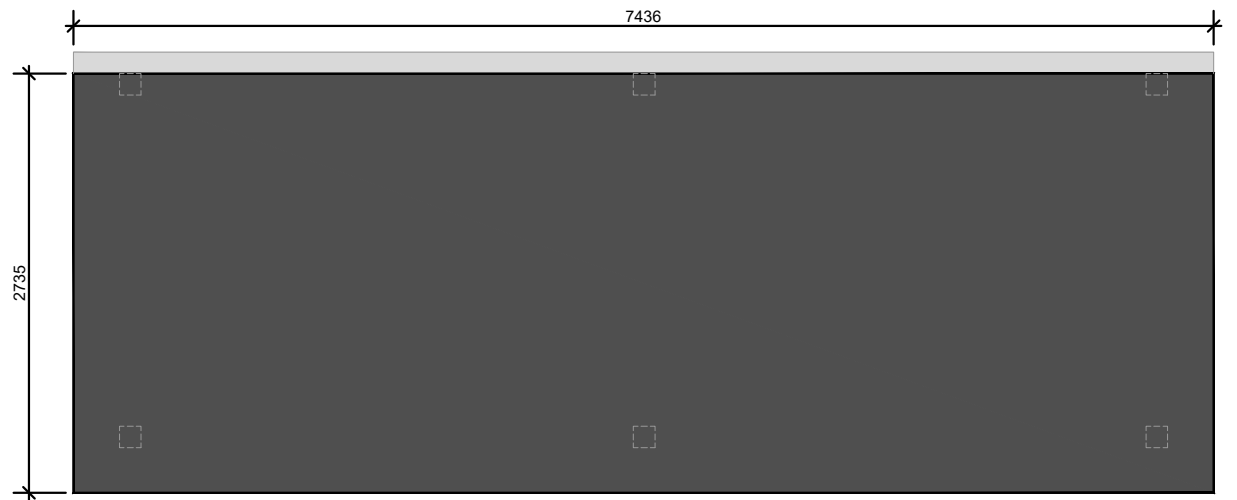

Roof Plan

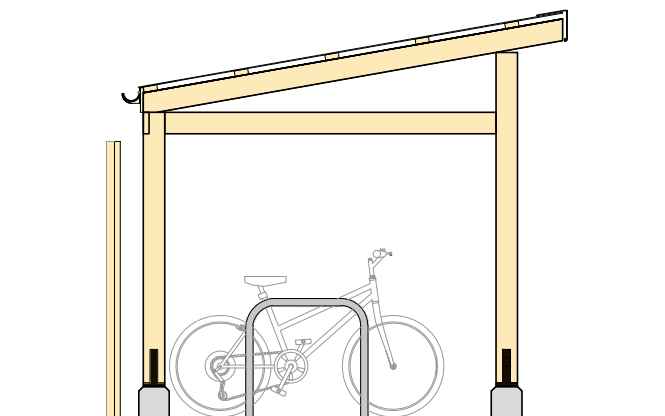

Side Elevation

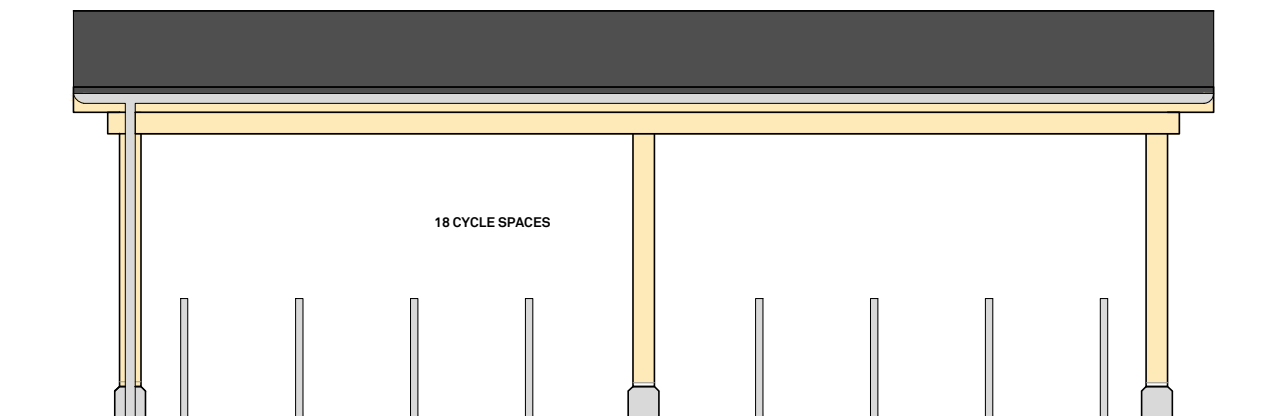

Rear Elevation

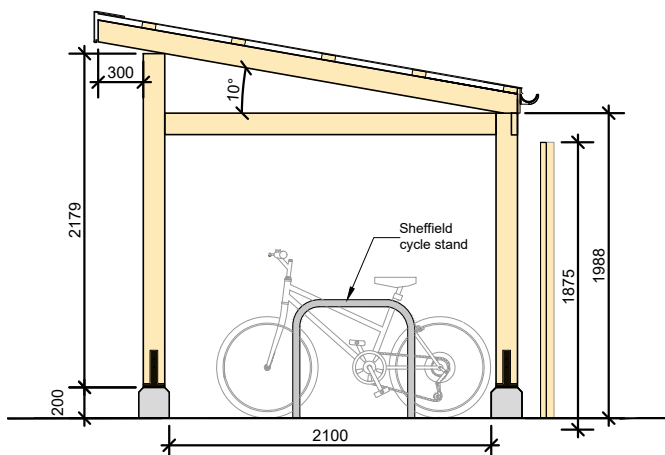

Side Elevation

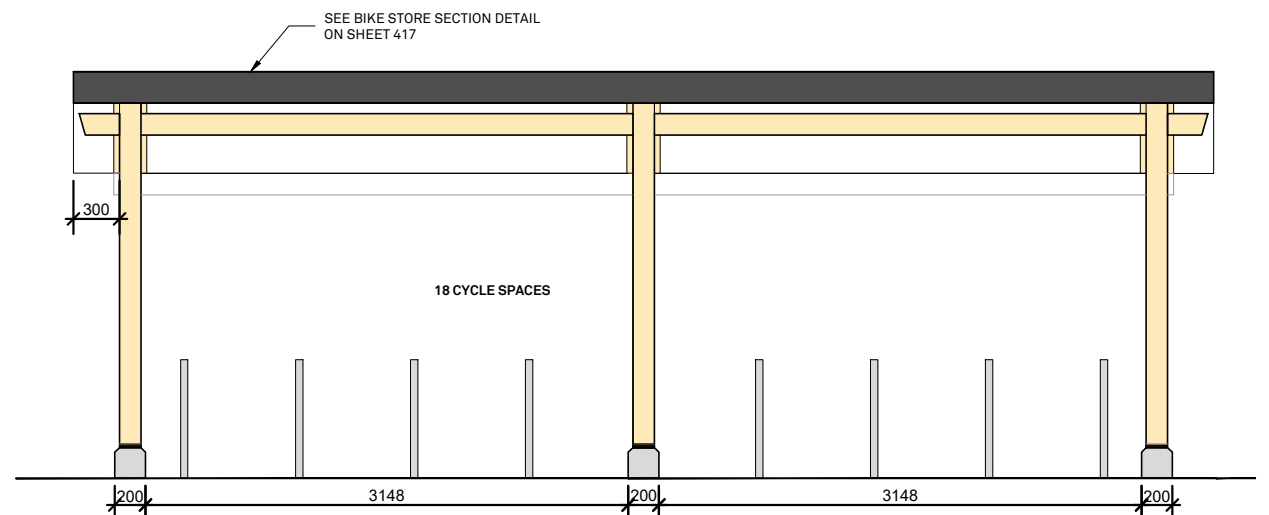

Front Elevation

Sheffield Stand
Foundation Section

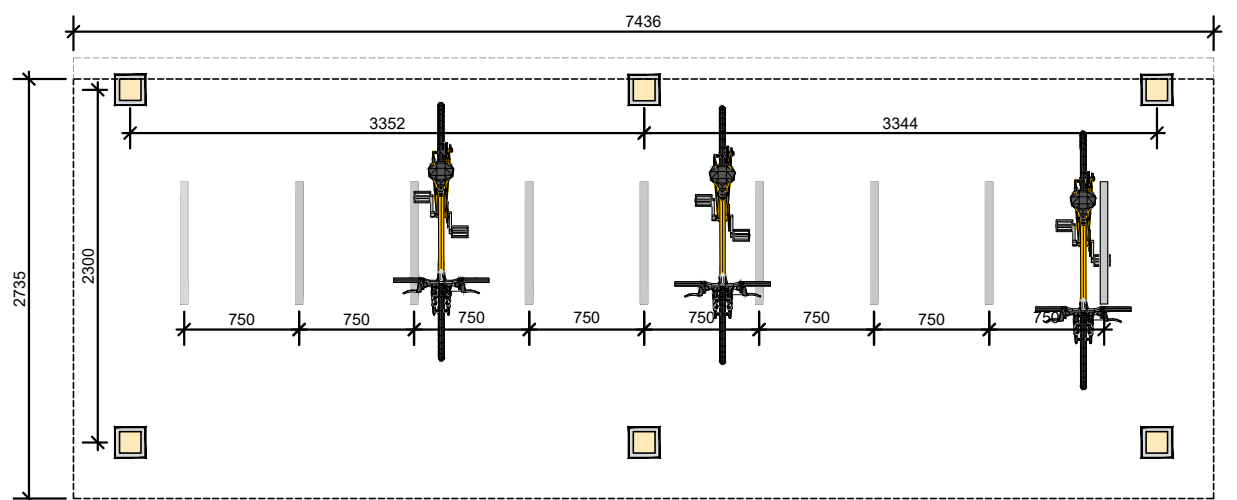
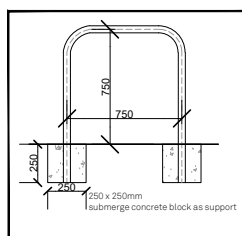

Floor Plan

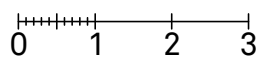

PRELIMINARY	
FOR APPROVAL	
TENDER	
CONSTRUCTION	✓
AS BUILT	

REVISIONS

PROJECT

110 GREENCROFT GARDENS
London, NW6 3PH

DRAWING TITLE

BIKE STORE DETAIL
(1 OF 2)

SCALE

1:50 @ A3

REV /

DRAWING NO.
40068.416

DRAWN
LO