

**WINDOW TYPE**  
WT 001  
WT 005  
WT 009

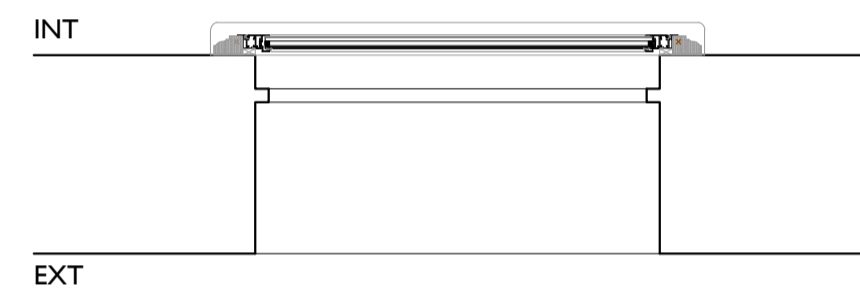

**WINDOW TYPE**  
WT 002  
WT 006

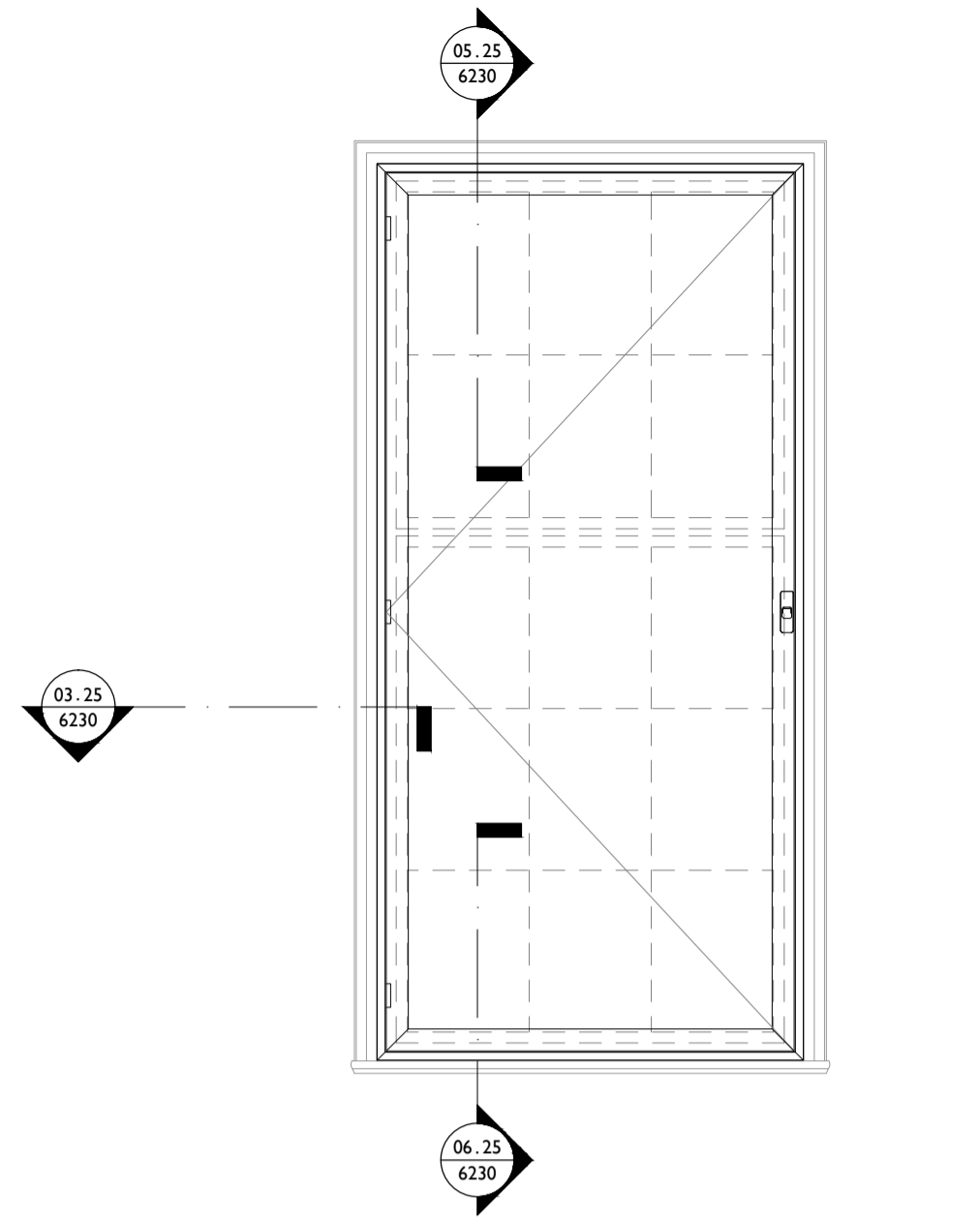
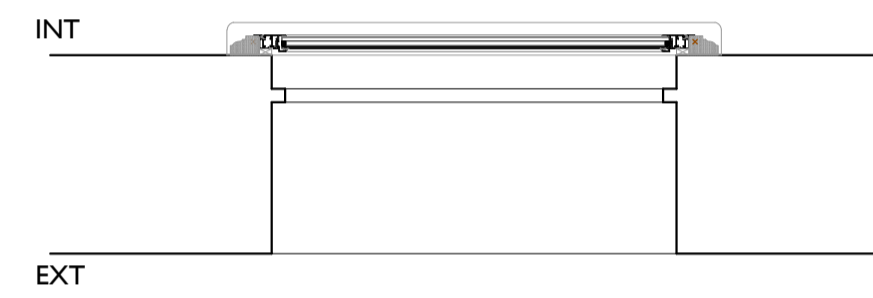
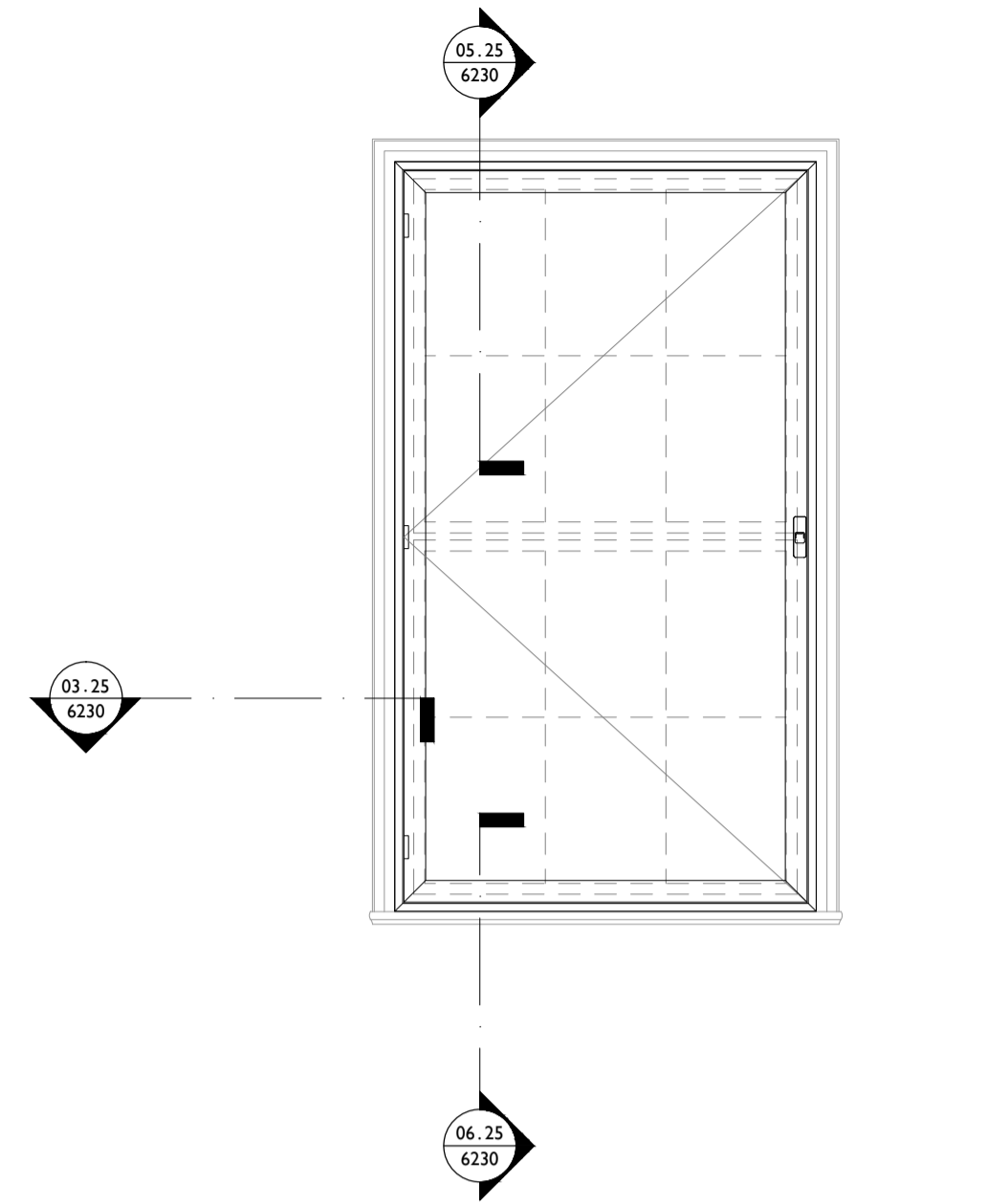

**WINDOW TYPE**  
WT 003  
WT 020

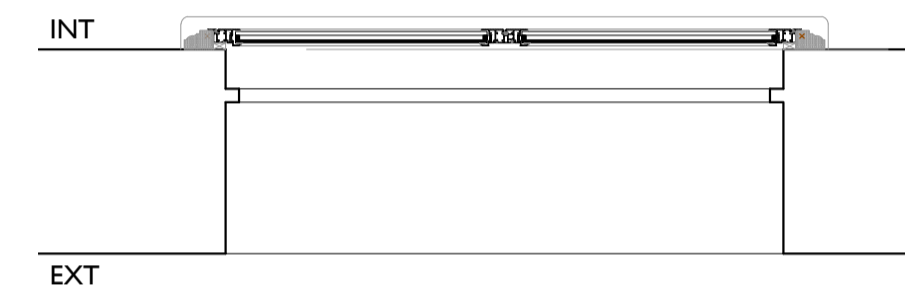
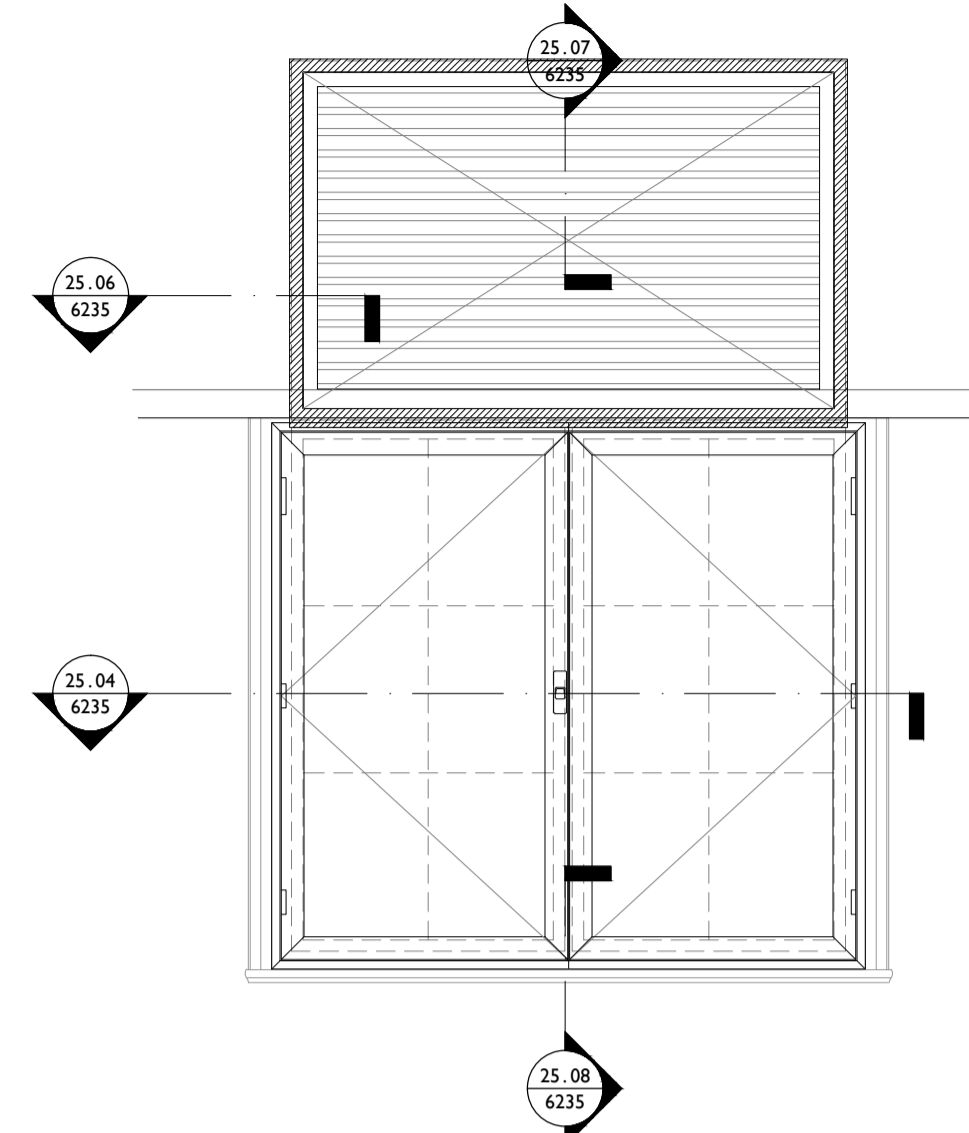

**WINDOW TYPE**  
WT 011

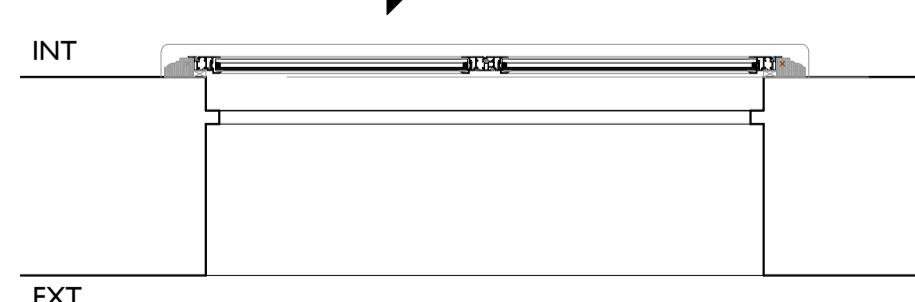
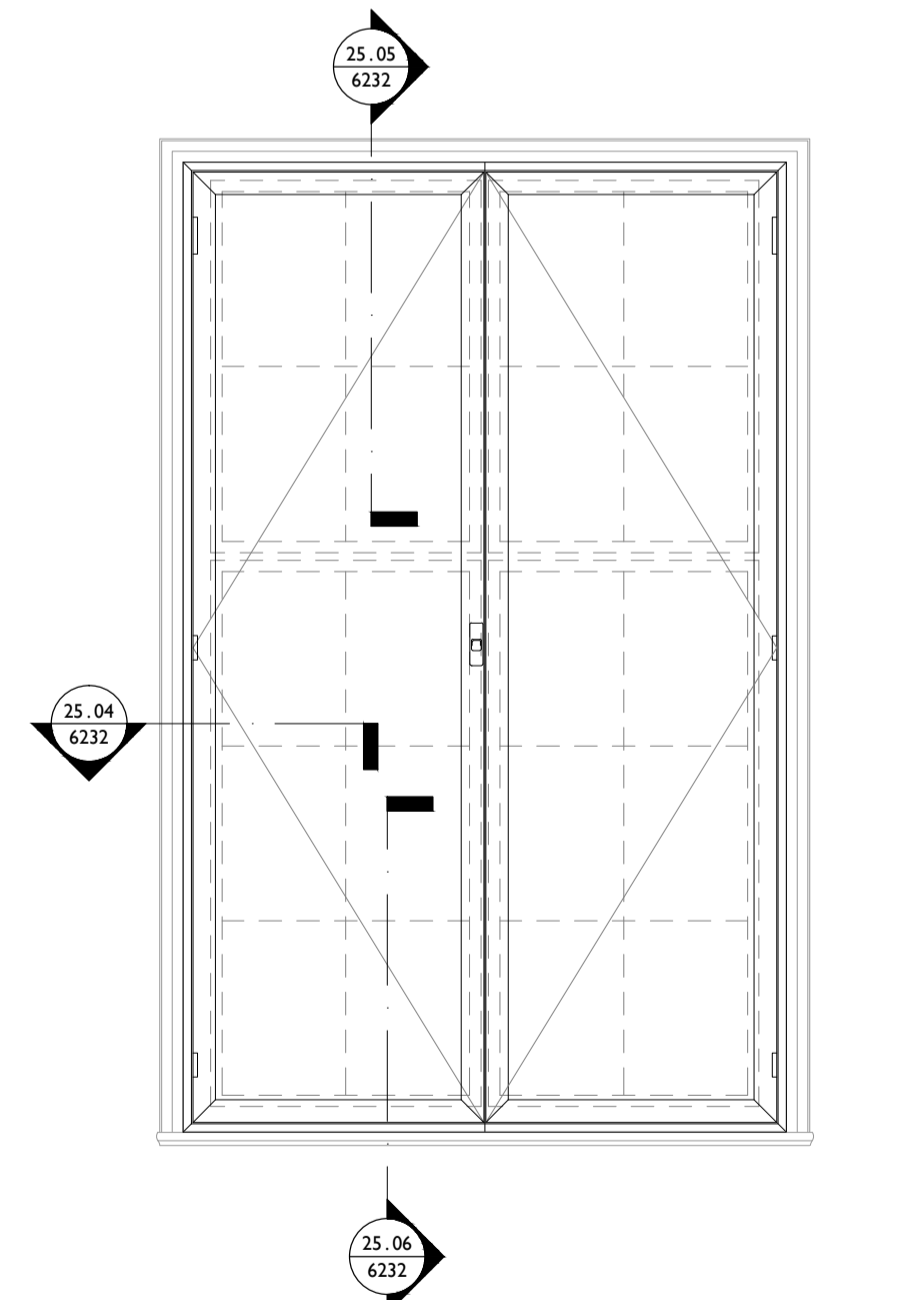

**WINDOW TYPE**  
WT 021

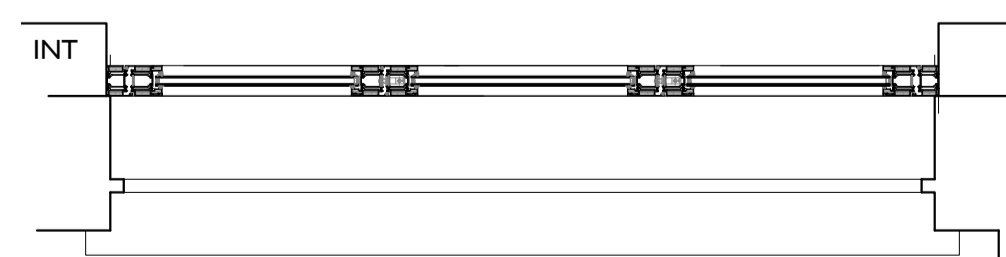
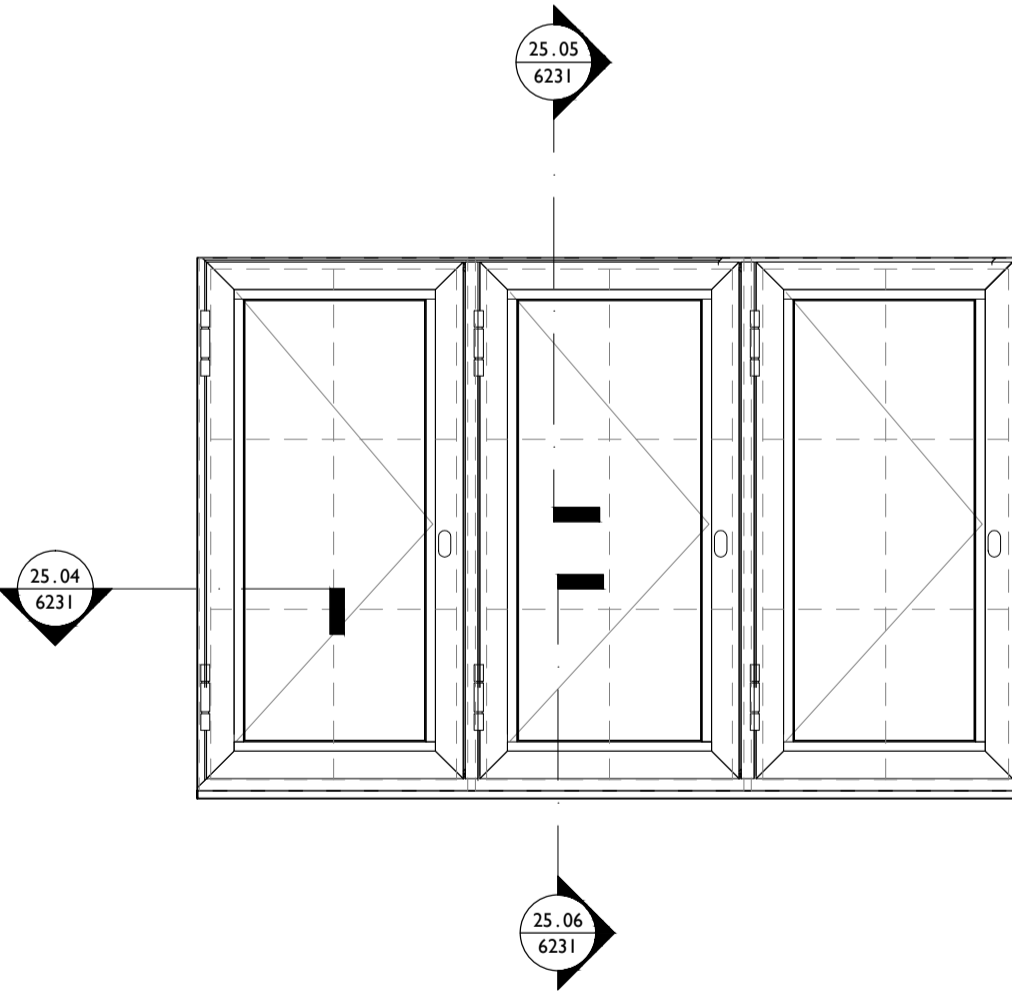

**WINDOW TYPE**  
WT 022

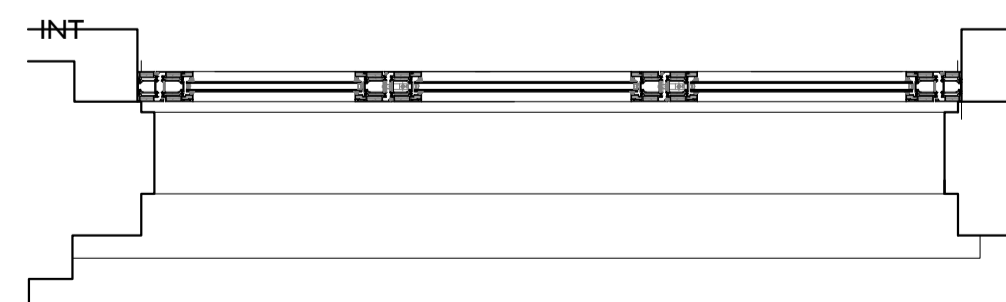
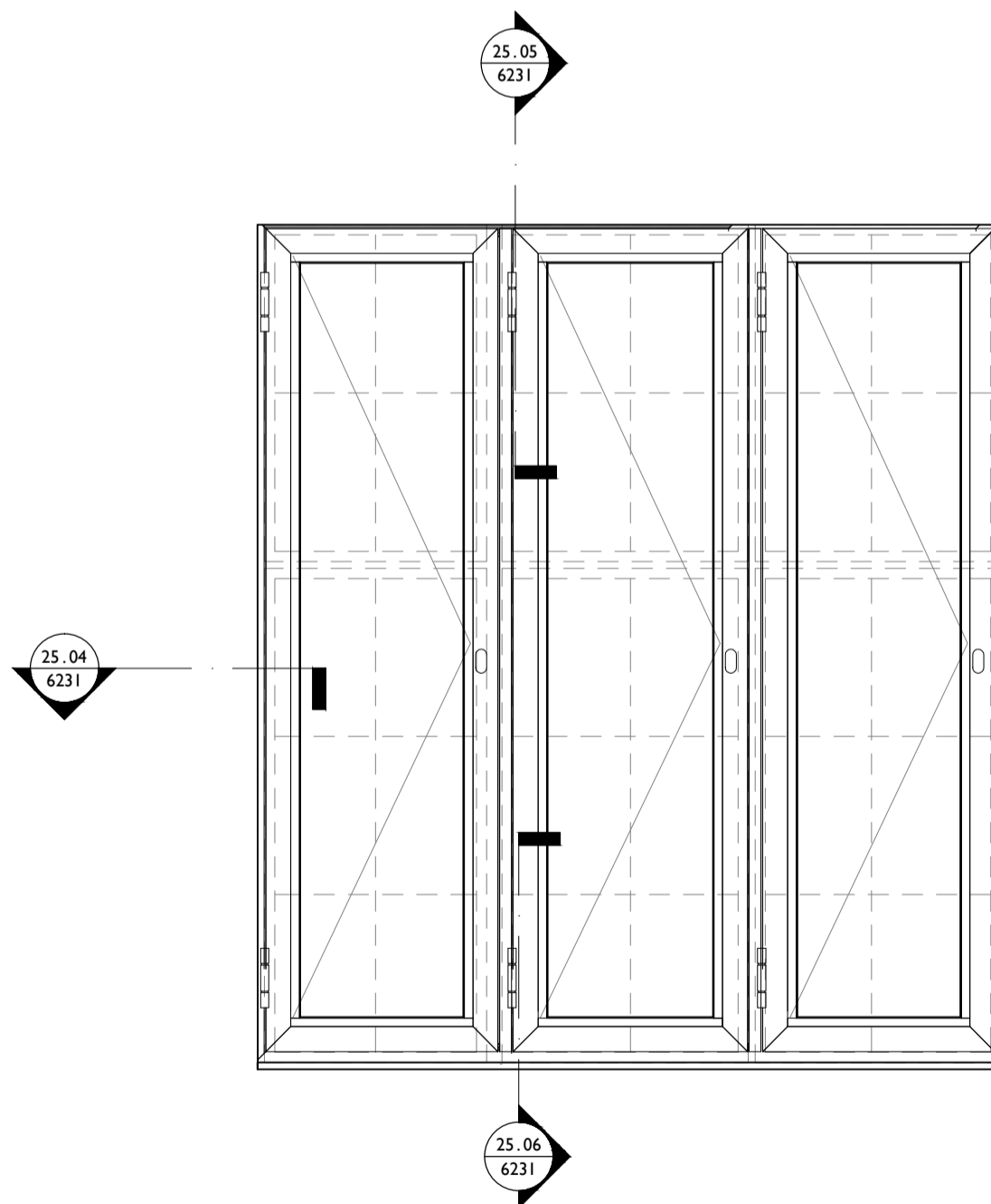

**WINDOW TYPE**  
WT 023

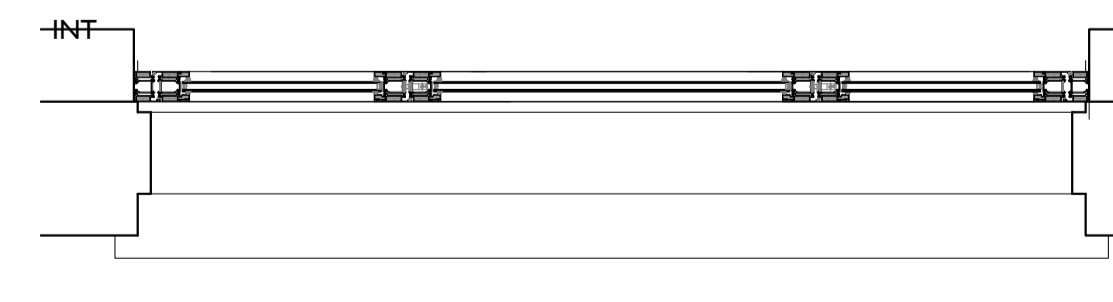
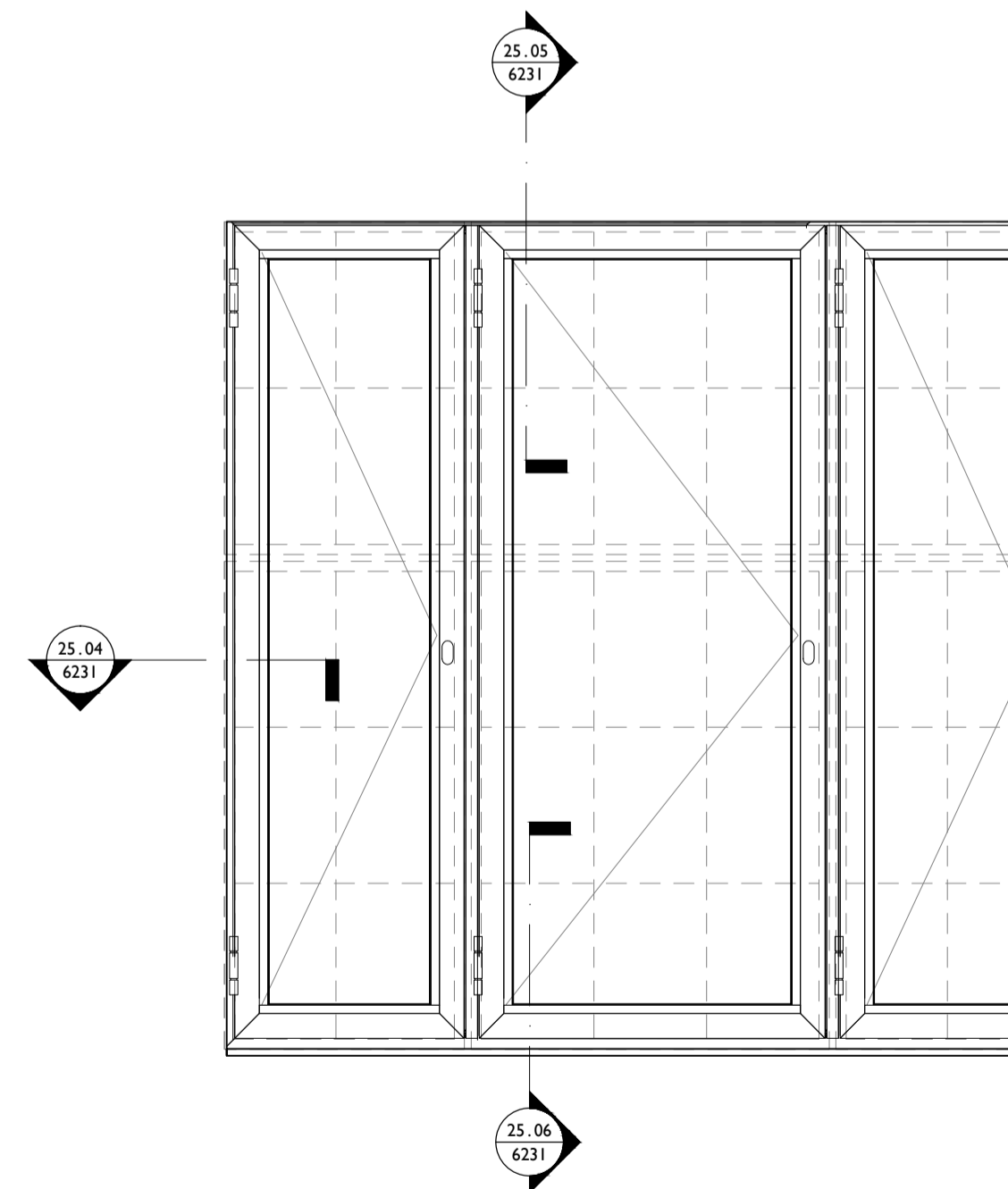

**WINDOW TYPE**  
WT 024

**Notes:**

Drawings are based on survey data and may not accurately represent what is physically present.

Do not scale from this drawing. All dimensions are to be verified on site before proceeding with the work.

All dimensions are in millimeters unless noted otherwise.

Purcell shall be notified in writing of any discrepancies.

1:10 Scale

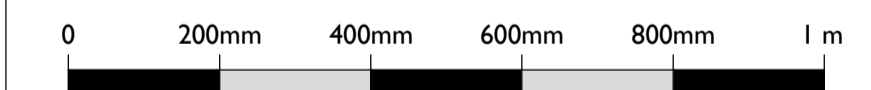

T00 30 Sep 2019 nicolasmith

First Issue 30 Sep 2019 NS NS

ISSUE	DATE	DRAWN	CHECKED	DESCRIPTION
T00	30 Sep 2019	nicolasmith		

**DRAWING TITLE** Secondary Glazing Window Types  
Ground Floor

**DRAWING NO.** CTH-PUR-XXX-DR-25-6210

**REVISION** T00

**SIZE & SCALE** A1L 1:10

**DRAWING STATUS** ISSUED FOR TENDER

**CLIENT** Lendlease

**PROJECT** Camden Town Hall

**JOB NUMBER** 238664

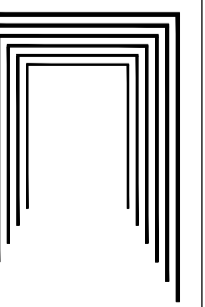

**PURCELL**