

STAGE 1
LOCALISED LEVEL REDUCTION

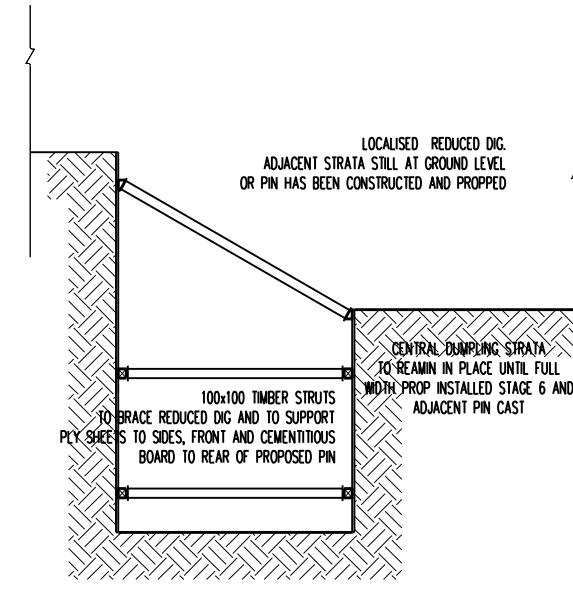

STAGE 2
EXCAVATE TO FORM UNDERPIN

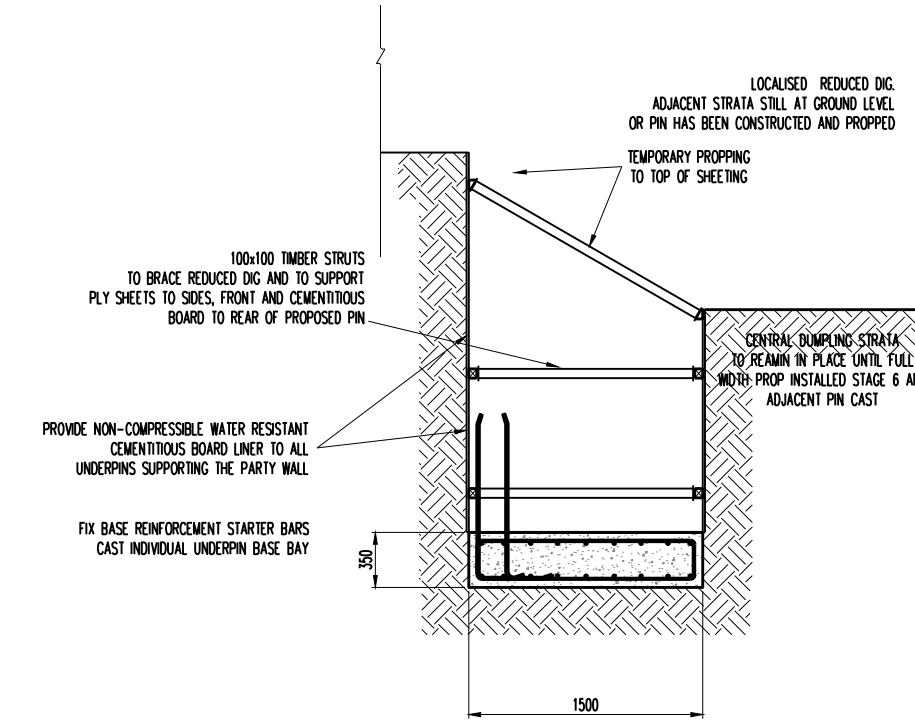

STAGE 3
CONCRETE BASE OF UNDERPIN

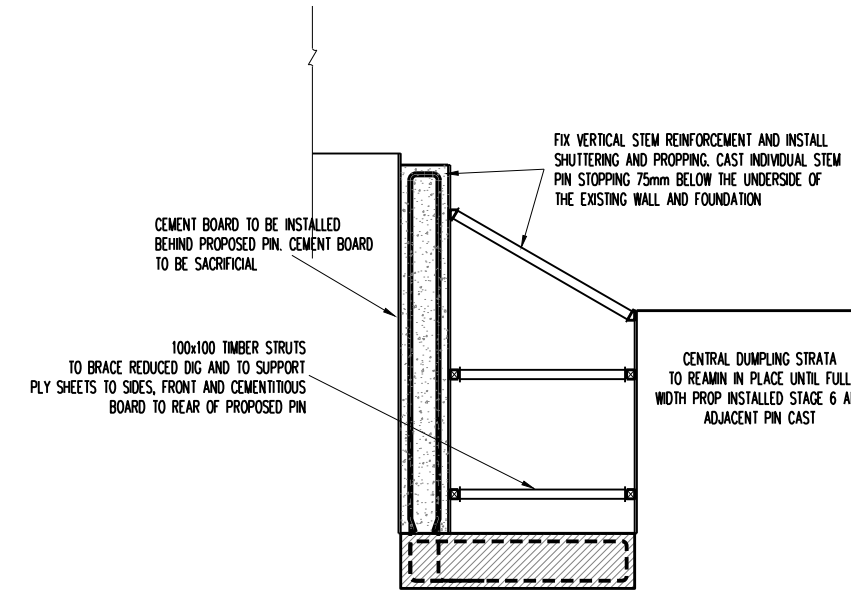

STAGE 4
ERECT SHUTTER CONCRETE STEAM OR UNDERPIN

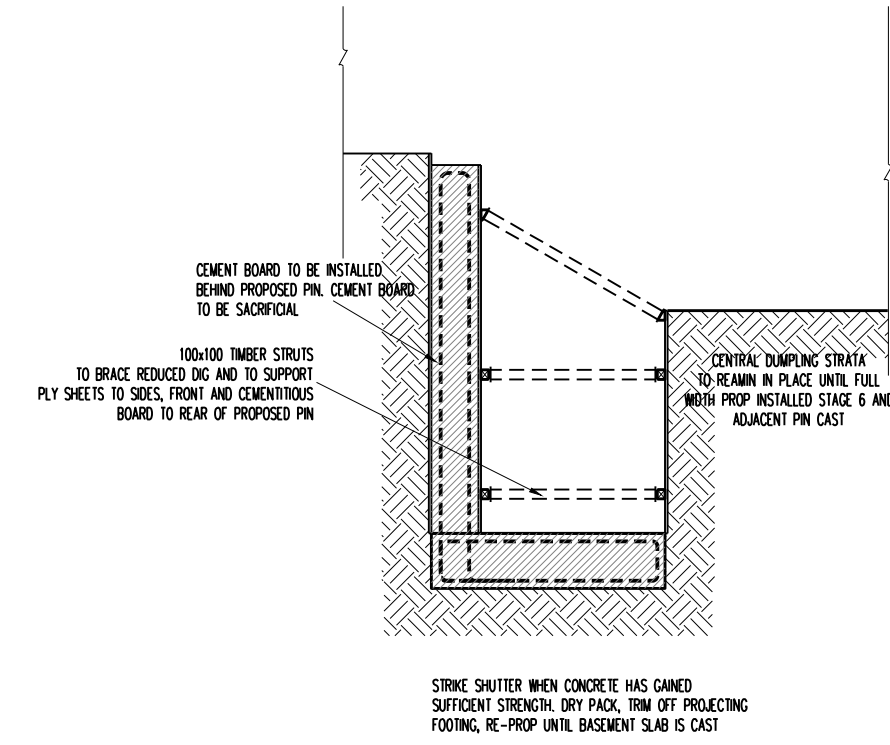

STAGE 5
STRIKE SHUTTER

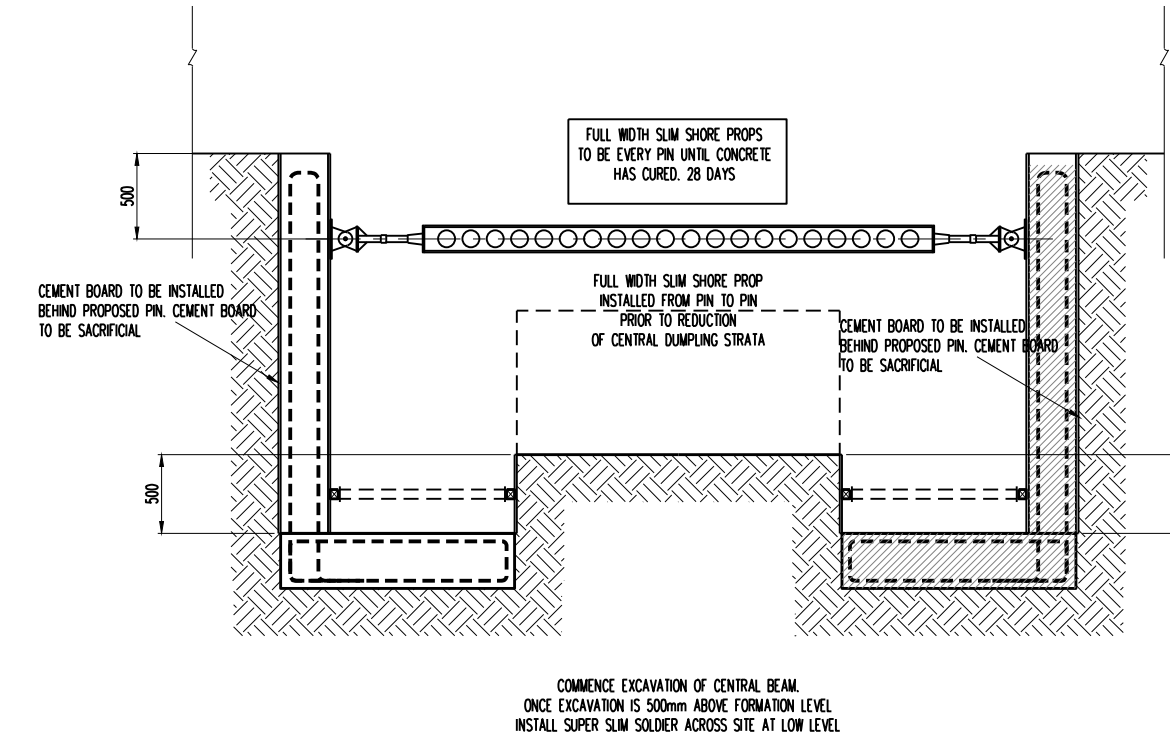

STAGE 6
COMMENCE EXCAVATION

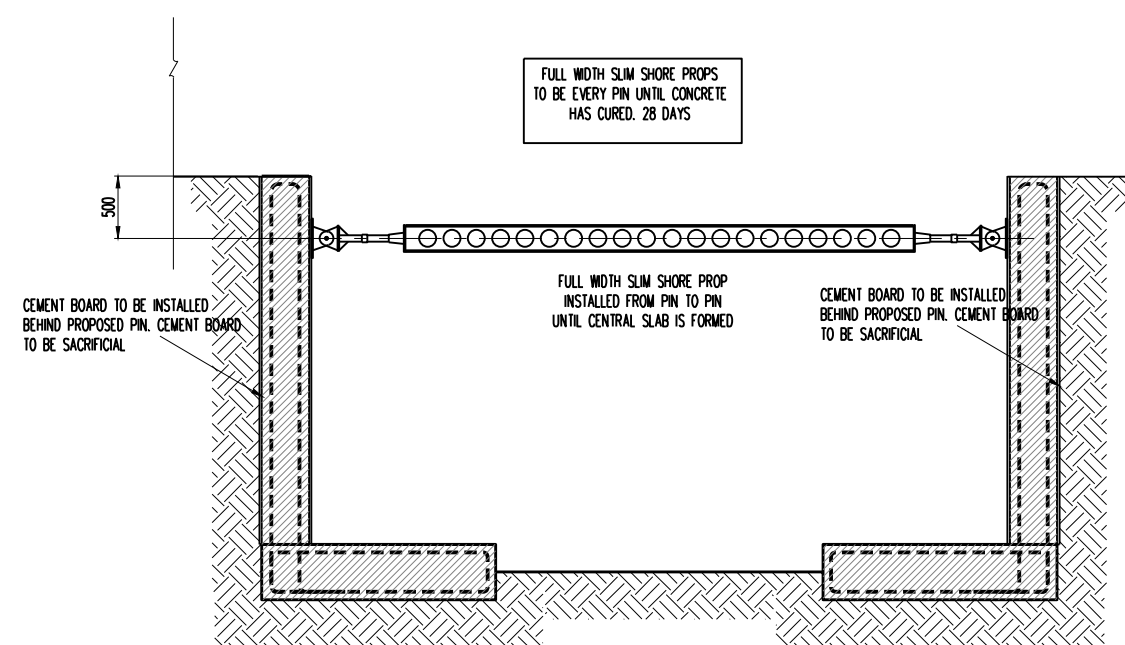

STAGE 7
COMMENCE EXCAVATION

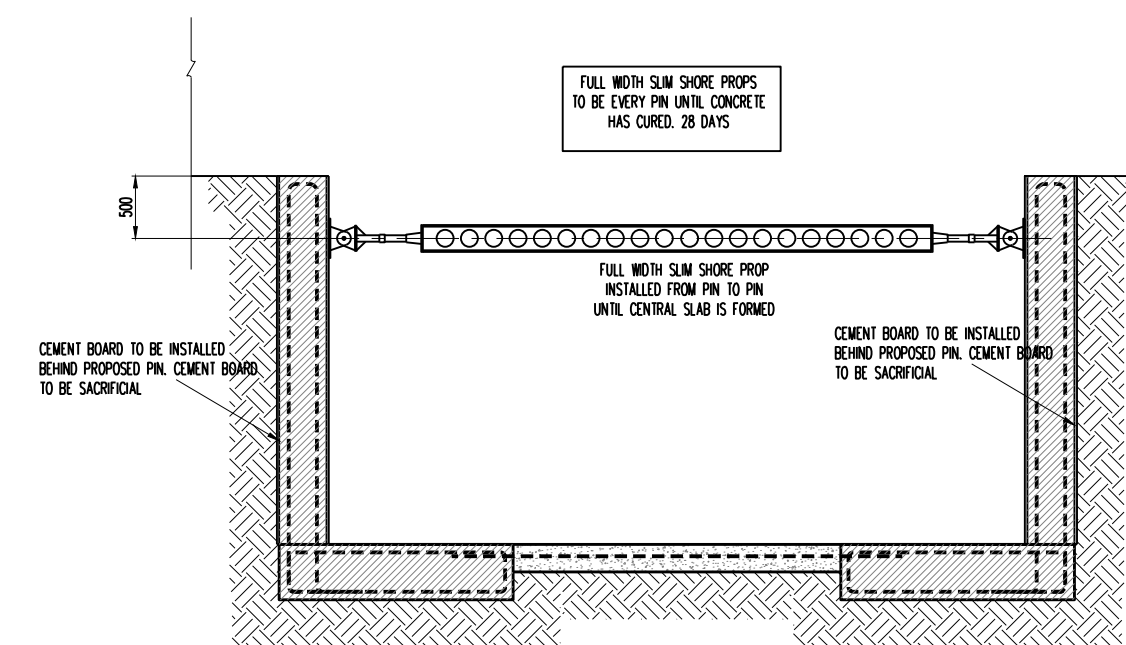

STAGE 8
CAST SLAB

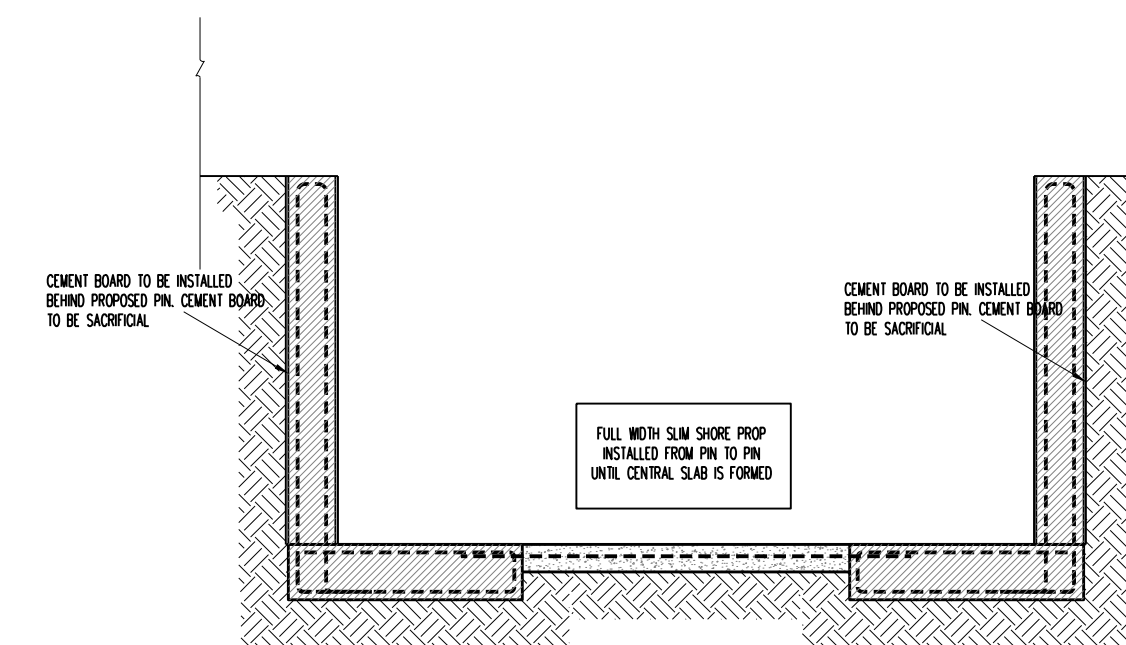

STAGE 9
COMPLETE

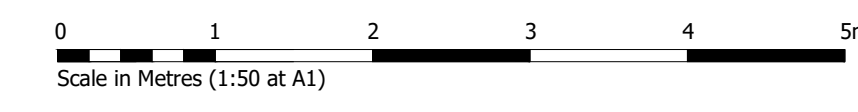

0	ORIGINAL ISSUE	XXX	MJB
REV	DESCRIPTION	DATE	BY
 Unit 1, 100 North Road, Brighton, East Sussex, BN1 1YE T: 01273 609742 M: 07968 188928 W: www.mitchinsonmacken.co.uk E: info@mitchinsonmacken.co.uk			
PROJECT PARSIFAL HOUSE 521 FINCHLEY ROAD LONDON			
DRAWING TEMPORARY WORKS			
DRAWING No.	19313 / 101	REV	CHECKED
SCALE	As Shown	DATE	July 19
		DRAWN	MJB
		APPROVED	