

# Morrisons Camden Temporary Store

Lighting Assessment  
Planning Condition Discharge: Condition 60

June 2020

## Quality information

Prepared by	Checked by	Verified by	Approved by
Patricia Brock Associate Director, Lighting	Anna Rooney Associate Director, Lighting		

## Revision History

Revision	Revision date	Details	Authorized	Name	Position
0	2020-06-15	Draft			
1	2020-06-23	Draft for Final			
2	2020-06-23	Final			

## Distribution List

# Hard Copies	PDF Required	Association / Company Name

Prepared for:

Prepared by:

Patricia Brock  
Associate Director, Lighting  
T: +44 (0) 2077762396  
M: +44 (0) 7823 357418  
E: patricia.brock@aecom.com

AECOM Limited  
Aldgate Tower  
2 Leman Street  
London E1 8FA  
United Kingdom  
aecom.com

© 2020 AECOM Limited. All Rights Reserved.

This document has been prepared by AECOM Limited ("AECOM") for sole use of our client (the "Client") in accordance with generally accepted consultancy principles, the budget for fees and the terms of reference agreed between AECOM and the Client. Any information provided by third parties and referred to herein has not been checked or verified by AECOM, unless otherwise expressly stated in the document. No third party may rely upon this document without the prior and express written agreement of AECOM.

## Table of Contents

<b>1. Introduction</b> .....	<b>6</b>
Condition Requirements.....	6
Policy and Guidance.....	6
Camden Local Plan 2017.....	6
Streetscape Design Manual.....	8
Good Practice Guidance.....	8
Consultation.....	8
Scope of Assessment.....	8
<b>2. Proposed Development Overview</b> .....	<b>10</b>
Site Location.....	10
Site Context.....	11
Receptors.....	12
Residential Properties.....	12
Wildlife (Bats).....	12
Rail (Train Drivers).....	12
<b>3. Lighting Strategy and Design</b> .....	<b>13</b>
Technical requirements and design performance.....	13
Car Park.....	13
Building Perimeter.....	13
Main Entrance.....	14
Lighting Against Crime requirements.....	14
Environmental requirements.....	14
Environmental Target Criteria.....	14
Energy and Sustainability Criteria.....	16
Lighting Design.....	16
Lighting Control.....	18
<b>4. Technical Assessment</b> .....	<b>19</b>
Maintenance and Maintenance Factor.....	20
Simulated Lighting Performance.....	20
Light spill.....	20
Sky glow.....	20
Glare.....	20
<b>5. Summary</b> .....	<b>21</b>
Appendix A Lighting Design.....	22

## Figures

Figure 1 – Proposed site location for the Morrisons Camden Temporary Store site (google earth overlay, approximate site area in red).....	10
Figure 2 – Proposed site arrangements for the Morrisons Camden Temporary Store (extract drawing Morrisons Camden Temporary Store External Ltg Rev 2).....	11
Figure 3 – Proposed east boundary condition (google streetview overlay, June 2019).....	11
Figure 4 – Proposed north boundary condition (google streetview overlay, June 2019).....	12
Figure 5 – Proposed south and west boundary (google streetview overlay, June 2019).....	12
Figure 6 – Proposed lighting arrangements by Holophane (extract Morrisons Camden Temporary Store External Ltg Rev 2 overlay).....	13
Figure 7 – Lighting arrangements, plan view overlay (extract Morrisons Camden Temporary Store External Ltg Rev 2 overlay).....	17

Figure 8 (a,b) – Lighting arrangements, a) west and b) east elevations overlay (extract building elevations plan 200227-25B, April 2020)..... 17

Figure 9 (a,b) – Lighting arrangements, a) south and b) north elevations overlay (extract building elevations plan 200227-25B, April 2020)..... 18

Figure 10 - Simulated lighting performance – white light graphic..... 19

Figure 11 - Simulated lighting performance – false colour graphic in lux..... 19

## Tables

Table 1 – Lighting environmental zones ..... 15

Table 2 – Lighting threshold criteria – Maximum vertical illuminance on properties (light spill) ..... 15

Table 3 – Lighting threshold criteria – Limits for luminous intensity (glare)..... 15

Table 4 – Lighting threshold criteria – Limits for upward light (sky glow) ..... 16

Table 5 – Lighting design equipment specification and installation parameters ..... 18

# 1. Introduction

On 15 June 2018 full planning permission (ref: 2017/3847/P) was granted for the redevelopment of Camden Goods Yard, comprising the Petrol Filling Station (PFS) site and Main Supermarket site.

On 5 May 2020, a Section 73 application (ref: 2020/0034/P) was granted for variation of Condition 4 (approved drawings) of the existing permission to secure a single storey temporary food store on the PFS site, with associated parking, servicing, access and landscaping.

This report responds specifically to the discharge requirements of condition 60, in respect of the lighting strategy for the single storey temporary food store on the PFS site.

## Condition Requirements

Planning Condition 60 in full states:

*Prior to commencement of the first building superstructure on the PFS land parcel, a lighting strategy for the relevant areas of the public realm and fittings to the exterior of buildings on that parcel shall be submitted to and approved in writing by the local planning authority.*

*Prior to commencement of the first building superstructure on the Main Site land parcel, a lighting strategy for the relevant areas of the public realm and fittings to the exterior of buildings on that parcel shall be submitted to and approved in writing by the local planning authority.*

*Such strategy for the relevant parcel of land shall be developed with input from a specialist lighting engineer accredited by the Institute of Lighting Engineers and shall incorporate (inter alia) consideration of the impact of the lighting design on the needs of wildlife (including bats), contributing to reducing crime, residential properties within and outwith the site, maintenance, whole life cost and energy use and safe operation of the railways.*

*The details shall include the following, where relevant to that land parcel:*

- a) *lighting to the streets and circulation areas in the public realm*
- b) *external elevations of buildings including entrances and any architectural lighting*
- c) *lighting within all publically accessible areas of ground floor in the Petrol Filling Station*
- d) *details of any lighting to the Camden Goods Yard signage on Block B*
- e) *incorporation of measures to take account of the foraging and roosting habitat for bats to the south of the site and along the railway corridors by referencing Bat Conservation Guidelines*
- f) *incorporation of street lighting designed to Camden's Streetscape Design Manual*

*Where new lighting is to be erected adjacent to the operational railway the potential for train drivers to be dazzled must be eliminated. In addition the location of lights must not give rise to the potential for confusion with the signalling arrangements on the railway. The development on the relevant parcel of land shall not be carried out in accordance with the details thus approved for that parcel of land and shall be fully implemented before the premises on that parcel of land are first occupied.*

Reason: To maintain a high quality of amenity and a safe environment, in accordance with Policies D1 and A3 of the Camden Local Plan 2017.

## Policy and Guidance

### Camden Local Plan 2017

**Policy D1 Design** seeks to secure high quality design in development. The Council will require that development:

- a) *respects local context and character;*
- b) *preserves or enhances the historic environment and heritage assets in accordance with Policy D2 Heritage;*
- c) *is sustainable in design and construction, incorporating best practice in resource management and climate change mitigation and adaptation;*
- d) *is of sustainable and durable construction and adaptable to different activities and land uses;*
- e) *comprises details and materials that are of high quality and complement the local character;*
- f) *integrates well with the surrounding streets and open spaces, improving movement through the site and wider area with direct, accessible and easily recognisable routes and contributes positively to the street frontage;*
- g) *is inclusive and accessible for all;*
- h) *promotes health;*
- i) *is secure and designed to minimise crime and antisocial behaviour;*
- j) *responds to natural features and preserves gardens and other open space;*
- k) *incorporates high quality landscape design (including public art, where appropriate) and maximises opportunities for greening for example through planting of trees and other soft landscaping, incorporates outdoor amenity space;*
- l) *preserves strategic and local views;*
- m) *for housing, provides a high standard of accommodation; and*
- n) *carefully integrates building services equipment.*

This policy also states “*The Council will resist development of poor design that fails to take the opportunities available for improving the character and quality of an area and the way it functions.*”

**Policy A3 Biodiversity** seeks to enhance the borough’s biodiversity. The Council will require that development aims to maximise opportunities for biodiversity by protecting and enhancing sites of nature conservation and biodiversity and this policy sets out that they will:

- a) *designate and protect nature conservation sites and safeguard protected and priority habitats and species;*
- b) *grant permission for development unless it would directly or indirectly result in the loss or harm to a designated nature conservation site or adversely affect the status or population of priority habitats and species;*
- c) *seek the protection of other features with nature conservation value, including gardens, wherever possible;*
- d) *assess developments against their ability to realise benefits for biodiversity through the layout, design and materials used in the built structure and landscaping elements of a proposed development, proportionate to the scale of development proposed;*
- e) *secure improvements to green corridors, particularly where a development scheme is adjacent to an existing corridor;*
- f) *seek to improve opportunities to experience nature, in particular where such opportunities are lacking;*
- g) *require the demolition and construction phase of development, including the movement of works vehicles, to be planned to avoid disturbance to habitats and species and ecologically sensitive areas, and the spread of invasive species;*
- h) *secure management plans, where appropriate, to ensure that nature conservation objectives are met; and*
- i) *work with The Royal Parks, The City of London Corporation, the London Wildlife Trust, friends of park groups and local nature conservation groups to protect and improve open spaces and nature conservation in Camden.*

*Trees and vegetation: The Council will protect, and seek to secure additional, trees and vegetation. We will:*

- j) *resist the loss of trees and vegetation of significant amenity, historic, cultural or ecological value including proposals which may threaten the continued wellbeing of such trees and vegetation;*
- k) *require trees and vegetation which are to be retained to be satisfactorily protected during the demolition and construction phase of development in line with BS5837:2012 'Trees in relation to Design, Demolition and Construction' and positively integrated as part of the site layout;*
- l) *expect replacement trees or vegetation to be provided where the loss of significant trees or vegetation or harm to the wellbeing of these trees and vegetation has been justified in the context of the proposed development;*
- m) *expect developments to incorporate additional trees and vegetation wherever possible.*

## Streetscape Design Manual

Street furniture is identified within the Streetscape Design Manual in Section 4.08 which sets out requirements for street lighting including finishes, placement and performance requirements. The Manual also advises that white light must be used for all new lighting on all roads for better colour rendition and specifically excludes the use of high and low pressure sodium lamps.

## Good Practice Guidance

Institute of Lighting Professionals (ILP) guidance:

- GN01: 2020 Guidance notes for the reduction of obtrusive light - Guidance which is used throughout the industry that presents limiting criteria for direct obtrusive lighting effects (such as light spill, sky glow and glare) suitable to a given area brightness condition as well as good practice design approaches.
- 08/18, Bats and Lighting in the UK (written with the Bat Conservation Trust) – Guidance provided for light levels and colour temperature impacts on different bat species. It also looks at potential solutions to avoid and reduce this harm.

Secure by Design:

- Lighting Against Crime – Guidance provided as part of a police initiative to encourage the building industry to adopt crime prevention measures in the design of development to assist in reducing the opportunity for crime and the fear of crime.

## Consultation

A Preliminary Bat Roost Assessment was undertaken for Camden Goods Yard with the findings presented in RT-MME-151076-02 Rev A, submitted November 2019. The information contained within that report is considered alongside the technical requirements of proposed new lighting.

## Scope of Assessment

The discharge of Planning Condition 60 for the Temporary Store will not incorporate all requirements due to the nature of the design for the proposed development. Some elements of the Condition apply only to the main store development. This report will provide:

- An overview of the lighting strategy for the relevant areas of the public realm and fittings to the exterior of buildings on the Petrol Filling Station site; and
- Technical assessment of the impact of the lighting design on the needs of wildlife (including bats), residential properties within and outwith the site and safe operation of the railways.

An overview is provided which considers contribution to crime reduction, maintenance, whole life cost and energy use developed alongside the detailed lighting strategy.

Details to be provided in assessment of the Temporary Store lighting shall address the following:

- lighting to the streets and circulation areas in the public realm;



- external elevations of buildings including entrances and any architectural lighting; and
- lighting within all relevant publicly accessible areas of ground floor in the Petrol Filling Station
- incorporation of measures to take account of the foraging and roosting habitat for bats to the south of the site and along the railway corridors by referencing Bat Conservation Guidelines.

As some new lighting is set out in close proximity to the operational railway, assessment is also made of the potential to cause dazzle or give rise to confusion with the signalling arrangements on the railway.

## 2. Proposed Development Overview

The Morrisons Camden Temporary Store is proposed to provide services through the period where the Main Supermarket is under redevelopment. The Temporary Store is located where the current petrol filling station is, and on completion of the Main Supermarket its use as the temporary shop location will be discontinued.

New exterior lighting is proposed for the new public entrance, building perimeter, and car park / pedestrian access and circulation areas for the Morrisons Camden Temporary Store to support for safe use and access for visitors, staff and vendors.

The type of lighting required is associated with the Temporary Store only and does not alter the public realm or streetscape design.

### Site Location

Figure 1 provides an overview of the site location of the Temporary Store and existing petrol filling station. The approximate development area is indicated by a red hatch.

**Figure 1 – Proposed site location for the Morrisons Camden Temporary Store site** (google earth overlay, approximate site area in red)

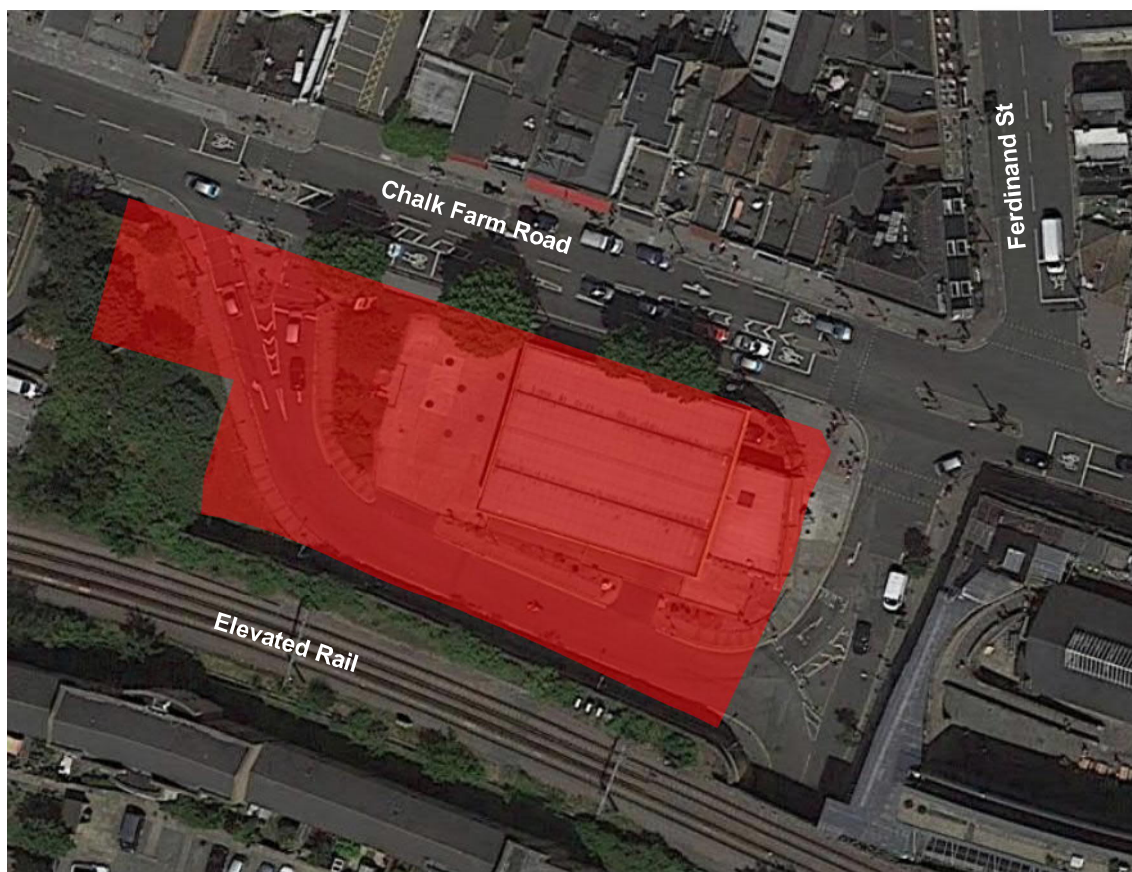
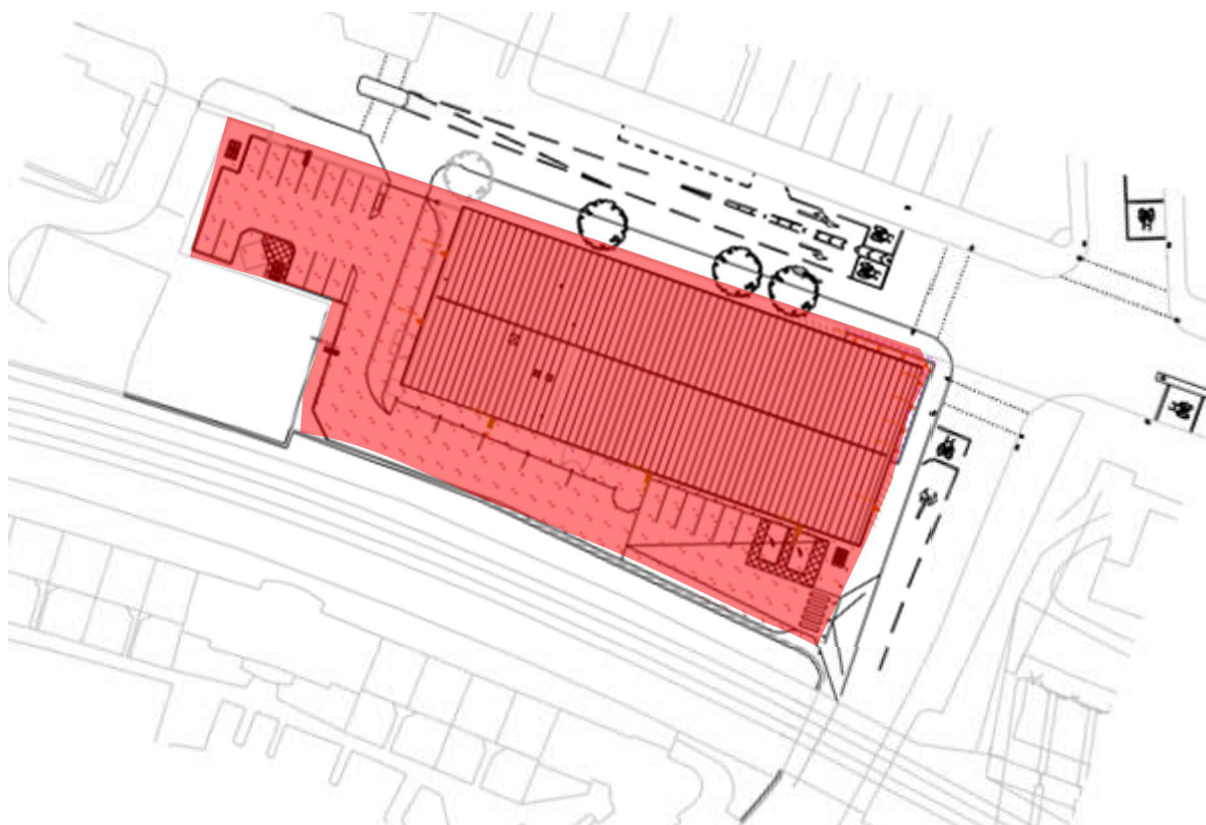

Figure 2 provides an overview of the proposed site arrangements in plan, showing the change in car park provision and proposed building footprint. The approximate development area is indicated by a red hatch.

**Figure 2 – Proposed site arrangements for the Morrisons Camden Temporary Store** (extract drawing Morrisons Camden Temporary Store External Ltg Rev 2)



## Site Context

The local context for the proposed Temporary Store Site is predominantly urban and in a heavily built up area with a significant amount of paving, hardstanding and commercial / retail development. There are some limited residential properties set back from the shops along Chalk Farm Road which may have direct views of the new Temporary Store but are not closely located. Figure 3, Figure 4 and Figure 5 show the boundary areas, the approximate development area is indicated by a red hatch.

**Figure 3 – Proposed east boundary condition** (google streetview overlay, June 2019)



Figure 4 – Proposed north boundary condition (google streetview overlay, June 2019)



Figure 5 – Proposed south and west boundary (google streetview overlay, June 2019)

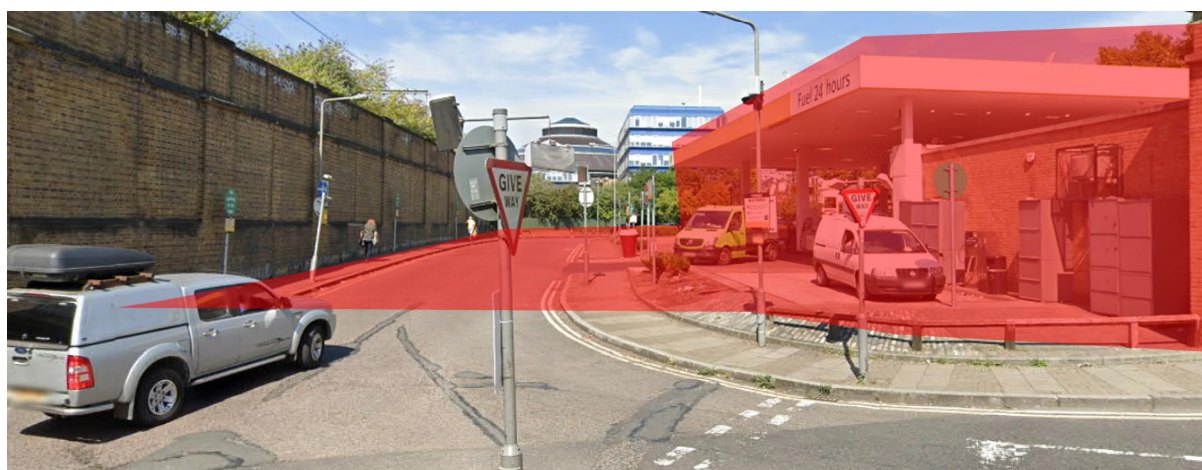

## Receptors

### Residential Properties

There are no residential properties located closely enough to the proposed lighting installation to be affected by it. Any properties with direct views of the site will see a visible difference in the site location and lighting condition, however this effect is more subjective and does not form part of this assessment.

### Wildlife (Bats)

The Preliminary Bat Roost Assessment report identifies that the potential for bats being present for foraging and commuting activities within the site boundary being low to moderate.

A detailed review for all buildings (internally and externally) was undertaken on site and they did not find evidence of bats. With consideration of urban area character and lack of evidence, it was determined that the petrol station and container office have a negligible potential for roosting bats.

Low to moderate foraging and roosting habitat is found immediately to the south of the site and precautionary measures are recommended in the preliminary report which advises limiting impacts of light pollution on bats through the careful use of lighting in critical areas close to the Grand Union Canal and at low level with minimum spillage.

### Rail (Train Drivers)

An elevated rail line runs directly to the south of the proposed development. This line is elevated and partially concealed from the site by a tall brick wall. There is a portion of the rail line which is more exposed as it crosses over through to the main Morrisons car park.

### 3. Lighting Strategy and Design

This following design strategy for new exterior lighting associated with the Morrisons Camden Temporary Store has been provided by Holophane in drawing Morrisons Camden Temporary Store External Ltg Rev 2. Figure 6 shows the different types of lighting requirements covering building entrance, building perimeter and car park shared surfaces.

The lighting assessment will review this strategy and its performance in relation to obtrusive light, in particular light spill, sky glow and glare, based on the local area lighting character.

**Figure 6 – Proposed lighting arrangements by Holophane** (extract Morrisons Camden Temporary Store External Ltg Rev 2 overlay)

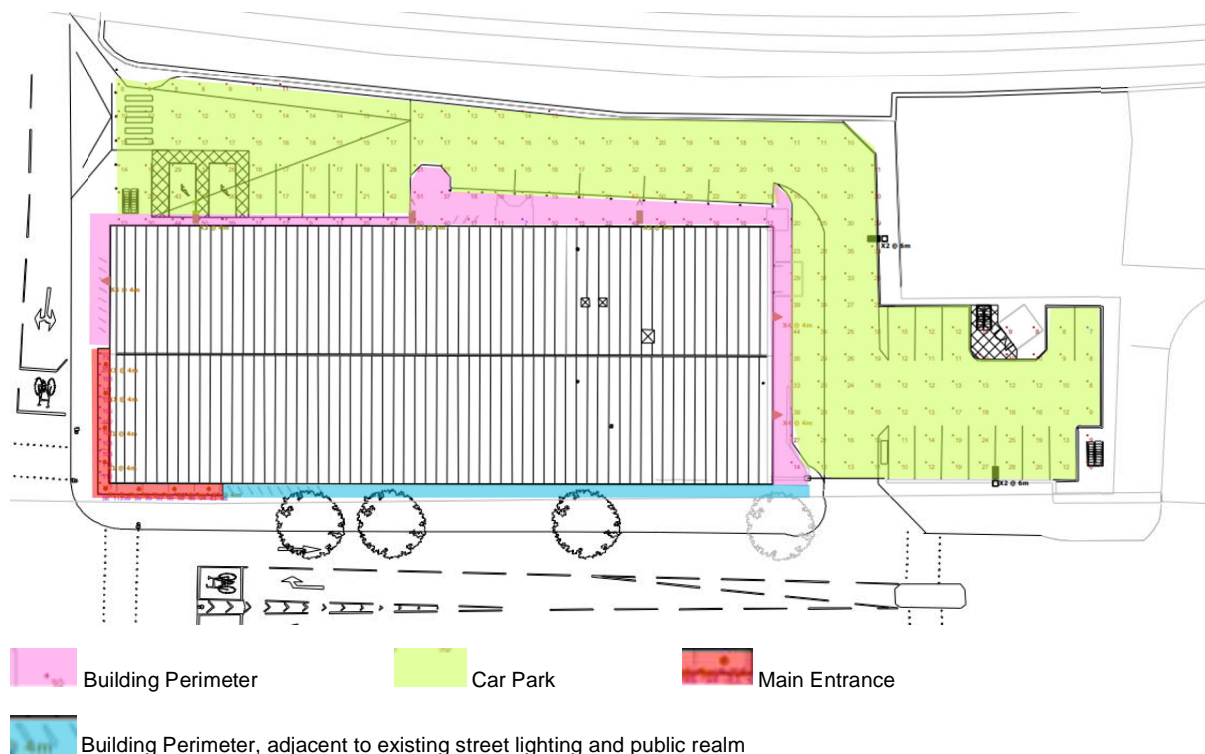

### Technical requirements and design performance

The proposed development will provide a shared surface for pedestrians and vehicles, and lighting is required to support safe use and access of these paved locations.

#### Car Park

Lighting for driving surfaces and parking bays follows the requirements set out in BS 5489-1:2013, Code of practice for the design of road lighting Part 1: Lighting of roads and public amenity areas. Due to the location near Chalk Farm Road and linkage to the existing supermarket, a High traffic outdoor car park has been selected as the design standard. This looks for a 20 lux average and minimum uniformity of 0.25.

The design presented by Holophane introduces an average of 20 lux to the parking area, with a minimum of 7 lux and uniformity of 0.35.

#### Building Perimeter

Building perimeter lighting can have a variable requirement based on the area and what type of security measures are determined to be necessary.

Lighting for driving surfaces and parking bays is expected to follow the requirements set out in BS 12464-2:2014, Lighting of workplaces, Outdoor workplaces. Due to closeness of the building perimeter to the car park and location of proposed lighting, this area will be generally lit to car park levels.

Building perimeter between the proposed Temporary Store and Chalk Farm Road will be lit by existing streetlight and public realm installations. Additional lighting for this section of the facade does not need to be articulated, as the main entrance would for orientation purposes and perimeter illumination is provided by public streetlighting.

## Main Entrance

The Main Entrance to the Temporary Store is located at the junction of Chalk Farm Road and the access road leading to the existing Morrisons car park. This entrance is articulated to aid so that it can be easily recognised and navigated toward.

Lighting of the main entrance is expected to follow the requirements set out in BS 12464-2:2014, Lighting of workplaces, Outdoor workplaces and those provided as part of Morrisons lighting requirements. This looks for a 100 lux average and minimum uniformity of 0.4.

The design presented by Holophane introduces an average of 100 lux to the under-canopy area, with a minimum of 65 lux and uniformity of 0.65.

## Lighting Against Crime requirements

Lighting Against Crime introduces thresholds that are considered to be good lighting approaches and targets for lighting to reduce the opportunity for crime and provide an environment which feels safer. This incorporates designs which utilise an appropriate amount of light, provide good uniformity and limit their impacts in terms of light pollution and energy use. It also advises good vertical illumination for facial recognition and to low level installations.

The Temporary Store is considered to be a public space, where the land is privately owned but the public will have access to it. Recommendations for exterior lighting of public spaces considers that good design will incorporate adequate light levels, good uniformity and low light pollution, an aesthetic appearance, regular maintenance and be made of vandal resistant equipment / materials. Applicable targets associated with public spaces are advised as:

- Pedestrian only traffic – 20 lux
- Urban small short stay car park – 20 lux

Advice is also provided for the use of CCTV and advises that generally a monochrome camera will require a minimum illuminance of at least 5 lux, whereas a colour camera will require at least 15 lux and both with a uniformity of 0.4 or higher. Where a colour camera is used, the colour rendering of the light should be at least rated 60 or higher.

The design presented by Holophane meets or exceeds these requirements.

## Environmental requirements

The Institute of Lighting Professionals (ILP) document GN01 Guidance notes for the reduction of obtrusive light advises that lighting which has the same characteristics as the overall area lighting condition are less likely to cause disturbance, as well as minimise instances of light pollution.

The guidance describes design approaches and different types of brightness characteristics expressed by limiting criteria for obtrusive light. This is done through defining environmental zones which set out the recommended limiting criteria for a new or changed lighting installation.

The local area lighting characteristics have been established to be similar to those associated with a suburban / urban location, ranging between environmental zones E3 and E4. The area that the Temporary Store is located in is considered to have the same characteristics.

## Environmental Target Criteria

The following tables are extracts of ILP GN01 which give an overview toward how brightness characteristics are considered and what targets are recommended. Note that for any criteria indicating a curfew, the curfew is assumed to be around 11pm, or would refer to a time agreed with Camden Council.

**Table 1 – Lighting environmental zones**

Zone	Surrounding	Lighting environment	Examples
E0	Protected	Dark (SQM 20.5+)	Astronomical Observable dark skies, UNESCO starlight reserves, IDA dark sky places
E1	Natural	Dark (SQM 20 to 20.5)	Relatively uninhabited rural areas, National Parks, Areas of Outstanding Natural Beauty, IDA buffer zones etc.
E2	Rural	Low district brightness (SQM ~15 to 20)	Sparsely inhabited rural areas, village or relatively dark outer suburban locations
E3	Suburban	Medium district brightness	Well inhabited rural and urban settlements, small town centres of suburban locations
E4	Urban	High district brightness	Town/city centres with high levels of night-time activity

(extract ILP GN01 2020, Table 2)

**Table 2 – Lighting threshold criteria – Maximum vertical illuminance on properties (light spill)**

Light technical parameter	Application conditions	Environmental zone				
		E0	E1	E2	E3	E4
Illuminance in the vertical plane ( $E_v$ )	Pre-curfew	n/a	2 lx	5 lx	10 lx	25 lx
	Post-curfew	n/a	<0.1 lx*	1 lx	2 lx	5 lx

Note:

\* If the installation is for public (road) lighting then this may be up to 1 lx.

(extract ILP GN01 2020, Table 3)

**Table 3 – Lighting threshold criteria – Limits for luminous intensity (glare)**

Light technical parameter	Application conditions	Luminaire group (projected area $A_p$ in $m^2$ )					
		$0 < A_p \leq 0.002$	$0.002 < A_p \leq 0.01$	$0.01 < A_p \leq 0.03$	$0.03 < A_p \leq 0.13$	$0.13 < A_p \leq 0.50$	$A_p > 0.5$
Maximum luminous intensity emitted by luminaire ( $I$ in cd)	E0						
	Pre-curfew	0	0	0	0	0	0
	Post-curfew	0	0	0	0	0	0
	E1						
	Pre-curfew	0.29 d	0.63 d	1.3 d	2.5 d	5.1 d	2,500
	Post-curfew	0	0	0	0	0	0
	E2						
	Pre-curfew	0.57 d	1.3 d	2.5 d	5.0 d	10 d	7,500
	Post-curfew	0.29 d	0.63 d	1.3 d	2.5 d	5.1 d	500
	E3						
	Pre-curfew	0.86 d	1.9 d	3.8 d	7.5 d	15 d	10,000
	Post-curfew	0.29 d	0.63 d	1.3 d	2.5 d	5.1 d	1,000
E4							
Pre-curfew	1.4 d	3.1 d	6.3 d	13 d	26 d	25,000	
Post-curfew	0.29 d	0.63 d	1.3 d	2.5 d	5.1 d	2,500	
Aid to gauging $A_p$		2 to 5cm	5 to 10cm	10 to 20cm	20 to 40cm	40 to 80cm	>80cm
Geometric mean of diameter (cm)		3.2	7.1	14.1	26.3	56.6	>80
Corresponding $A_p$ representative area ( $m^2$ )		0.0008	0.004	0.016	0.063	0.251	>0.5

(extract ILP GN01 2020, Table 4)

**Table 4 – Lighting threshold criteria – Limits for upward light (sky glow)**

Light technical parameter	Environmental zones				
	E0	E1	E2	E3	E4
Upward light ratio (ULR)/%	0	0	2.5	5	15

*Note:*

This does not take into account the effect of light reflected upwards from ground that also contributes to sky glow. This is the traditional method to limit sky glow and is suitable to compare different single luminaires.

*(extract ILP GN01 2020, Table 6)*

## Energy and Sustainability Criteria

The proposed lighting strategy has been developed having regard to energy efficiency and sustainability principles, including the following planning policy considerations:

- Camden Local Plan - Policy D1, which requires that development must be sustainable in design and construction, incorporating best practice in climate change mitigation and adaptation.
- Camden Planning Guidance: Design states that public realm lighting should avoid unnecessary energy consumption, with intensity of lighting appropriate to its function.

## Lighting Design

The proposed lighting design utilises a mixture of lighting typologies to meet the design criteria for each area. Figure 7 provides an overview of the typologies and locations of proposed new lighting for the Temporary Store in plan, while Figure 8 (a,b) - Figure 9 (a,b) show these locations in elevation.

All lighting is LED high efficiency and subject to a control strategy to avoid unnecessary energy consumption.

Opportunities to re-use the lighting following cessation of the temporary store will be reviewed and set out in a detailed Reuse and Restoration Strategy, in accordance with condition 71 of the planning permission.

Table 5 provides additional information on the equipment specification and installation details.



**Figure 7 – Lighting arrangements, plan view overlay (extract Morrisons Camden Temporary Store External Ltg Rev 2 overlay)**

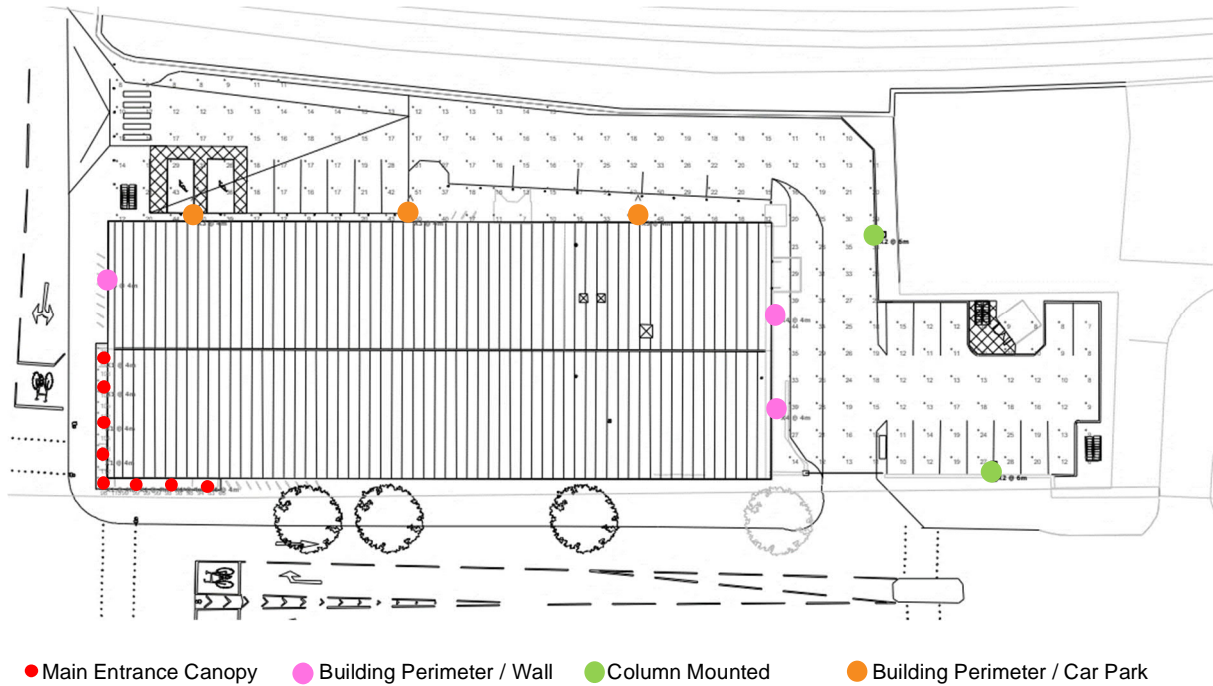



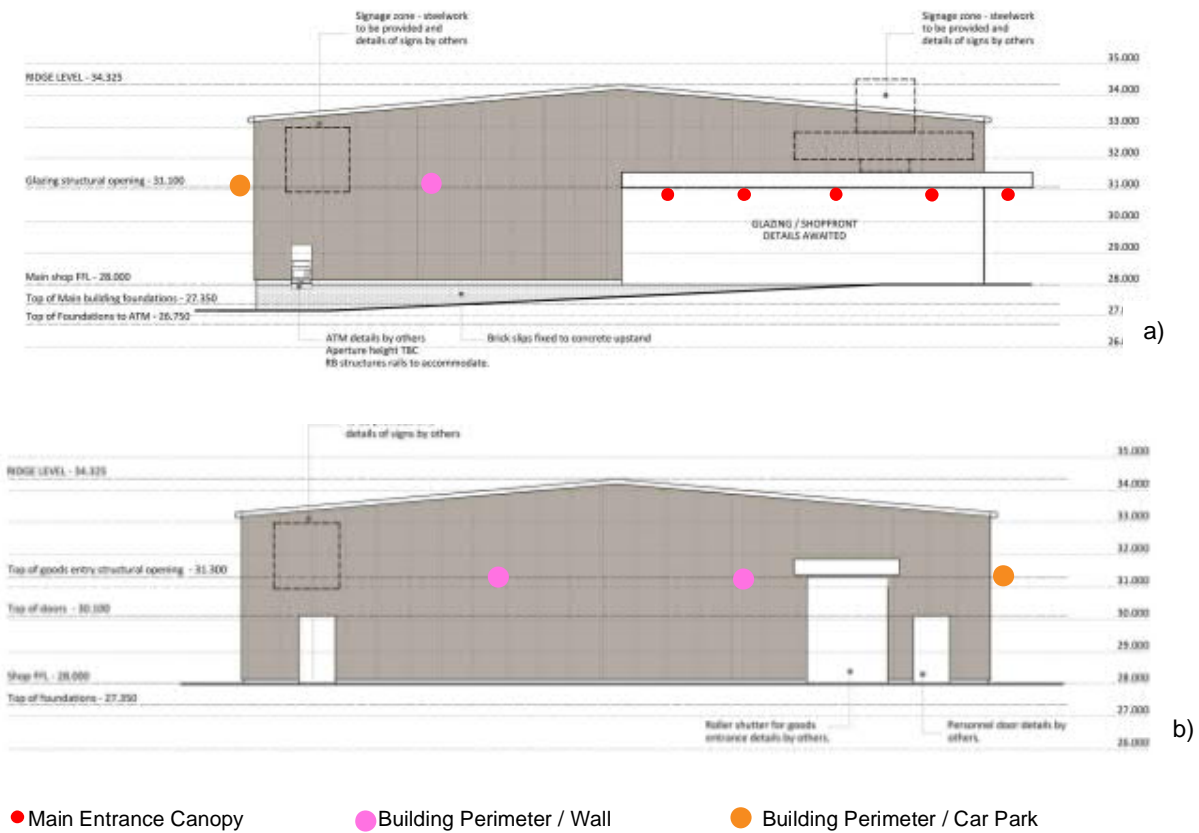

**Figure 8 (a,b) – Lighting arrangements, a) west and b) east elevations overlay (extract building elevations plan 200227-25B, April 2020)**

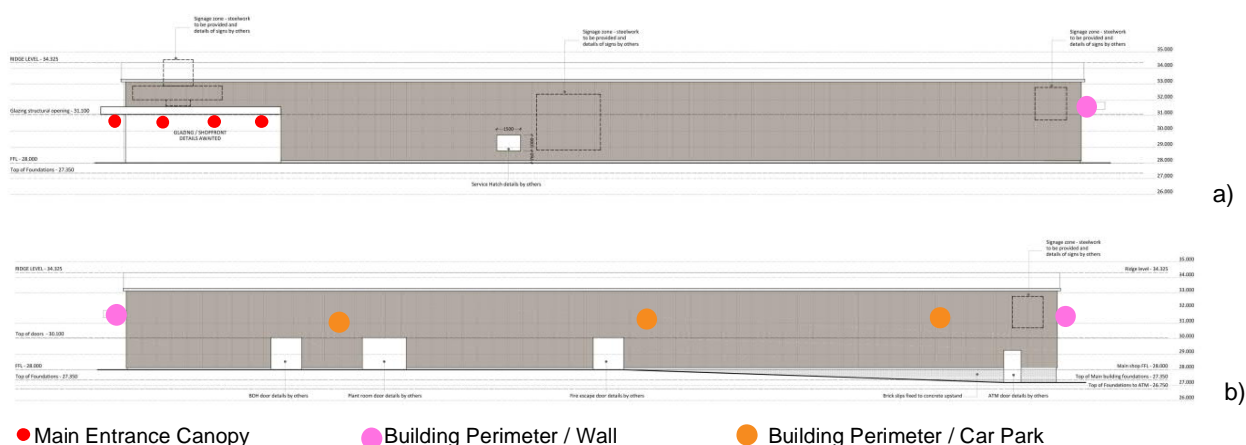

**Figure 9 (a,b) – Lighting arrangements, a) south and b) north elevations overlay (extract building elevations plan 200227-25B, April 2020)**



**Table 5 – Lighting design equipment specification and installation parameters**

Symbol	Image	Product	Lamp	Light Colour	Lumen Output	Installation
●		Circus	LED	4000K (neutral white)	2000	Surface mounted to the underside of the entrance canopy, approximate mounting height at 4m
●		Factor Small with forward throw	LED	4000K (neutral white)	10000	Wall mounted via a bracket at 4m above ground, fitting will be tiled at 5 degrees
●		Factor Small with forward throw	LED	4000K (neutral white)	8000	Post-top mounted to a 6m column
●		Denver Elite Wall with asymmetric optic	LED	4000K (neutral white)	2000	Wall mounted at 4m above ground level

## Lighting Control

Lighting controls will incorporate use of both a photocell and timeclock to suit the trading hours of the store. Usually this would follow a pattern where the lighting would be turned ON for one hour before and after their open hours. Other lighting will be turned OFF outside of this time period.

Store perimeter lighting may stay on for longer periods of time to support safe security measures.

It is expected that external lighting at the building entrance will be turned off when the store is closed, although perimeter / car park lighting may be left on for security or site access during the hours of darkness.

Hours of operation for the Temporary Store are expected to be similar to hours posted for the current main supermarket location: 08.00 – 11.00 Monday – Friday, 07.00 – 23.00 Saturday and 10.00 to 16.00 on Sundays.

## 4. Technical Assessment

Lighting performance was reviewed using DIALux, an industry standard software. Variable screening that might be provided by mature trees or shrubbery is not included within the assessment. It is recognised that there are established trees at the east boundary and between the site and Chalk Farm Road. These would have a limited influence in any case considering they are located toward the perimeter of the site and away from areas being lit from the new lighting design.

Figure 10 and Figure 11 show the simulated performance for the Holophane external lighting design and strategy in white light and false colour, respectively. The graphics show the way light is distributed on the ground and other surfaces from all new exterior lighting associated with the proposed Temporary Store.

The false colour render is provided on a scale of 0 – 25+ lux for ease of reading, where the 25 lux threshold is the recommended maximum that might fall onto windows which are typically residential.

**Figure 10 - Simulated lighting performance – white light graphic**

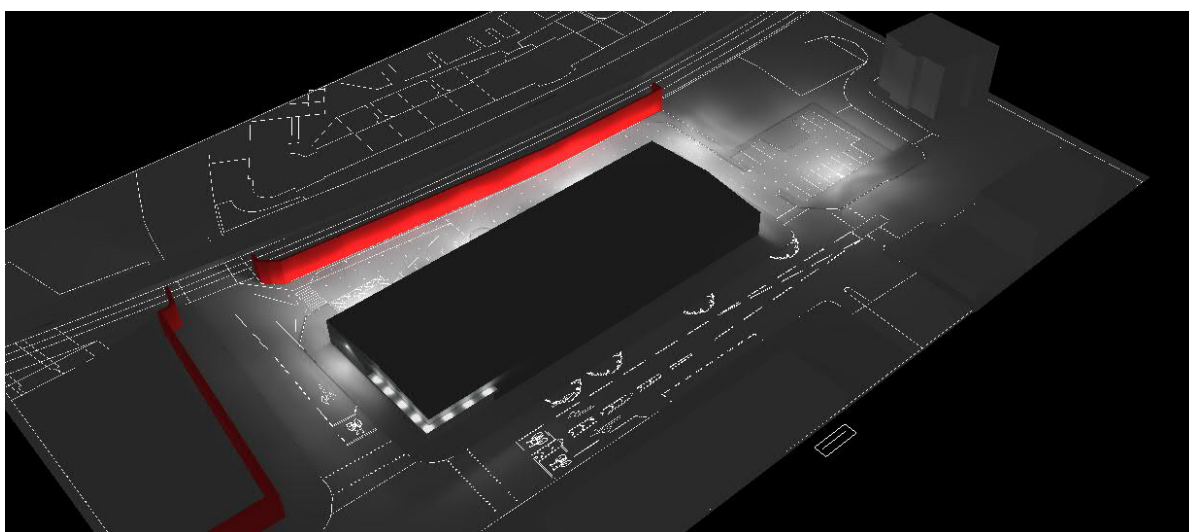

**Figure 11 - Simulated lighting performance – false colour graphic in lux**

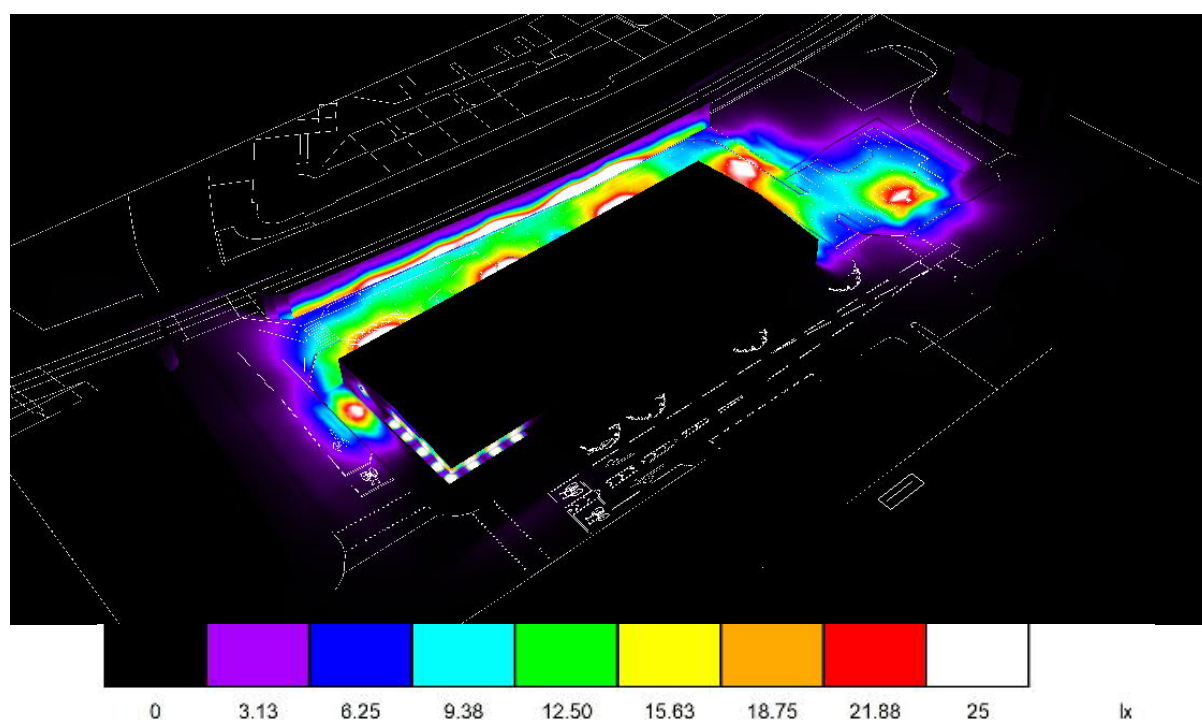

## Maintenance and Maintenance Factor

Maintenance considers guidance provided by BS 5489-1:2013. A maintenance factor of 0.8 was used to represent a less than 3 year assumed cleaning cycle and commitment to regular inspection and upkeep of exterior lighting, to include replacement where necessary in case of lamp failure, so that the lighting condition will be consistent for the time it is used. This incorporates the likely influence of the type of lighting character that has been identified for the site to allow for environmental influence on the performance of exterior lighting over time suitable for an environmental zone E4.

The simulation images reflect this performance. Please note that day 1 conditions are usually brighter, but this can be controlled by using a constant current system that adjusts to provide a consistent light output over time.

## Simulated Lighting Performance

The lighting design provided by Holophane for external lighting has been assessed for light spill, sky glow and glare which might result from new lighting associated with the Morrisons Camden Temporary Store. New lighting will be introduced in an already lit location which provides light to the petrol filling station, forecourt and access routes to / from and through the site.

### Light spill

There are no existing windows which are affected by an increase in light spill created by the proposed lighting design and so good practice light spill criteria are met.

A small amount of spill may occur where paving is close to the site boundary, but the levels are minimal and will not interfere with public streetlighting.

There are no recorded light sensitive ecological interests immediate to the site as it sits within a highly developed area and no roosts are within the sites or local area that would be affected. There is a low to moderate potential for commuting and foraging to the south of the site, however due to the current condition already being lit and the relative distance of the site to these routes are unlikely to be affected.

Less than 1 lux may reach the side of the elevated structure where the structure is not screened by nearby brick walls, but this does not contribute light above the height of that structure and train drivers would be unaffected. This would also not create a visual conflict with signals.

### Sky glow

There is no light found to shine directly into the sky from the proposed installation and so good practice sky glow criteria are met.

The lighting design incorporates design measures which inherently limit upward light. This includes:

- Selection of full cut-off lighting which does not shine light directly above the horizontal;
- Directing light down through installing new lighting with minimal to no tilt; and
- Selection of lighting equipment which does not contribute to over lighting.

### Glare

There are no existing windows which are affected by new glare from the proposed lighting design and so good practice glare criteria are met.

Glare points were set above the level of the elevated rail at an approximate driver eye height. No lighting is oriented so that the light source directly shines toward at elevated rail or above and no glare is created by visible lamps.

It is expected that the proposed design will improve on the lit performance of the site which utilises an older style of fitting and technology. Additionally, the proposed lighting will be introduced in an area which is already lit, so small moments of brightness which may be visible below a standard field of view will not create significant contrast in the driver's line of sight. This would also not create a visual conflict with signals.

## 5. Summary

The Morrisons Camden Temporary Store has a requirement for exterior lighting for the safe access and use of the site by visitors, employees and vendors. The external areas are all publicly accessible, so lighting is designed to aid transition to public realm areas.

An external lighting strategy has been developed for the Temporary Store by Holophane for illumination of the main entrance, building perimeter and car park. Please note that while light is provided to the building perimeter, this is a side effect of its location and does not constitute façade illumination. Energy use, required maintenance and design performance have informed whole life cycle costs considered as part of design development. Key points of the design are summarised as:

- The external lighting design has been prepared following WMS standard model design principles, and to provide a safe and secure environment for customers and colleagues. All luminaires have a 4000K colour temperature to provide for high visibility for the CCTV system.
- All lighting is high efficiency LED and selected to minimise overspill outside the required area of illumination.
- All lighting is designed in accordance with BS 5489:2013 and recommendations provided by ILP good practice.

The lighting design provides the minimum amount of light to exterior spaces to achieve required light levels without overlighting, aligning to Camden Planning Guidance: Design. The sustainability of the design and construction has been incorporated into the lighting design strategy development, aligning to Camden Local Plan Policy D1.

The proposed design is found to meet or exceed recommendations for secure lighting of public spaces as set out within the Secure by Design document Lighting Against Crime by providing required light and supporting good vertical visibility from building and column mounted lighting.

The proposed design is expected to meet the criteria set out within the ILP GN01 good practice guidance for a lighting zone E4 for light spill, sky glow and glare for both pre and post curfew conditions. Where unneeded lighting is turned off when the store is closed, any operational effects will be reduced.

There are no immediate windows to the site which could be affected by the change in lighting condition and new lighting is not found to create a light spill or glare impact to residential or commercial / retail buildings.

There are no immediate environmental interests to the site and due to the distance and existing lit condition of the site, new lighting is not found to create an impact on foraging or commuting routes to the south.

The proposed installation utilises fittings with optical control that limits contribution of direct upward light through the selection of fittings and method of installation and is not found to contribute direct light to sky glow.

New lighting associated with the Temporary Store as presented is not found contribute to light spill, direct views of light sources or high contrast in the area of the elevated rail which could impair driver eyesight or visibility of signals. It is also worth noting again that the current site is illuminated, and a new lighting installation is expected to be similarly perceived.

The proposed design is found to limit its effects to the area immediate to it and it is unlikely to contribute to significant obtrusive effects.

# Appendix A Lighting Design

Holophane - Lighting Layout Drawing (full)

Holophane - Lighting Equipment Data Sheets

Symbol	Label	Quantity	Catalog Number	Description	Lamp	Wattage
	X1	8	PBHD.CIR.4520568.06	CIRCUS - Surface mounted circular downlight c/w opal diffuser. Cool White 4000K LED's	LED 2000 Lm 4000K	18.3
	X2	2	F.TS.3.LA104.FW	FACTOR SMALL c/w 10,000 Lm output and FW Forward Throw optic on 6m Column	LED C.10000LM-4000K	78
	X3	3	F.TS.2.LA084.FW	FACTOR SMALL c/w 8,000 Lm output and FW Forward Throw optic wall mounted at minimum 4m AGL. Wall bkt to have 5 degree up tilt	LED C.8000LM-4000K	67
	X4	3	DEW.LA024.AY.CGL	Denver Elite Wall c/w 2,000 Lm output and AY optic. Wall mounted at approx 4m AGL	LED C.2000LM - 4000K	23.2

Statistics				
Description	Symbol	Avg	Min	Min/Avg
Parking Area 20 Lux Ave	+	20 lux	7 lux	0.35
Under Canopy	+	100 lux	65 lux	0.65

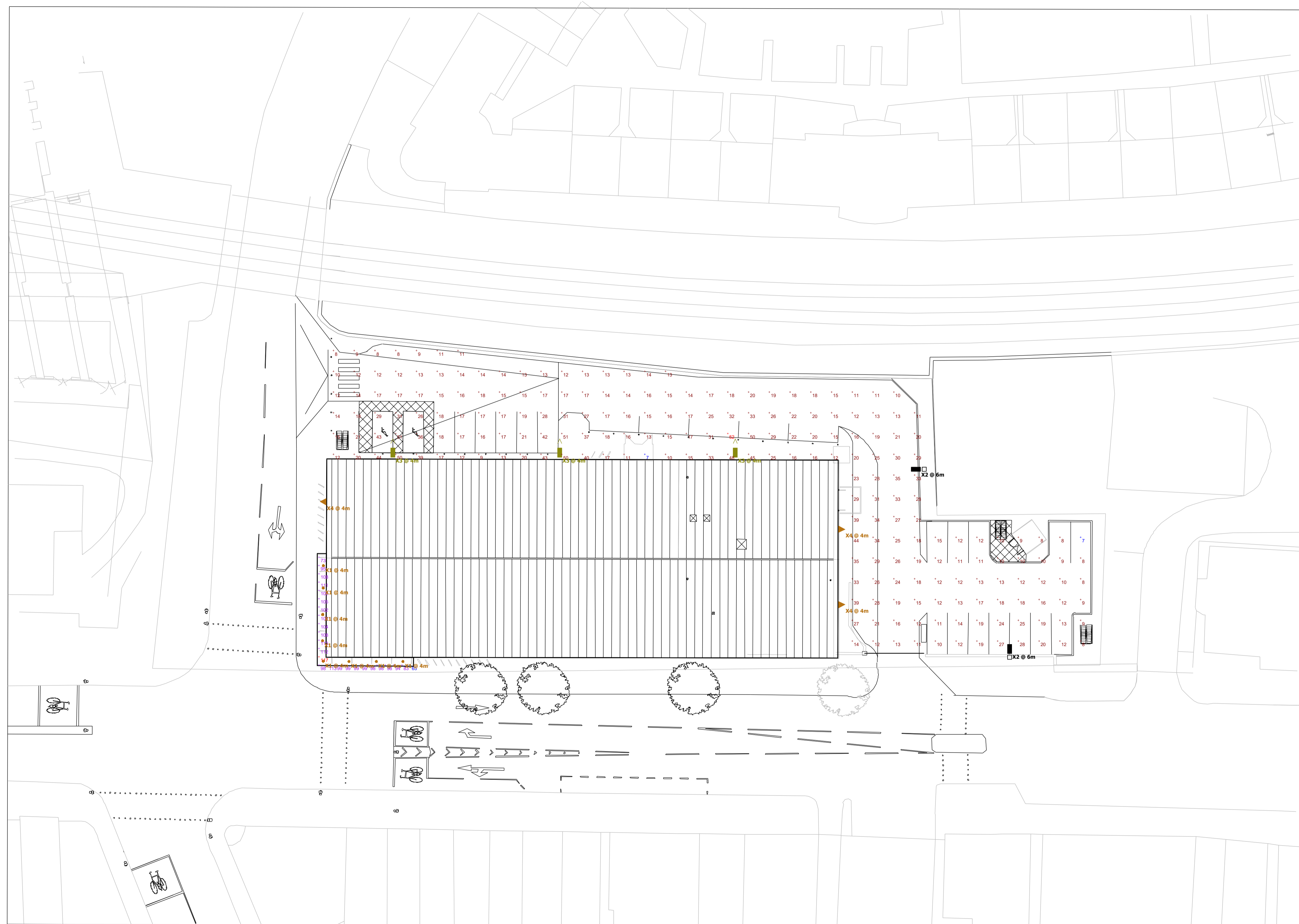

Plan View  
Scale - 1 : 250

Morrisons Camden  
Temporary Store  
External Ltg  
Rev 2

Designer  
Alan Nicholson  
Date  
27/03/2020  
Scale  
1 : 250 @ A1  
Drawing No.  
Rev 2  
Summary



**AcuityBrands.**  
Expanding the boundaries of lighting™



**FACTOR™**  
**FACTOR™**  
SMALL

**factor™ & factor™ small**



# FACTOR™

# FACTOR™

SMALL



Optical Performance  
Heat Management  
Long System Life  
Reduced Maintenance





**FACTOR™** and **FACTOR™ Small** from Holophane, are dedicated LED luminaires that deliver a variety of efficient lumen per watt packages with excellent optical performance. With their precision engineered optics and sleek body design - perfect for dissipating heat away from the LEDs and extending the luminaire life, FACTOR & FACTOR Small give the complete cost saving solution for street lighting environments. With a range of delivered lumen packages equivalent from 35W to 150W ceramic metal halide lamps, FACTOR & FACTOR Small deliver efficient sustainable lighting solutions that have the flexibility to meet today's and tomorrow's lighting requirements.

FACTOR & FACTOR Small's design ensures cool operation that keeps it running for the long haul.

**optics / light source**

- > Lumen package of between 2000 - 17000 lumens
- > Three lighting distribution options

**applications**

- > S-Class, ME-Class, Pedestrian Areas, Residential Areas and Car Parks

**approvals**

- Complies with EN60598
- CE
- IP65 light engines
- TA: Rated for -40°C to 40°C

For further information please visit the Holophane website [www.holophane.co.uk](http://www.holophane.co.uk)

**Typical Luminaire Performance**

Configuration	Delivered Lumens	Power Consumption	Drive Current	Rated Life of LED Module (L70B50 @Tq 15°C)*
<b>FACTOR</b>				
FTR.LA144	c. 14000	97W	525mA	100,000+ hrs
FTR.LA174	c. 17000	130W	700mA	100,000+ hrs
<b>FACTOR Small</b>				
FTS.2.LA02X	c. 2000	17W	525mA	100,000+ hrs
FTS.2.LA03X	c. 3000	23W	700mA	100,000+ hrs
FTS.3.LA05X	c. 5000	35W	525mA	100,000+ hrs
FTS.2.LA06X	c. 6000	47W	700mA	100,000+ hrs
FTS.3.LA09X	c. 9000	66W	1050mA	100,000+ hrs
FTS.3.LA10X	c. 10,000	78W	1225mA	100,000+ hrs
FTS.2.LA07X	c. 7000	52W	525mA	100,000+ hrs
FTS.2.LA084	c. 8000	70W	700mA	100,000+ hrs
FTS.3.LA11X	c. 11000	82W	850mA	100,000+ hrs
FTS.2.LA12X	c. 12000	100W	1050mA	100,000+ hrs

**Note:** Data is correct at time of print.

\* For other life metric data in line with IEC PAS62722-2-1 and 62717 contact your Holophane Representative for details.



Two sizes to deliver a variety of lumen packages



Tool less trigger latch entry



10 LED Board – LA024 & LA034 versions

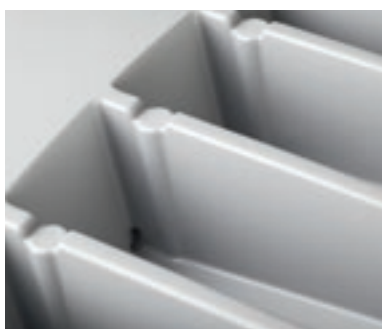

External fins to dissipate heat

## specification

The 'finned' luminaire body, designed to dissipate heat, is manufactured from high pressure die cast aluminium that conforms to EN1706 AC-46500. A die cast aluminium door with tool less trigger latch allows access to the gear compartment concealing the IP65 control gear and connectors. The IP65 LED optical modules, with individual lenses, are mounted directly to the cast aluminium housing and wired in series. A thermal transfer interface is sandwiched between the LED module(s) and high grade aluminium housing to transfer heat away from the LEDs and dissipate through the 'finned' housing for cooling. FACTOR & FACTOR Small have been specifically designed for side entry mounting suitable for 42mm side entry. Option of 60mm version is available with code .SE60.

## features and benefits

Sleek Design with tool-less access

- > FACTOR & FACTOR Small's diecast aluminium housing acts as its primary heat sink. Its longitudinal fins employ conductive cooling techniques to dissipate heat away from the key LED components and extend luminaire life.
- > A die-cast trigger latch allows easy tool less access into the luminaire during installation and maintenance visits.

## Exceptional Performance

- > Offering four lumen packages ranging from 2000lm to 17000lm with efficiencies of up to 139lpw (Lumens Per Watts).
- > Two optimised roadway distributions (asymmetric, forward throw and long & narrow) delivered by quality LEDs and bespoke UV stabilised optics
- > LED light engines with 0% ULOR ensuring night time friendly.

## Fully Maintainable Performance

- > Single tool-less latch access to the luminaire ensures straightforward entry to the luminaire at installation and maintenance.
- > Unique IP65 rated LED light engines that are interchangeable ensuring a futureproof and maintainable LED luminaire.

## Factor (FTR)



dimensions in mm

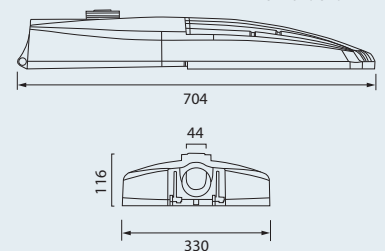

Factor is suitable for 42mm side entry as standard. The option of 60mm side entry is available with option code .SE60.

## Factor Small (FTS)

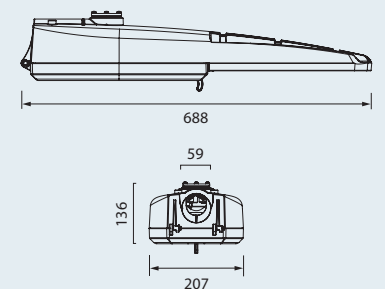

Factor Small is suitable for 42mm side entry as standard. The option of 34mm or 60mm side entry is available with option codes .SE34 or .SE60.

## light distribution

Asymmetric

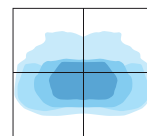

Forward Throw

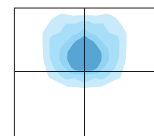

Long & Narrow

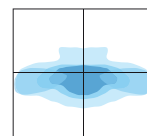

## weight

Factor	12.0 kg
Factor Small	7.0 kg

## windage (effective projected area)

Factor	0.084 m <sup>2</sup>
Factor Small	0.071 m <sup>2</sup>

**Note:** The specifications of the Holophane luminaire and columns represents typical values. All descriptions, illustrations, drawings and specifications in the Holophane catalogue and website represent only general particulars of the goods to which they apply and shall not form part of any contract. The company reserves the right to change specifications at its discretion without prior notification or public announcement.

**Factor (FTR)**



**Typical spacing**

36m spacing mounted at 6m

**typical spacing**

- > Designed to S4, BSEN13201 P2, 2003
- > 6m mounting height, 2 lanes, 10m road width with 2m setback.
- > Achieving 36m max spacing with 0.22 uniformity.

**Factor Small (FTS)**



**Typical spacing**

32m spacing mounted at 6m

**typical spacing**

- > Designed to S4, BSEN13201 P2, 2003
- > 6m mounting height, 2 lanes, 10m road width with 2m setback.
- > Achieving 32m max spacing with 0.25 uniformity.



## ordering details : luminaire

Code	
FTR	Factor Luminaire
<b>Code</b>	<b>Lamp Type</b> (required)
.LA144	LED light engine producing c.14,000 lm with a nominal 4000°K colour temperature
.LA174	LED light engine producing c.17,000 lm with a nominal 4000°K colour temperature
<b>Code</b>	<b>Light Distribution</b> (required)
.SY	Symmetrical
.AY	Asymmetric
.FW	Forward Throw
.NR	Long and Narrow
<b>Code</b>	<b>Colour</b> (required)
.C1	White (RAL9016)
.C4	Graphite (RAL7011)
.C6	Grey (RAL7035)
.C7	Black (RAL9005)
.C9	Metallic Silver (RAL9006)
.RAL****	(customer choice)
<b>Code</b>	<b>Options</b>
.T1	Complete with NEMA socket. (To accept standard NEMA Photocell, available from Holophane)
.TSZ	Complete with miniature 70 lux factory fitted photocell. (Zodion SS12)
.TSZA	Complete with miniature 55 lux factory fitted photocell. (Zodion SS12A)
.TSZB	Complete with miniature 35 lux factory fitted photocell. (Zodion SS12B)
.T5	Complete with 5-pin dimming NEMA ANSI C136.41 socket (suitable photocell/node supplied by others) without locking top
.T7	Complete with 7-pin dimming NEMA ANSI C136.41 socket (suitable photocell/node supplied by others) without locking top
.T5T	Complete with 5-pin dimming NEMA ANSI C136.41 socket (photocell/node supplied by others) with weather proof locking top
.T7T	Complete with 7-pin dimming NEMA ANSI C136.41 socket (photocell/node supplied by others) with weather proof locking top
<b>Code</b>	<b>Fixing Method</b> (optional)
.SE60	60mm side entry mounting
<b>Code</b>	<b>Control Gear</b> (optional)
.CL7	Programmed to deliver 70% of the initial lumens over the life of the luminaire
.CL8	Programmed to deliver 80% of the initial lumens over the life of the luminaire
.CL9	Programmed to deliver 90% of the initial lumens over the life of the luminaire
.D2	DALI HF electronic control gear
<b>Code</b>	<b>Dimming Outputs</b> (optional)
.LRT56	pre-set to dim to 50% between 12am to 6am
.LRT66	pre-set to dim to 60% between 12am to 6am
.LRT76	pre-set to dim to 70% between 12am to 6am
<b>Code</b>	<b>Cable Entry</b> (optional) max length catered for
.FF10S	10 metres of 1.5mm <sup>2</sup> 3 core cable "flex" for side entry mounting
.FS10S	10 metres of flat twin & earth 2.5mm <sup>2</sup> for side entry mounting
.F510S	10 metres of 1.5mm <sup>2</sup> 5 core cable "flex" for side entry mounting
<b>Example</b>	FTR .LA144 .AY .C1 .TSZ .SE60 .CL7 .LRT56 .FF10S

Lumen data is considered to be representative of the configuration shown, and may vary, with a tolerance on flux of +/- 7% (typical of LED manufacturers data) and luminaire power of +/- 5%.

**Code**

FTS	Factor Small								
<b>Code</b>	<b>Prefix (optional)</b>								
.2	Series 2								
.3	Series 3								
<b>Code</b>	<b>Lamp Type (required)</b>								
.LA024	LED light engine producing c.2,000 lm with a nominal 4000K colour temperature								
.LA034	LED light engine producing c.3,000 lm with a nominal 4000K colour temperature								
.LA054	LED light engine producing c.5,000 lm with a nominal 4000K colour temperature*								
.LA064	LED light engine producing c.6,000 lm with a nominal 4000K colour temperature								
.LA074	LED light engine producing c.7,000 lm with a nominal 4000K colour temperature								
.LA084	LED light engine producing c.8,000 lm with a nominal 4000K colour temperature								
.LA094	LED light engine producing c.9,000 lm with a nominal 4000K colour temperature								
.LA104	LED light engine producing c.10,000 lm with a nominal 4000K colour temperature*								
.LA114	LED light engine producing c.11,000 lm with a nominal 4000K colour temperature*								
.LA124	LED light engine producing c.12,000 lm with a nominal 4000K colour temperature								
.LA023	LED light engine producing c.2,000 lm with a nominal 3000K colour temperature								
.LA033	LED light engine producing c.3,000 lm with a nominal 3000K colour temperature								
.LA053	LED light engine producing c.5,000 lm with a nominal 3000K colour temperature*								
.LA063	LED light engine producing c.6,000 lm with a nominal 3000K colour temperature								
.LA073	LED light engine producing c.7,000 lm with a nominal 3000K colour temperature								
.LA083	LED light engine producing c.8,000 lm with a nominal 3000K colour temperature								
.LA093	LED light engine producing c.9,000 lm with a nominal 3000K colour temperature								
.LA103	LED light engine producing c.10,000 lm with a nominal 3000K colour temperature*								
.LA113	LED light engine producing c.11,000 lm with a nominal 3000K colour temperature*								
.LA123	LED light engine producing c.12,000 lm with a nominal 3000K colour temperature								
<b>Code</b>	<b>Light Distribution (required)</b>								
.SY	Symmetrical								
.AY	Asymmetric								
.FW	Forward Throw								
.NR	Long and Narrow								
<b>Code</b>	<b>Colour (required)</b>								
.C1	Smooth White (RAL9016)								
.C4	Graphite (RAL7011)								
.C6	Grey (RAL7035)								
.C7	Black (RAL9005)								
.C9	Metallic Silver (RAL9006)								
.RAL****	(customer choice)								
<b>Code</b>	<b>Options</b>								
.T1	Complete with NEMA socket. (To accept standard NEMA Photocell, available from Holophane)								
.TSZ	Complete with miniature 70 lux factory fitted photocell. (Zodion SS12)								
.TSZA	Complete with miniature 55 lux factory fitted photocell. (Zodion SS12A)								
.TSZB	Complete with miniature 35 lux factory fitted photocell. (Zodion SS12B)								
.T5	Complete with 5-pin dimming NEMA ANSI C136.41 socket (photocell/node supplied by others) without locking top								
.T7	Complete with 7-pin dimming NEMA ANSI C136.41 socket (photocell/node supplied by others) without locking top								
.T5T	Complete with 5-pin dimming NEMA ANSI C136.41 socket (photocell/node supplied by others) with weather proof locking top								
.T7T	Complete with 7-pin dimming NEMA ANSI C136.41 socket (photocell/node supplied by others) with weather proof locking top								
<b>Code</b>	<b>Fixing Method (optional)</b>								
.SE60	60mm side entry mounting								
.SE34	34mm side entry mounting								
<b>Code</b>	<b>Control Gear (optional)</b>								
.CL7	Programmed to deliver 70% of the initial lumens over the life of the luminaire								
.CL8	Programmed to deliver 80% of the initial lumens over the life of the luminaire								
.CL9	Programmed to deliver 90% of the initial lumens over the life of the luminaire								
.D2	DALI HF electronic control gear								
<b>Code</b>	<b>Dimming Outputs (optional)</b>								
.LRT56	pre-set to dim to 50% between 12am to 6am								
.LRT66	pre-set to dim to 60% between 12am to 6am								
.LRT76	pre-set to dim to 70% between 12am to 6am								
<b>Code</b>	<b>Cable Entry (optional) max length catered for</b>								
.FF10S	10 metres of 1.5mm <sup>2</sup> 3 core cable "flex" for side entry mounting								
.FS10S	10 metres of flat twin & earth 2.5mm <sup>2</sup> for side entry mounting								
.F510S	10 metres of 1.5mm <sup>2</sup> 5 core cable "flex" for side entry mounting								

**Example** FTS .2.LA024 .AY .C1 .T1 .SE60 .CL7 .LRT56 .FF10S

**Note:** Factor and Factor Small are offered with 42mm side entry as standard. \* Only available with Series 3 (.3)

Lumen data is considered to be representative of the configuration shown, and may vary, with a tolerance on flux of +/- 7% (typical of LED manufacturers data) and luminaire power of +/- 5%.

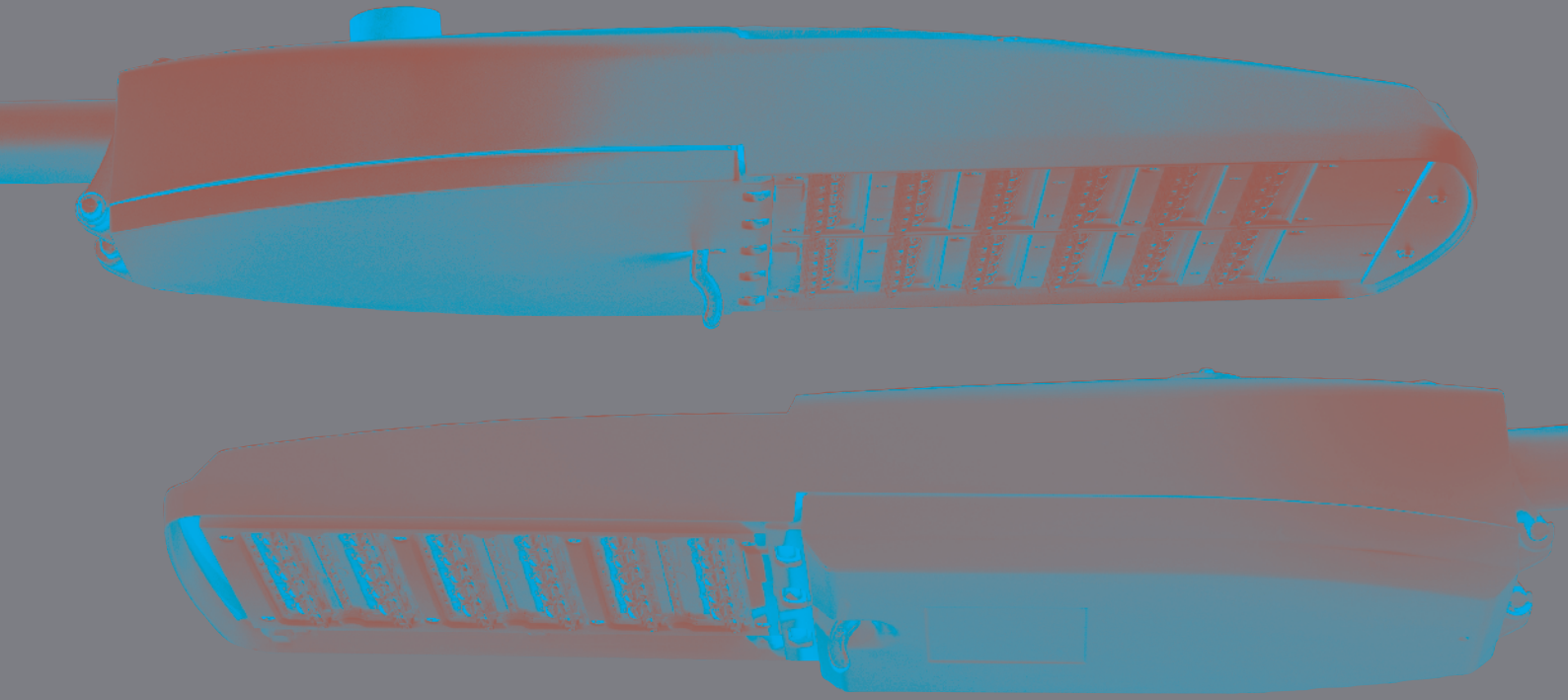

# FACTOR™

# FACTOR™ SMALL

Holophane Europe Limited  
Bond Avenue, Bletchley, Milton Keynes MK1 1JG United Kingdom  
Telephone: +44 (0) 1908 649292 UK Fax: +44 (0) 1908 367618  
International Fax: +44 (0) 1908 363789  
E-mail: [info@holophane.co.uk](mailto:info@holophane.co.uk)

[www.holophane.co.uk](http://www.holophane.co.uk)





**HOLOPHANE®**

**AcuityBrands.**

Expanding the boundaries of lighting™



THE QUEEN'S AWARDS  
FOR ENTERPRISE:  
INNOVATION  
2017



**DENVER™**  
elite system



**wall**

**DENVER™**  
elite system



**denver™ elite wall**

REGISTERED EUROPEAN DESIGN





# DENVER™ elite system



The **Denver™ Elite Pole** exterior lighting luminaire joins the popular 'Denver™ Elite' family of lighting products. This family of products shares the same registered form to give designers flexibility in exterior lighting schemes.

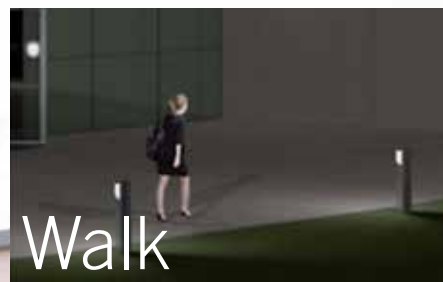

View the animated version at [www.holophane.co.uk/denverelitefamilyanimation](http://www.holophane.co.uk/denverelitefamilyanimation)

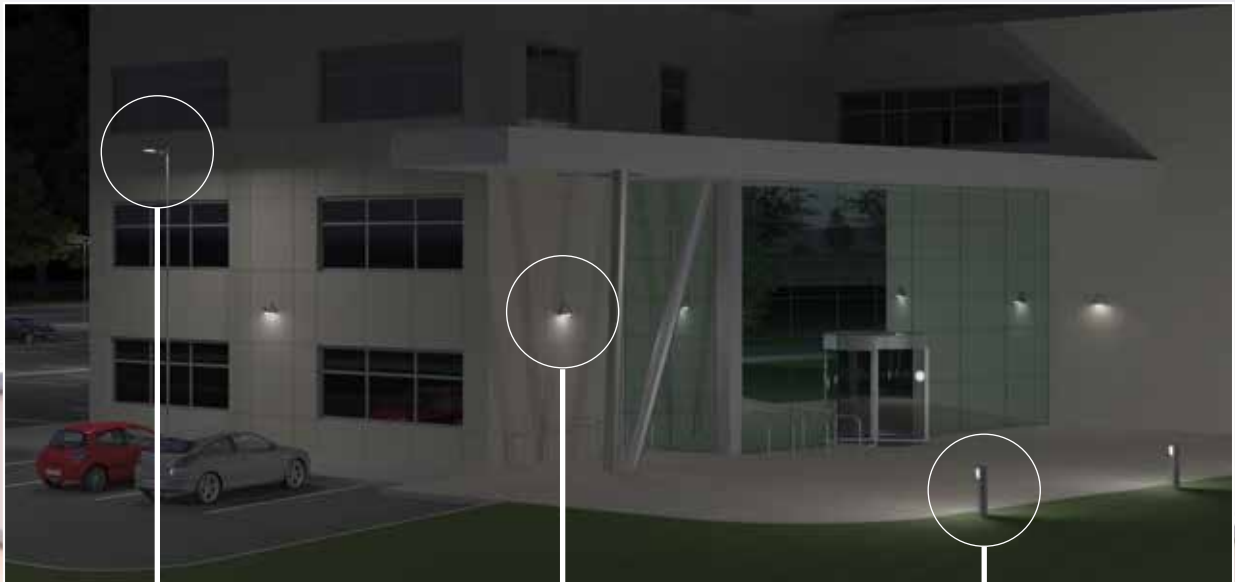

**Denver™ Elite Pole**

A fusion of contemporary styling and dynamic design, developed with the latest technology. The Denver™ Elite Pole completes the family range of luminaires.

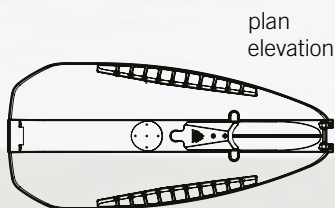

plan elevation



**Denver™ Elite Wall**

The design keeps the trilobular profile associated with the Denver™ Elite family and is a progression of everything learnt from our existing wall mounted products whilst taking new technologies and environmental issues into consideration.

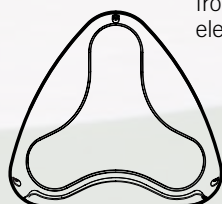

front elevation

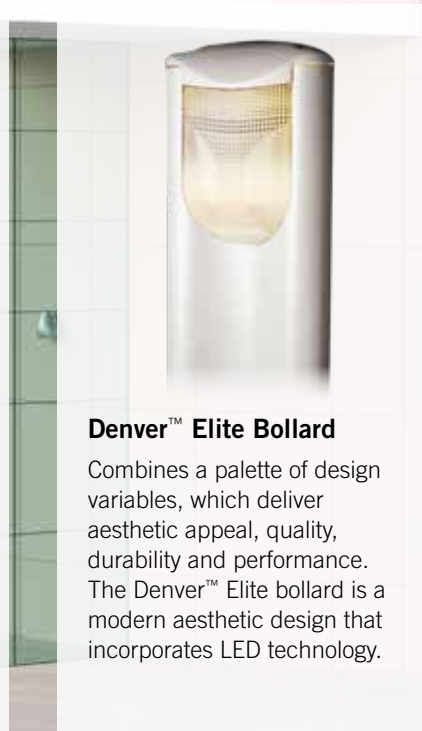

**Denver™ Elite Bollard**

Combines a palette of design variables, which deliver aesthetic appeal, quality, durability and performance. The Denver™ Elite bollard is a modern aesthetic design that incorporates LED technology.

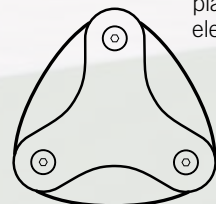

plan elevation

DENVER™  
elite system

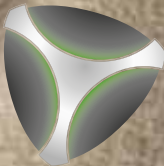

---

wall

A modern aesthetic design that  
incorporates LED technology

denver™ elite wall



The **Denver™ Elite Wall** combines aesthetic appeal, quality, durability and performance.

The Denver™ Elite wall is a modern aesthetic design that incorporates LED technology. With its stylised design and prismatic glass optic, providing a high performance asymmetric distribution, with wide spacings and high efficiency. This makes the Denver™ Elite Wall an industry leading wall mount product.

The design keeps the trilobular profile associated with the Denver™ Elite family and is a progression of everything we've learnt from our existing wall mounted products whilst taking new technologies and environmental issues into consideration.

#### optics / light source

> 1000 - 3000 lumen package LED options

#### approvals

IP65  
EN60598  
CE

For further information please visit the Holophane website  
[www.holophane.co.uk](http://www.holophane.co.uk)



#### typical luminaire performance

Configuration	Delivered Lumens†	Power Consumption	Drive Current	Rated Life of LED Module (L70B50 @Tq 20°C)*
.LA01X	c. 1,000	12W	350mA	100,000 hours
.LA02X	c. 2,000	24W	700mA	100,000 hours
.LM014	c. 1,000	17W	350mA	73,000 hours
.LM024	c. 2,000	22W	500mA	75,000 hours
.LM034	c. 3,000	31W	700mA	70,000 hours

**Note:** Data is correct at time of print.

\* For other life metric data in line with IEC PAS62722-2-1 and 62717 contact your Holophane Representative for details.

† Based on the average of all the optical distribution options.



REGISTERED EUROPEAN DESIGN



External ribs on the housing to allow air flow and ensure cool running of electronic control gear.



Photocell option



Cable 'Knock Out' points allow simple and flexible installation and through wiring.

## specification

The luminaire shall consist of a high pressure LM6 die-cast aluminium body, with integrated thermal management design. Denver™ Elite Wall incorporates an LED driver suitable for LED technology sources. The optical arrangement consists of an aluminium internal reflector and a prismatic glass lens providing an asymmetric distribution. Three stainless steel screws maintain uniform compression on a closed cell silicon gasket to ensure an IP65 rating at all times. The luminaire shall be suitable for wall mounting with rear, top, side and through wiring options via 20mm Ø knockout cable entry/exit points. Denver™ Elite Wall complies with the requirements of EN60598 with a choice of additional options and accessories.

## applications

Frontages, Building Perimeters, Amenity Areas Walkways, Passage Ways, Precincts

## light distribution

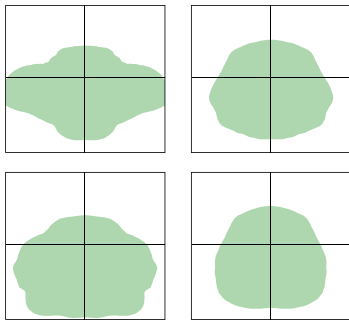

## weight & thermal data

Lamp Type	Weight (kg)	Min. Operating Temperature (°C)	Max. Ambient Temperature (°C)
LA01X	6.4	TBC	40
LA02X	6.4	TBC	40
LM014	6.4	-25	40
LM024	6.4	-25	40
LM034	6.4	-25	40

\*The maximum ambient temperatures stated are for exterior use only. For interior use deduct 10°C from the temperature stated.

## features and benefits

### Contemporary styling

- > Unique 'registered' trilobular design giving an aesthetic appeal that complements today's modern architecture and continues the Denver™ Elite family range

### High quality construction

- > Durability ensured by a high pressure die cast LM6 aluminium housing and glass optic.
- > The housing is designed to include thermal management features.
- > Designed to IP65 to provide a fully weather sealed rating.

### Optional photocell

- > Photocell option discretely designed into the casting to ensure clean aesthetics.

### Flexibility during installation

- > A variety of improved cable 'knock-out' points allow simple and flexible installation and through wiring.

### Emergency options

- > Available LED.

### Low ULOR option available

- > LED version has circa <3% ULOR as standard.

### Vandal resistant

- > Robust design and construction offering a vandal resistant product.



dimensions in mm

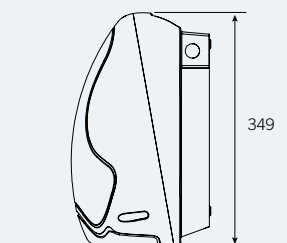
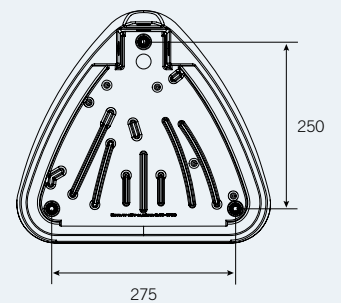
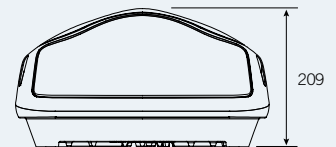
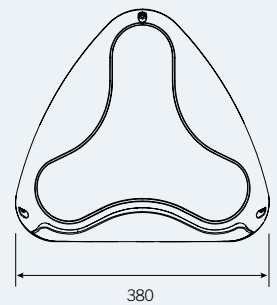
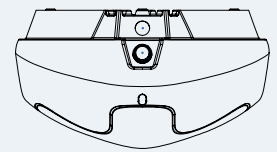

**Note:** The specifications of the Holophane luminaire and columns represents typical values. All descriptions, illustrations, drawings and specifications in the Holophane catalogue and website represent only general particulars of the goods to which they apply and shall not form part of any contract. The company reserves the right to change specifications at its discretion without prior notification or public announcement.

## ordering details

To find out more  
please visit  
[www.holophane.co.uk](http://www.holophane.co.uk)

### Code

DEW Denver™ Elite Wall

<b>Code</b>	<b>Lamp Type</b> (required)	
.LA013	LED light engine producing c.1000 lm with a nominal 3000K colour temperature	
.LA014	LED light engine producing c.1000 lm with a nominal 4000°K colour temperature	
.LA023	LED light engine producing c.2000 lm with a nominal 3000K colour temperature	
.LA024	LED light engine producing c.2000 lm with a nominal 4000°K colour temperature	
.LM014	LED light engine producing c.1000 lm with a nominal 4000°K colour temperature	
.LM024	LED light engine producing c.2000 lm with a nominal 4000°K colour temperature	
.LM034	LED light engine producing c.3000 lm with a nominal 4000°K colour temperature	
<b>Code</b>	<b>Lens</b> (required)	
.PGL	Prismatic Glass Lens	
.CGL	Clear Glass Lens*	
<b>Code</b>	<b>Distribution</b> (optional)	
.NR	Long and narrow light distribution*	
.AY	Asymmetric light distribution**	
.SY	Symmetrical light distribution***	
<b>Code</b>	<b>Colour</b> (required)	
.C1	Smooth White (RAL 9016)	
.C4	Textured Graphite (RAL 7011)	
.C6	Smooth Grey (RAL 7035)	
.C7	Black (RAL 9005)	
.C9	Metallic Silver (RAL 9006)	
.RAL****	RAL Colour (customer choice)	
<b>Code</b>	<b>Paint Finish</b>	
.C	Enhanced Paint Finish	
<b>Code</b>	<b>Photocell</b>	
.T	Photocell fitted	
<b>Code</b>	<b>Emergency</b>	
.EM3	3hr maintained emergency	
<b>Code</b>	<b>HF Control Gear</b>	
.LRD	DALI Enabled	
<b>Example</b>	DEW .26PL4 .PGL .ULS .C7 .C .T .EM3 .LRD	

\*Available with .LA014/LA013 and .LA024/LA023 lamp options only. \*\* Not available with .LMXXX options \*\*\* Available with .LM014, .LM024 and .LM034 options only.

Lumen data is considered to be representative of the configuration shown, and may vary, with a tolerance on flux of +/- 7% (typical of LED manufacturers data) and luminaire power of +/- 5%.



### luminaire accessories

#### Code

**GL.M20** 1 x M20 IP68 plastic gland for cable entry suitable for cables between 6mm - 13mm Ø

Note: For specific LED variant data please contact Holophane for Denver™ Elite Wall LED data sheet



Other products in the  
Denver™ Elite family range

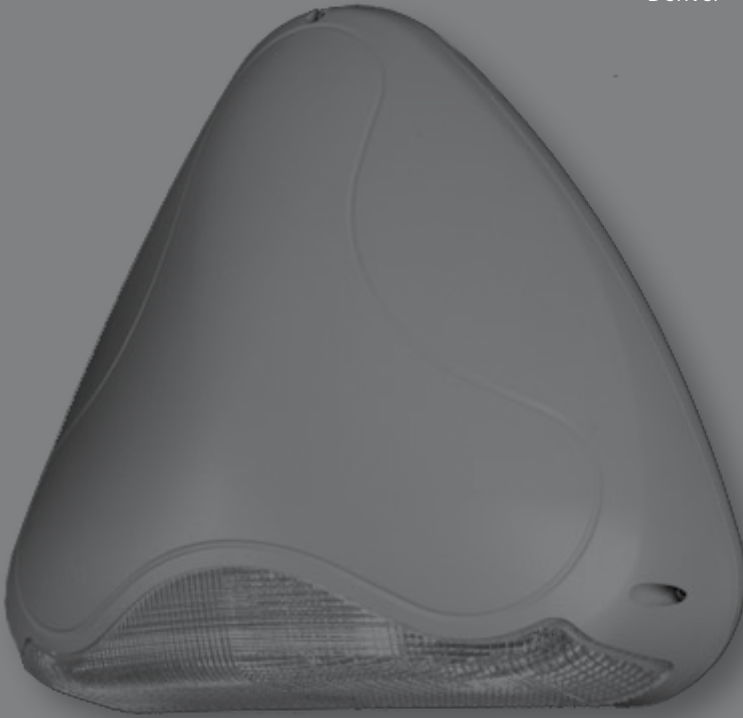

Denver™ Elite Pole



Denver™ Elite Bollard



Holophane Europe Limited  
Bond Avenue, Bletchley, Milton Keynes MK1 1JG United Kingdom  
Telephone: +44 (0) 1908 649292 UK Fax: +44 (0) 1908 367618  
International Fax: +44 (0) 1908 367618  
E-mail: info@holophane.co.uk

[www.holophane.co.uk](http://www.holophane.co.uk)



THE QUEEN'S AWARDS  
FOR ENTERPRISE:  
INNOVATION  
2017



# CIRCUS

CIRCUS è una famiglia di plafoniere ed applique che trova origine dal cerchio: la parte frontale è definita da cerchi concentrici di diversi materiali e finiture, tra cui il vetro prismatico. L'apparecchio prende vista all'accensione, quando CIRCUS diventa un forte punto di luce centrale in grado di creare un doppio alone luminoso sulla superficie da illuminare. Questo grazie a due finestre ritagliate nella base. È una serie molto flessibile e personalizzabile, tramite gli anelli decorativi di chiusura disponibili in diversi colori, per adattarsi ad ogni ambiente.

CIRCUS is a family of ceiling luminaires and wall lights that originate from the circle: the front portion is defined by concentric circles of different materials and finishes, such as aluminium and prismatic glass. The device takes life when switched on, when CIRCUS becomes a strong point of the central light able to create a double luminous halo on the surface to be illuminated. This is thanks to two windows cropped in the base. It is a series of very flexible and customizable products through the decorative closing rings available in different colours to suit every environment.





## INFORMAZIONI TECNICHE

Corpo e base realizzati in lega di alluminio pressofuso verniciato e resistente alla corrosione. Protezione con trattamento di anodizzazione, fondo con polveri epossidiche e verniciatura poliestere. Anello decorativo da ordinare separatamente.

## TECHNICAL INFORMATION

Body and fixing plate made of die-cast aluminium alloy, corrosion resistant. Protection with anodizing treatment, epoxy powder base coating and polyester painting. Decorative ring to be ordered separately.

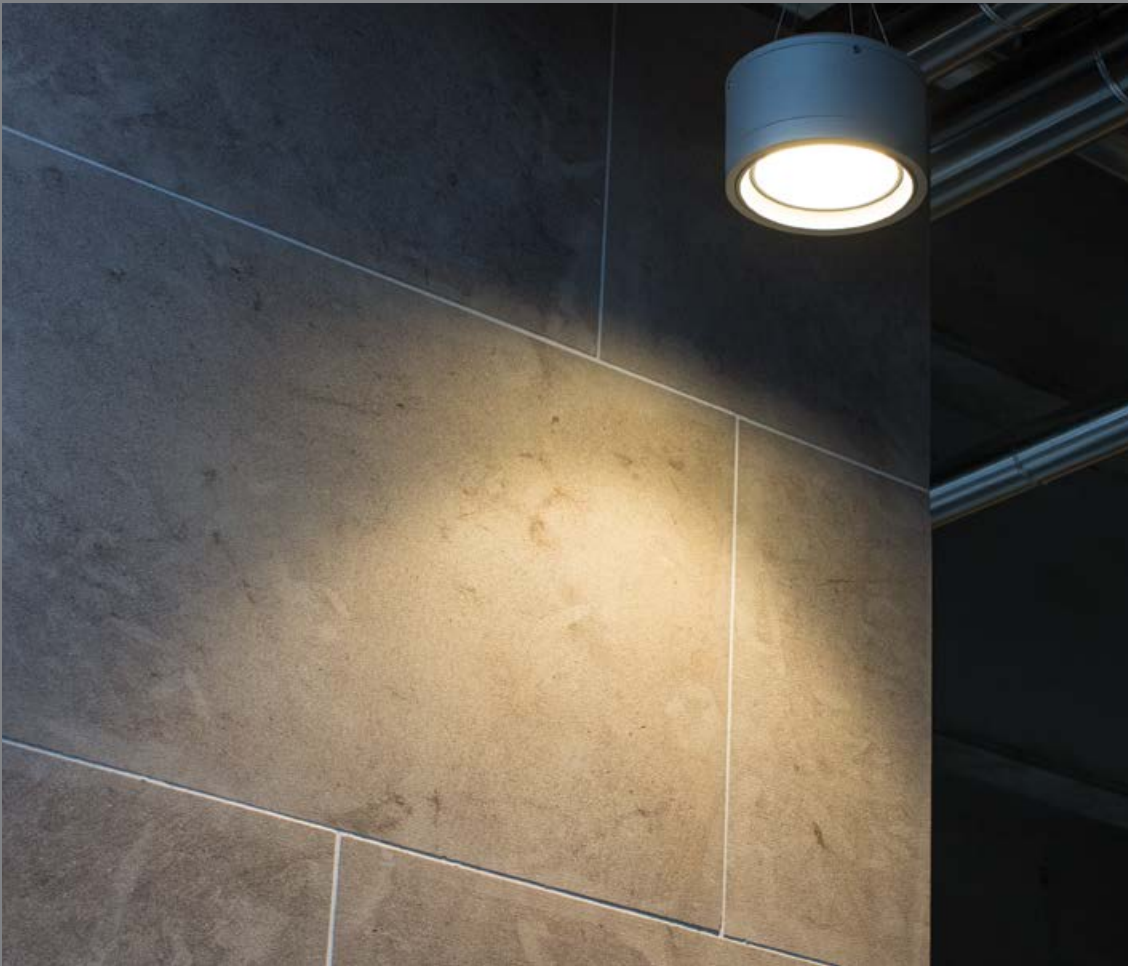

**WHITE  
COB LED  
230V**



DIFFUSE



**45 20 518**  
**LED 3000K COB CRI>80**  
 17W / 2610 lm LED data  
**18,3W / 1750 lm Real data**  
 220-240V 50/60Hz  
 A / A+ / A++

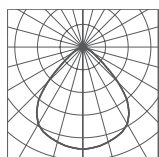

520  
cd/klm

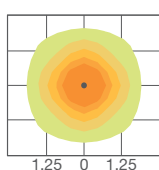

2,5 3000K  
H. 3m  
@500 mA  
1,25  
0  
1,25  
190 lux  
150 lux  
110 lux  
70 lux  
30 lux  
(m)

**PRODUCT INFORMATION**

IP65  
IK 08  
5 mm flat tempered  
sandblasted glass  
Cable input Ø 1±18 mm

**AVAILABLE COLOURS**

■ .02 white  
■ .06 grey  
Other colours on request

**TECHNICAL DATA**

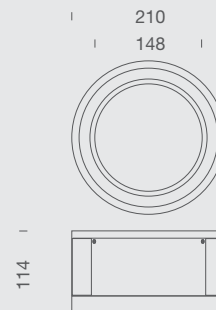

**Disponibile su richiesta senza maggiorazione di prezzo** (per la composizione del codice consultare pagina 8)  
**Available upon request without surcharge** (for the code composition, please refer to page 9)

**HELP YOU**

**LED**  
LED COLOURS  
TEMPERATURE  
4000K

Other LED colours  
available on request

**COLORS**  
**FINISHES**  
■ .01 black  
■ .07 corten  
■ .08 anthracite  
■ .09 bronze

**INFO**  
Ulteriori versioni sono  
disponibili consultando  
[www.platek.eu](http://www.platek.eu)

More versions are available on  
[www.platek.eu](http://www.platek.eu)

**ACCESSORI** (per maggiori dettagli consultare pagina 321)  
**ACCESSORIES** (for further details please refer to page 321)



**DECORATIVE RING**  
page 345  
89 54 001.01 - black



**DECORATIVE RING**  
page 345  
89 54 001.06 - grey



**DECORATIVE RING**  
page 345  
89 54 001.02 - white

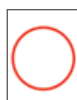

**DECORATIVE RING**  
page 345  
89 54 001.70 - red



**DECORATIVE RING**  
page 345  
89 54 001.04 - steel



More details at:  
[platek.eu/  
CIRCUS](http://platek.eu/CIRCUS)

