

1 PARAPET DETAIL

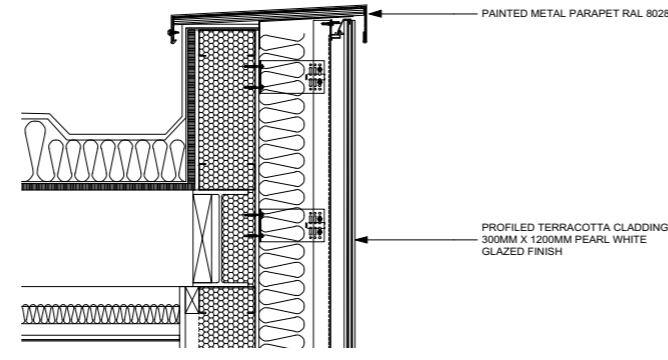

7 PARAPET DETAIL AT TERRECOTTA CLADDING

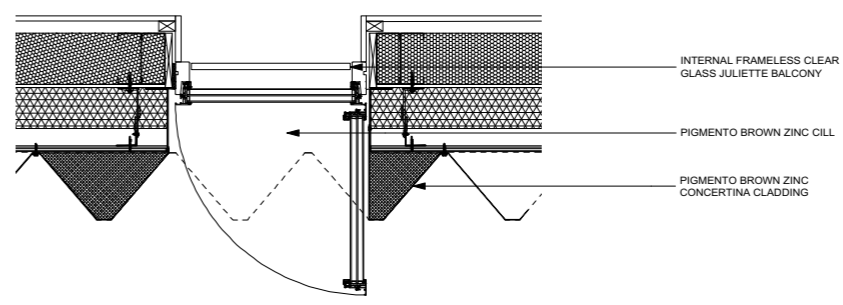

12 PLAN SECTION OF WINDOW SOUTHERN ELEVATION

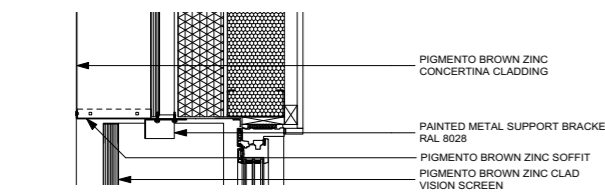

2 WINDOW HEAD DETAIL

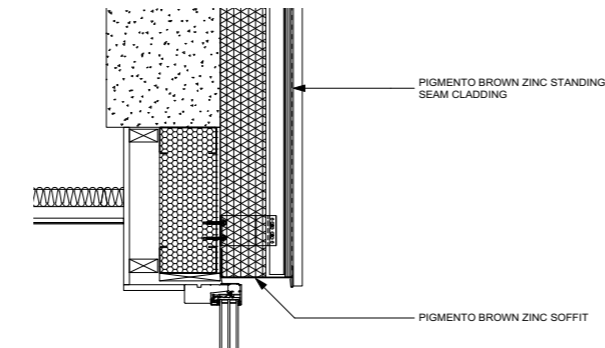

8 WINDOW HEAD DETAIL STANDING SEAM

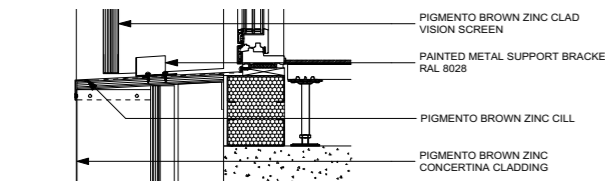

3 WINDOW CILL DETAIL

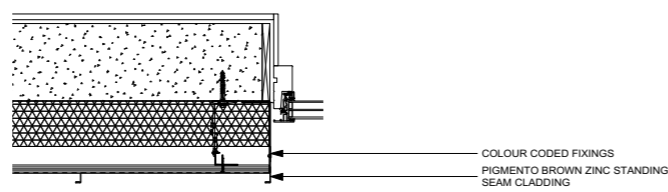

9 WINDOW JAMB DETAIL STANDING SEAM

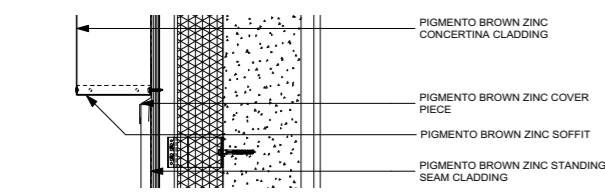

4 JUCTION DETAIL CONCERTINA CLADDING AND STANDING SEAM

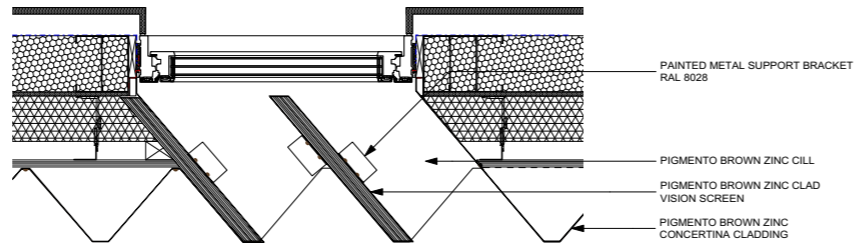

10 PLAN SECTION OF WINDOW LOUVRE

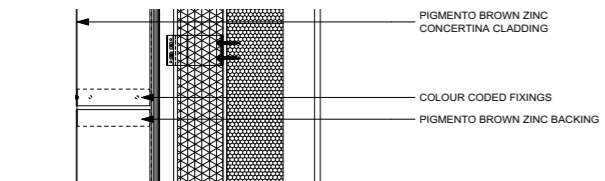

5 BUTT JOINT DETAIL

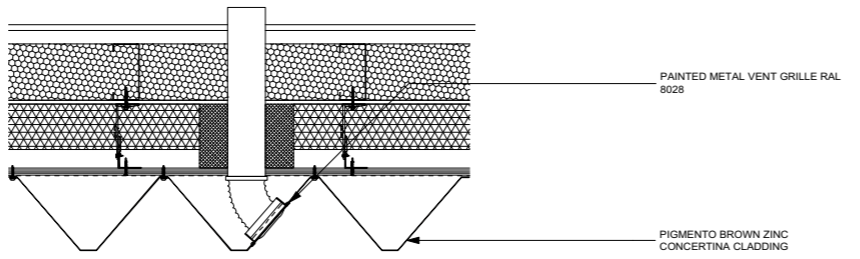

11 VENTILATION GRILLE DETAIL

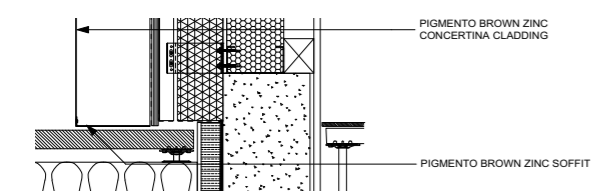

6 BASE DETAIL

REV.	DATE	DESCRIPTION

THE OLD DAIRY  
WAKEFIELD STREET

PLANNING CONDITION NO.3  
CLADDING DETAILS

DRNG No 1250-20-008	SCALE 1:10 @ A1	DATE MAY - 18
------------------------	--------------------	------------------



5 ST JAMES'S SQUARE  
LONDON SW1Y 4JU  
T 020 7451 0955 mail@stanhopegate.co.uk  
www.stanhopegatearchitecture.com

