

# Free Standing Smart City Communication Hub

JCDecaux



Rendered Image

# Free Standing Smart City Communication Hub

## Colour

- Metal Chain Grey
- JCD 7002

An integrated touch screen designed for public phone use, and a range of other android compatible functions to enable users to access the internet and Council webpages



# Free Standing Smart City Communication Hub

JCDecaux



Beacons



Wifi and Small cell



Speaker



Voice recognition \*

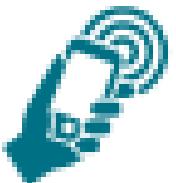

Static/Dynamic NFC

## Functions and Sensory Parameters

\* Currently under development

# Free Standing Smart City Communication Hub

JCDecaux

## Overview

A payphone kiosk and interactive communication apparatus contained within a 32" display screen.

Designed and developed by JCDecaux

## Characteristics

Structural outer casing fixed to 2 structural legs clad with metal skirts.

- Touch Screen - An integrated space with metal housing set within the face of the unit.

## Display Details

32" touch screen features a Full HD resolution at 1920x1080 pixels.

The technology used to display the images. Screen is designed to be visible outdoor in direct sunlight. The unit also features an auto-dim function so adjust the luminance of the display to ambient levels.

## Visible area

LCD 16/9 Portrait screens

32": 0,27m<sup>2</sup> (392mm x 698mm)

## Telecom equipment and Touch screen

Public phone.

Customized Council home page - an Android based application with an interactive screen for dialling numbers.

Secure Android applications featuring location-based services.

A touch pad is available under the screen to users with mobility impairment.

## Accessibility

Furniture easily acknowledged by blind and partially sighted pedestrians.

Height of phone equipment from ground level enables access by wheel chair users.

No sharp edges or profiles are present in the structures design.

## Pad touch 5.7"

Touch screen in compliance with accessibility standards thanks to the pad below the screen at 900mm from ground

## Solar panel

Solar panel on canopy roof.

## Foundation and groundwork

Furniture installed on to a concrete base with concealed fixing points.

Separate underground ducting for power, data and earth protection via an earth mat.

All calculated in relation to local requirements

## Standards and certification

CE certified and RoHS compliant.

R&D and manufacturing to ISO 9001 and ISO 14001 standards.

## Reliability

Internal temperature maintenance control for both hot and cold seasons : ventilation is achieved via a filtered air cooling system that manages the internal temperature of the ad case and increases the life expectancy of components.

- Waterproof (power-hose from any angle)
- Dust resistant
- Rust resistant
- Sun fading resistance

Life expectancy is 5 years with normal usage (24/7) for the interactive touchscreen.

# Free Standing Smart City Communication Hub

JCDecaux

## Environmental Considerations

Automatic adjustment of the light intensity according to the location and the ambient light to rationalize as far as possible the energy required to operate the screen

Use of a powder coating without any Volatile Organic Compounds (VOC)

Electrical and electronic equipment recycled according to WEEE regulations

Unit mainly manufactured from sustainable and recyclable materials

## Brightness

Maximum night time maximum brightness is 600Cd/m<sup>2</sup> (600 nits) as per ILP recommendations. Excellent visibility in all conditions, even under direct sunlight.

Brightness levels to respond and adjust to ambient lighting :

- No glare risk
- Minimizing power consumption

## Digital Management Software

### *Web Interface*

Management of the display from a specific software platform available on any computer connected to the internet with access rights

Panels are collectively or individually programmable in advance

Intuitive, efficient and easy to use programming interface developed by JCDecaux

Automatic update with no need for human intervention on the computer workstations

### *Contents Scheduling*

Creation of messages and message loops

Setting of the duration and order of messages

Instant transmission between messages being entered and being received by the panel

Consultation in real time of broadcast messages

Possibility of broadcasting a loop to all the panels, to a group of panels or to individual panels

### *Contents Storage*

Periodic local update and storage of the contents (128Gb capacity) to feed the display loop avoiding any

rupture of the broadcast in case of connection failure

Display of a neutral message in case of dysfunction

## Electrical

Power supply

220 V / 240 V - 50 Hz

Connection to the mains grid

Electric plate located in the foot

Protection

20A RCCB - 30 mA differential circuit breaker

# Free Standing Smart City Communication Hub

## Materials

Material	Treatment against corrosion	Defined	Main parts
Steel	Hot dipped galvanizing Centrifugal galvanizing		Foot structure Anchoring rods
Stainless Steel	Passivation		Screwing
Aluminum	Chromate conversion*	80µm powder paint	Casing – Door - Skirts
Tempered glass 6mm		Silk Screen Printing	32" screen glass
Concrete			Foundation

*\*Environmentally friendly treatment free from hexavalent chromium*

## Resistance to Vandalism

- Skirts with smooth surfaces for easy cleaning and removal of any illegal stickers
- Protection rating against impacts > IK10 (corresponding to a 2-kg mass dropped from a height of one metre)
- Exterior Payphone Façade surround made of a patterned stainless steel non-scratch material
- Electrical circuitry inaccessible to the public
- Secured casing opening for access to the PC and other equipment by a double locking system.
- No exposed screws
- Unit made from non-flammable materials
- All painted metal surfaces are coated with a high performance paint that is highly resistant to graffiti cleaning products
- Data transfers are protected by Firewall and password

## Remote monitoring

Unit fitted with sensors to check its operating status at all times. Errors are sent automatically over the network to the monitoring centre in the event of a malfunction

## Data Transmission

- Set of secure connections:
- from the transmitter to the data server by means of a broadband link
  - from the data server to the different communication devices by an ADSL or fiber link with a 3G/4G/5G backup

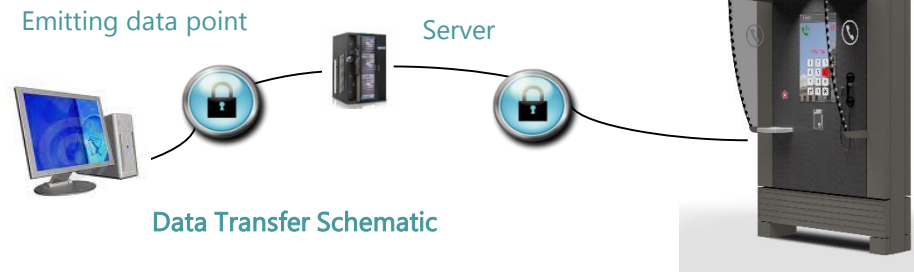

Data Transfer Schematic

# Free Standing Smart City Communication Hub

JCDecaux

Unit Front

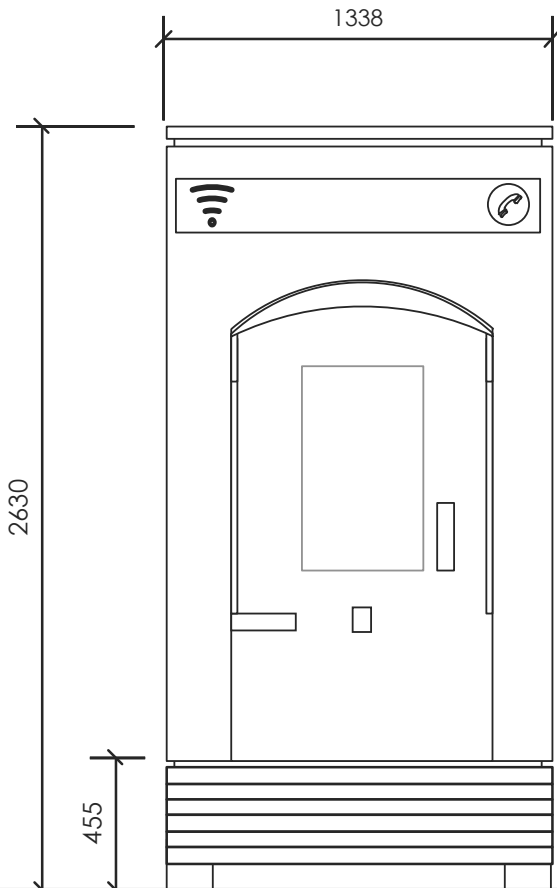

Unit Side

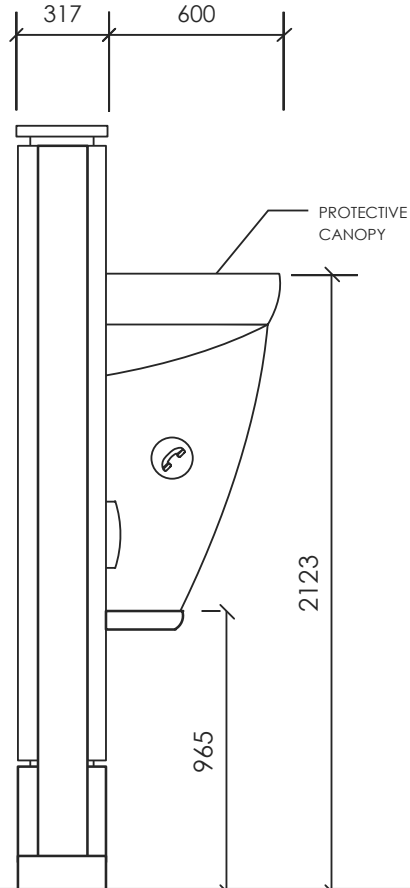

Unit Rear

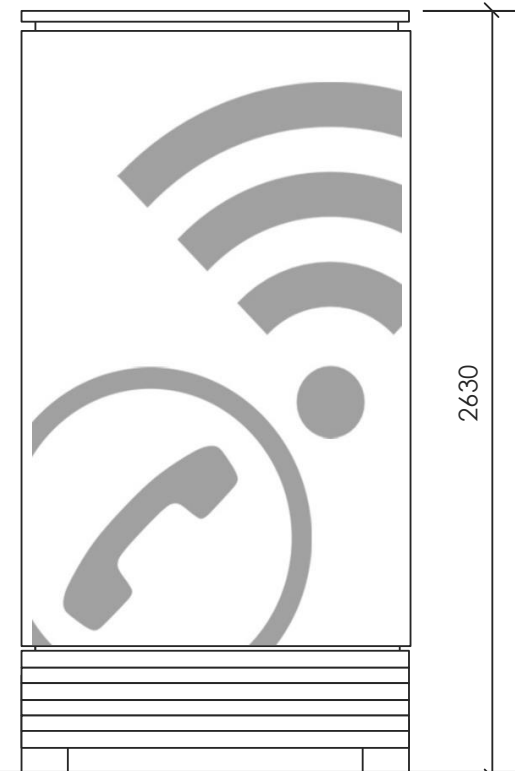

Elevation Drawings Scale 1:25 @ A4

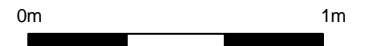

# Free Standing Smart City Communication Hub

JCDecaux



## Operating conditions

Temperature: -15 to 45°C  
Humidity: 10% / 90%



## Digital Interactive Screen

Technology : LCD  
Touch technology of the 32" Capacitive  
Aspect ratio 16:9  
Orientation Portrait

## 32" specifications

Resolution Full HD (1920x1080 pixels)  
Light technology Edge LED  
Brightness Max 2500\* Cd/m<sup>2</sup> (2500nits)

Night time limit level 600Cd/m<sup>2</sup> (600nits) as per ILP recommendations.

Automatically adjustable according to ambient light.



## Dimensions

Visible area:  
• 32": 0.27m<sup>2</sup> (392mm x 698mm)

Global:

• 1338mm (W) 2600mm (H) 312mm (D) (600mm canopy)



## Electricity

Input Voltage: AC 240 V 50/60hz  
Max Power: 2260 W  
Average consumption : 24,5 kWh/day (based on 24h/24 working hours)



## Connections

PC included  
Data: ADSL/4G/5G  
A secure solution to ensure full control of the content broadcast



## Certifications : CE



## Comments :

Selected best in class screens in term of visibility in full sunshine.  
It includes state-of-the-art features to lower TCO :

- Improved reliability and life through expert thermal and solar management design.
- Modular design.
- Extensive monitoring capability through Digital Image verification that gives immediate feedback about display performance.

Premium product for reliability, monitoring and maintenance features



# Existing Kiosk Elevation Montage

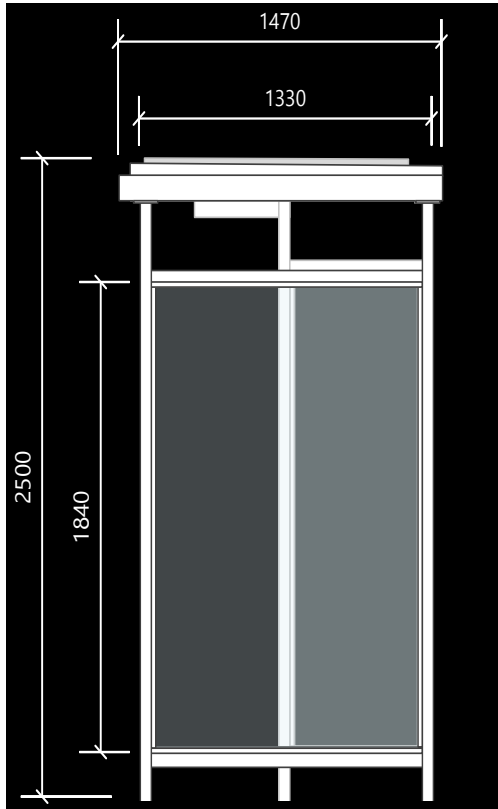

Left Side of the Kiosk

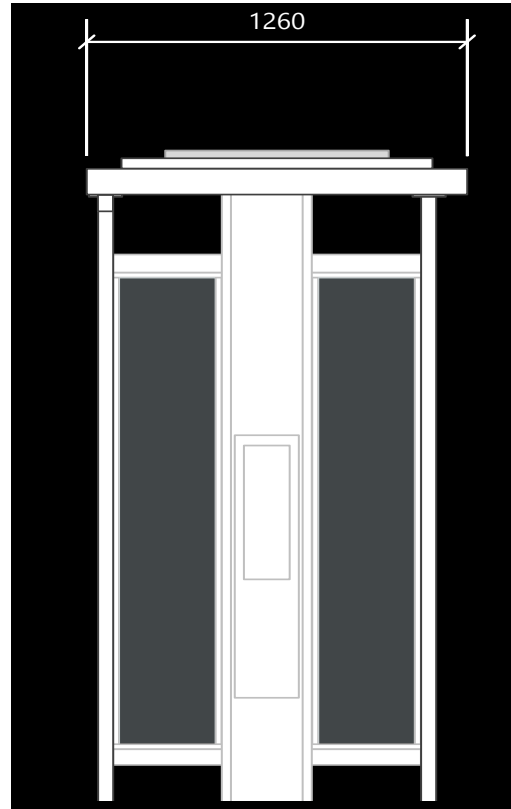

Internal View Showing Telecom Apparatus

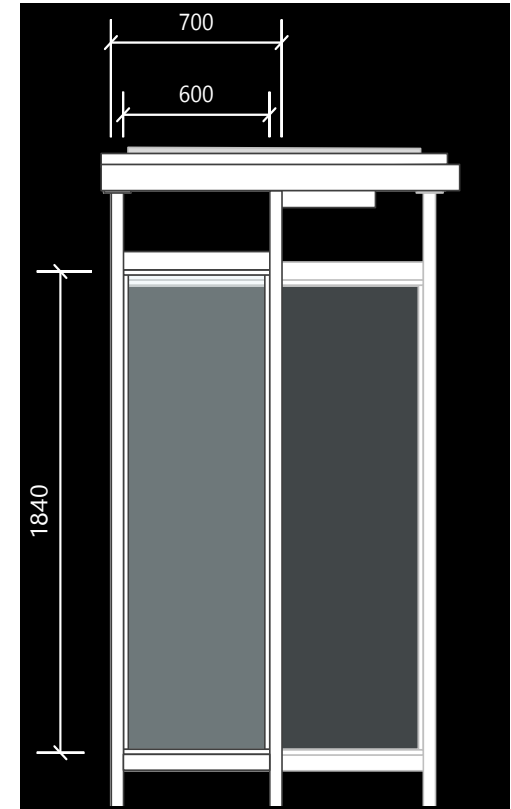

Right Side of the Kiosk

Drawing Number 01/2521  
Scale: NTS  
Description: Current Mark I Payphone Kiosk

# Existing Kiosk Elevation Montage

JCDecaux



Drawing Number

01/2523

Scale:

NTS

Description:

Infocus mark I three sided Kiosk

# Existing Kiosk Roof Plan

JCDecaux

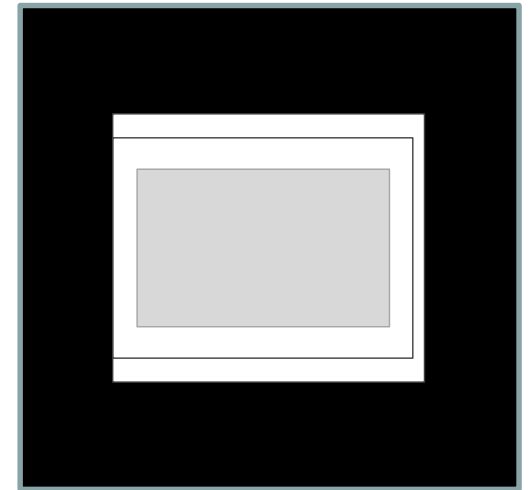
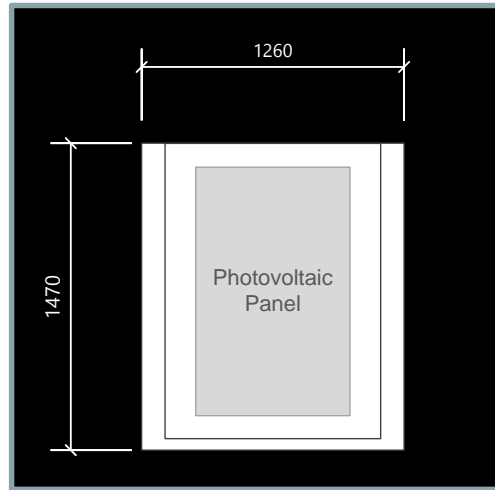
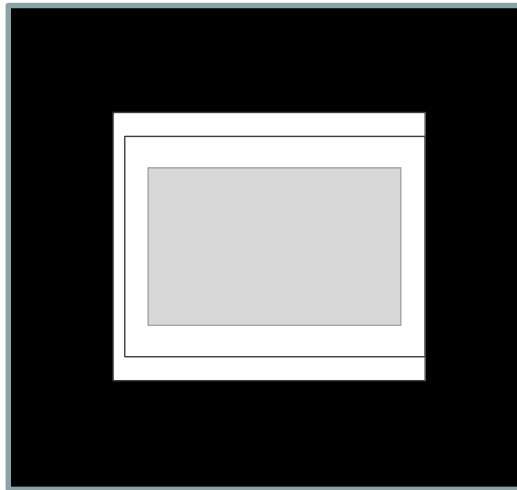

Drawing Number 01/2522  
Scale: NTS  
Description: PV Roof Plan

# Replacement Kiosk Comparison Image

JCDecaux

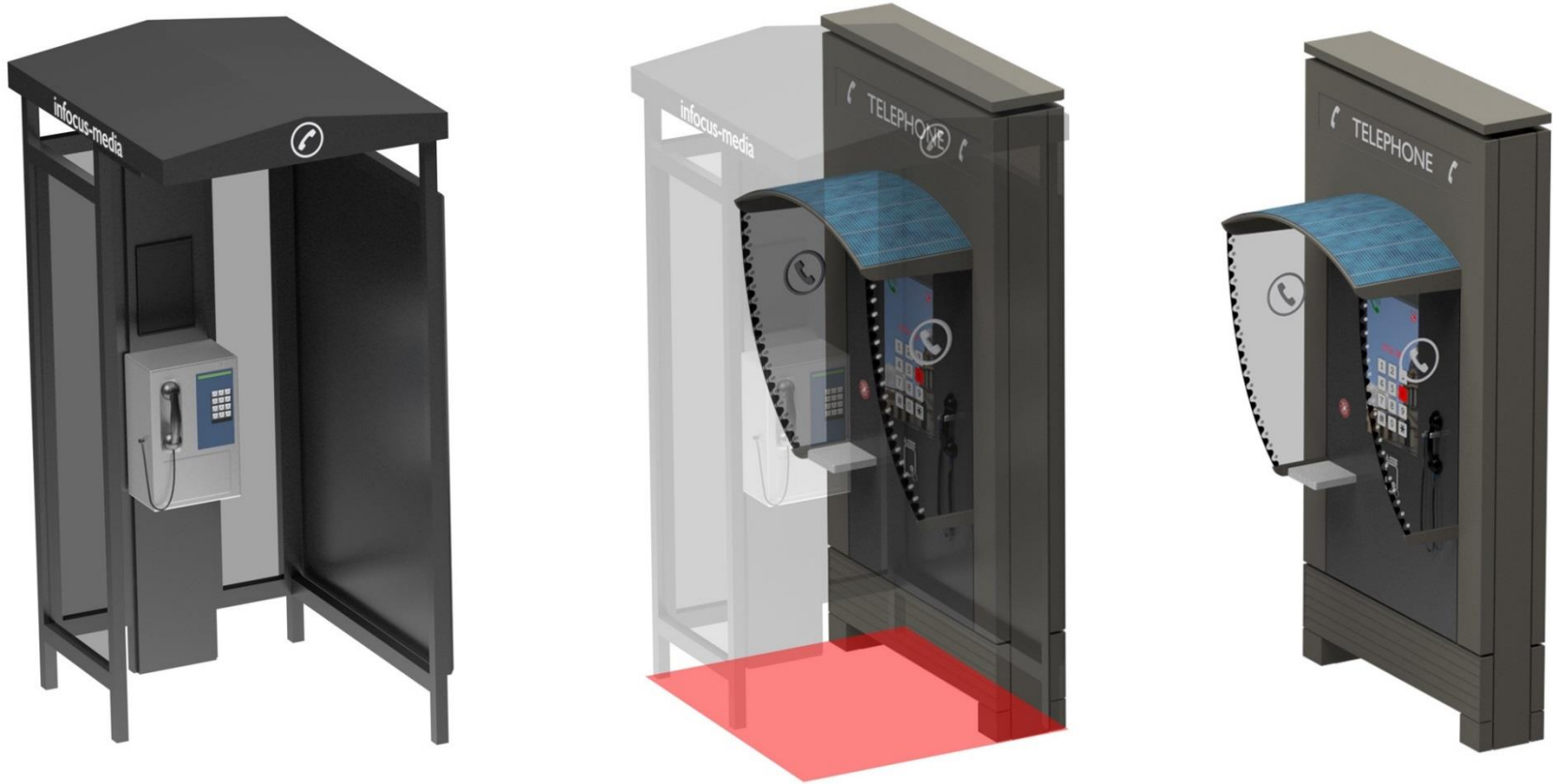

Drawing Number

01/2525

Scale:

NA

Description:

Images Showing Scale of Existing and Proposed Kiosk Units

# Free Standing Smart City Communication Hub

JCDecaux

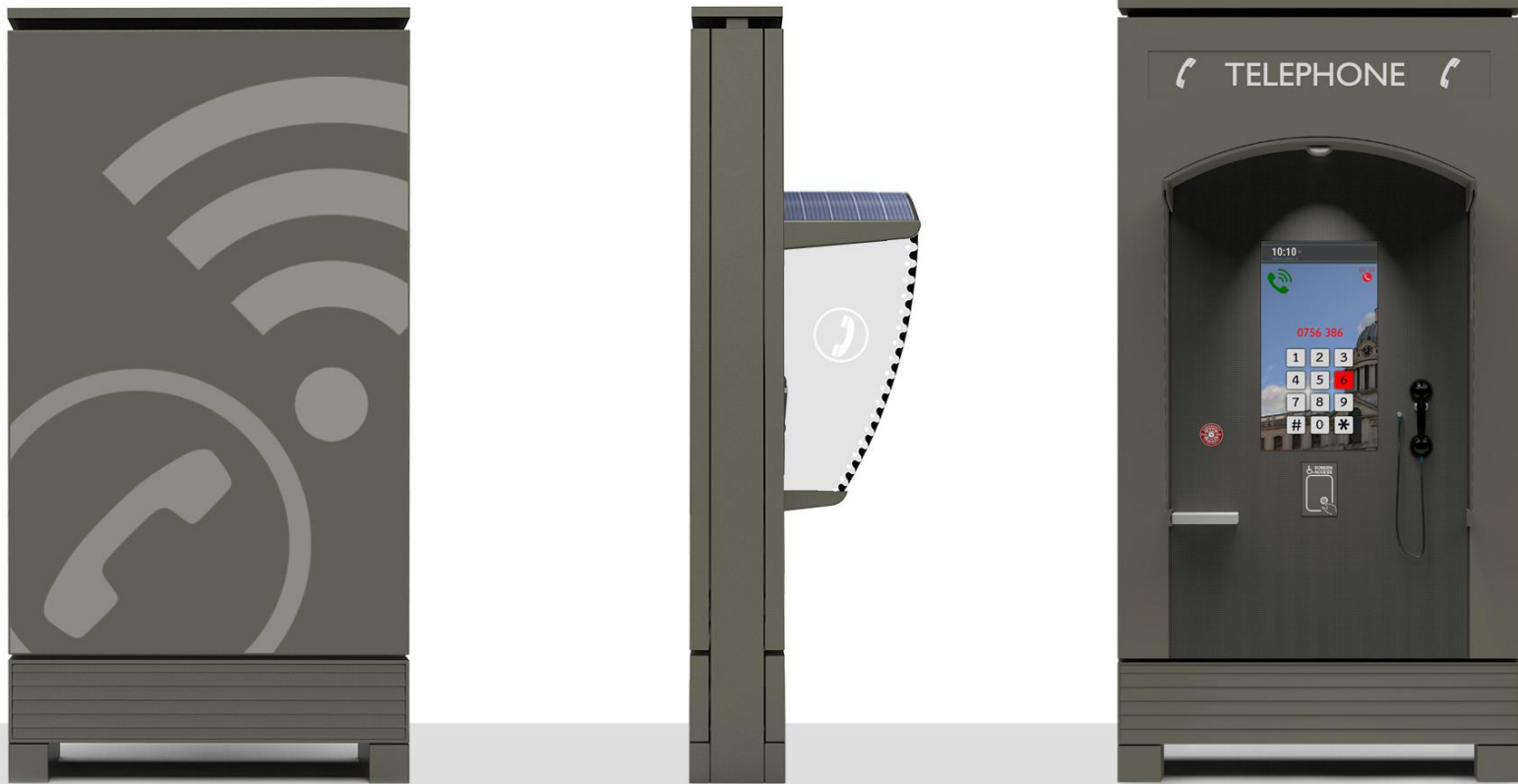

Photomontage – Replacement Communication Hub

# Free Standing Smart City Communication Hub

JCDecaux



Photomontage