

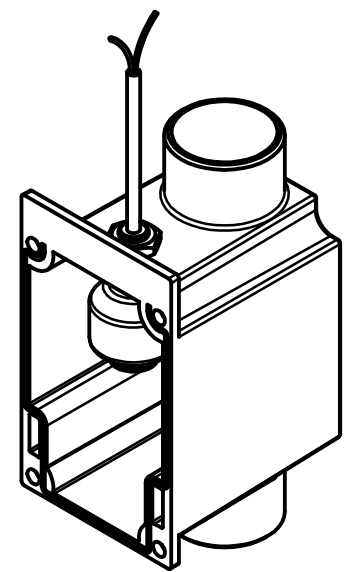

1x

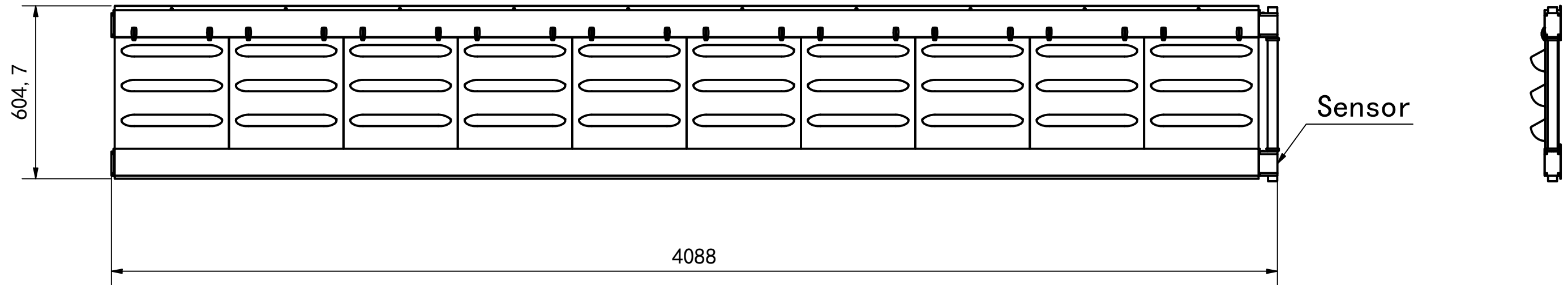

Sensor: 1x

$$4,088 \times 0,6047 = 2,47 \text{ m}^2$$

	DATE	19-2-2019	DRAWING NO.	
	DRAWN	qdp/QDP	19-2287-01-01	
	UNITS	mm		
			REV	A
			B	D
		PROJECT NAME		Format
		Rokit, London (1)		A3
SIGN FOR APPROVAL	SIGN DATE			

6

5

4

3

2

1

1x

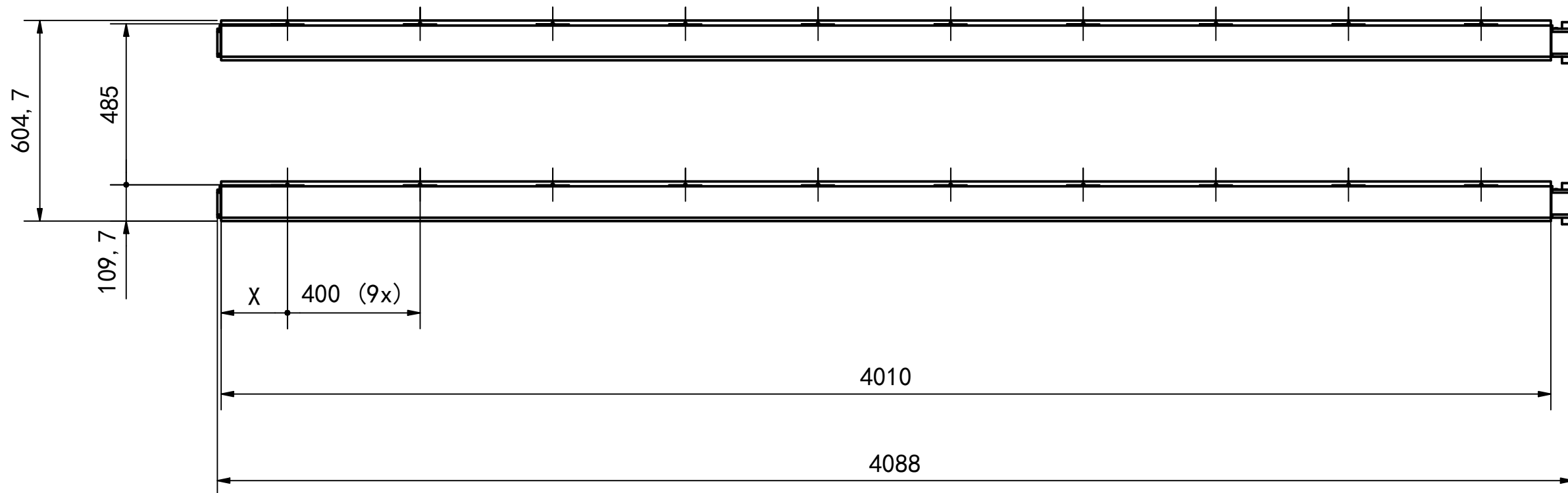

$4,088 \times 0,6047 = 2,47 \text{ m}^2$

	DATE	19-2-2019	DRAWING NO.		
	DRAWN	qdp/QDP	19-2287-01-01		
	UNITS	mm			
		REV	A	C	
			B	D	
		PROJECT NAME			Format
		Rokit, London (1)			A3
SIGN FOR APPROVAL	SIGN DATE				

All rights are reserved. Reproduction in whole or in part is prohibited without the written consent of the copyright owner. 版权所有，未经许可不得制造生产图纸。

1x

Part List

Part Name	QTY	Description
14-0122-00-01_L4010	2	Profile (L=4010)
14-0122-00-09	20	Cassette clip
14-0122-00-12	2	Endcap 2K
14-0122-00-13	2	Hose connection 2K
14-0122-99-00	1	Spare part kit
14-0122-99-01_3	1	Tube
14-0122-99-02	2	Hose clamp
14-0122-99-04	2	Plug
14-0122-99-05	16	DIN-7981/A2 3,9x19 T15 + Gleitmo 625
14-0122-99-06	20	fischer UX 8x50
14-0122-99-07	20	fischer 5.0 x 60 CK RVS A2
18-1678-01-00_3SL	10	Cassette (slots)
14-0122-99-03	1	Sensor

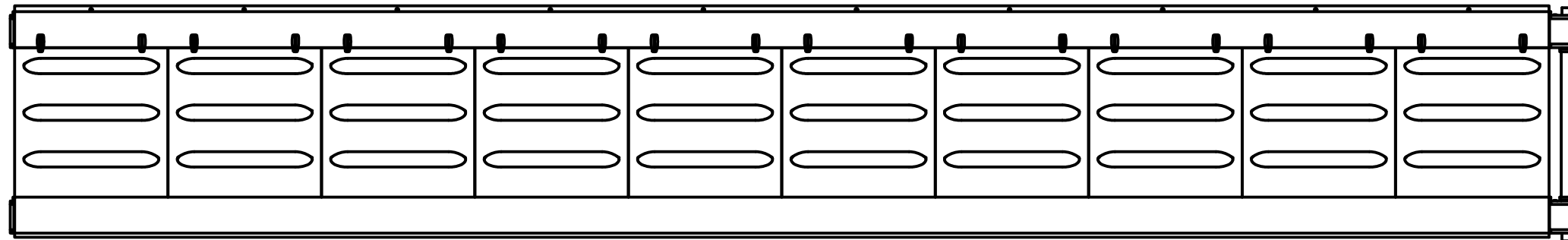

2,47 m2

	DATE	19-2-2019	DRAWING NO.	
	DRAWN	qdp/QDP	19-2287-01-01	
	UNITS	mm		
SIGN FOR APPROVAL	SIGN DATE	REV	A	C
			B	D
PROJECT NAME			Format	
Rokit, London (1)			A3	

All rights are reserved. Reproduction in whole or in part is prohibited without the written consent of the copyright owner. 版权所有，未经许可不得制造生产图纸。