

Type 02  
Painted Plywood faced door  
Plant room for MVHR unit

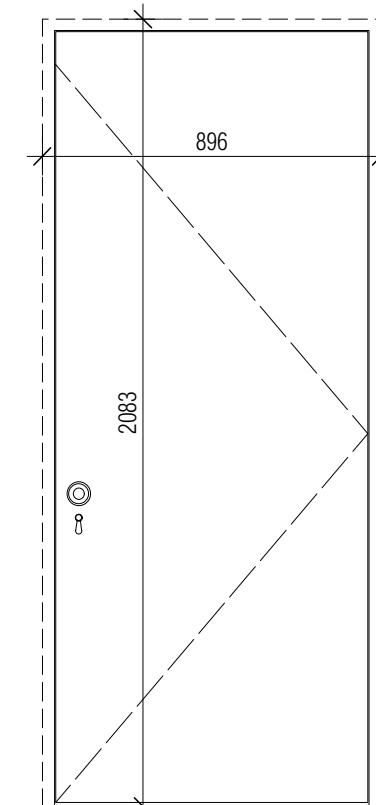

Type 03  
Painted Plywood  
faced door

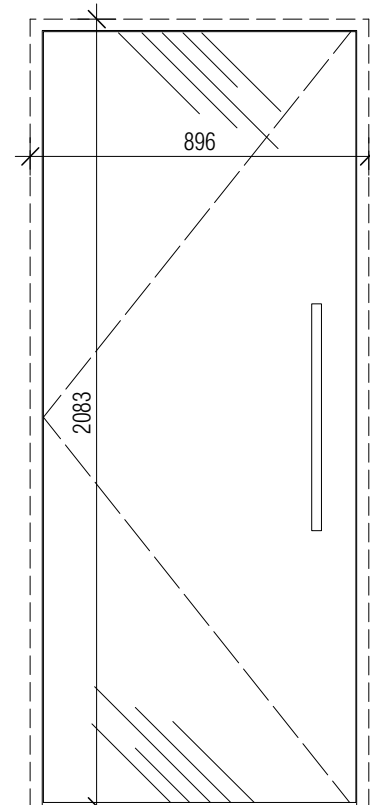

Type 04  
Glass door  
Shower rooms

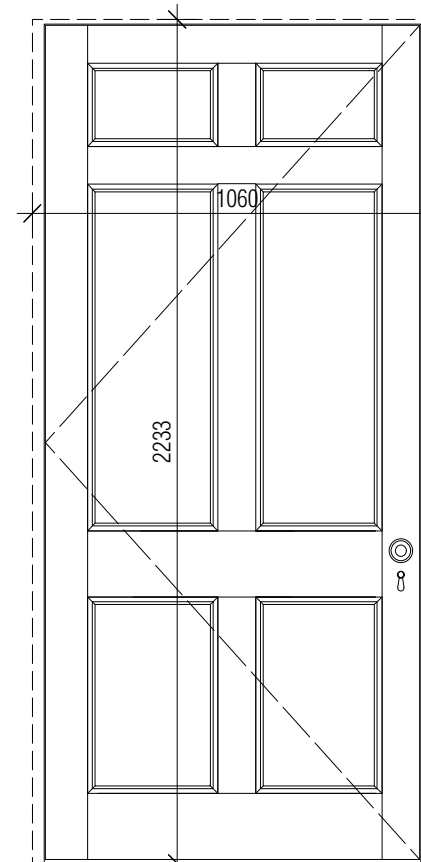

Type 05  
Primary 6 Panel  
Pine Faced/Painted door  
Library \*

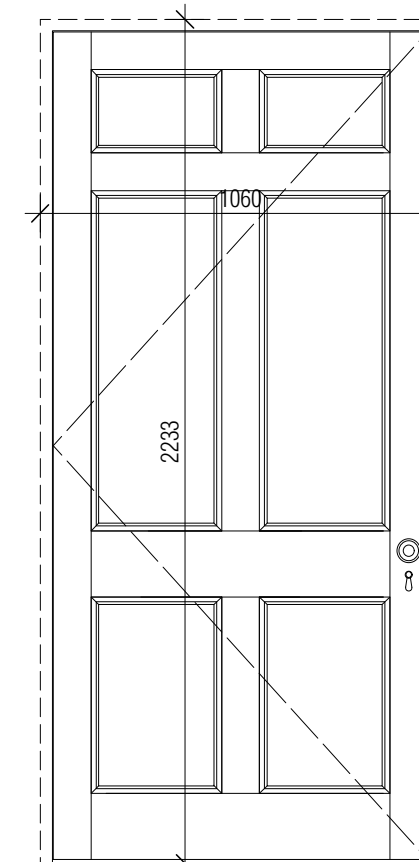

Type 06  
Primary 6 Panel  
painted door  
(Panel mould 1)

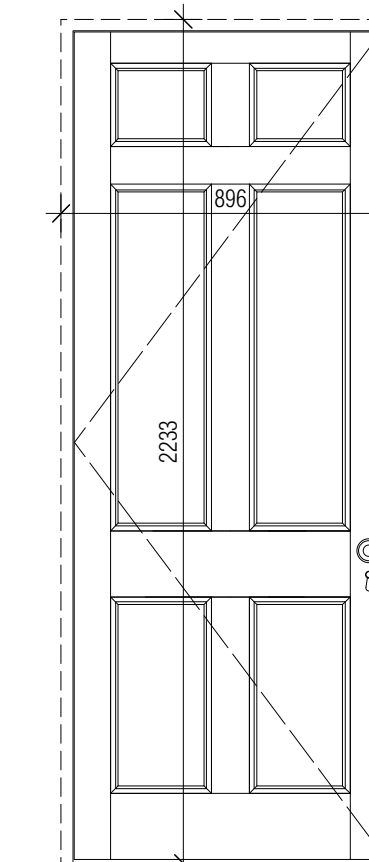

Type 07  
6 Panel painted door  
(Panel mould 1)

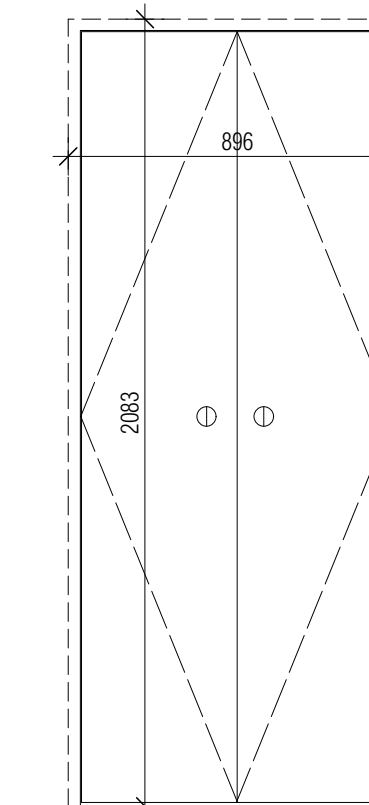

Type 08  
Lobby cup'd door  
Panelled jib door  
tbc

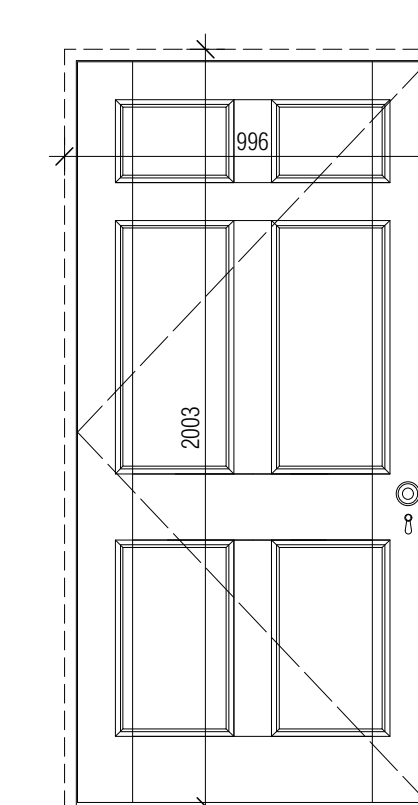

Type 09  
4 Panel painted door  
(Panel mould 1)  
Master Bedroom

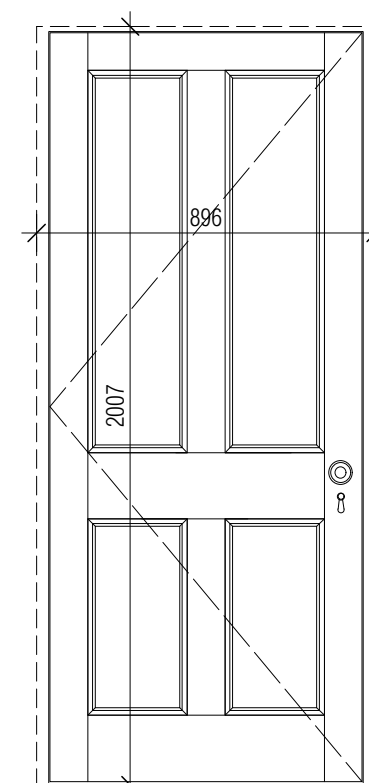

Type 10  
4 Panel Painted Door  
(Panel mould 2)  
Lower Ground Floor

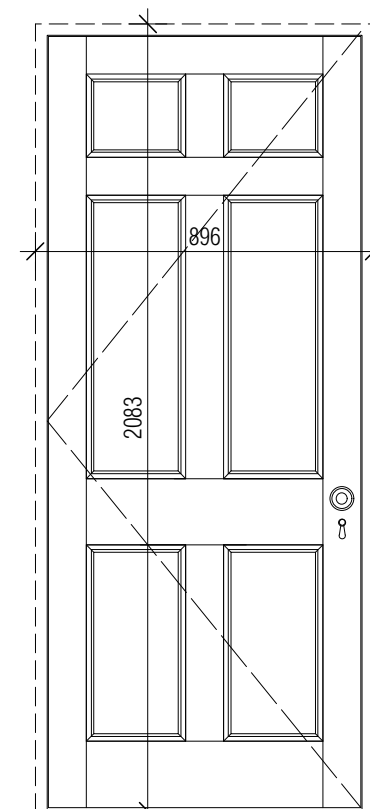

Type 11  
6 Panel Painted Door  
(Panel mould 2)

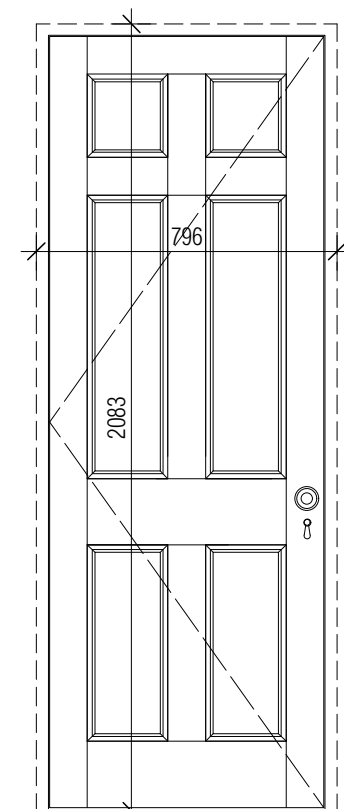

Type 12  
6 Panel Painted Door  
(Panel mould 2)

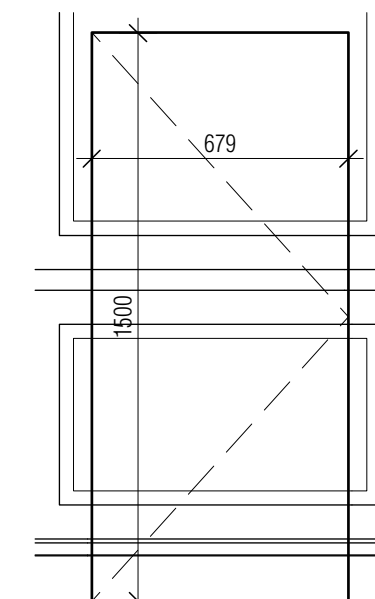

Type 13  
Cub'd jib door to match  
panel/mouldings  
Rear vestibule

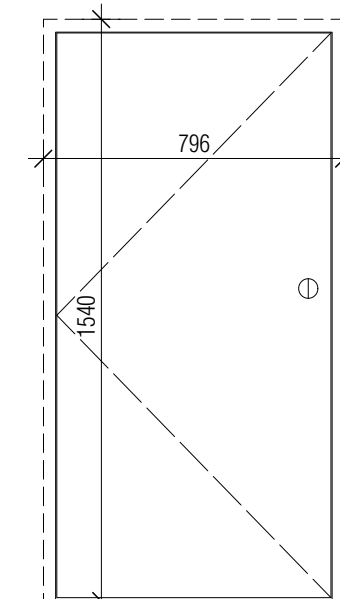

Type 14  
Cub'd jib door  
Understairs cub'd

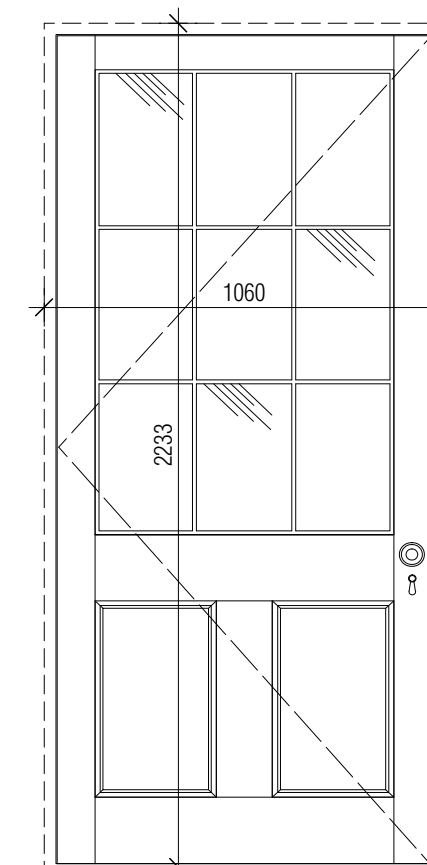

Type 15  
Part Glazed door  
(Panel mould 1)  
Panel Door

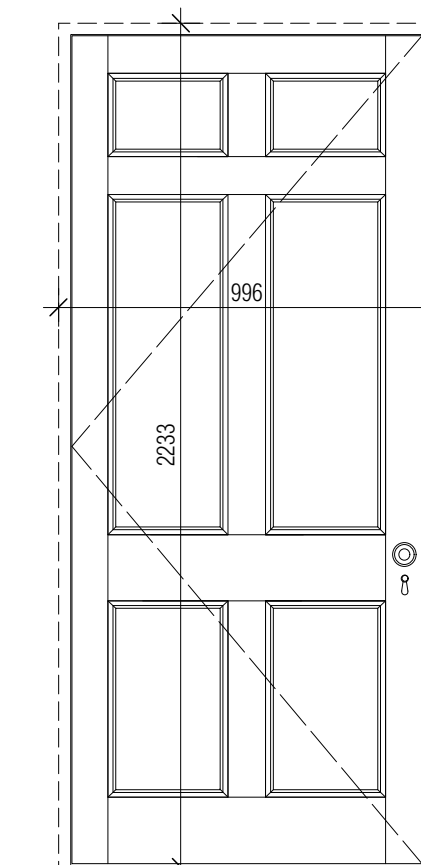

Type 16  
Primary 6 Panel  
(Panel mould 1)  
Painted door

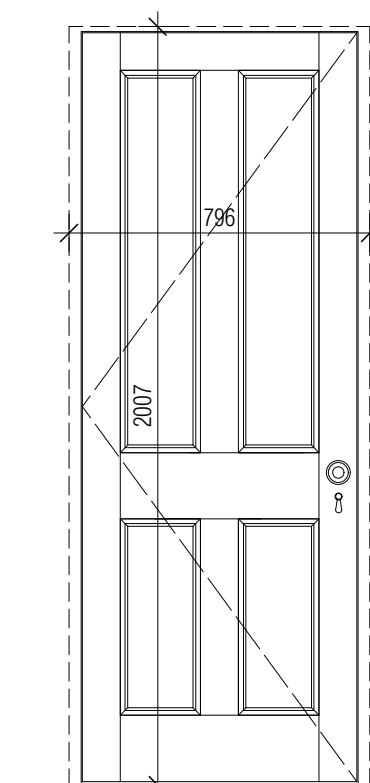

Type 17  
4 Panel Painted Door  
(Panel mould 2)  
Lower Ground Floor

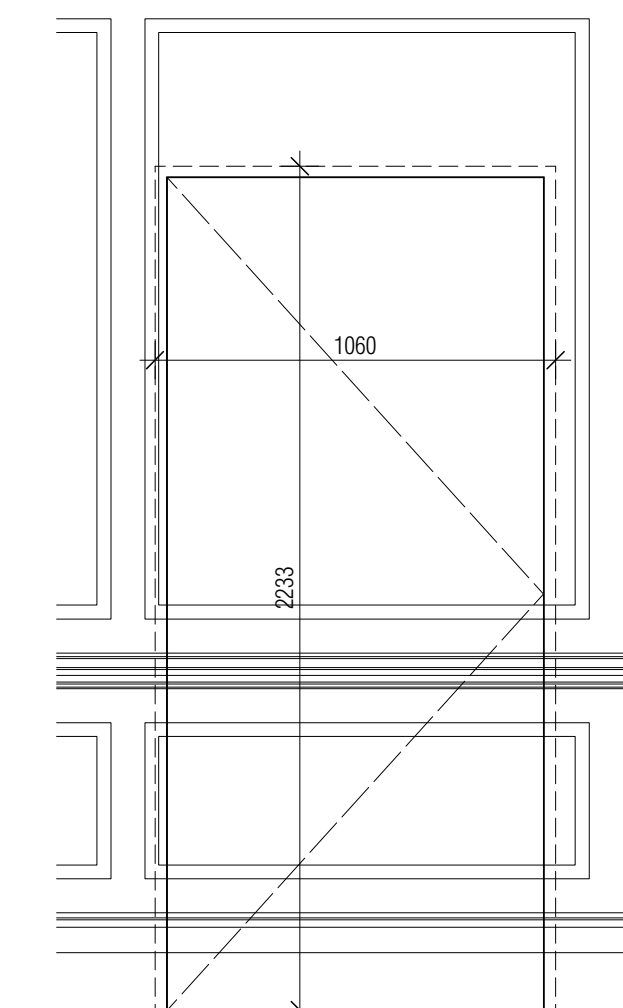

Type 18  
Jib Door to Dining Hall  
DG13-1  
- Type 6 facing the other side

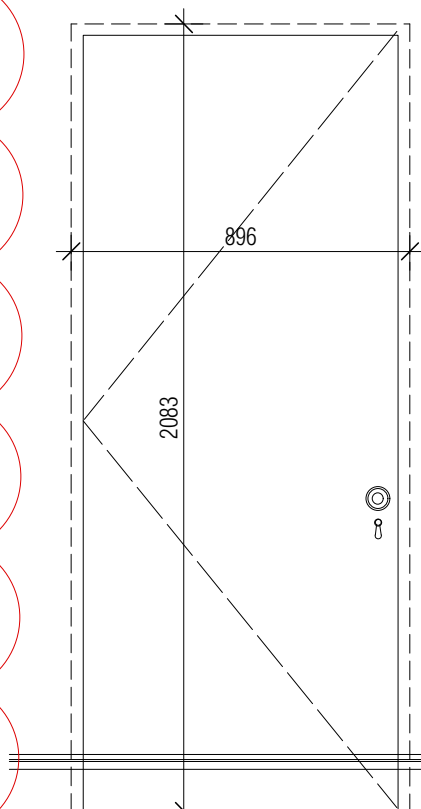

Type 19  
Jib Door to Rear Landing  
DF15-1  
- Type 11 facing the other side

PANEL MOULDINGS

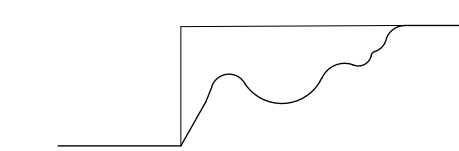

APPROVED panel moulding 1  
taken from Drawing Room entrance reveal - raised and fielded???  
see photo 043 20130507 taken in lower ground floor for profile

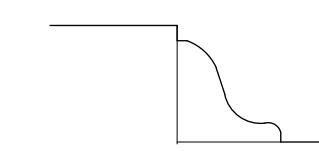

APPROVED panel moulding 2  
taken from Dining Room entrance reveal - raised and fielded???  
see photo 045/038 taken in lower ground floor for profile

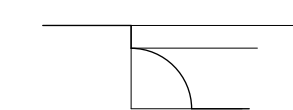

Panel moulding 3

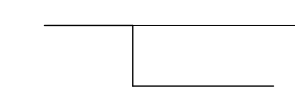

Panel moulding 4

ALL DIMENSIONS TO BE CHECKED ON SITE. BRACKETED DIMENSIONS ARE FOR CHECKING AND NOT FOR SETTING OUT PURPOSES. ANY DISCREPANCIES ARE TO BE REPORTED TO THE ARCHITECT BEFORE COMMENCEMENT.

Notes  
\* Library door and door linings to be pine, with clear finish in the library and painted finish in entrance hall.  
**IMPORTANT: DIMENSIONS SHOWN ARE FRAME SIZE SEE INTERNAL DOOR SCHEDULE  
HH-1002 FOR DOOR SIZES, STRUCTURAL OPENING DIMENSIONS & SPEC**

Revisions		Project
T1	24.04.18	HEATH HOUSE, HAMPSTEAD, NW3 7ET INTERNAL DOOR TYPES
T2	29.08.18	
T3	21.11.2018	

**TENDER**

Project		Scale		Date
HEATH HOUSE, HAMPSTEAD, NW3 7ET		1:20 @ A1		29.01.2018
Drawing No. HH-840 T3				

CLIVE CHAPMAN  
ARCHITECTS  
SUSTAINABILITY CONSULTANTS  
4 EEL PIE ISLAND  
TWICKENHAM MIDDIX  
TEL: 0181 891 4837  
EMAIL: INFO@CCAR.CO.UK  
WEBSITE: WWW.CCAR.CO.UK