

Air Conditioning
Technical Data

RXYSQ-T8V



- > RXYSQ4T8VB
- > RXYSQ5T8VB
- > RXYSQ6T8VB

TABLE OF CONTENTS

RXYSQ-T8V

1	Features	2
2	Specifications	3
	Technical Specifications	3
	Electrical Specifications	4
3	Options	6
4	Combination table	7
5	Capacity tables	8
	Capacity Table Legend	8
	Integrated Heating Capacity Correction Factor	9
	Capacity Correction Factor	10
6	Dimensional drawings	12
7	Centre of gravity	13
8	Piping diagrams	14
9	Wiring diagrams	15
	Wiring Diagrams - Single Phase	15
10	External connection diagrams	17
11	Sound data	18
	Sound Level Data	18
	Sound Pressure Spectrum	20
12	Installation	22
	Installation Method	22
	Refrigerant Pipe Selection	24
13	Operation range	26

1 Features

Space saving solution without compromising on efficiency

- Space saving trunk design for flexible installation
- Covers all thermal needs of a building via a single point of contact: accurate temperature control, ventilation, air handling units and Biddle air curtains
- Wide range of indoor units: either connect VRV or stylish indoor units such as Daikin Emura, Nexura ...
- Incorporates VRV IV standards & technologies: Variable Refrigerant Temperature and full inverter compressors
- Customize your VRV for best seasonal efficiency & comfort with the weather dependant Variable Refrigerant Temperature function. Increased seasonal efficiency with up to 28%. No more cold draft by supply of high outblow temperatures
- VRV configurator software for the fastest and most accurate commissioning, configuration and customisation
- 3 steps in night quiet mode: step 1: 47dBA, step 2: 44 dBA, step 3: 41 dBA
- Possibility to limit peak power consumption between 30 and 80%, for example during periods with high power demand
- Connectable to all VRV control systems
- Keep your system in top condition via our i-Net service: 24/7 monitoring for maximum efficiency, extended lifetime, immediate service support thanks to failure prediction and a clear understanding of operability and usage



Inverter

2 Specifications

2-1 Technical Specifications					RXYSQ4T8V	RXYSQ5T8V	RXYSQ6T8V	
Capacity range			HP		4	5	6	
Cooling capacity	Nom.	35°CDB	kW		-			
		Eurovent	kW	12.1 (1)	14.0 (1)	15.5 (1)		
Heating capacity	Nom.	6°CWB	kW	12.1 (2)	14.0 (2)	15.5 (2)		
	Max.	6°CWB	kW	14.2 (2)	16.0 (2)	18.0 (2)		
Power input - 50Hz	Cooling	Nom.	35°CDB	kW	-			
			Eurovent	kW	3.03 (1)	3.73 (1)	4.56 (1)	
	Heating	Nom.	6°CWB	kW	2.68 (2)	3.27 (2)	3.97 (2)	
		Max.	6°CWB	kW	3.43 (2)	4.09 (2)	5.25 (2)	
Capacity control	Method			Inverter controlled				
EER at nom. capacity	35°CDB		kW/kW	-				
	Eurovent		kW/kW	4.00 (1)	3.75 (1)	3.40 (1)		
COP at nom. capacity	6°CWB		kW/kW	4.52 (2)	4.28 (2)	3.90 (2)		
COP at max. capacity	6°CWB		kW/kW	4.14 (2)	3.91 (2)	3.43 (2)		
ESEER - Automatic				7.89	7.49	6.73		
ESEER - Standard				6.18	5.77	5.23		
Maximum number of connectable indoor units				64 (3)				
Indoor index connection	Min.			50	62.5	70		
	Nom.			-				
	Max.			130	162.5	182		
Dimensions	Unit	Height	mm	1,345				
		Width	mm	900				
		Depth	mm	320				
	Packed unit	Height	mm	1,524				
		Width	mm	980				
		Depth	mm	420				
Weight	Unit		kg	104				
	Packed unit		kg	114				
Packing	Material			Carton				
	Weight			kg	3.9			
Packing 2	Material			Wood				
	Weight			kg	5.6			
Packing 3	Material			Plastic				
	Weight			kg	0.5			
Casing	Colour			Daikin White				
	Material			Painted galvanized steel plate				
Heat exchanger	Type			Cross fin coil				
	Fin	Treatment		Anti-corrosion treatment				
Compressor	Quantity			1				
	Type			Hermetically sealed swing compressor				
Fan	Quantity			2				
	Air flow rate	Cooling	Nom.	m ³ /min	106			
	External static pressure	Max.		Pa	-			
	Discharge direction			Horizontal				
	Type			Propeller fan				
Fan motor	Quantity			2				
	Output			W	70			
	Model			Brushless DC motor				
Sound power level	Cooling	Nom.	dBA	68 (4)	69 (4)	70 (4)		
Sound pressure level	Cooling	Nom.	dBA	50 (5)	51 (5)			
Operation range	Cooling	Min.~Max.	°CDB	-5~46				
	Heating	Min.~Max.	°CWB	-20~15.5				
Refrigerant	Type			R-410A				
	GWP			2,087.5				
	Charge	TCO ₂ eq		7.5				
		kg		3.6				

2 Specifications

2

2-1 Technical Specifications				RXYSQ4T8V	RXYSQ5T8V	RXYSQ6T8V
Refrigerant oil	Type			Synthetic (ether) oil FVC50K		
	Charged volume		l	1.4		
Piping connections	Liquid	Type		Flare connection		
		OD	mm	9.52		
	Gas	Type		Flare connection		Braze connection
		OD	mm	15.9	19.1	
	Total piping length	System	Actual	m	300 (6)	
Level difference	OU - IU	Outdoor unit in highest position	m	-		
		Indoor unit in highest position	m	-		
Heat insulation				Both liquid and gas pipes		
Defrost method				Reversed cycle		
Safety devices	Item	01		High pressure switch		
		02		Fan driver overload protector		
		03		Inverter overload protector		
		04		PC board fuse		
PED	Category			Category I		
	Most critical part	Name		Compressor		
		Ps*V	Bar*l	167		

Standard Accessories : Installation manual;

Standard Accessories : Operation manual;

Standard Accessories : Connection pipes;

2-2 Electrical Specifications				RXYSQ4T8V	RXYSQ5T8V	RXYSQ6T8V
Power supply	Name			V1		
	Phase			1N~		
	Frequency		Hz	50		
	Voltage		V	220-240		
Voltage range	Min.		%			
	Max.		%			
Current	Nominal running current (RLA) - 50Hz	Cooling	A	14.0 (7)	17.3 (7)	21.2 (7)
Current - 50Hz	Zmax	List		No requirements		
	Minimum circuit amps (MCA)		A	29.1 (8)		
	Maximum fuse amps (MFA)		A	32 (9)		
	Total overcurrent amps (TOCA)		A	29.1 (10)		
	Full load amps (FLA)	Total	A	0.6 (11)		
Wiring connections - 50Hz	For power supply	Quantity		3G		
	For connection with indoor	Quantity		2		
		Remark		F1,F2		
Power supply intake				Both indoor and outdoor unit		

2 Specifications

Notes

(1) Nominal cooling capacities are based on: indoor temperature: 27°CDB, 19°CWB, outdoor temperature: 35°CDB, equivalent refrigerant piping: 5m, level difference: 0m. Data for standard efficiency series. Eurovent 2015 tolerances are used.

(2) Nominal heating capacities are based on: indoor temperature: 20°CDB, outdoor temperature: 7°CDB, 6°CWB, equivalent refrigerant piping: 5m, level difference: 0m. Data for standard efficiency series. Eurovent 2015 tolerances are used.

(3) Actual number of units depends on the indoor unit type (VRV DX indoor, RA DX indoor, etc.) and the connection ratio restriction for the system (being; $50\% \leq CR \leq 130\%$).

(4) Sound power level is an absolute value that a sound source generates.

(5) Sound pressure level is a relative value, depending on the distance and acoustic environment. For more details, please refer to the sound level drawings.

(6) Refer to refrigerant pipe selection or installation manual

(7) RLA is based on following conditions: indoor temp. 27°CDB, 19°CWB; outdoor temp. 35°CDB

(8) MCA must be used to select the correct field wiring size. The MCA can be regarded as the maximum running current.

(9) MFA is used to select the circuit breaker and the ground fault circuit interrupter (earth leakage circuit breaker).

(10) TOCA means the total value of each OC set.

(11) FLA: nominal running current fan

Sound values are measured in a semi-anechoic room.

For detailed contents of standard accessories, see installation/operation manual

MSC means the maximum current during start up of the compressor. VRV IV uses only inverter compressors. Starting current is always \leq max. running current.

Voltage range: units are suitable for use on electrical systems where voltage supplied to unit terminal is not below or above listed range limits.

Maximum allowable voltage range variation between phases is 2%.

Minimum Ssc (=Short-circuit power) value: Equipment complying with EN/IEC 61000-3-12: European/International Technical Standard setting the limits for harmonic currents produced by equipment connected to public low-voltage systems with input current $>16A$ and $\leq 75A$ per phase

The automatic ESEER value corresponds with normal VRV IV-S heat pump operation, including the advanced energy saving functionality (variable refrigerant temperature control).

The standard ESEER value corresponds with normal VRV IV-S heat pump operation, not taking into account the advanced energy saving functionality.

3 Options

3 - 1 Options

3

RXYSQ-T8V

Nr.	Item	RXYSQ4~5TMV1B	RXYSQ4~6T7V1B RXYSQ4~6T8VB	RXYSQ4~6T7Y1B RXYSQ4~6T8YB	RXYSQ8~12TMY1B	RXYSQ6T7Y1B9 RXYSQ6T8Y1B9
I.	Refnet header	KHRQ22M29H				
		-	-	-	KHRQ22M64H	-
II.	Refnet joint	KHRQ22M20T				
		-	-	-	KHRQ22M29T9	-
		-	-	-	KHRQ22M64T	-
1a.	Cool/heat selector (switch)	-	KRC19-26		-	KRC19-26
1b.	Cool/heat selector (fixing box)	-	KJB111A		-	KJB111A
1c.	Cool/heat selector (PCB)	-	EBRP2B	-	-	-
1d.	Cool/heat selector (cable)	-	-	EKCHSC	-	EKCHSC
2.	Drain plug kit	-	EKDK04		-	EKDK04
3.	VRV configurator	EKPCAB*				
4.	Demand PCB	DTA104A61/62*				
5.	Branch provider - 2- rooms	BPMKS967A2				-
6.	Branch provider - 3- rooms	BPMKS967A3				-

Notes

1. All options are kits
2. To mount option -1a-, option -1b- is required.
3. For -RXYSQ4~6T7V1B-
For -RXYSQ4~6T8VB-
To operate the cool/heat selector function, options -1a- and -1c- are both required.
4. For -RXYSQ4~6T7Y1B-
For -RXYSQ4~6T8YB-
To operate the cool/heat selector function, options -1a- and -1d- are both required.

3D097778B

4 Combination table

4 - 1 Combination Table

RXYSQ-T8V

Configuration		Indoor unit type	
-RA- indoor unit	Wall-mounted	Emura	FTXG20L (W/S)
			FTXG25L (W/S)
			FTXG35L (W/S)
			FTXG50L (W/S)
		FTXS	FTXS20K
			FTXS25K
			FTXS35K
			FTXS42K
			FTXS50K
			FTXS60G
		CTXS	FTXS71G
			CTXS15K
			CTXS35K
	Floor-standing	Flex	FLXS25B
	Ceiling-mounted		FLXS35B
			FLXS50B
			FLXS60B
	Floor-standing	FVXS	FVXS25F
			FVXS35F
			FVXS50F
		Nexura	FVXG25K
			FVXG35K
			FVXG50K
		FNQ	FNQ25A
			FNQ35A
			FNQ50A
			FNQ60A
Duct		FDXS	FDXS25F
			FDXS30F
			FDXS50F9
			FDXS60F

Configuration		Indoor unit type	
-SA- indoor unit	Cassette	Fully Flat 2x2	FFQ25C
			FFQ35C
			FFQ50C
		Roundflow 3x3	FFQ60C
			FCQG35F
			FCQG50F
	Ceiling-suspended		FCQG60F
			FCQG71F
			FHQ35C
			FHQ50C
	Duct		FHQ60C
			FHQ71C
			FBQ35D
			FBQ50D
	FBQ60D		
	FBQ71D		

3D097777A

RXYSQ-T8V

Combination table	RXYSQ4~5TMV1B	RXYSQ4~6T7V1B	RXYSQ4~6T7Y1B	RXYSQ8~12TMY1B
-VRV* DX- indoor unit	O	O	O	O
-RA DX- indoor unit	O	O	O	O
Hydrobox unit	X	X	X	X
Air handling unit (AHU) (2)	O	O	O	O

O: Allowed
X: Not allowed

Notes

- (2) The following units are considered AHUs:
 - -EKE XV + EKEQ(MA/FA) + AHU- coil
 - -Biddle- air curtain
 - -FXMQ_MF- units

3D097983

5 Capacity tables

5 - 1 Capacity Table Legend

5

In order to fulfill more your requirements on quick access of data in the format you require, we have developed a tool to consult capacity tables.

Below you can find the link to the capacity table database and an overview of all the tools we have to help you select the correct product:

- Capacity table database: lets you find back and export quickly the capacity information you are looking for based upon unit model, refrigerant temperature and connection ratio.

[Click here to access the capacity table viewer.](#)



- For more information about all our tools we offer [click here to see the overview](#) on my.daikin.eu



5 Capacity tables

5 - 2 Integrated Heating Capacity Correction Factor

RXYSQ-T8V

MINI VRV

Integrated heating capacity coefficient

The heating capacity tables do not take into account the capacity reduction in case of frost accumulation or defrost operation. The capacity values that take these factors into account, or in other words, the integrated heating capacity values, can be calculated as follows:

Formula

- A = Integrated heating capacity
- B = Capacity characteristics value
- C = Integrated correction factor for frost accumulation (see table)

$$A = B \cdot C$$

Inlet air temperature of heat exchanger

[°CDB/°CWB]	-7/-7.6	-5/-5.6	-3/-3.7	0/-0.7	3/2.2	5/4.1	7/6
RXYSQ4TMV1B							
RXYSQ5TMV1B							
RXYSQ4T7V1B							
RXYSQ5T7V1B							
RXYSQ6T7V1B							
RXYSQ4T7Y1B							
RXYSQ5T7Y1B							
RXYSQ6T7Y1B							
RXYSQ6T7Y1B9	0,88	0,86	0,80	0,75	0,76	0,82	1,00
RXYSQ4T8VB							
RXYSQ5T8VB							
RXYSQ6T8VB							
RXYSQ4T8YB							
RXYSQ5T8YB							
RXYSQ6T8YB							
RXYSQ6T8Y1B9							
RXYSQ8TMY1B	0,95	0,93	0,88	0,84	0,85	0,90	1,00
RXYSQ10TMY1B	0,95	0,93	0,87	0,79	0,80	0,88	1,00
RXYSQ12TMY1B	0,95	0,92	0,87	0,75	0,76	0,85	1,00

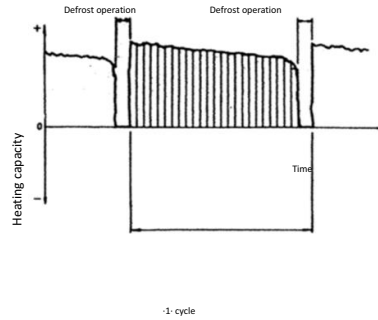

Notes

- (1) The figure shows the integrated heating capacity for a single cycle (from one defrost operation to the next).
- (2) When there is an accumulation of snow against the outdoor unit heat exchanger, there will always be a temporary reduction in capacity depending on the outdoor temperature (°CDB), relative humidity (RH) and the amount of frosting which occurs.

3D094659A

5 Capacity tables

5 - 3 Capacity Correction Factor

5 Capacity tables

5 - 3 Capacity Correction Factor

RXYSQ-T8V

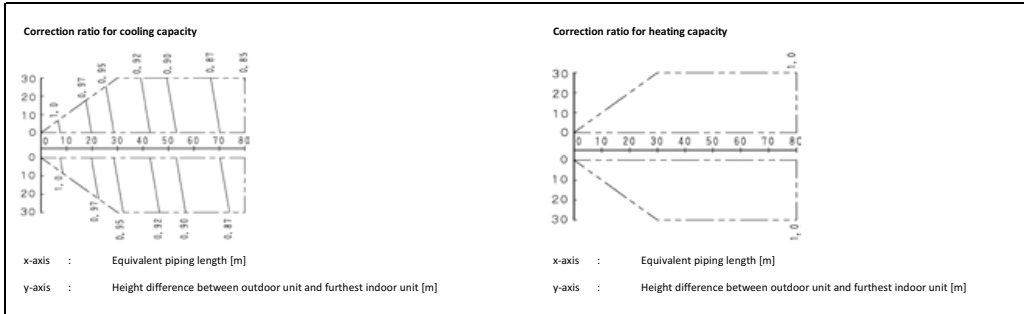

Notes

- These figures illustrate the capacity correction factor due to the piping length for a standard indoor unit system at maximum load (with the thermostat set to maximum), under standard conditions. Moreover, under partial load conditions, there is only a minor deviation for the capacity correction ratio, as shown in the above figures.

With this outdoor unit, the following control is used:

- in case of cooling: constant evaporating pressure control
- in case of heating: constant condensing pressure control

3. Method of calculating the capacity of the outdoor units.

The maximum capacity of the system will be either the total capacity of the indoor units or the maximum capacity of the outdoor units as mentioned below, whichever is less.

Indoor connection ratio ≤ 100%.

$$\text{Maximum capacity of outdoor units} = \text{Capacity of outdoor units from capacity table at 100\% connection ratio.} \times \text{Correction ratio of piping to furthest indoor unit}$$

Indoor connection ratio > 100%.

$$\text{Maximum capacity of outdoor units} = \text{Capacity of outdoor units from capacity table at installed connection ratio.} \times \text{Correction ratio of piping to furthest indoor unit}$$

- When the overall equivalent piping length is 90 m or more, the diameter of the main gas pipes (outdoor unit - branch sections) must be increased.

For the new diameters, see below.

Model	Standard liquid side Ø	Increased liquid side Ø	Standard gas side Ø	Increased gas side Ø
4HP / 5HP	9,5	Not increased	15,9	19,1
6 HP	9,5	Not increased	19,1	22,2

5. Overall equivalent length

$$\text{Overall equivalent length} = \text{Equivalent length of the main pipe} \times \text{Correction factor} + \text{Equivalent length of the branch pipes}$$

Choose the correction factor from the following table.

When calculating the cooling capacity: gas pipe size

When calculating the heating capacity: liquid pipe size

	Standard size	Size increase
Cooling (gas pipe)	1,0	0,5
Heating (liquid pipe)	1,0	0,5

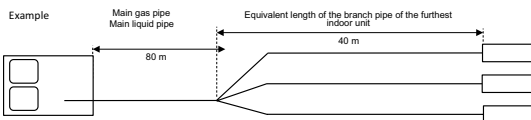

- Overall equivalent length
- Cooling mode = 80 m x 0,5 + 40 m = 80 m
 - Heating mode = 80 m x 0,5 + 40 m = 80 m
- Capacity correction ratio (height difference = 0)
- Cooling mode = 0,86
 - Heating mode = 1,00

3D094660A

6 Dimensional drawings

6 - 1 Dimensional Drawings

RXYSQ-T8V

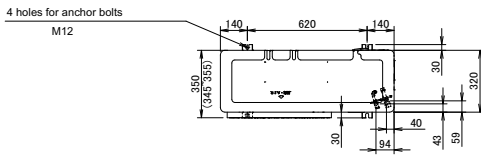

1	Gas pipe connection A
2	Liquid pipe connection Ø9.5 flare
3	(2X) Service port (in the unit)
4	Electronic connection and grounding terminal M5 (in the switch box)
5	Refrigerant piping intake
6	Power supply wiring intake (knockout hole Ø34)
7	Control wiring intake (knockout hole Ø27)
8	Drain outlet

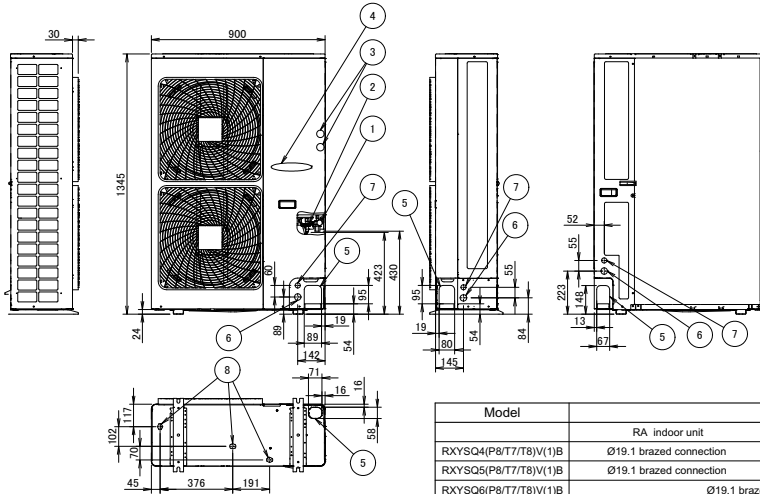

Model	A
RMXS112E8V1B	Ø19.1 brazed connection
RMXS140E8V1B	Ø19.1 brazed connection
RMXS160E8V1B	Ø19.1 brazed connection
RXYSQ4PA7Y1B	Ø15.9 flared connection
RXYSQ5PA7Y1B	Ø15.9 flared connection
RXYSQ6PA7Y1B	Ø19.1 brazed connection
ERX100A9V1B	Ø15.9 flared connection
ERX125A9V1B	Ø15.9 flared connection
ERX140A9V1B	Ø19.1 brazed connection
GCA100BD4	Ø15.9 flared connection
GCA125BD4	Ø15.9 flared connection
GCA140BD4	Ø19.1 brazed connection
RXYSQ4PA7Y1B	Ø15.9 flared connection
RXYSQ5PA7Y1B	Ø15.9 flared connection
RXYSQ6PA7Y1B	Ø19.1 brazed connection

Model	A	
	RA indoor unit	VRV indoor unit
RXYSQ4(P8/T7/T8)V(1)B	Ø19.1 brazed connection	Ø15.9 flared connection
RXYSQ5(P8/T7/T8)V(1)B	Ø19.1 brazed connection	
RXYSQ6(P8/T7/T8)V(1)B	Ø19.1 brazed connection	
RXYSQ4(P8/T7/T8)Y(1)B	Ø19.1 brazed connection	Ø15.9 flared connection
RXYSQ5(P8/T7/T8)Y(1)B	Ø19.1 brazed connection	
RXYSQ6(P8/T7/T8)Y(1)B	Ø19.1 brazed connection	

3TW303741E

7 Centre of gravity

7 - 1 Centre of Gravity

RXYSQ-T8V

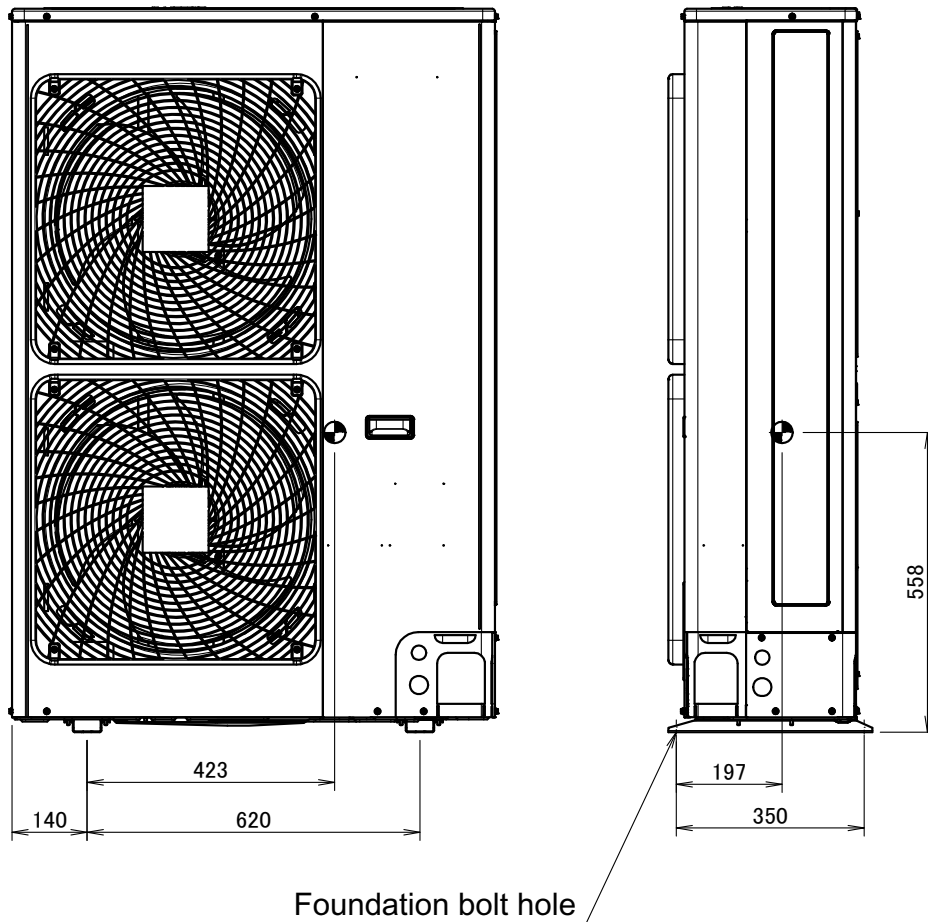

4D094634

8 Piping diagrams

8 - 1 Piping Diagrams

8

RXYSQ-T8V

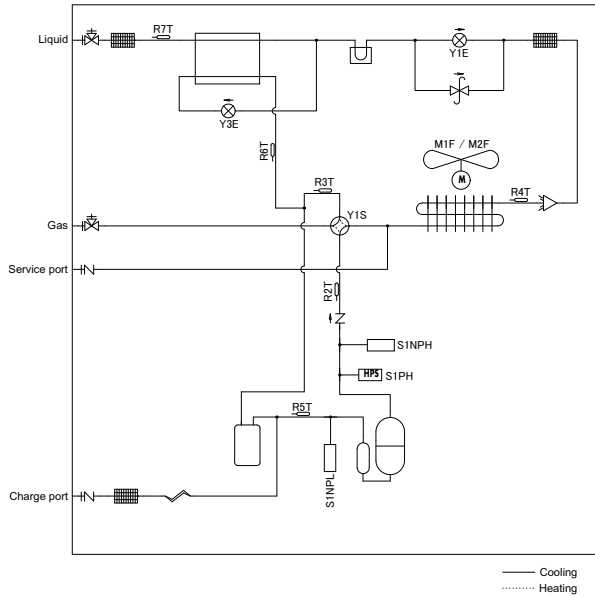

- Charge port / Service port
- Stop valve
- Filter
- Check valve
- Pressure relief valve
- Thermistor
- Heat sink (PCB)
- Capillary tube
- Expansion valve
- 4-way valve
- Propeller fan
- High pressure switch
- Low pressure sensor
- High pressure sensor
- Accumulator
- Heat exchanger
- Compressor
- Compressor Accumulator
- Double tube heat exchanger
- Distributor

3D094630A

9 Wiring diagrams

9 - 1 Wiring Diagrams - Single Phase

RXYSQ-T8V

NOTES TO GO THROUGH BEFORE STARTING THE UNIT

- 1: Symbols
 X1M : Main terminal
- : Earth wiring
 15 : Wire number 15
 - - - : Field wire
 - · - · - : Field cable
 → **/12.2 : Connection ** continues on page 12 column 2
 ① : Several wiring possibilities

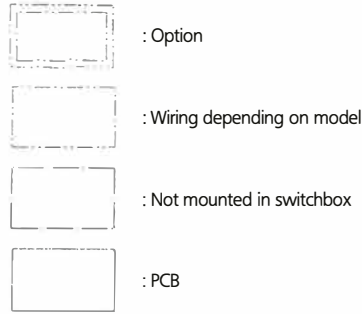

- 2: For X37A refer to the installation manual of the option.
 3: Refer to the installation or service manual on how to use BS1-BS4 push buttons and DS1-1 - DS1-2 DIP switches.
 4: Do not operate the unit by short-circuiting protection device S1PH.
 5: Refer to the installation manual for indoor-outdoor transmission F1-F2 wiring.
 6: When using the central control system, connect outdoor-outdoor transmission F1-F2.

LEGEND

- * : Optional
 # : Field supply
- A1P : Main PCB
 A2P : filter PCB
 A3P * : Cool / heat selector PCB
 BS* (A1P) : Push buttons (Mode, set, return, test, reset)
 C1 (A1P) : Capacitor
 DS1 (A1P) : Dipswitch
 F1U (A2P) : Fuse T56A 250V
 F3U (A2P) : Fuse T6.3A 250V
 F4U (A2P) : Fuse T6.3A 250V
 F6U (A1P) : Fuse T5A 250V
 HAP (A1P) : running LED (Service monitor-green)
 HBP (A1P) : frequency LED (Service monitor-green)
 H*P (A1) : LED (Service monitor-orange)
 K11M (A1P) : Magnetic contactor
 K*R (A1P) : Magnetic relay
 L*R (A1P) : Reactor
 M1C : Motor (compressor)
 M1F : Fan motor (upper)
 M2F : Fan motor (lower)
 PS (A1P) : Switching power supply
 Q1DI # : Earth leakage circuit breaker
 R* (A1P) : Resistor
 R1T : Thermistor (Air)
 R2T : Thermistor (Discharge)
 R3T : Thermistor (Suction 1)
 R4T : Thermistor (Heat exchanger)
 R5T : Thermistor (Suction 2)
 R6T : Thermistor (subcool heat exchanger)
 R7T : Thermistor (Liquid)
 FINTH : Thermistor (Fin)
 S1NPH : High pressure sensor
 S1NPL : Low pressure sensor
 S1PH : High pressure switch
 S1S * : Air control switch
 S2S * : Cool / heat switch
 V1R (A1P) : IGBT power module
 V2R (A1P) : Diode module
 V*T (A1P) : IGBT N-channel
 V*D (A1P) : Diodes
 X37A : Connector (power supply for option PCB)
 X*A : PCB connector
 X*M : Terminal strip
 X*Y : Connector
 Y1E : Electronic expansion valve (Main)
 Y3E : Electronic expansion valve (Subcool)
 Y1S : Solenoid valve (4-way valve)
 Z1C~Z7C : Noise filter (ferrite core)
 Z*F (A*P) : Noise filter

POSITION IN SWITCHBOX

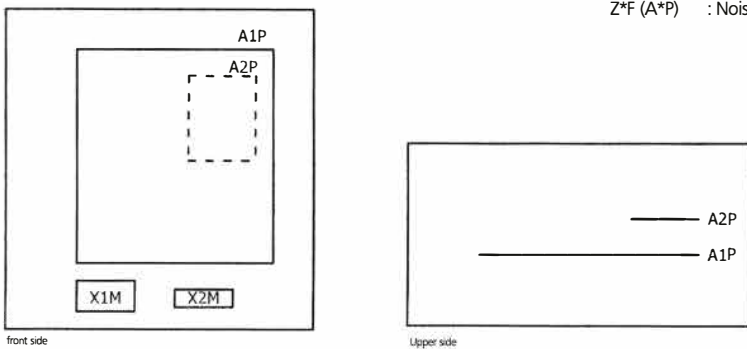

4D094013

9 Wiring diagrams

9 - 1 Wiring Diagrams - Single Phase

9

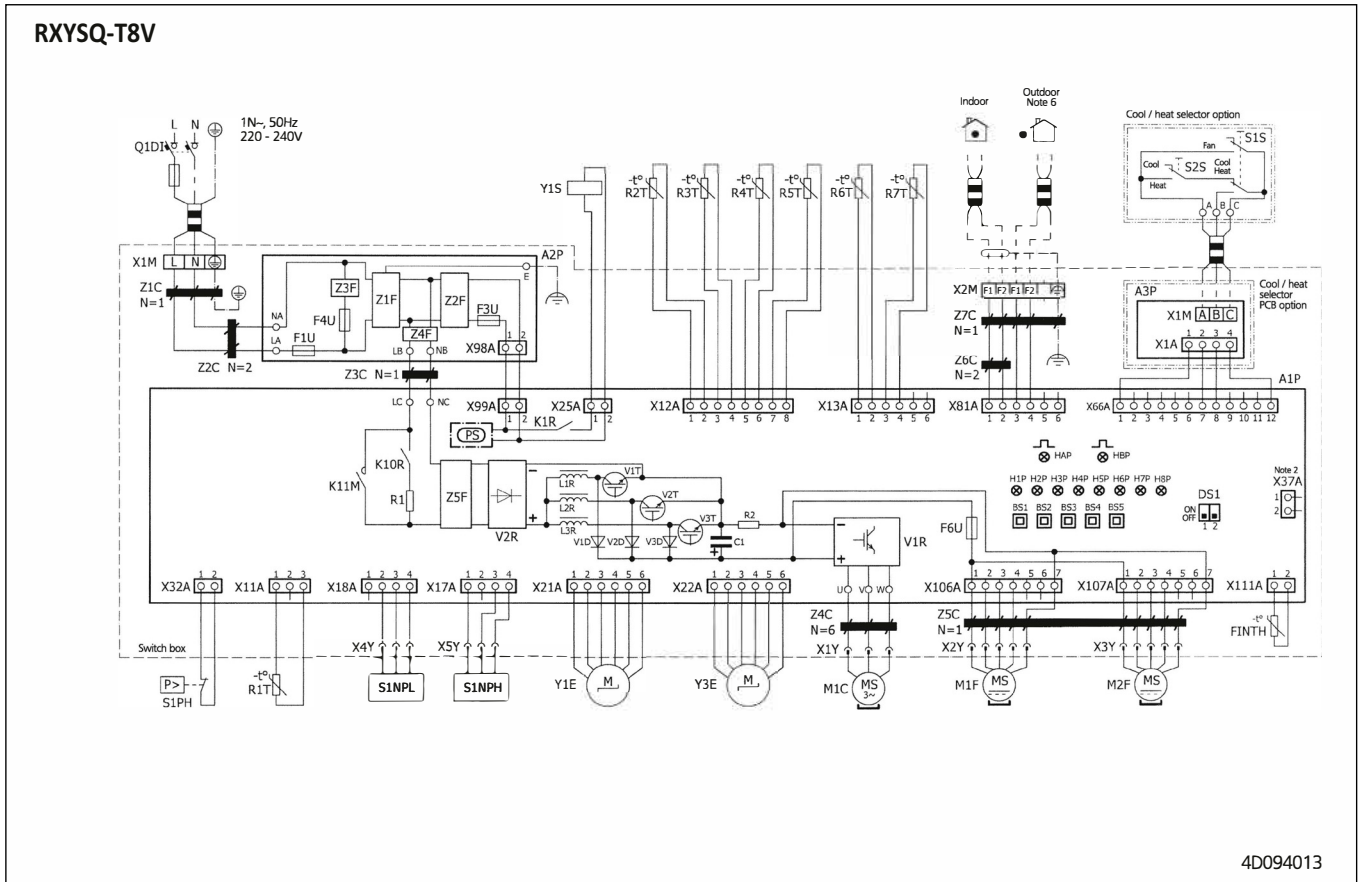

10 External connection diagrams

10 - 1 External Connection Diagrams

RXYSQ-T8V

External connection diagram

VRV indoor unit

Notes

1. All wiring, components and materials to be procured on-site must comply with the applicable legislation.
2. Use copper conductors only.
3. For more details, refer to the wiring diagram of the unit.
4. Install a circuit breaker for safety.
5. All field wiring and components must be provided by an authorised electrician.
6. Unit has to be grounded in compliance with the applicable legislation.
7. The wiring shown is a general points-of-connection guide and is not intended to include all details for a specific installation.
8. Make sure to install the switch and the fuse to the power line of each equipment.
9. Install a main switch to (if necessary) immediately interrupt all the system's power sources.
10. Install an earth leakage circuit breaker.
11. To ensure proper earthing, connect the shields of the incoming and outgoing transmission wiring of each indoor unit (or each BP box, depending on the system layout) to each other.

BP box + RA/SA indoor unit

Power source is supplied to each BP box individually.

Power source is connected in series between the units.

10094666

11 Sound data

11 - 1 Sound Level Data

11

RXYSQ4T8V

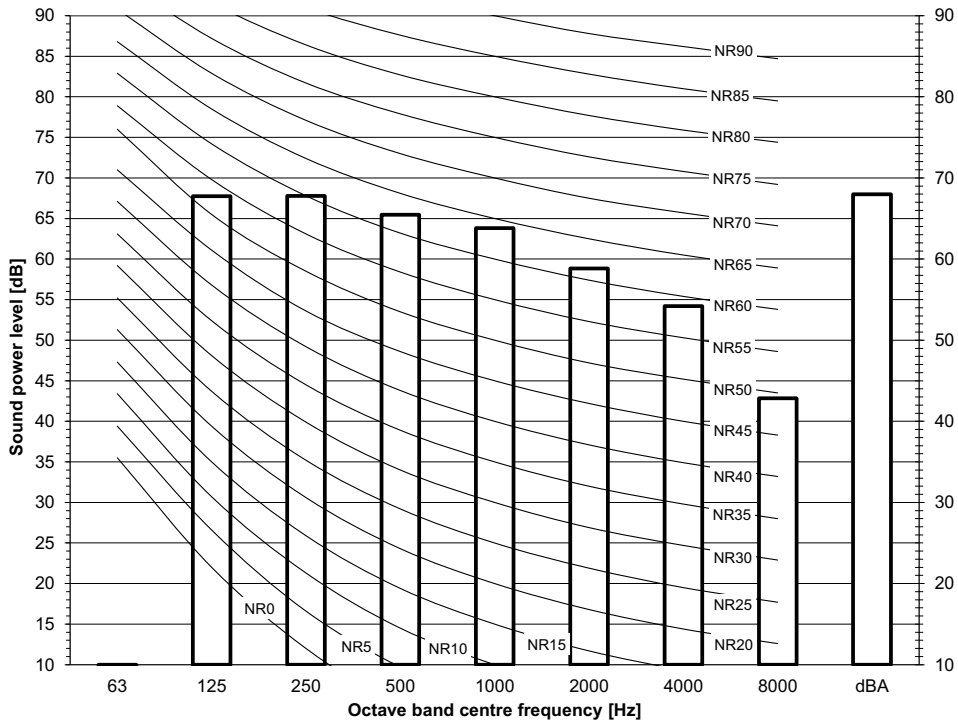

Notes
 - dBA = A-weighted sound power level (A scale according to IEC).
 - Reference acoustic intensity 0dB = -10E-6μW/m².
 - Measured according to ISO 3744

3D098212

RXYSQ5T8V

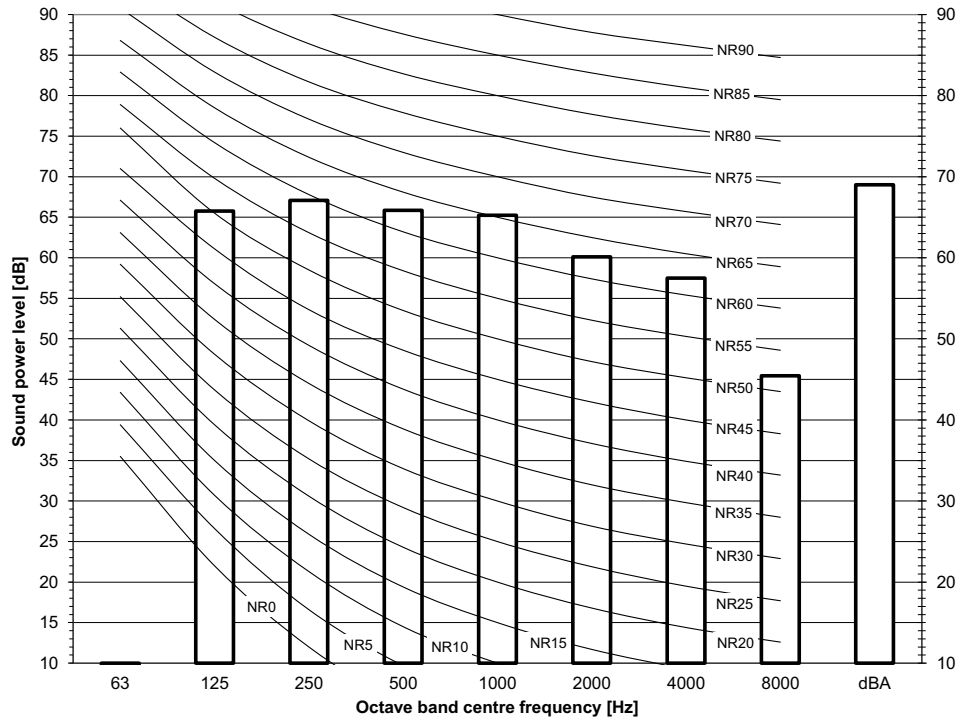

Notes
 - dBA = A-weighted sound power level (A scale according to IEC).
 - Reference acoustic intensity 0dB = -10E-6μW/m².
 - Measured according to ISO 3744

3D098213

11 Sound data

11 - 1 Sound Level Data

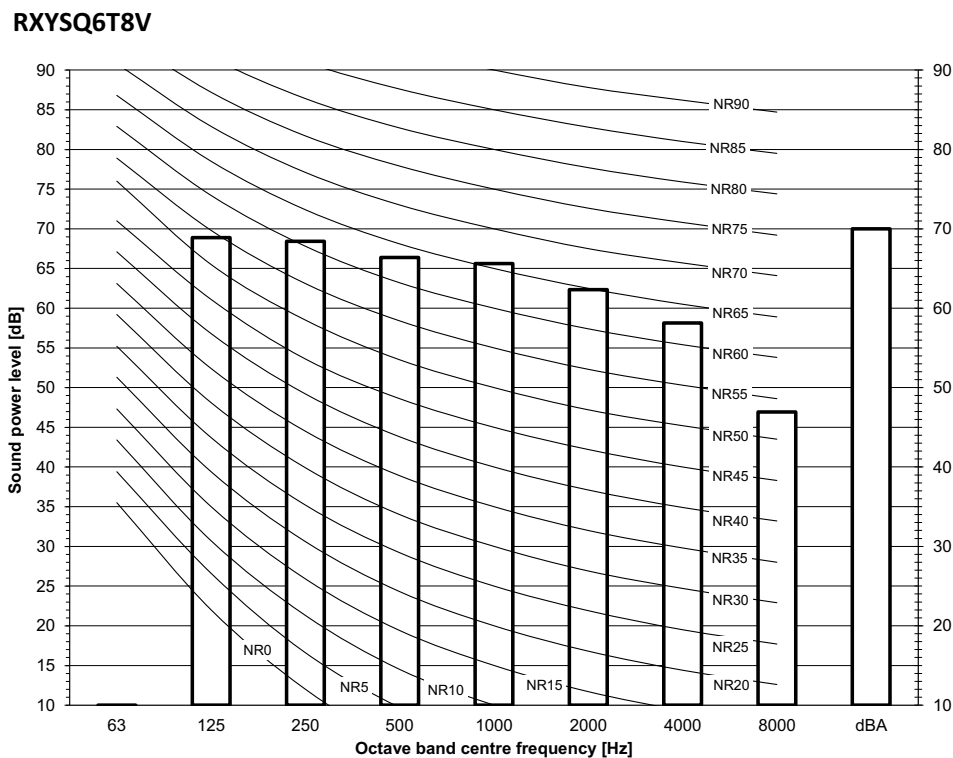

Notes
 - dBA = A-weighted sound power level (A scale according to IEC).
 - Reference acoustic intensity $0dB = 10E-6\mu W/m^2$.
 - Measured according to ISO 3744

3D098214

11 Sound data

11 - 2 Sound Pressure Spectrum

11

RXYSQ4T8V

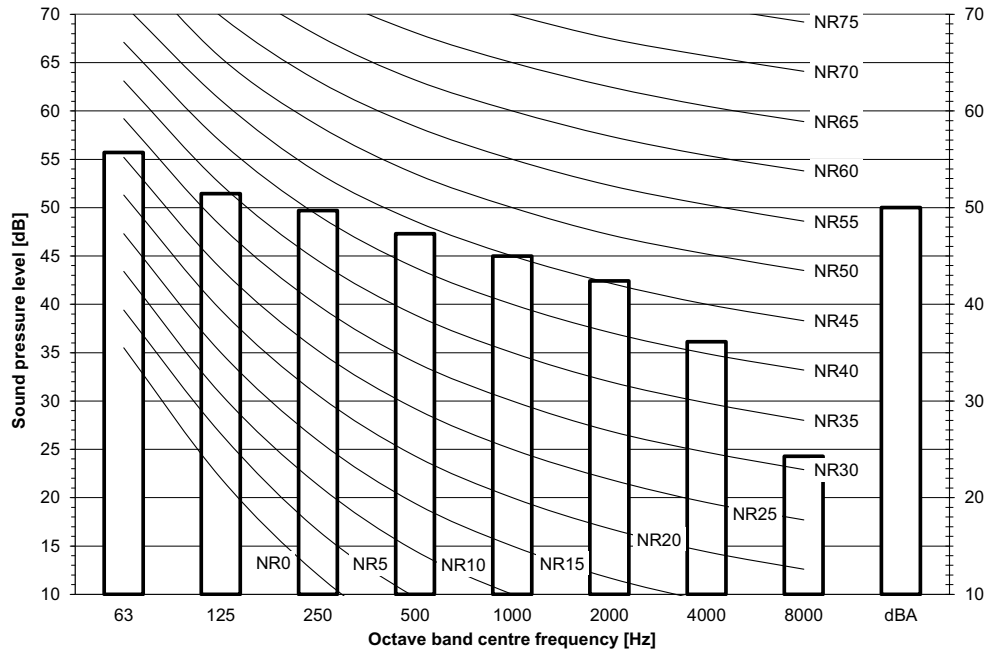

- Notes**
- Data is valid at free field condition.
 - Data is valid at nominal operation condition.
 - dBA = A-weighted sound pressure level (A scale according to IEC).
 - Reference acoustic pressure 0 dB = 20 μPa

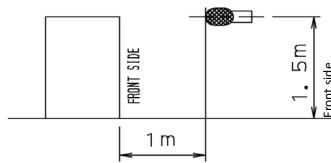

3D098215

RXYSQ5T8V

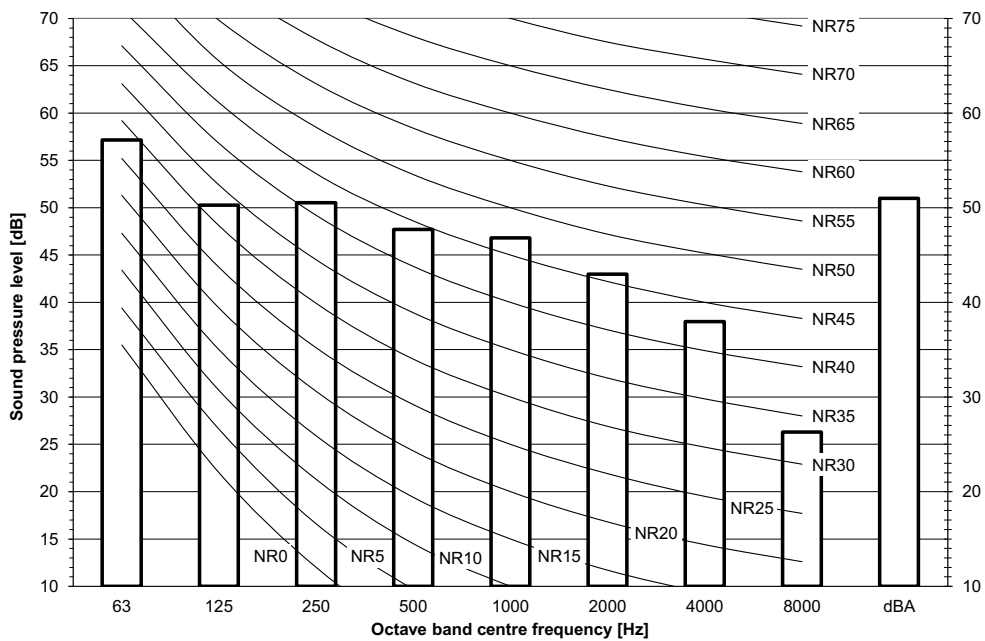

- Notes**
- Data is valid at free field condition.
 - Data is valid at nominal operation condition.
 - dBA = A-weighted sound pressure level (A scale according to IEC).
 - Reference acoustic pressure 0 dB = 20 μPa

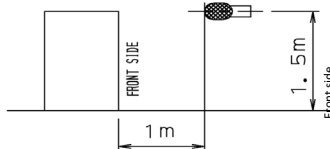

3D098216

11 Sound data

11 - 2 Sound Pressure Spectrum

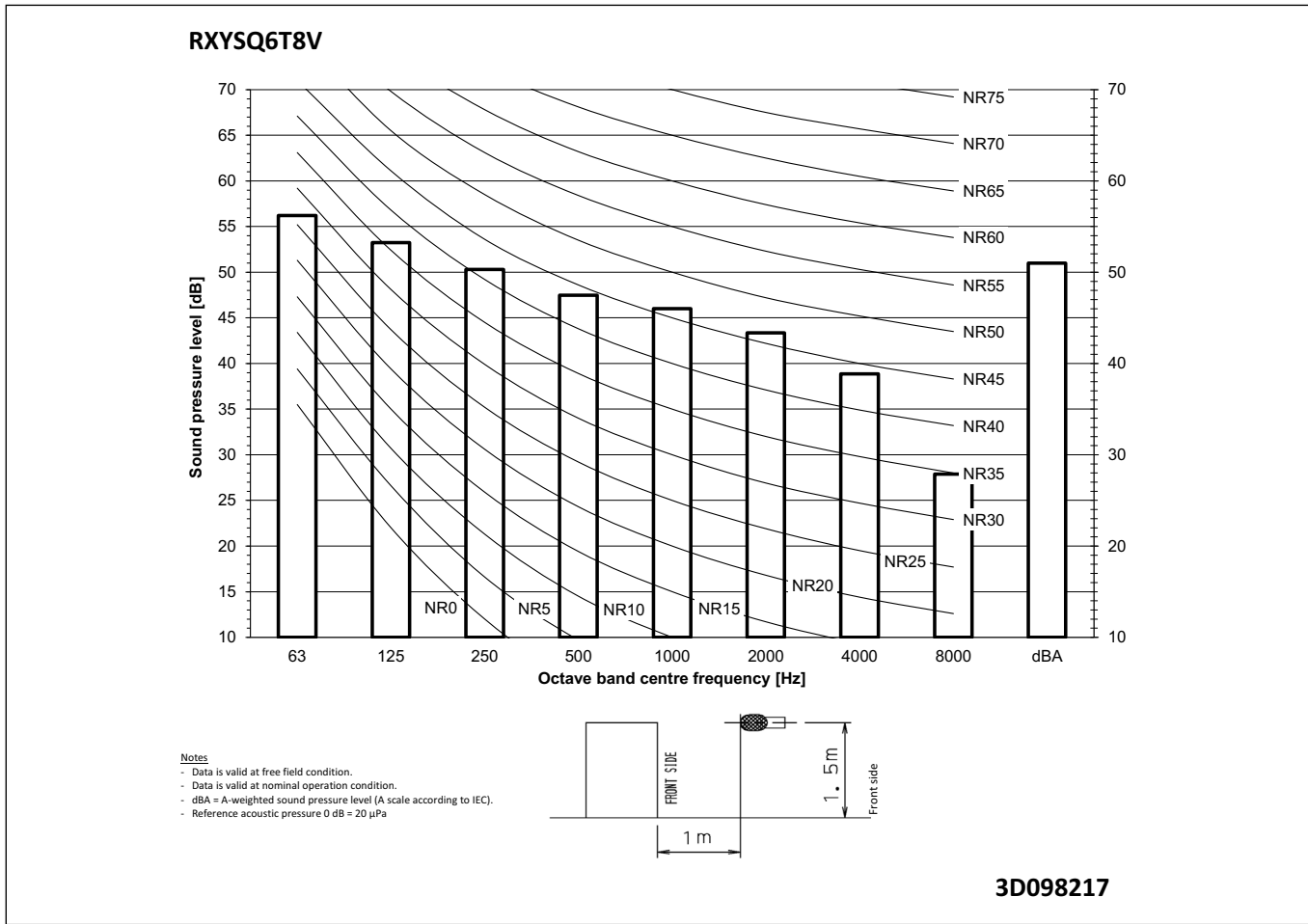

12 Installation

12 - 1 Installation Method

RXYSQ-T8V

Required installation space

The unit of the values is mm.

(A) When there are obstacles on suction sides.

• No obstacle above

- ① Stand-alone installation
 - Obstacle on the suction side only

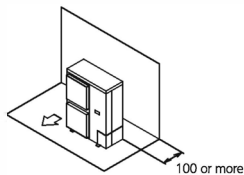

- Obstacle on both sides

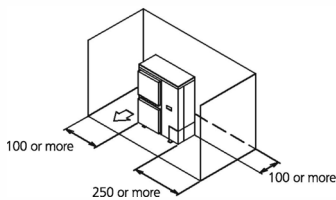

- ② Series installation (2 or more)
 - Obstacle on both sides

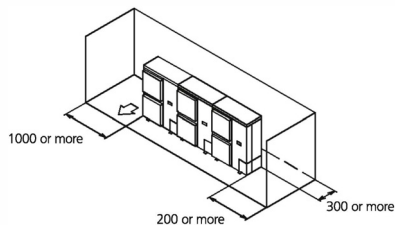

• Obstacle above, too.

- ① Stand-alone installation
 - Obstacle on the suction side, too

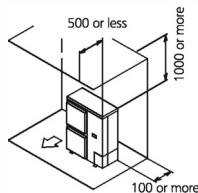

- Obstacle on the suction side and both sides

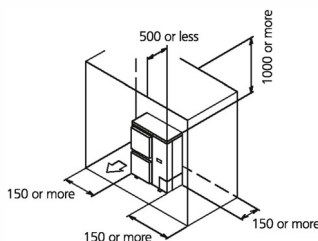

- ② Series installation (2 or more)
 - Obstacle on the suction side and both sides

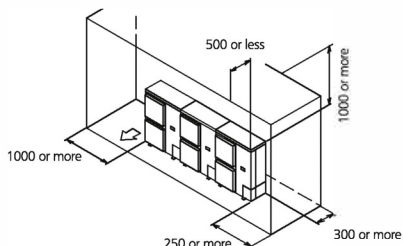

(B) When there are obstacles on discharge sides.

• No obstacle above

- ① Stand-alone installation

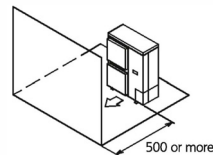

- ② Series installation (2 or more)

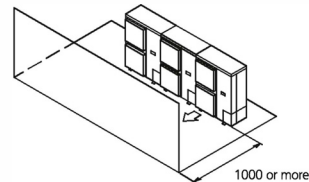

• Obstacle above, too

- ① Stand-alone installation

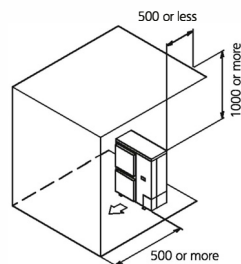

- ② Series installation (2 or more)

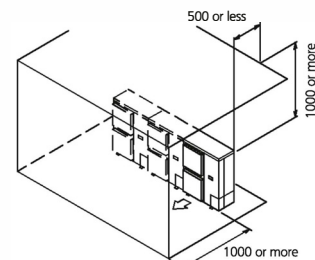

(C) When there are obstacles on both suction and discharge sides.:

Pattern 1

When the obstacles on the discharge side is higher than the unit.
(There is no height limit for obstructions on the intake side.)

• No obstacle above

- ① Stand-alone installation

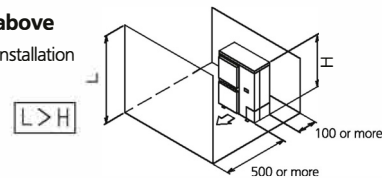

- ② Series installation (2 or more)

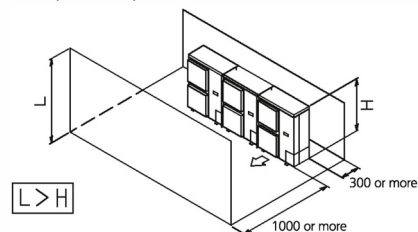

3D045696D

12 Installation

12 - 1 Installation Method

RXYSQ-T8V

● **Obstacle above, too**

① Stand-alone installation

The relations between H, A and L are as follows.

	L	A
$L \leq H$	$0 < L \leq 1/2 H$	750
	$1/2 H < L \leq H$	1000
$H < L$	Set the stand as: $L \leq H$	

Close the bottom of the installation frame to prevent the discharged air from being bypassed.

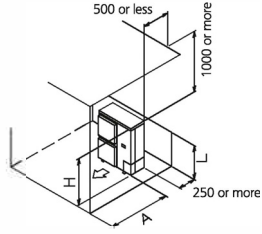

② Series installation (2 or more)

The relations between H, A and L are as follows.

	L	A
$L \leq H$	$0 < L \leq 1/2 H$	1000
	$1/2 H < L \leq H$	1502
$H < L$	Set the stand as: $L \leq H$	

Close the bottom of the installation frame to prevent the discharged air from being bypassed. Only two units can be installed for this series.

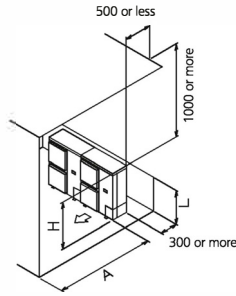

Pattern 2

When the obstacle on the discharge side is lower than the unit:
(There is no height limit for obstructions on the intake side.)

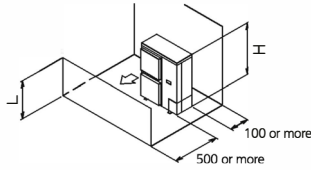

● **No obstacle above**

① Stand-alone installation

$L \leq H$

② Series installation (2 or more)

The relations between H, A and L are as follows.

	L	A
$L \leq H$	$0 < L \leq 1/2 H$	250
	$1/2 H < L \leq H$	300

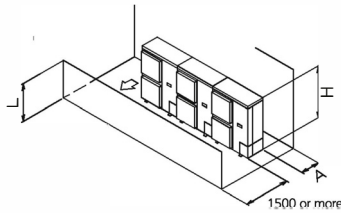

● **Obstacle above, too**

① Stand-alone installation

The relations between H, A and L are as follows.

	L	A
$L \leq H$	$0 < L \leq 1/2 H$	100
	$1/2 H < L \leq H$	200
$H < L$	Set the stand as: $L \leq H$	

Close the bottom of the installation frame to prevent the discharged air from being bypassed.

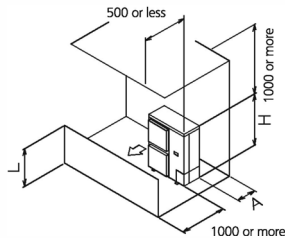

② Series installation

The relations between H, A and L are as follows.

	L	A
$L \leq H$	$0 < L \leq 1/2 H$	250
	$1/2 H < L \leq H$	300
$H < L$	Set the stand as: $L \leq H$	

Close the bottom of the installation frame to prevent the discharged air from being bypassed. Only two units can be installed for this series.

(D) Double-decker installation

① Obstacle on the discharge side.

Close the gap A (the gap between the upper and lower outdoor units) to prevent the discharged air from being bypassed. Do not stack more than two unit.

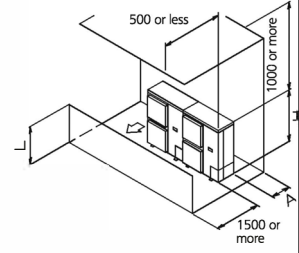

② Obstacle on the suction side.

Close the gap A (the gap between the upper and lower outdoor units) to prevent the discharged air from being bypassed. Do not stack more than two unit.

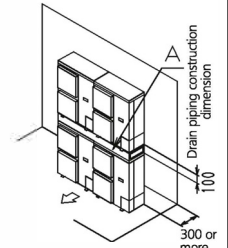
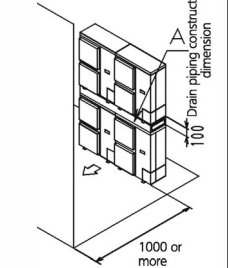

(E) Multiple rows of series installation (on the rooftop, etc.)

① One row of stand-alone installation

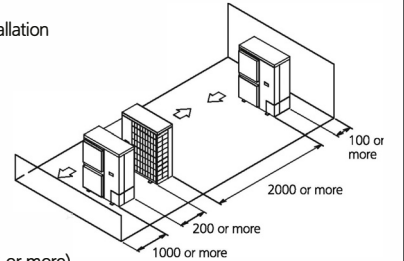

② Rows of series installation (2 or more)

The relations between H, A and L are as follows.

	L	A
$L \leq H$	$0 < L \leq 1/2 H$	250
	$1/2 H < L \leq H$	300
$H < L$	Can not be installed	

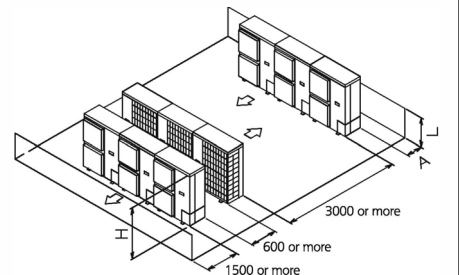

3D045696D

12 Installation

12 - 2 Refrigerant Pipe Selection

RXYSQ-T8V

For the reference drawing, see page 2/3.

		Maximum piping length		Maximum height difference		Total piping length
		Longest pipe (A+[B,D+E,H]) Actual / (Equivalent)	After first branch (B,D+E,H) Actual	Indoor-to-outdoor (H1) Outdoor above indoor / (indoor above outdoor)	Indoor-to-indoor (H2)	
Standard	RXYSQ4~5TMV1B	70/(90)m	40m	30/(30)m	15m	300m
	RXYSQ4~6T7(V/Y)1B	120/(150)m	40m	50/(40)m	15m	300m
	RXYSQ4~6T8(V/Y)B					
	VRV DX- indoor units only	RXYSQ8TMY1B	100/(130)m	40m	50/(40)m	15m
RXYSQ10~12TMV1B		120/(150)m	40m	50/(40)m	15m	300m
RA- connection	RXYSQ4~5TMV1B	35/(45)m	40m	30/(30)m	15m	140m
	RXYSQ4~6T7(V/Y)1B	65/(85)m	40m	30/(30)m	15m	140m
	RXYSQ4~6T8(V/Y)B					
	RXYSQ8TMY1B	80/(100)m	40m	30/(30)m	15m	140m
RXYSQ10~12TMV1B	80/(100)m	40m	30/(30)m	15m	140m	
Air handling unit (-AHU-) connection	Pair	50/(55)m (1)	-	40/(40)m	-	-
	Multi (2)	50/(55)m (1)	40m	40/(40)m	15m	300m
	Mix (3)	50/(55)m (1)	40m	40/(40)m	15m	300m

Notes

- The allowable minimum length is 5 m.
- Multiple air handling units (-AHU-)(-EKEV- + -EKEQ- kits).
- Mix of air handling units (-AHU-) and -VRV DX- indoor units.

3D097984A

RXYSQ-T8V

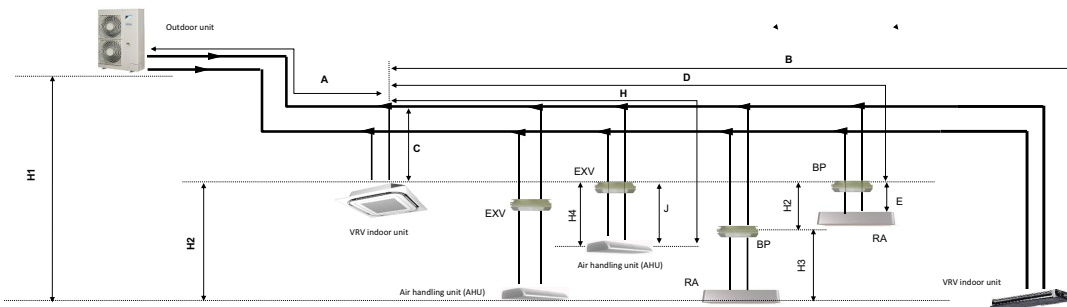

Notes

- Schematic indication. Illustrations may differ from the actual appearance of the unit.
- This is only to illustrate piping length limitations. Refer to combination table 3D097983 for details about the allowed combinations.

		Allowed piping length		Maximum height difference	
		BP- to -RA- (E)	-EXV- to -AHU- (J)	-BP- to -RA- (H3)	-EXV- to -AHU- (H4)
RA- connection	Pair	2~15m	-	5m	-
	Multi (1)	-	≤5m	-	5m
Air handling unit (AHU) Connection	Multi (1)	-	≤5m	-	5m
	Mix (2)	-	≤5m	-	5m

Notes

- Multiple air handling units (-AHU-)(-EKEV- + -EKEQ- kits).
- Mix of air handling units (-AHU-) and -VRV DX- indoor units.

3D097984A

12 Installation

12 - 2 Refrigerant Pipe Selection

RXYSQ-T8V

System pattern Allowed connection ratio (CR) Other combinations are not allowed.	Total		Allowed capacity		
	Capacity	Maximum allowed amount of connectable indoor units (-VRV, RA, AHU-) Excluding -BP- units and including -EXV- kits.	VRV DX indoor unit	-RA DX- indoor unit	Air handling unit (AHU)
-VRV DX- indoor units only	50~130%	Maximum -64-	50~130%	-	-
-RA DX- indoor units only	80~130%	Maximum -32- (1)	-	80~130%	-
-VRV DX- indoor unit + -AHU- Mix	50~110% (3)	Maximum -64- (2)	50~110%	-	0~110%
-AHU- only Pair + multi (4)	90~110% (3)	Maximum -64- (2)	-	-	90~110%

Notes

1. There is no restriction on the number of connectable -BP- boxes.
2. -EKEXV- kits are also considered indoor units.
3. Restrictions regarding the air handling unit capacity
4. Pair AHU = system with 1 air handling unit connected to one outdoor unit
Multi AHU = system with multiple air handling units connected to one outdoor unit

About ventilation applications

- I. -FXMQ_MF- units are considered air handling units, following air handling unit limitations.
 - Maximum connection ratio when combined with -VRV DX- indoor units: -CR ≤ 30-%.
 - Maximum connection ratio when only air handling units are connected: -CR ≤ 100-%.
 - Minimum connection ratio when only -FXMQ_MF- units are connected: -CR ≥ 50-%.
 For information on the operation range, refer to the documentation of the -FXMQ_MF- unit.
- II. -Biddle- air curtains are considered air handling units, following air handling unit limitations:
For information on the operation range, refer to the documentation of the -Biddle- unit.
- III. -EKEXV + -EKEQ- units combined with an air handling unit are considered air handling units, following air handling unit limitations.
For information on the operation range, refer to the documentation of the -EKEXV-EKEQ- unit.
- IV. -VKM- units are considered to be regular -VRV DX- indoor units.
For information on the operation range, refer to the documentation of the -VKM- unit.
- V. Because there is no refrigerant connection with the outdoor unit (only communication F1/F2), -VAM- units do not have connection limitations.
However, since there is communication via F1/F2, count them as regular indoor unit when calculating the maximum allowed number of connectable indoor units.

3D097984A

13 Operation range

13 - 1 Operation Range

13

RXYSQ-T8V

Notes

- These figures assume the following operation conditions
 Indoor and outdoor units
 Equivalent piping length: 5m
 Level difference: 0m
- Depending on operation and installation conditions, the indoor unit can change over to freeze-up operation (indoor de-icing).
- To reduce the freeze-up operation (indoor de-icing) frequency, it is recommended to install the outdoor unit in a location not exposed to wind.
- Operation range is valid in case direct expansion indoor units are used.
 If other indoor units are used, refer to the documentation of the respective indoor units.
- If the unit is selected to operate at ambient temperatures <-5°C for 5 days or more, with relative humidity levels >95%, it is recommended to apply a Daikin range specifically designed for such application.
 For more information, contact your dealer.

Cooling

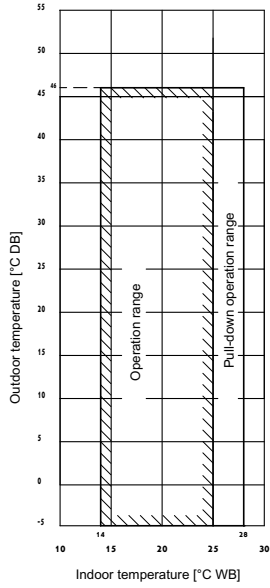

Heating

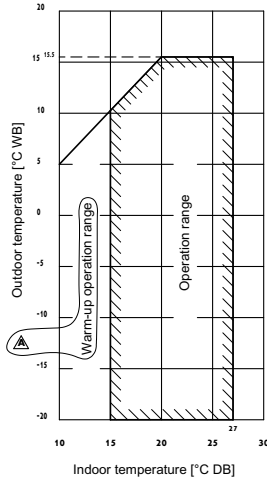

3D094664A



Daikin Europe N.V. Naamloze Vennootschap - Zandvoordestraat 300, B-8400 Oostende - Belgium - www.daikin.eu - BE 0412 120 336 - RPR Oostende

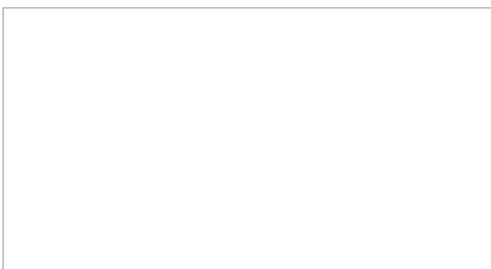

EEDEN17 06/17



Daikin Europe N.V. participates in the Eurovent Certification programme for Liquid Chilling Packages (LCP), Air handling units (AHU), Fan coil units (FCU) and variable refrigerant flow systems (VRF) Check ongoing validity of certificate online: www.eurovent-certification.com or using: www.certiflash.com



The present leaflet is drawn up by way of information only and does not constitute an offer binding upon Daikin Europe N.V.. Daikin Europe N.V. has compiled the content of this leaflet to the best of its knowledge. No express or implied warranty is given for the completeness, accuracy, reliability or fitness for particular purpose of its content and the products and services presented therein. Specifications are subject to change without prior notice. Daikin Europe N.V. explicitly rejects any liability for any direct or indirect damage, in the broadest sense, arising from or related to the use and/or interpretation of this leaflet. All content is copyrighted by Daikin Europe N.V.