

WINDOW SCHEDULE

1) Casement Windows 1860 x 1500 (2,79m²) **LGW 1.01 NEW**

Outside view

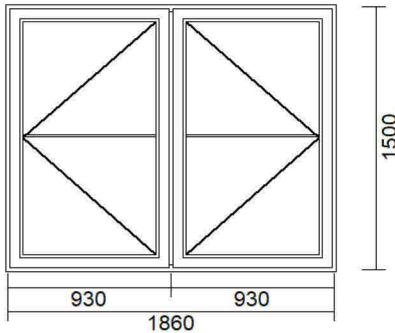

Quantity: 1 pcs

SYSTEM:	Casement Windows hard wood 1
TYP :	Casement Windows 1860 x 1500 (2,79m ²)
Glass 1	4-10+Ar-4LE U=1,1 W/m2K
Glass 2	4-10+Ar-4LE U=1,1 W/m2K
Colour	White RAL 9016
Delivery	London M25

TYPE A
variation 3

Accessories
Georgian Bars

2) Sash Windows weight 1300 x 1460 (1,90m²) **LGW 1.02, LGW 1.03**

Outside view

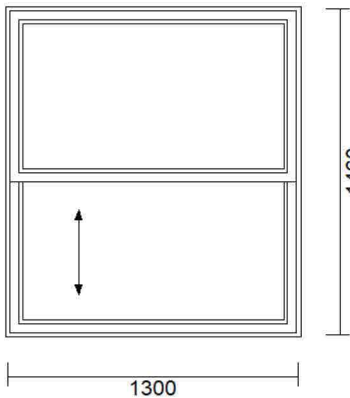

Quantity: 2 pcs

SYSTEM:	Sash Windows weight hard wood
TYP :	Sash Windows weight 1300 x 1460 (1,90m ²)
Top Glass	4-10+Ar-4LE U=1,1 W/m2K
Bottom Glass	4hart.-10+Ar-4LE hart. U=1,1 W/m2K (TG)
Colour	White RAL 9016
Delivery	London M25

TYPE D
variation 1

3) Sash Windows weight 1360 x 1750 (2,38m²) **LGW 1.04, LGW 1.05**

Outside view

Quantity: 2 pcs

SYSTEM:	Sash Windows weight hard wood
TYP :	Sash Windows weight 1360 x 1750 (2,38m ²)
Top Glass	4-10+Ar-4LE U=1,1 W/m2K
Bottom Glass	4hart.-10+Ar-4LE hart. U=1,1 W/m2K (TG)
Colour	White RAL 9016
Delivery	London M25

TYPE D

Accessories

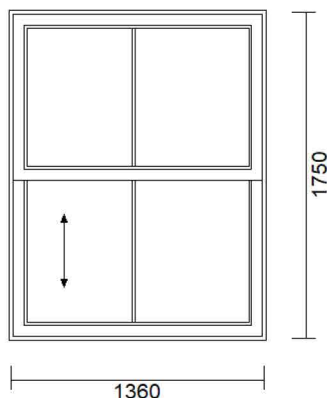

Georgian Bars

4) Sash Windows weight 890 x 1460 (1,30m²) **LGW 1A.01, LGW 1A.03**

Outside view

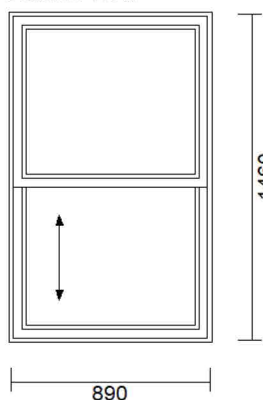

Quantity: 2 pcs

SYSTEM: Sash Windows weight hard wood
TYP : Sash Windows weight 890 x 1460 (1,30m²)
 Top Glass 4-10+Ar-4LE U=1,1 W/m²K
 Bottom Glass 4hart.-10+Ar-4LE hart. U=1,1 W/m²K (TG)
 Colour White RAL 9016
 Delivery London M25

TYPE D
variation 1

Accessories
Fix panel

5) French Doors 1370 x 2100 (2,88m²) **LGW 1A.02**

Outside view

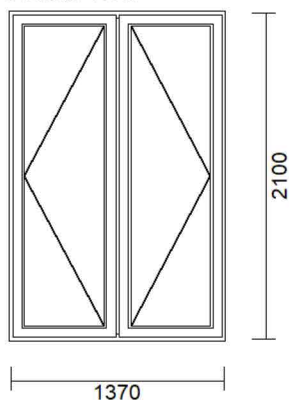

Quantity: 1 p cs

SYSTEM: French Doors hard wood
TYP : French Doors 1370 x 2100 (2,88m²)
 Glass 1 4hart.-10+Ar-4LE hart.(TG) slim lane
 Colour White RAL 9016
 Delivery London M25

TYPE B
variation 1

6) Sash Windows weight 1110 x 1460 (1,62m²) **LGW 1A.04**

Outside view

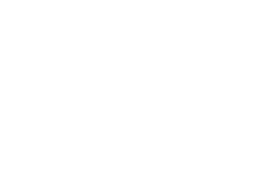

Quantity: 1 pcs

SYSTEM: Sash Windows weight hard wood
TYP : Sash Windows weight 1110 x 1460 (1,62m²)
 Top Glass 4-10+Ar-4LE (standard) slim lane
 Bottom Glass 4hart.-10+Ar-4LE hart.(TG) slim lane
 Colour White RAL 9016
 Delivery London M25

TYPE D

Accessories
Georgian Bars

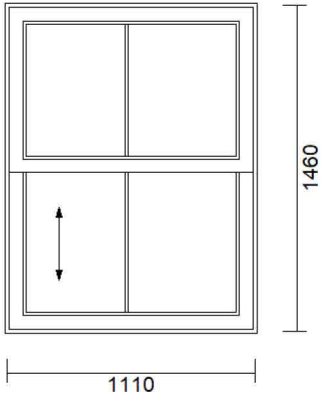

7) Casement Windows 480 x 1690 (0,81m²) GW C.01

Outside view

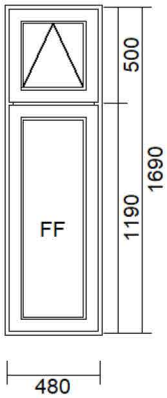

Quantity: 1 pcs

SYSTEM:

Casement Windows hard wood 1

TYPE A

TYP :

Casement Windows 480 x 1690 (0,81m²)

Glass 1

4-10+Ar-4LE U=1,1 W/m²K

Glass 2

4hart.-10+Ar-4LE hart.(TG) slim lane

Colour

White RAL 9016

Delivery

London M25

8) Casement Windows 580 x 1300 (0,75m²) LGW 13.02

Outside view

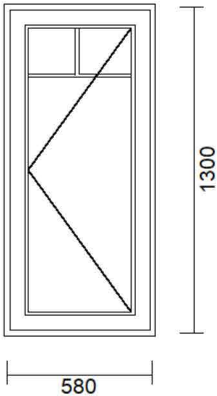

Quantity: 1 pcs

SYSTEM:

Casement Windows hard wood 1

TYPE A
variation 4

TYP :

Casement Windows 580 x 1300 (0,75m²)

Glass 1

4-10+Ar-4LE U=1,1 W/m²K

Glass 2

Not including

Colour

White RAL 9016

Delivery

London M25

Accessories

Georgian Bars

9) Casement Windows 580 x 1300 (0,75m²) LGW 13.02

Outside view

Quantity: 1 pcs

SYSTEM:

Casement Windows hard wood 1

TYPE A
variation 4

TYP :

Casement Windows 580 x 1300 (0,75m²)

Glass 1

4-10+Ar-4LE U=1,1 W/m²K

Glass 2

Not including

Colour

White RAL 9016

Delivery

London M25

Accessories

Georgian Bars

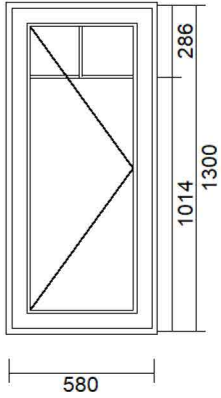

10) French Doors 1520 x 2150 (3,27m²) LGW 13.02

Outside view

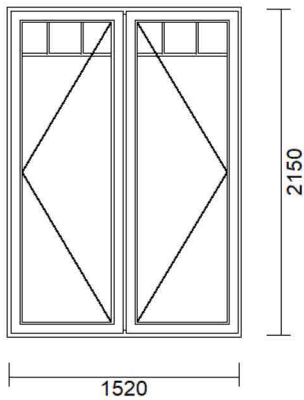

Quantity: 1 pcs

SYSTEM: French Doors hard wood
TYP : French Doors 1520 x 2150 (3,27m²)
 Glass 1 4hart.-10+Ar-4LE hart.(TG) slim lane
 Colour White RAL 9016
 Delivery London M25

TYPE E
variation 1

Accessories
Georgian Bars

11) Casement Windows 1700 x 1280 (2,18m²) LGW 13.03 GW 14.03

Outside view

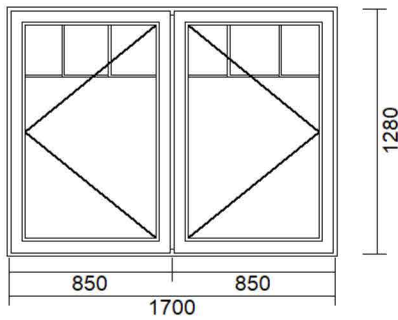

Quantity: 2 pcs

SYSTEM: Casement Windows hard wood 1
TYP : Casement Windows 1700 x 1280 (2,18m²)
 Glass 1 4-10+Ar-4LE U=1,1 W/m2K
 Glass 2 4-10+Ar-4LE U=1,1 W/m2K
 Colour White RAL 9016
 Delivery London M25

TYPE A
variation 4

Accessories
Georgian Bars

12) Casement Windows 850 x 1280 (1,09m²) LGW 13.04, GW 14.04

Quantity: 2 pcs

SYSTEM: Casement Windows hard wood 1
TYP : Casement Windows 850 x 1280 (1,09m²)
 Glass 1 4-10+Ar-4LE U=1,1 W/m2K
 Glass 2 4-10+Ar-4LE U=1,1 W/m2K
 Colour White RAL 9016
 Delivery London M25

TYPE A
variation 4

Accessories

Georgian Bars

13) Casement Windows 840 x 470 (0,39m²) LGW 13.05

Outside view

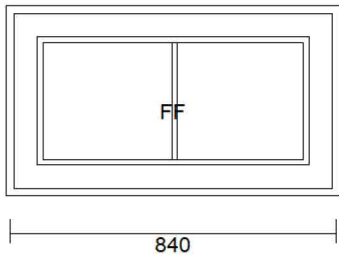

Quantity: 1 pcs

SYSTEM:

Casement Windows hard wood 1

TYP :

Casement Windows 840 x 470 (0,39m²)

Glass 1

4 matowe-10-Ar-4LE U=1,1 W/m2K (OB - Frosted)

Glass 2

Not including

Colour

White RAL 9016

Delivery

London M25

Accessories

Georgian Bars

14) Sash Windows weight 1000 x 1050 (1,05m²) 1W5.01, 1W6.01, 1W5.07, 1W6.05, 2W9.02, 3W12.02 / GW14.05, GW14.06

Outside view

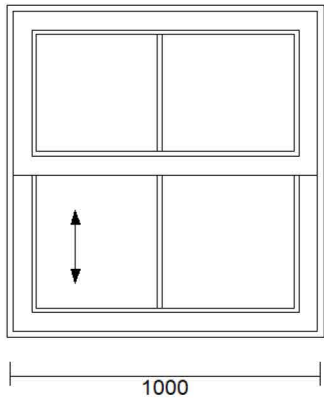

Quantity: 8 pcs

SYSTEM:

Sash Windows weight hard wood

TYPE D

TYP :

Sash Windows weight 1000 x 1050 (1,05m²)

Top Glass

4-10+Ar-4LE U=1,1 W/m2K

Bottom Glass

4hart.-10+Ar-4LE hart. U=1,1 W/m2K (TG)

Colour

White RAL 9016

Delivery

London M25

Accessories

Georgian Bars

15) Casement Windows 550 x 2460 (1,35m²) EX. GW2.01

Outside view

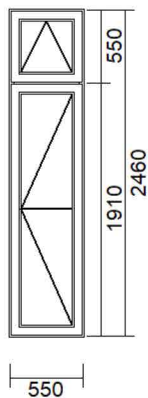

Quantity: 1 pcs

SYSTEM:

Casement Windows hard wood 1

TYPE A

TYP :

Casement Windows 550 x 2460 (1,35m²)

Glass 1

4-10+Ar-4LE U=1,1 W/m2K

Glass 2

4hart.-10+Ar-4LE hart.(TG) slim lane

Colour

White RAL 9016

Delivery

London M25

Accessories

Georgian Bars

16) Casement Windows 550 x 2460 (1,35m²) EX. GW2.03

Outside view

Quantity: 1 pcs

SYSTEM:

Casement Windows hard wood 1

TYPE A

TYP :

Casement Windows 550 x 2460 (1,35m²)

Glass 1

4-10+Ar-4LE U=1,1 W/m2K

Glass 2

4hart.-10+Ar-4LE hart.(TG) slim lane

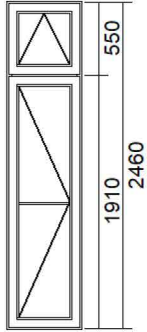

Colour White RAL 9016
Delivery London M25

Accessories
Georgian Bars

17) Casement Windows 1860 x 2460 (4,58m²) EX. GW2.02

Outside view

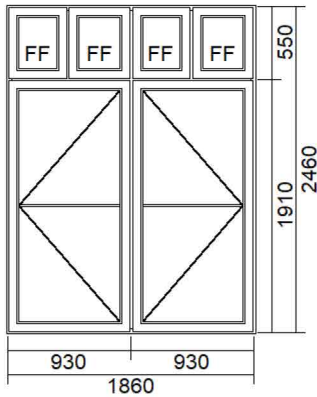

Quantity: 1 pcs

SYSTEM: Casement Windows hard wood 1
TYP : Casement Windows 1860 x 2460 (4,58m²)
Glass 1 4-10+Ar-4LE U=1,1 W/m2K
Glass 2 4hart.-10+Ar-4LE hart.(TG) slim lane
Colour White RAL 9016
Delivery London M25

TYPE A
variation 1

Accessories
Georgian Bars

18) Arched Sash weight 1160 x 2500 (2,90m²) EX. GW2.04, GW2.05

Outside view

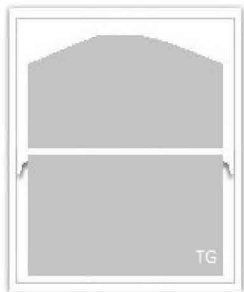

2500

Quantity : 2 pcs

SYSTEM: Sash Windows weight hard wood
TYP : Arched Sash weight 1160 x 2500 (2,90m²)
Top Glass 4-10+Ar-4LE U=1,1 W/m2K
Bottom Glass 4hart.-10+Ar-4LE hart. U=1,1 W/m2K (TG)
Colour White RAL 9016
Delivery London M25

TYPE F

Accessories
Arch Windows

1160

19) Casement Windows 730 x 3180 (2,32m²) EX. GW 3.01, GW 3.03

Outside view

Quantity : 2 pcs

SYSTEM: Casement Windows hard wood 1
TYP : Casement Windows 730 x 3180 (2,32m²)
Glass 1 4hart.-10+Ar-4LE hart.(TG) slim lane
Glass 2 Not including
Colour White RAL 9016
Delivery London M25

TYPE A

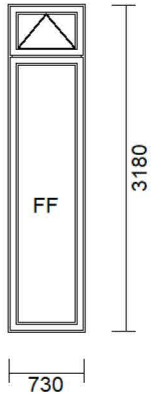

20) French Doors 1370 x 3180 (4,36m²) EX. GW 3.02

Outside view

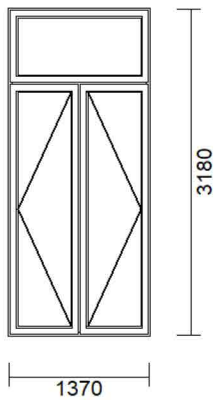

Quantity: 1 pcs

SYSTEM: French Doors hard wood
TYP : French Doors 1370 x 3180 (4,36m²)
 Glass 1 4hart.-10+Ar-4LE hart.(TG) slim lane
 Colour White RAL 9016
 Delivery London M25

TYPE B

21) Sash Windows weight 1110 x 2430 (2,70m²) NEW GW 3.04

Outside view

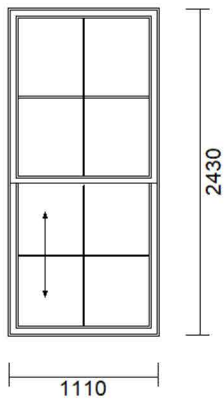

Quantity: 1 pcs

SYSTEM: Sash Windows weight hard wood
TYP : Sash Windows weight 1110 x 2430 (2,70m²)
 Top Glass 4hart.-10+Ar-4LE hart. U=1,1 W/m2K (TG)
 Bottom Glass 4hart.-10+Ar-4LE hart. U=1,1 W/m2K (TG)
 Colour White RAL 9016
 Delivery London M25

TYPE D
variation 2

Accessories
Georgian Bars

22) Sash Windows weight 1000 x 1310 (1,31m²) NEW GWC.02, GW3.07, 1W7.01, 1W4.06, 1W4.01, 2W8.01, 2W11.04

Outside view

Quantity : 7 pcs

SYSTEM: Sash Windows weight hard wood
TYP : Sash Windows weight 1000 x 1310 (1,31m²)
 Top Glass 4-10+Ar-4LE U=1,1 W/m2K
 Bottom Glass 4hart.-10+Ar-4LE hart. U=1,1 W/m2K (TG)
 Colour White RAL 9016
 Delivery London M25

TYPE D

Accessories

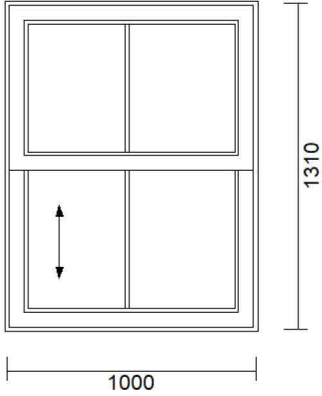

Georgian Bars

23) Casement Windows 1700 x 1280 (2,18m²)

GW 14.01

Outside view

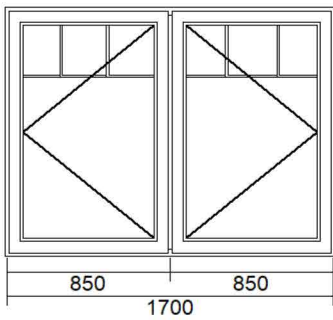

Quantity: 1 pcs

SYSTEM: Casement Windows hard wood 1
TYP : Casement Windows 1700 x 1280 (2,18m²)
 Glass 1 4-10+Ar-4LE U=1,1 W/m2K
 Glass 2 Not including
 Colour White RAL 9016
 Delivery London M25

TYPE A
variation 4

Accessories
Georgian Bars

24) French Doors 2520 x 2270 (5,72m²)

GW 14.02

Outside view

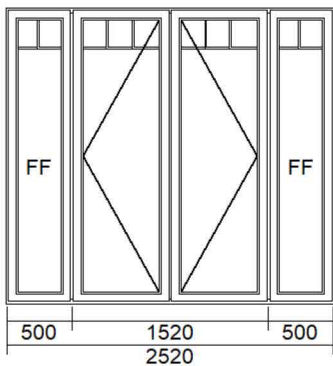

Quantity; 1 pcs

SYSTEM: French Doors hard wood
TYP : French Doors 2520 x 2270 (5,72m²)
 Glass 1 4hart.-10+Ar-4LE hart.(TG) slim lane
 Colour White RAL 9016
 Delivery London M25

TYPE E

Accessories
Georgian Bars

25) Casement Windows 480 x 1420 (0,68m²)

1W4.04, 1W4.05, 2W8.02, 2W8.03, 3W12.03

Outside view

Quantity: 5 pcs

SYSTEM: Casement Windows hard wood 1
TYP : Casement Windows 480 x 1420 (0,68m²)
 Glass 1 4-10+Ar-4LE U=1,1 W/m2K
 Glass 2 4-10+Ar-4LE U=1,1 W/m2K
 Colour White RAL 9016
 Delivery London M25

TYPE A

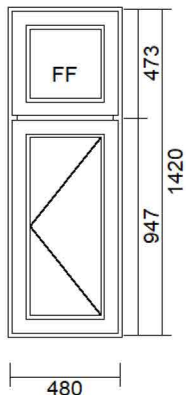

26) Casement Windows 920 x 2160 (1,99m²) EX 1W4.02, 1W4.03

Outside view

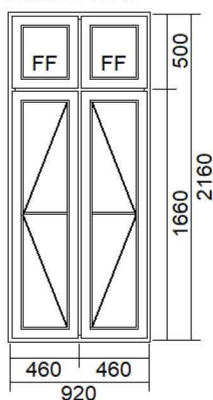

Quantity: 2 pcs

SYSTEM: Casement Windows hard wood 1
TYP : Casement Windows 920 x 2160 (1,99m²)
 Glass 1 4-10+Ar-4LE U=1,1 W/m2K
 Glass 2 4hart.-10+Ar-4LE hart.(TG) slim lane
 Colour White RAL 9016
 Delivery London M25

TYPE A
variation 1

Accessories
Georgian Bars

27) Casement Windows 550 x 2160 (1,19m²) EX 1W5.06

Outside view

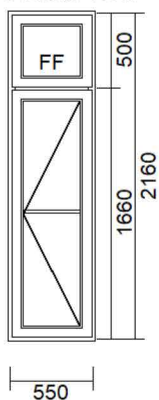

Quantity: 1 pcs

SYSTEM: Casement Windows hard wood 1
TYP : Casement Windows 550 x 2160 (1,19m²)
 Glass 1 4-10+Ar-4LE U=1,1 W/m2K
 Glass 2 4hart.-10+Ar-4LE hart.(TG) slim lane
 Colour White RAL 9016
 Delivery London M25

TYPE A

Accessories
Georgian Bars

28) Casement Windows 550 x 2160 (1,19m²) EX 1W5.02

Outside view

Quantity: 1 pcs

SYSTEM: Casement Windows hard wood 1
TYP : Casement Windows 550 x 2160 (1,19m²)
 Glass 1 4-10+Ar-4LE U=1,1 W/m2K
 Glass 2 4hart.-10+Ar-4LE hart.(TG) slim lane
 Colour White RAL 9016
 Delivery London M25

TYPE A

Accessories

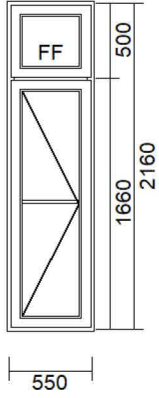

Georgian Bars

29) Casement Windows 550 x 2160 (1,19m²) EX 1W5.03

Outside view

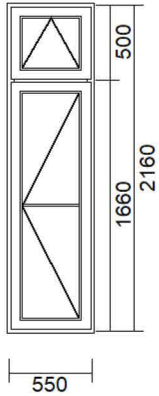

Quantity : 1 pcs

SYSTEM: Casement Windows hard wood 1
TYP : Casement Windows 550 x 2160 (1,19m²)
 Glass 1 4-10+Ar-4LE U=1,1 W/m2K
 Glass 2 4hart.-10+Ar-4LE hart.(TG) slim lane
 Colour White RAL 9016
 Delivery London M25

TYPE A

Accessories
 Georgian Bars

30) Casement Windows 550 x 2160 (1,19m²) EX 1W5.05

Outside view

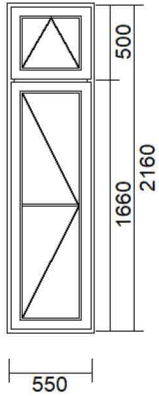

Quantity: 1 pcs

SYSTEM: Casement Windows hard wood 1
TYP : Casement Windows 550 x 2160 (1,19m²)
 Glass 1 4-10+Ar-4LE U=1,1 W/m2K
 Glass 2 4hart.-10+Ar-4LE hart.(TG) slim lane
 Colour White RAL 9016
 Delivery London M25

TYPE A

Accessories
 Georgian Bars

31) Casement Windows 1860 x 2160 (4,02m²) EX 1W5.04

Outside view

Quantity: 1 pcs

SYSTEM: Casement Windows hard wood 1
TYP : Casement Windows 1860 x 2160 (4,02m²)
 Glass 1 4-10+Ar-4LE U=1,1 W/m2K
 Glass 2 4hart.-10+Ar-4LE hart.(TG) slim lane
 Colour White RAL 9016
 Delivery London M25

TYPE A
 variation 1

Accessories

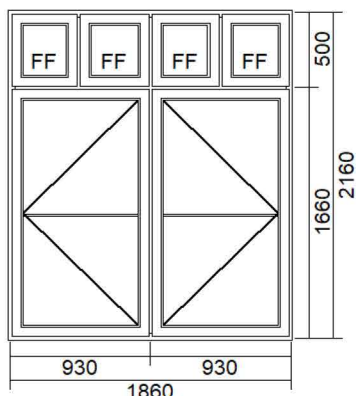

Georgian Bars

32) Sash Windows weight 730 x 2220 (1,62m²) EX 1W6.02, 1W6.04

Outside view

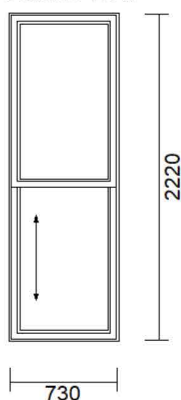

Quantity: 2 pcs

SYSTEM: Sash Windows weight hard wood
TYP : Sash Windows weight 730 x 2220 (1,62m²)
 Top Glass 4-10+Ar-4LE U=1,1 W/m²K
 Bottom Glass 4hart.-10+Ar-4LE hart. U=1,1 W/m²K (TG)
 Colour White RAL 9016
 Delivery London M25

TYPE D
variation 1

33) Sash Windows weight 1500 x 2220 (3,33m²) EX 1W6.03

Outside view

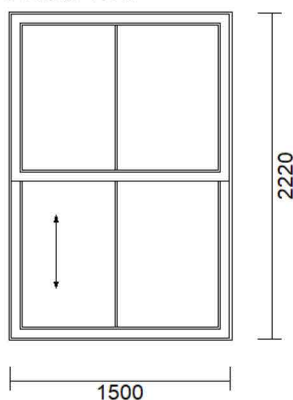

Quantity: 1 pcs

SYSTEM: Sash Windows weight hard wood
TYP : Sash Windows weight 1500 x 2220 (3,33m²)
 Top Glass 4-10+Ar-4LE U=1,1 W/m²K
 Bottom Glass 4hart.-10+Ar-4LE hart. U=1,1 W/m²K (TG)
 Colour White RAL 9016
 Delivery London M25

TYPE D

Accessories
Georgian Bars

34) Sash Windows weight 1070 x 2220 (2,38m²) EX 1W7.03, 1W7.04

Outside view

Quantity: 2 pcs

SYSTEM: Sash Windows weight hard wood
TYP : Sash Windows weight 1070 x 2220 (2,38m²)
 Top Glass 4-10+Ar-4LE U=1,1 W/m²K
 Bottom Glass 4hart.-10+Ar-4LE hart. U=1,1 W/m²K (TG)
 Colour White RAL 9016
 Delivery London M25

TYPE D

Accessories

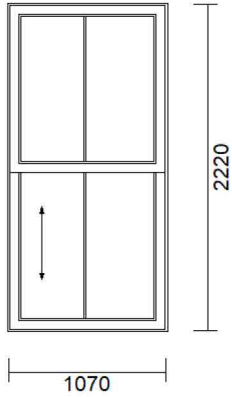

Georgian Bars

35) Casement Windows 1250 x 2250 (2,81m²) EX 2W8.04

Outside view

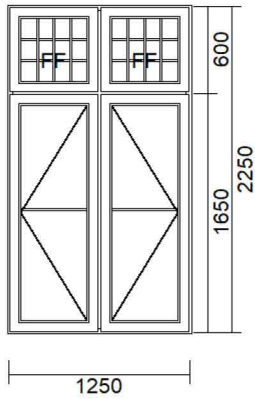

Quantity: 1 pcs

SYSTEM: Casement Windows hard wood 1
TYP : Casement Windows 1250 x 2250 (2,81m²)

TYPE A
variation 1

Glass 1 Square Lead
Glass 2 4 matowe-10-Ar-4LE U=1,1 W/m2K (OB - Frosted)
Colour White RAL 9016
Delivery London M25

Accessories

Georgian Bars

36) Casement Windows 950 x 2050 (1,95m²) EX 2W9.01

Outside view

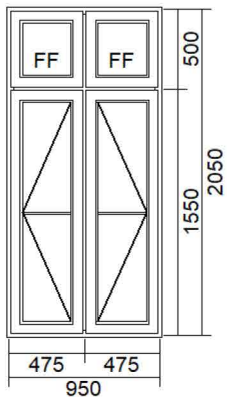

Quantity: 1 pcs

SYSTEM: Casement Windows hard wood 1
TYP : Casement Windows 950 x 2050 (1,95m²)

TYPE A
variation 1

Glass 1 4-10+Ar-4LE U=1,1 W/m2K
Glass 2 4hart.-10+Ar-4LE hart.(TG) slim lane
Colour White RAL 9016
Delivery London M25

Accessories

Georgian Bars

37) Sash with Arch weight 920 x 3040 (2,80m²) EX 2W10.01, 2W11.02

Outside view

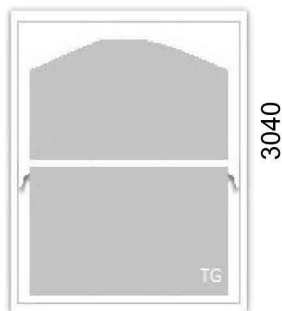

920

Quantity: 2 pcs

SYSTEM: Sash Windows weight hard wood
TYP : Sash with Arch weight 920 x 3040 (2,80m²)
 Top Glass 4hart.-10+Ar-4LE hart. U=1,1 W/m²K (TG)
 Bottom Glass 4hart.-10+Ar-4LE hart. U=1,1 W/m²K (TG)
 Colour White RAL 9016
 Delivery London M25

TYPE F

Accessories
Arch Windows

38) Double Sash Windows weight 1730 x 3050 (5,28m²) EX 2W10.02, 2W11.01

Outside view

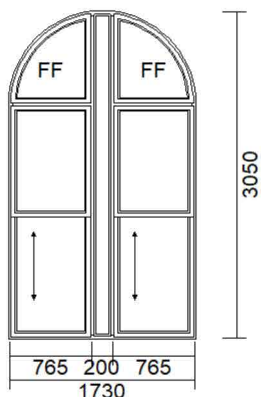

Quantity: 1 pcs

SYSTEM: Sash Windows weight hard wood
TYP : Double Sash Windows weight 1730 x 3050 (5,28m²)
 Top Glass 4hart.-10+Ar-4LE hart. U=1,1 W/m²K (TG)
 Bottom Glass 4hart.-10+Ar-4LE hart. U=1,1 W/m²K (TG)
 Colour White RAL 9016
 Delivery London M25

TYPE C

Accessories
Arch Windows

39) Casement Windows 1250 x 1210 (1,51m²) EX 2W11.03

Outside view

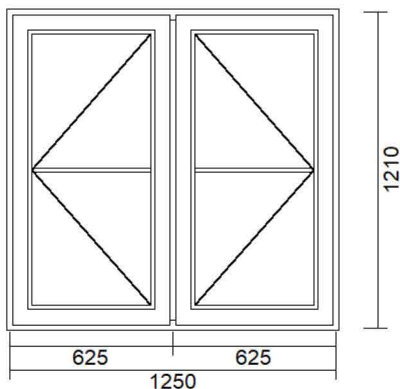

Quantity: 1 pcs

SYSTEM: Casement Windows hard wood 1
TYP : Casement Windows 1250 x 1210 (1,51m²)
 Glass 1 4-10+Ar-4LE U=1,1 W/m²K
 Glass 2 4-10+Ar-4LE U=1,1 W/m²K
 Colour White RAL 9016
 Delivery London M25

TYPE A
variation 3

Accessories
Georgian Bars

40) Casement Windows 1250 x 930 (1,16m²) 1W7.05 NEW

Outside view

Quantity: 1 pcs

SYSTEM: Casement Windows hard wood 1
TYP : Casement Windows 1250 x 930 (1,16m²)
 Glass 1 4-10+Ar-4LE U=1,1 W/m²K
 Glass 2 4-10+Ar-4LE U=1,1 W/m²K
 Colour White RAL 9016
 Delivery London M25

TYPE A
variation 3

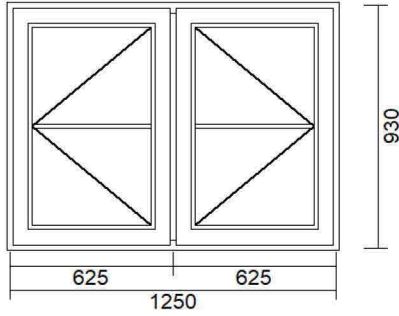

Accessories
Georgian Bars

41) Casement Windows 900 x 1000 (0,90m²) **NEW 3W12.01**

Outside view

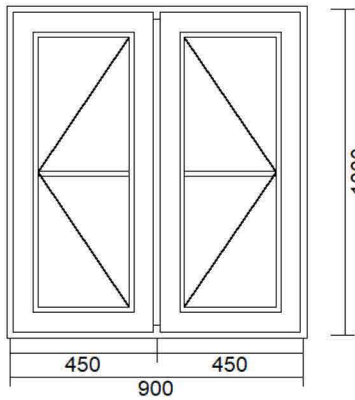

Quantity: 1 pcs

SYSTEM: Casement Windows hard wood 1
TYP : Casement Windows 900 x 1000 (0,90m²)
Glass 1 4-10+Ar-4LE U=1,1 W/m²K
Glass 2 4-10+Ar-4LE U=1,1 W/m²K
Colour White RAL 9016
Delivery London M25

TYPE A
variation 3

Accessories
Georgian Bars

42) Casement Windows 350 x 920 (0,32m²) **NEW 3W12.06**

Outside view

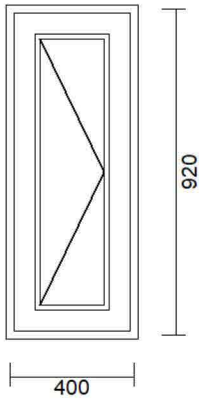

Quantity: 1 pcs

SYSTEM: Casement Windows hard wood 1
TYP : Casement Windows 350 x 920 (0,32m²)
Glass 1 4-10+Ar-4LE U=1,1 W/m²K
Glass 2 Not including
Colour White RAL 9016
Delivery London M25

TYPE A
variation 2

43) Casement Windows 350 x 920 (0,32m²) **NEW 3W12.05**

Outside view

Quantity: 1 pcs

SYSTEM: Casement Windows hard wood 1
TYP : Casement Windows 350 x 920 (0,32m²)
Glass 1 4-10+Ar-4LE U=1,1 W/m²K
Glass 2 Not including
Colour White RAL 9016
Delivery London M25

TYPE A
variation 2

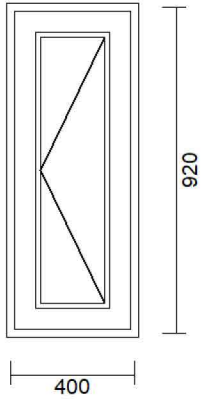

44) Casement Windows 480 x 1000 (0,48m²) NEW GW14.07

Outside view

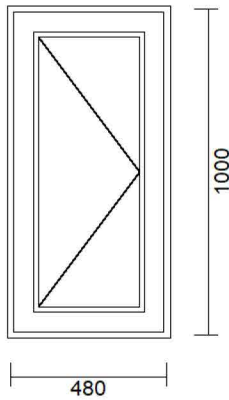

Quantity: 1 pcs

SYSTEM:	Casement Windows hard wood 1	TYPE A variation 2
TYP :	Casement Windows 480 x 1000 (0,48m ²)	
Glass 1	4-10+Ar-4LE U=1,1 W/m2K	
Glass 2	Not including	
Colour	White RAL 9016	
Delivery	London M25	

45) Casement Windows 480 x 1000 (0,48m²) NEW LG13.01, GW3.05, GW3.06, 1W7.02

Outside view

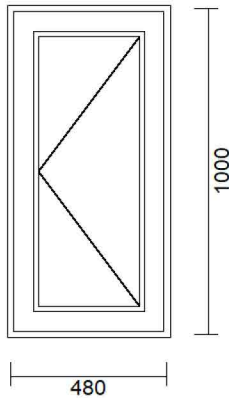

Quantity: 4 pcs

SYSTEM:	Casement Windows hard wood 1	TYPE A variation 2
TYP :	Casement Windows 480 x 1000 (0,48m ²)	
Glass 1	4 matowe-10-Ar-4LE U=1,1 W/m2K (OB - Frosted)	
Glass 2	Not including	
Colour	White RAL 9016	
Delivery	London M25	