

Do not scale from this drawing.  
 Dimensions are to be verified on site prior to  
 construction.  
 Notes

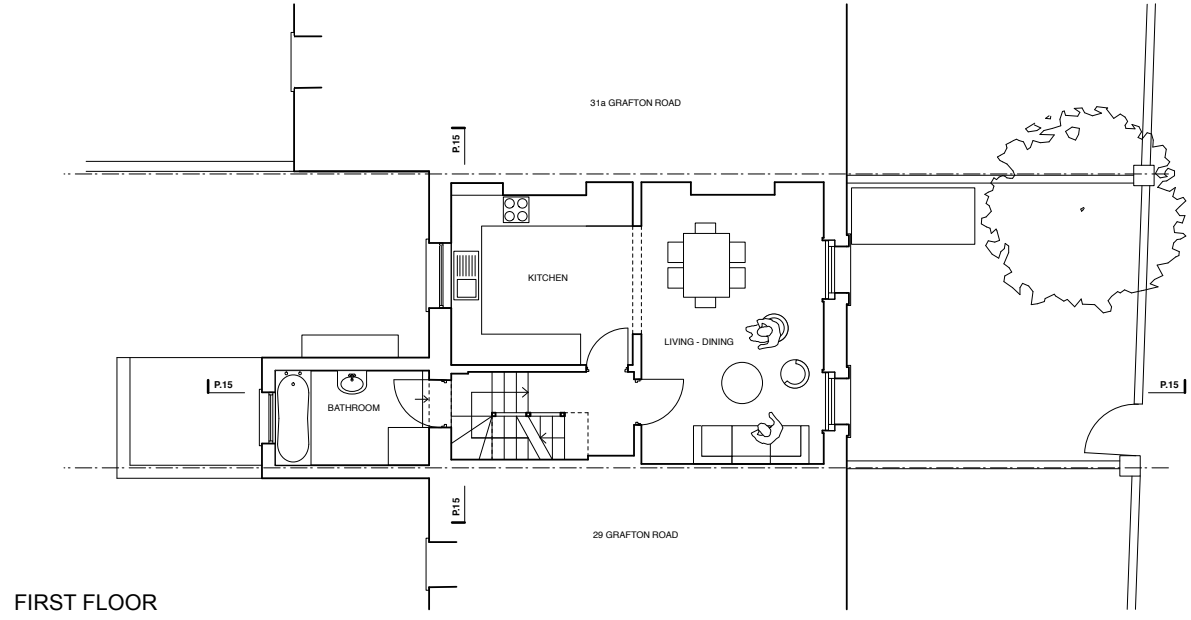

FIRST FLOOR

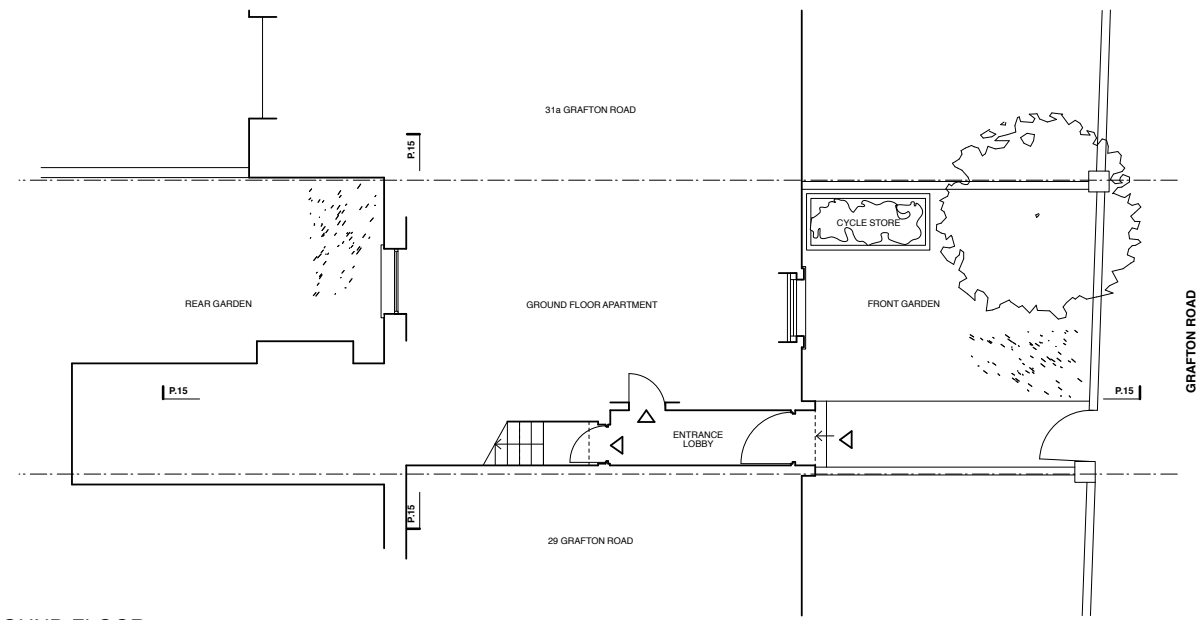

GROUND FLOOR



**Revisions**  
**A** Amendments following  
 Planning Officer comments 18.06.26

# 4orm

1-5 Offord Street London N1 1DH  
 studio@4orm.co.uk  
 www.4orm.co.uk

Project  
**31 Grafton Road**  
 London NW5 3DX

Drawing Title  
**Proposed Ground and First  
 Floor Plan**

Drawing Status  
**PLANNING**

Date	Scale @ A3	Drawn
Apr 2018	1:100	LCR

Drawing Number  
**4099-P.03\_A**

Do not scale from this drawing.  
 Dimensions are to be verified on site prior to  
 construction.  
 Notes

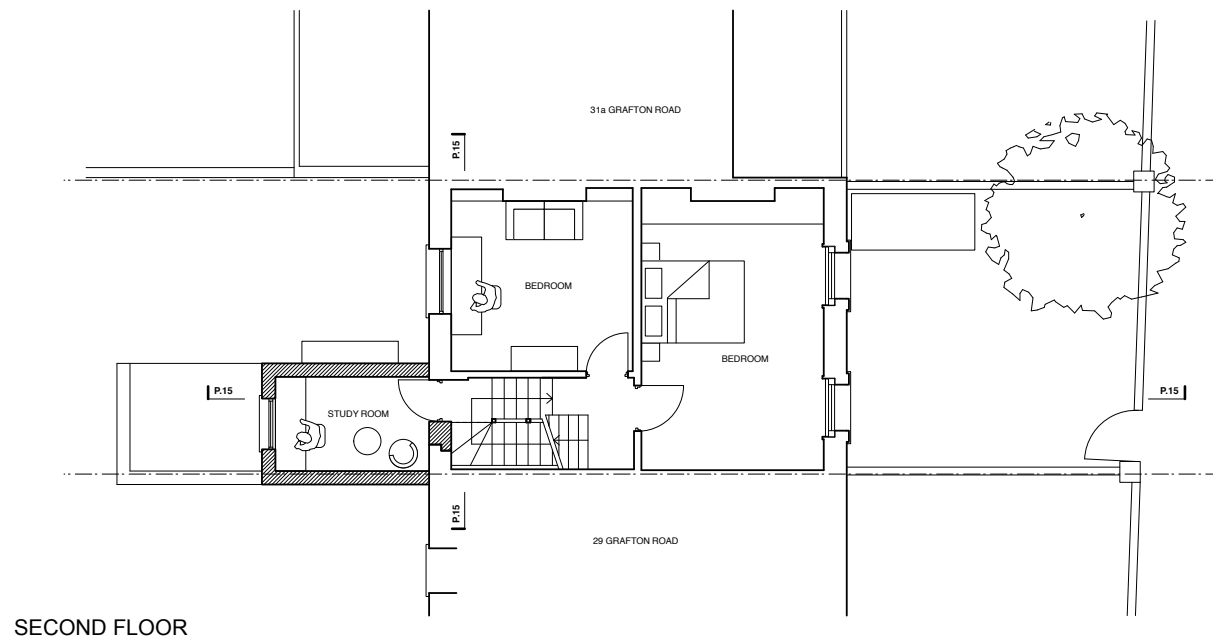
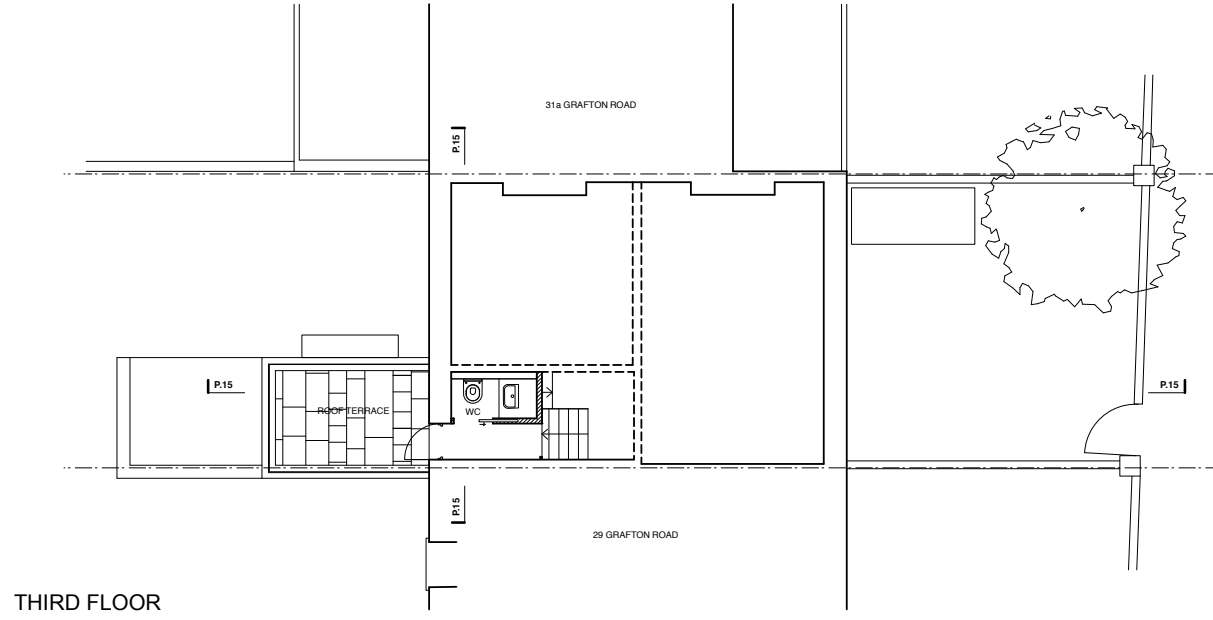

Revisions  
**A** Amendments following  
 Planning Officer comments 18.06.26

**4orm**

1-5 Offord Street London N1 1DH  
 studio@4orm.co.uk  
 www.4orm.co.uk

Project  
**31 Grafton Road**  
 London NW5 3DX

Drawing Title  
**Proposed Second and Third  
 Floor Plan**

Drawing Status  
**PLANNING**

Date	Scale @ A3	Drawn
Apr 2018	1:100	LCR

Drawing Number  
**4099-P.04\_A**

Do not scale from this drawing.  
Dimensions are to be verified on site prior to  
construction.  
Notes

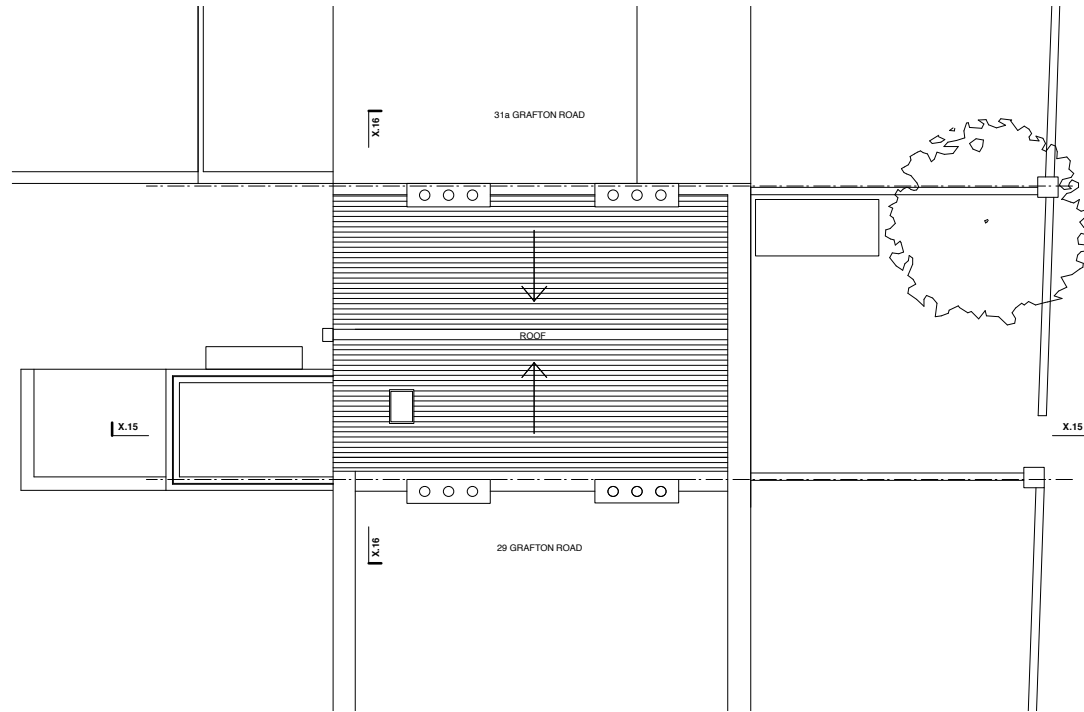

ROOF PLAN

**Revisions**  
A Amendments following  
Planning Officer comments 18.06.26

**4orm**

1-5 Offord Street London N1 1DH

studio@4orm.co.uk  
www.4orm.co.uk

Project  
31 Grafton Road  
London NW5 3DX

Drawing Title  
Proposed Roof  
Plan

Drawing Status  
PLANNING

Date	Scale @ A3	Drawn
Apr 2018	1:100	LCR

Drawing Number

4099-P.05\_A





FRONT ELEVATION

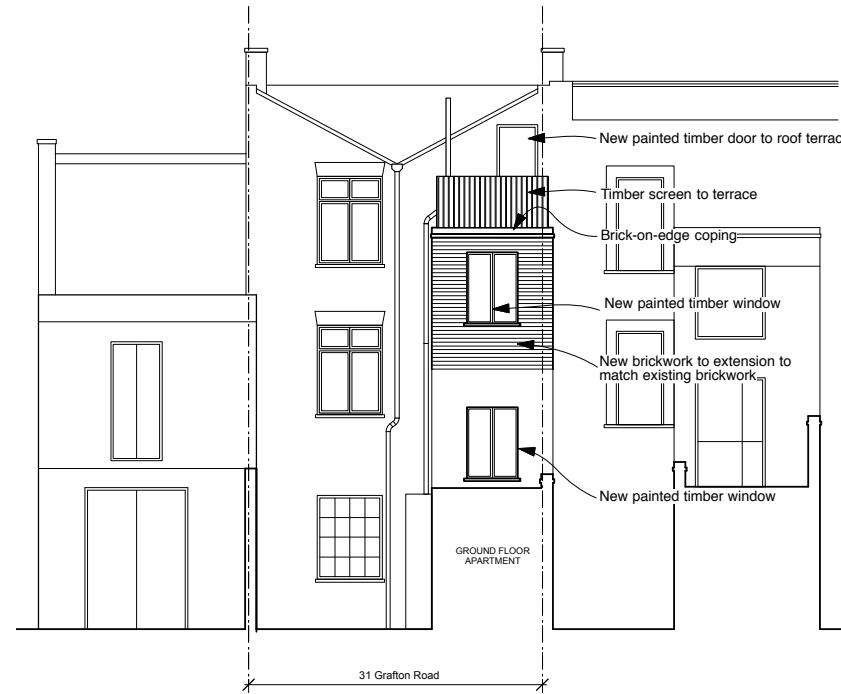

REAR ELEVATION



Revisions  
A Amendments following Planning Officer comments 18.06.26

**4orm**

1-5 Offord Street London N1 1DH

studio@4orm.co.uk  
www.4orm.co.uk

Project  
31 Grafton Road  
London NW5 3DX

Drawing Title  
Proposed Front and Back  
Elevation

Drawing Status  
PLANNING

Date	Scale @ A3	Drawn
Apr 2018	1:100	LCR

Drawing Number

4099-P.10\_A

Do not scale from this drawing.  
 Dimensions are to be verified on site prior to  
 construction.  
 Notes

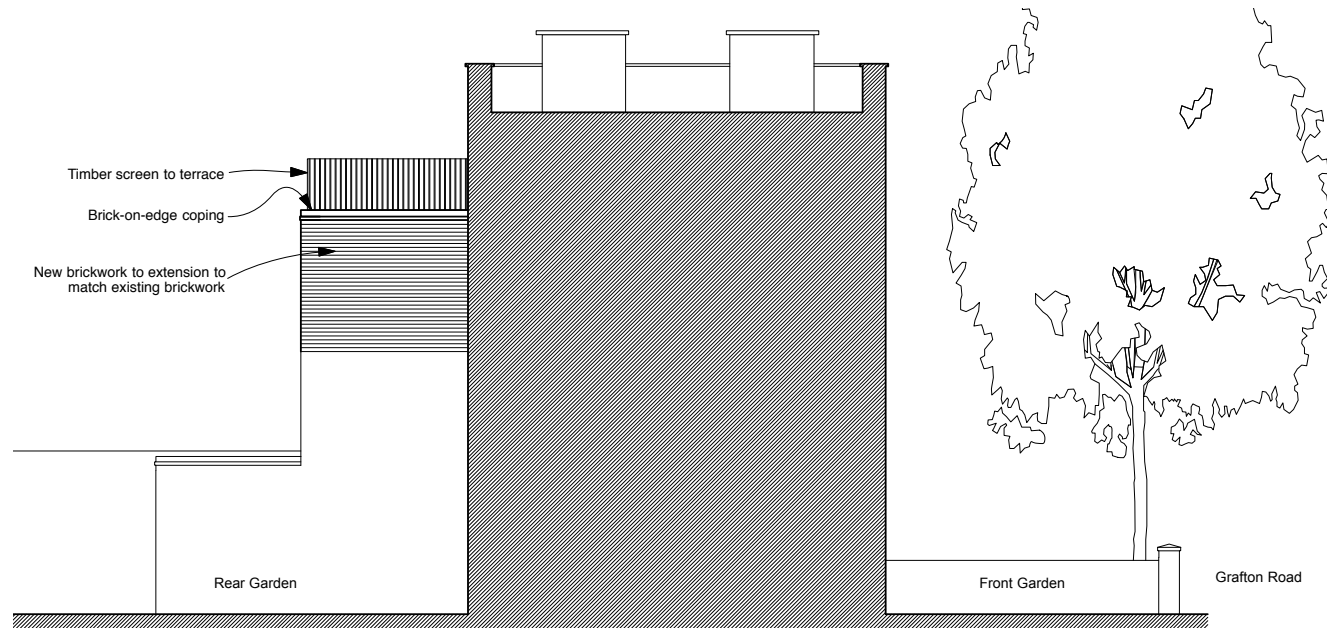

SIDE ELEVATION FROM 29 GRAFTON ROAD

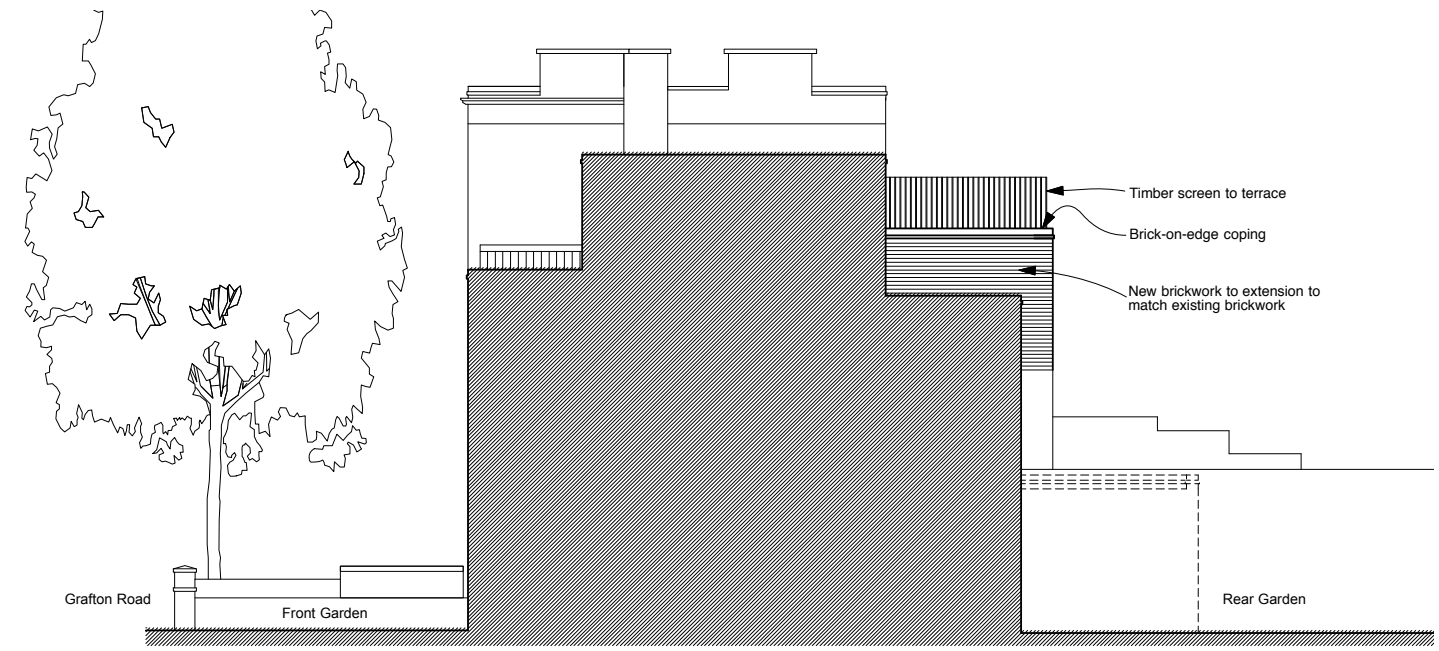

SIDE ELEVATION FROM 31a GRAFTON ROAD



Revisions

**4orm**

1-5 Offord Street London N1 1DH  
 studio@4orm.co.uk  
 www.4orm.co.uk

Project  
**31 Grafton Road**  
 London NW5 3DX

Drawing Title  
**Proposed Side Elevations**

Drawing Status  
**PLANNING**

Date	Scale @ A3	Drawn
Apr 2018	1:100	LCR

Drawing Number

**4099-P.11**

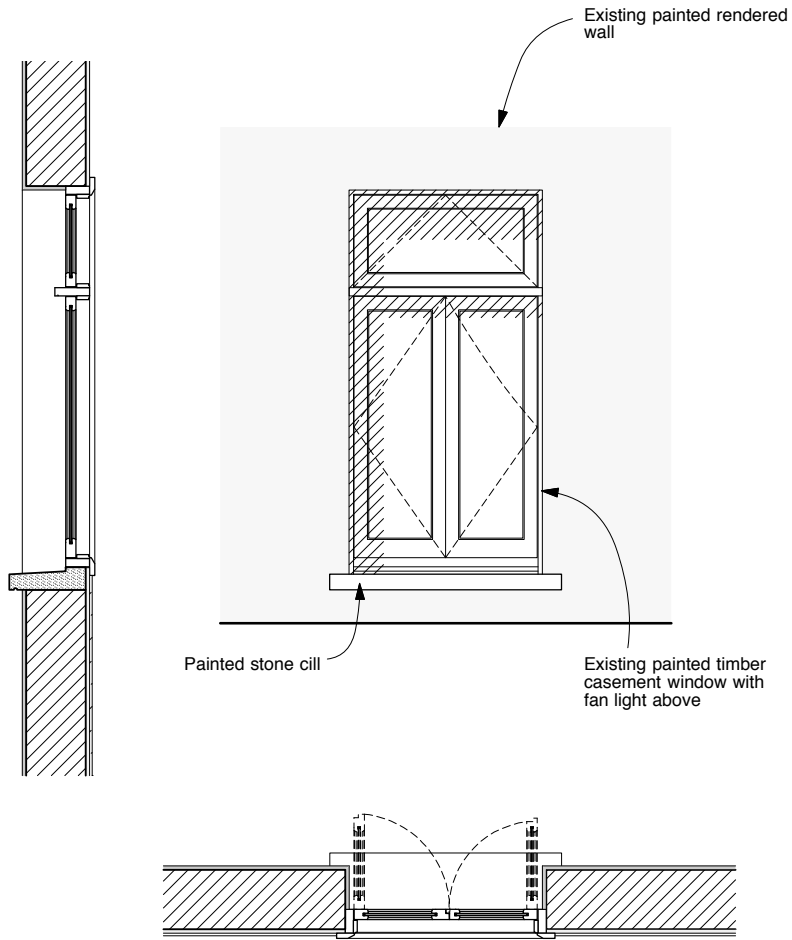

EXISTING REAR WINDOW DETAILS - 1.20 SCALE

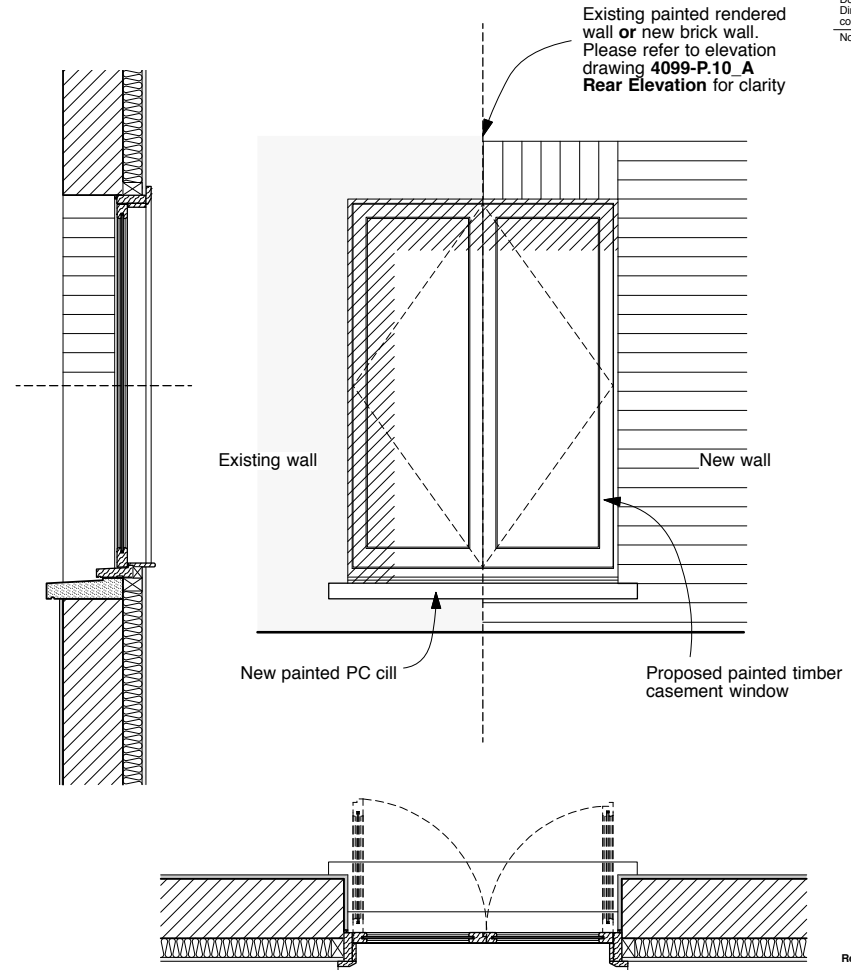

PROPOSED REAR WINDOW DETAILS - 1.20 SCALE

Do not scale from this drawing. Dimensions are to be verified on site prior to construction.  
Notes

Revisions

**4orm**

1-5 Offord Street London N1 1DH

studio@4orm.co.uk  
www.4orm.co.uk

Project  
31 Grafton Road  
London NW5 3DX

Drawing Title  
Existing & Proposed Rear  
Window Details

Drawing Status  
PLANNING

Date	Scale @ A3	Drawn
Apr 2018	1:20	JW

Drawing Number

4099-P.12

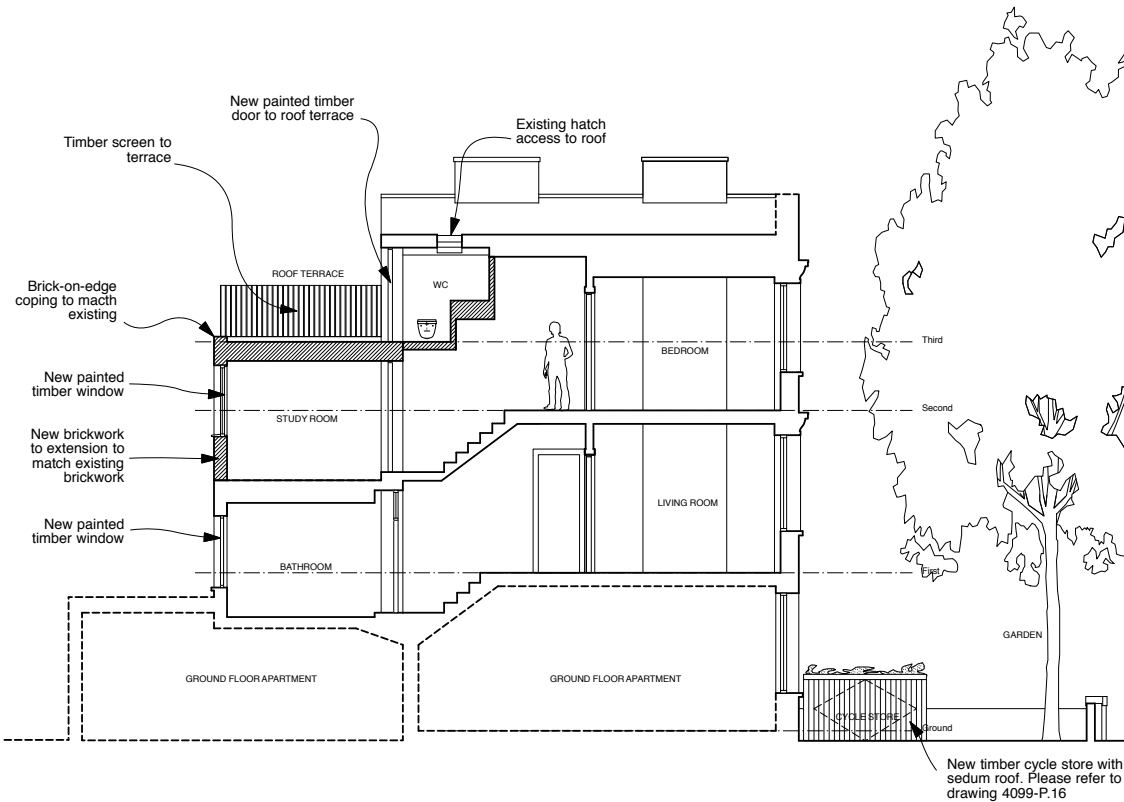

LONG SECTION

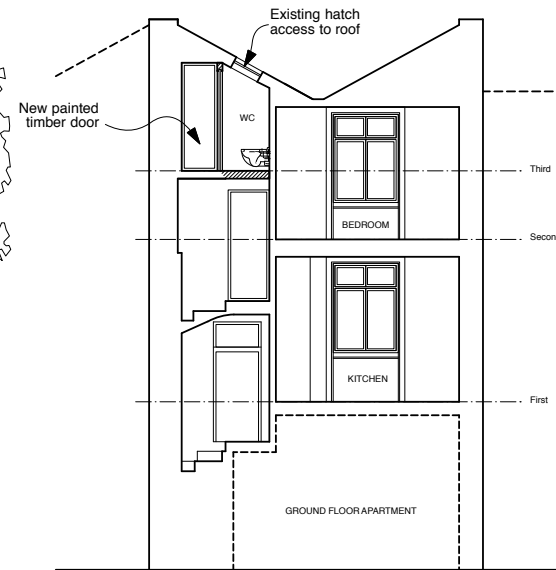

SHORT SECTION

Revisions  
**A** Amendments following Planning Officer comments 18.06.26

**4orm**

1-5 Offord Street London N1 1DH  
 studio@4orm.co.uk  
 www.4orm.co.uk

Project  
**31 Grafton Road  
 London NW5 3DX**

Drawing Title  
**Proposed  
 Sections**

Drawing Status  
**PLANNING**

Date: Apr 2018 Scale @ A3: 1:100 Drawn: LCR

Drawing Number  
**4099-P.15\_A**



Do not scale from this drawing.  
 Dimensions are to be verified on site prior to  
 construction.  
 Notes

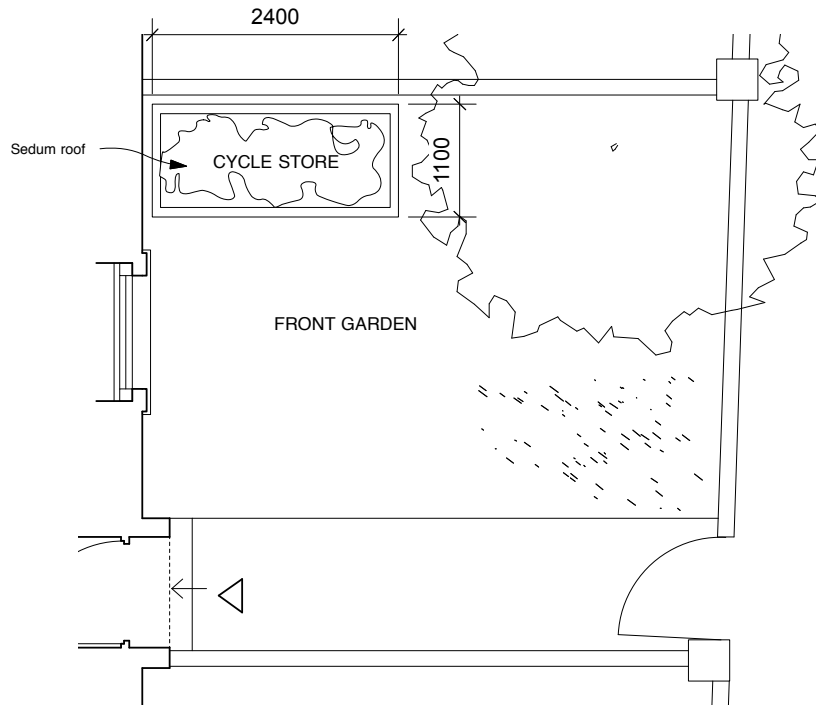

FRONT GARDEN PLAN

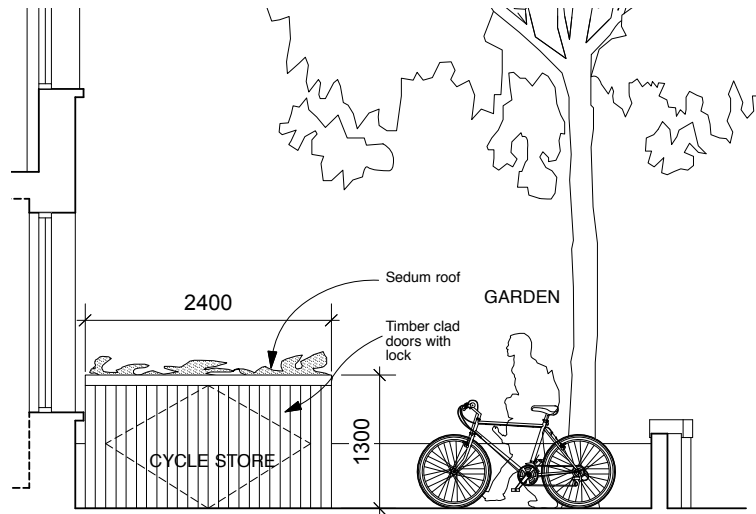

FRONT GARDEN SECTION



FRONT ELEVATION

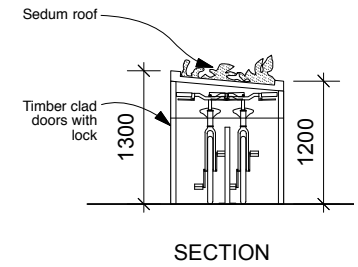
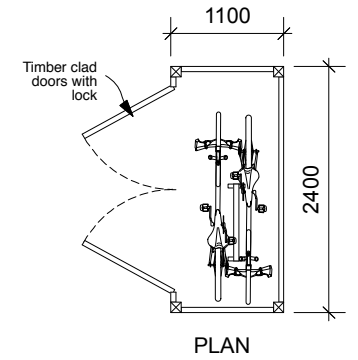

Revisions

**4orm**

1-5 Offord Street London N1 1DH

studio@4orm.co.uk  
 www.4orm.co.uk

Project  
 31 Grafton Road  
 London NW5 3DX

Drawing Title  
 Proposed  
 Cycle Store

Drawing Status  
 PLANNING

Date	Scale @ A3	Drawn
Apr 2018	1:50	LCR

Drawing Number

4099-P.16