

Aluminium Edge/Granite Edge Detail 1

01 597-17500

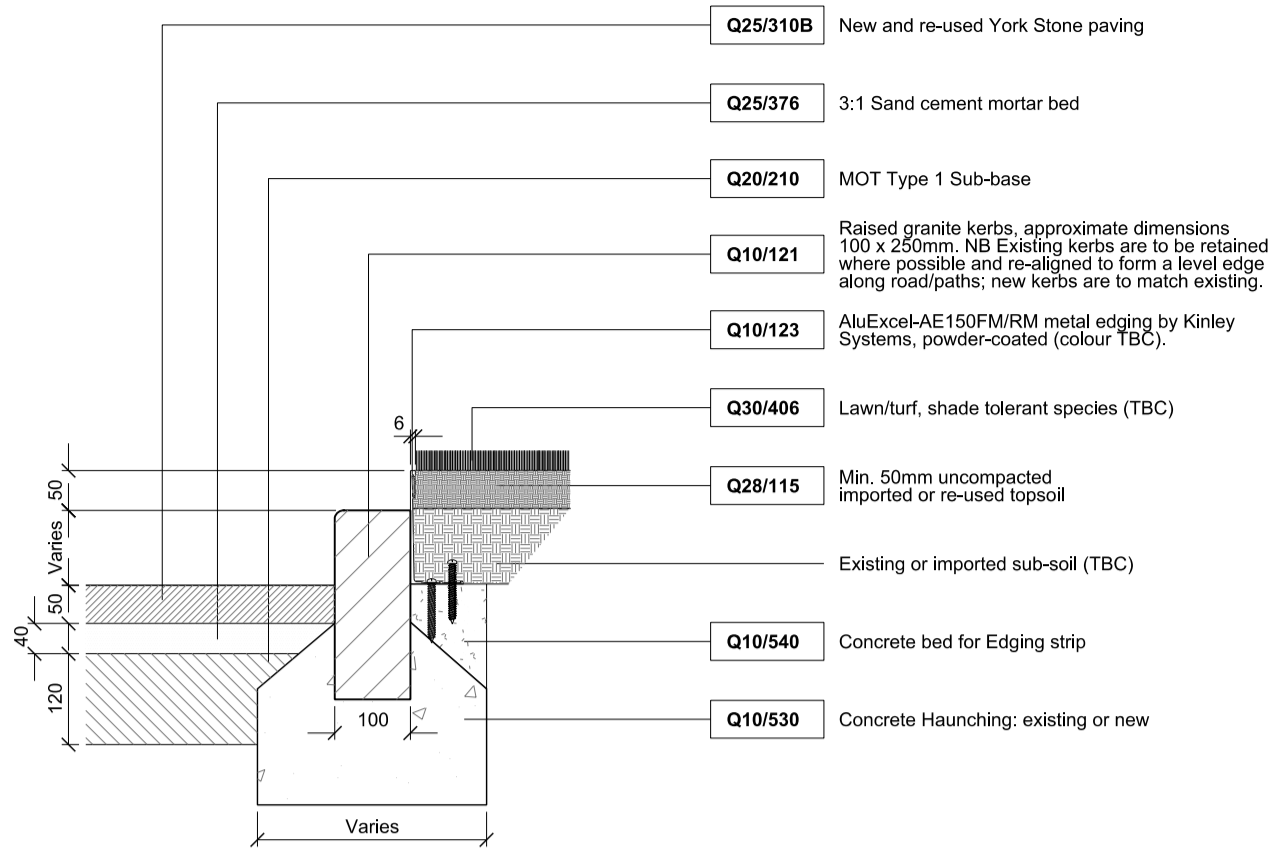

Aluminium Edge/Granite Edge Detail 2

02 597-17500

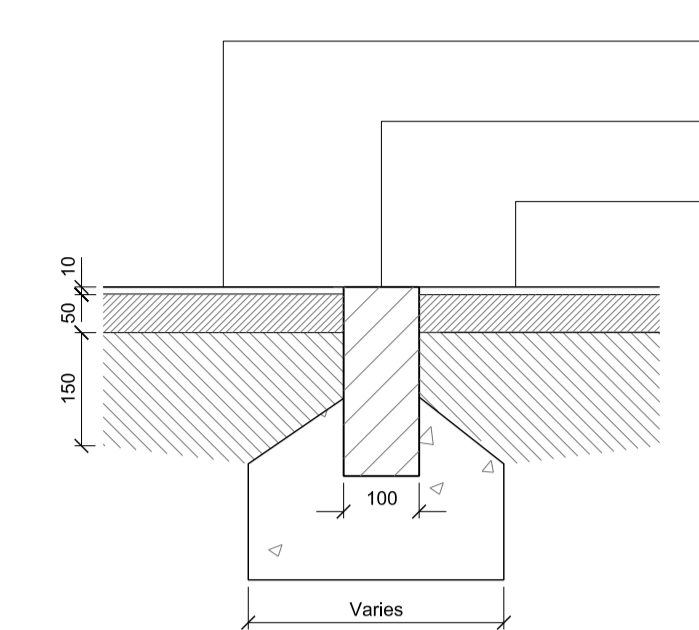

Junction Detail

03 597-17500

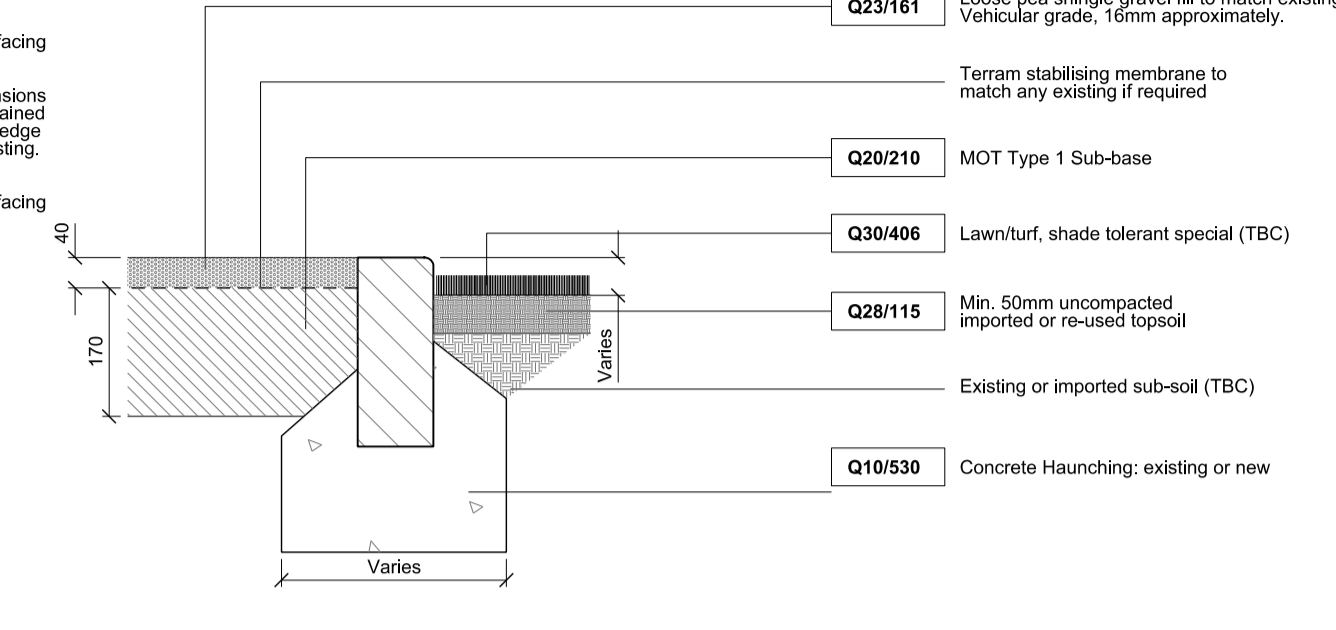

Granite Kerb/Edge Detail 1

04 597-17500

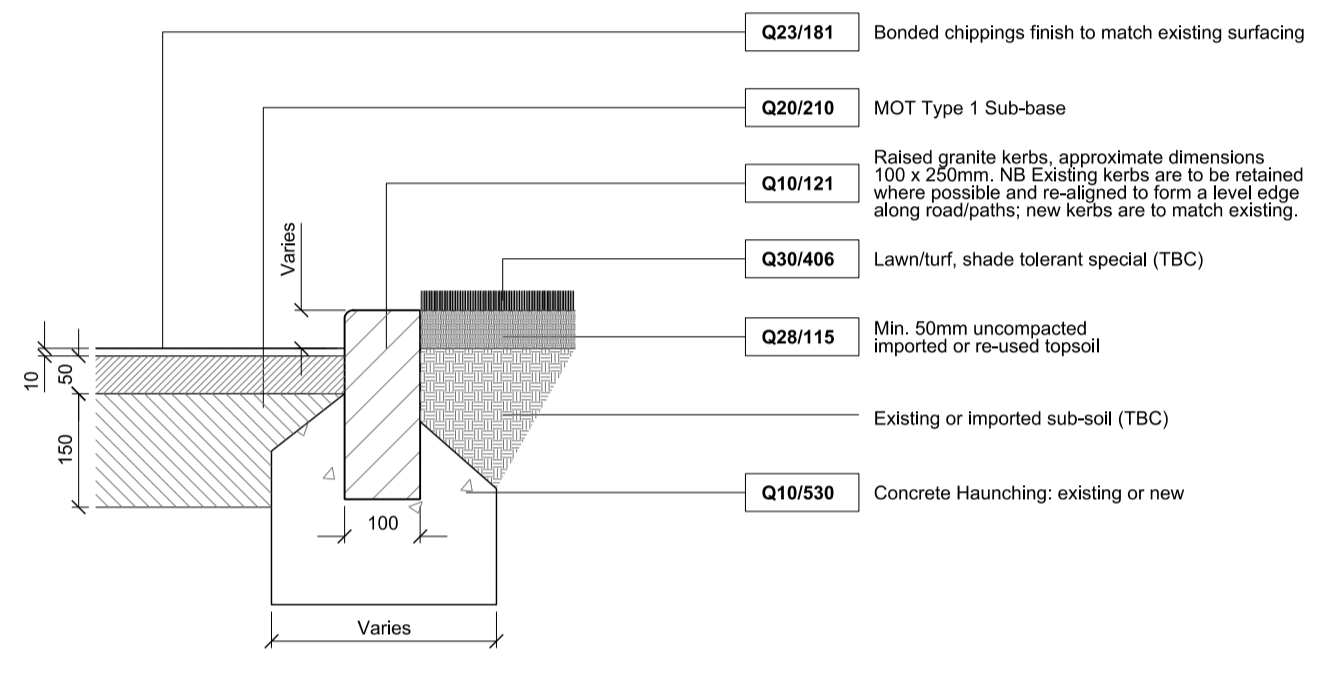

Granite Kerb/Edge Detail 2

05 597-17500

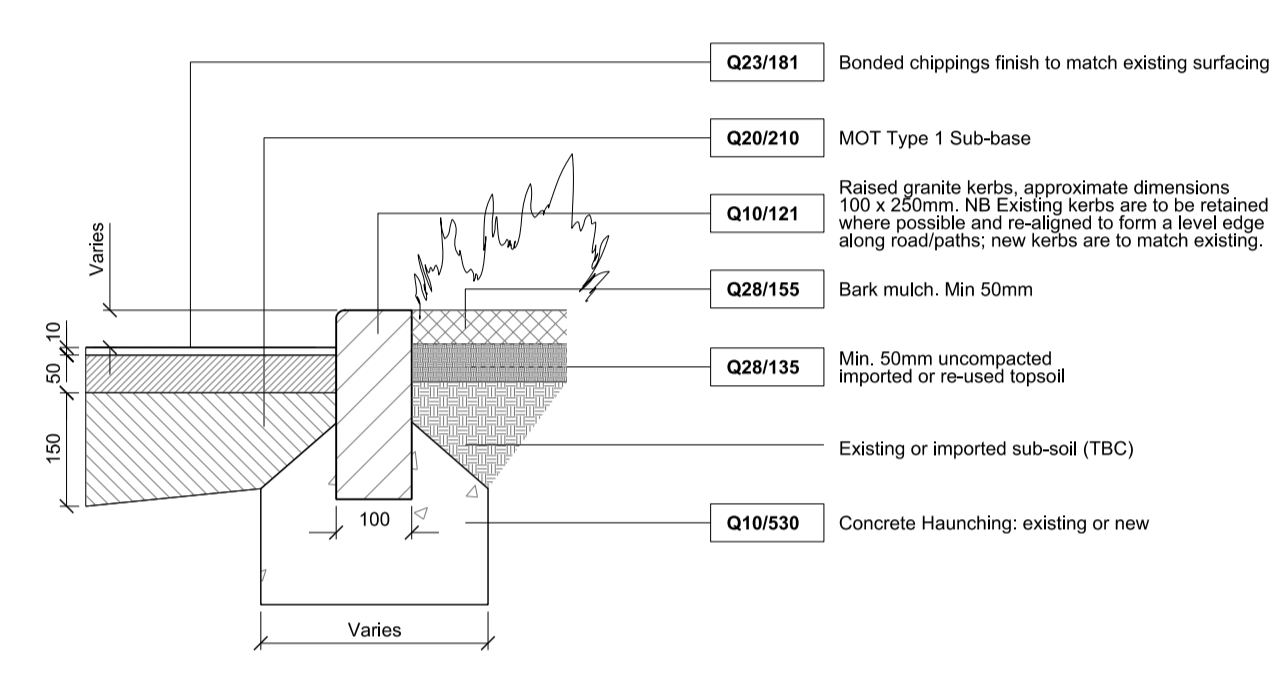

Granite Kerb/Edge Detail 3

06 597-17500

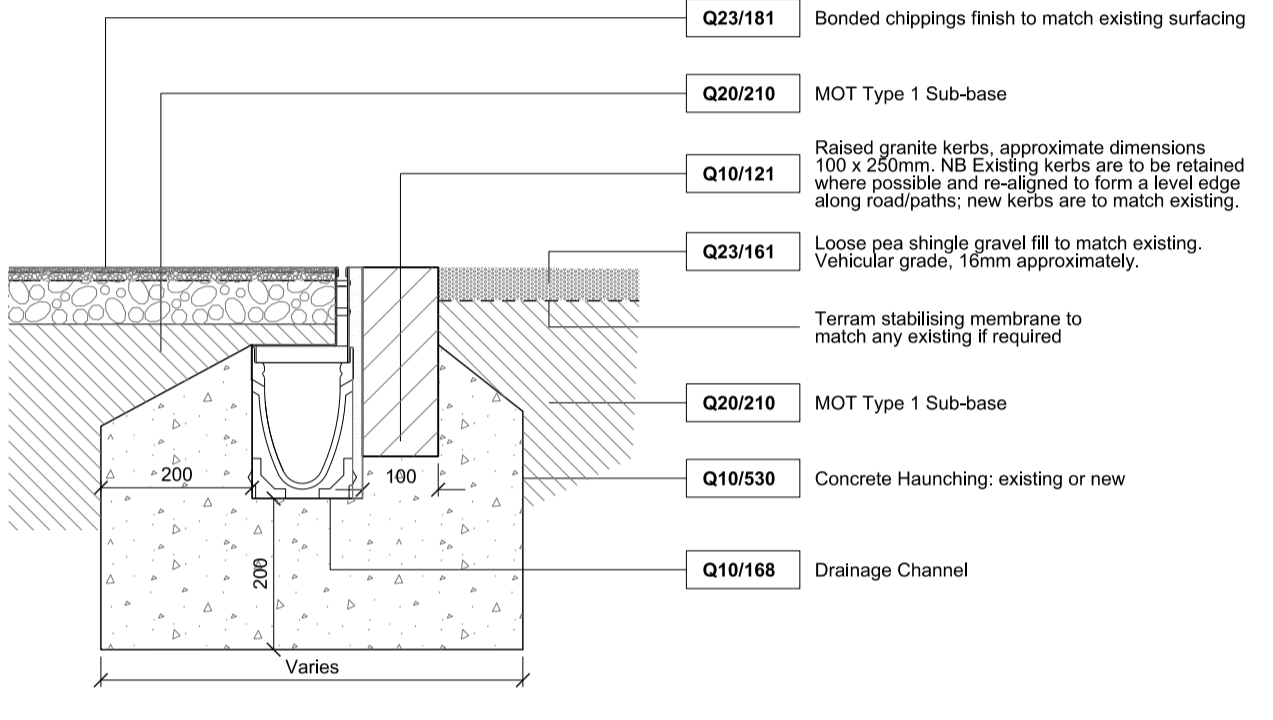

Granite Edge & Gravel/Bonded Gravel Detail

07 597-17500

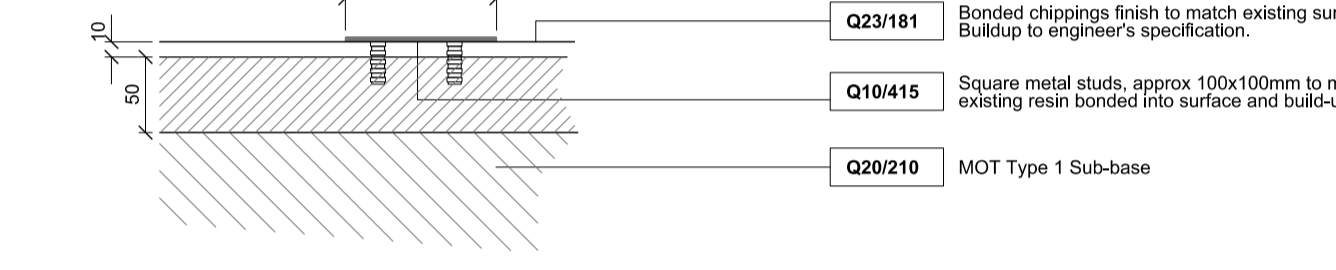

Disabled parking bay metal stud demarcation (1:5)

08 597-17500

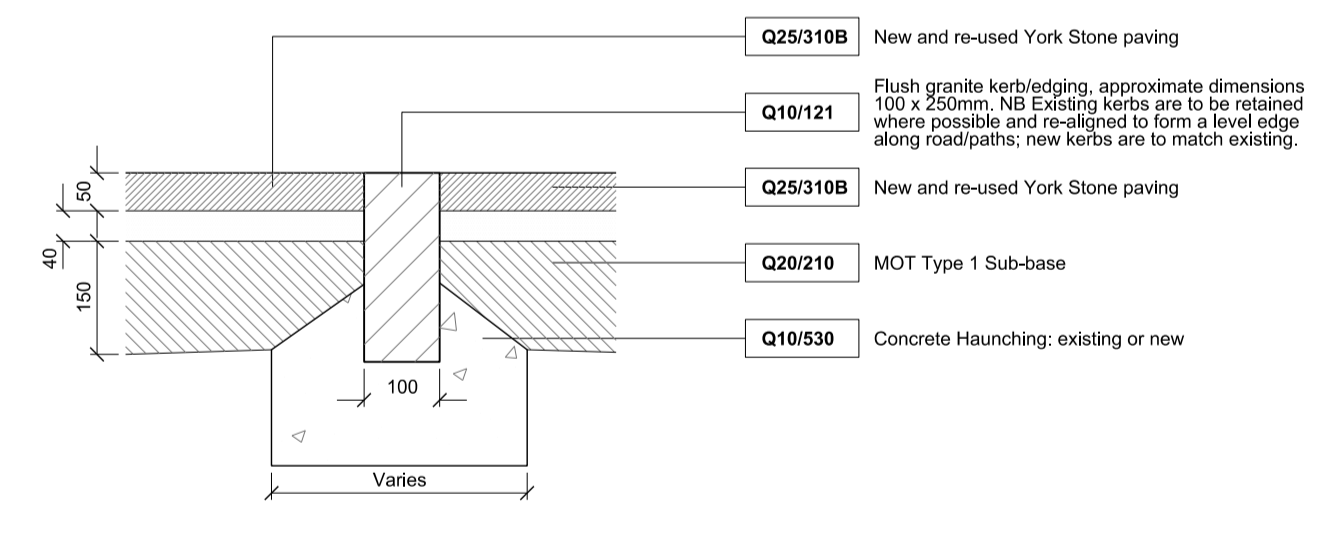

Granite Edge & York Stone Threshold Detail

09 597-17500

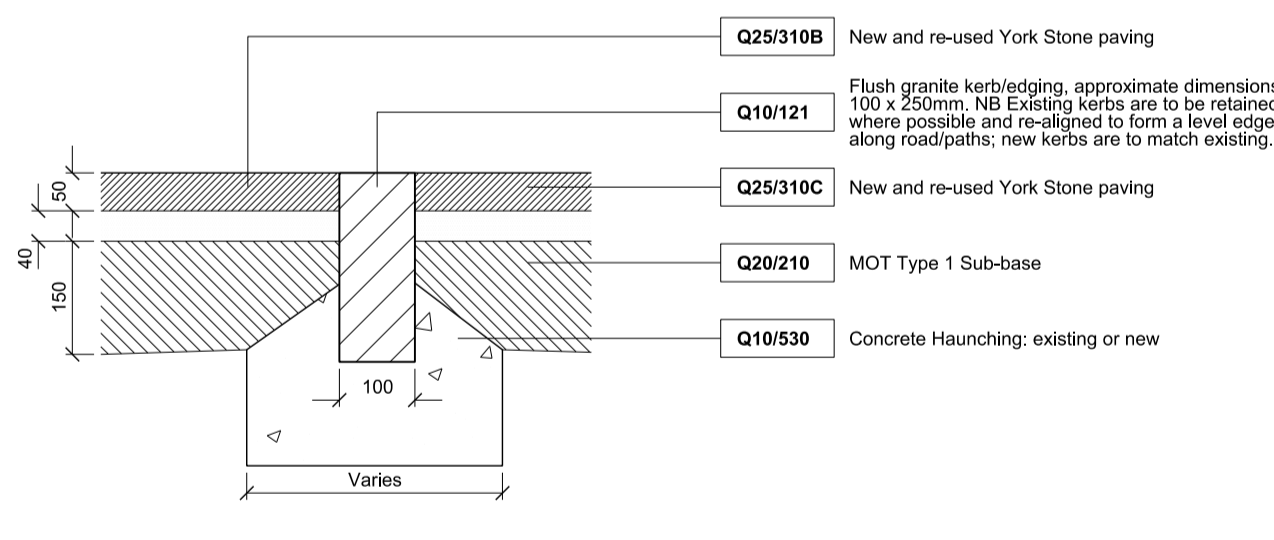

Granite Edge & York Stone Threshold Detail

10 597-17500

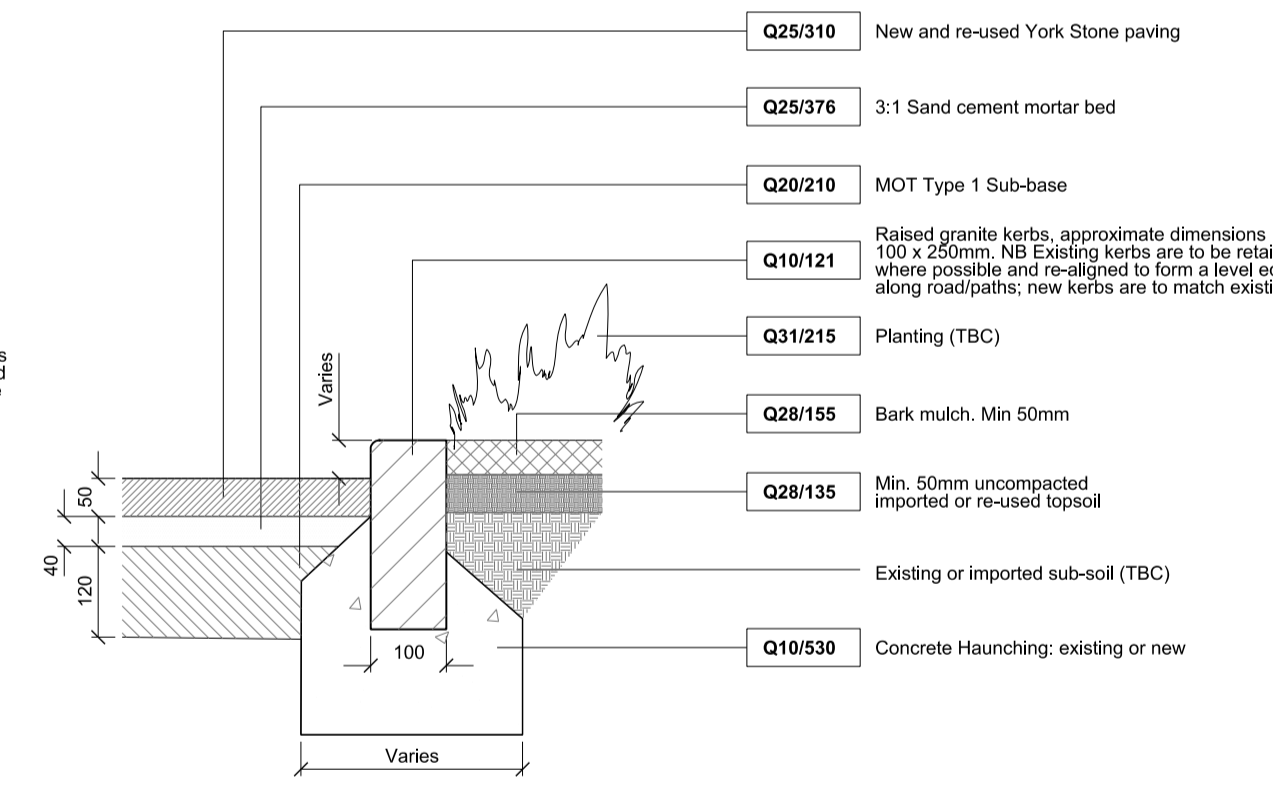

Granite Edge & York Stone Threshold Detail

11 597-17500

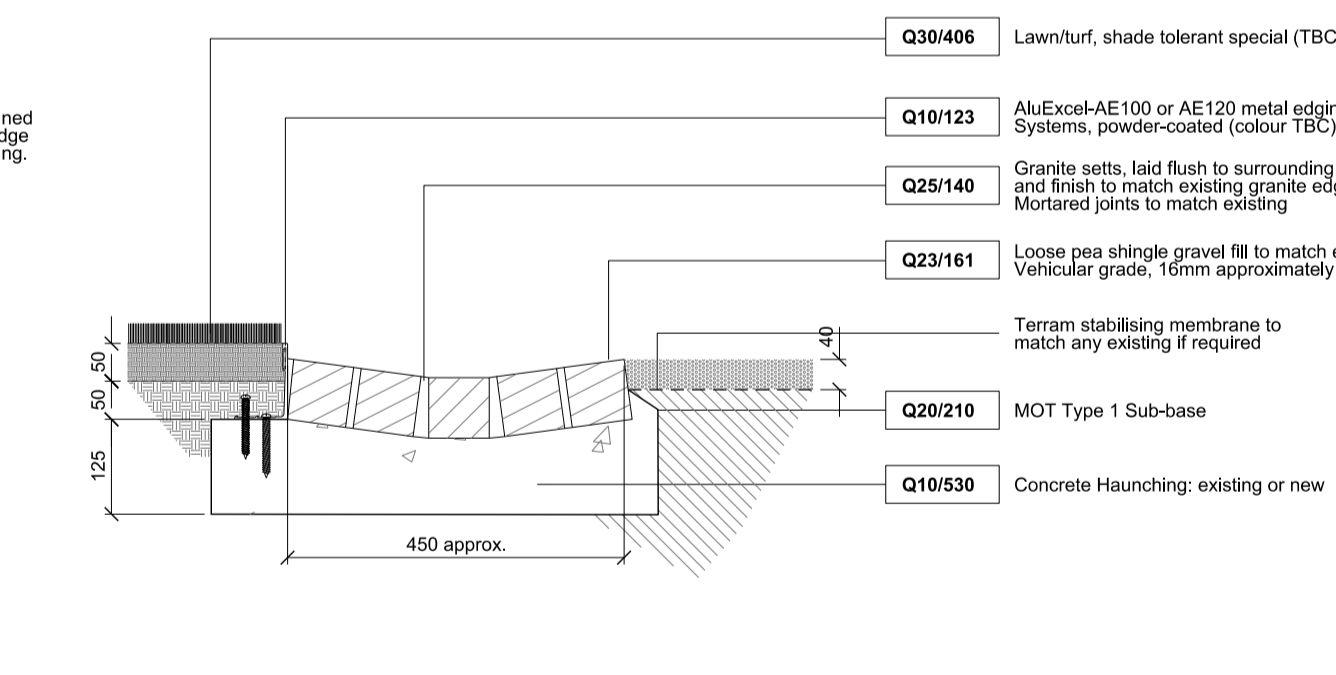

Granite open drainage channel detail

12 597-17500

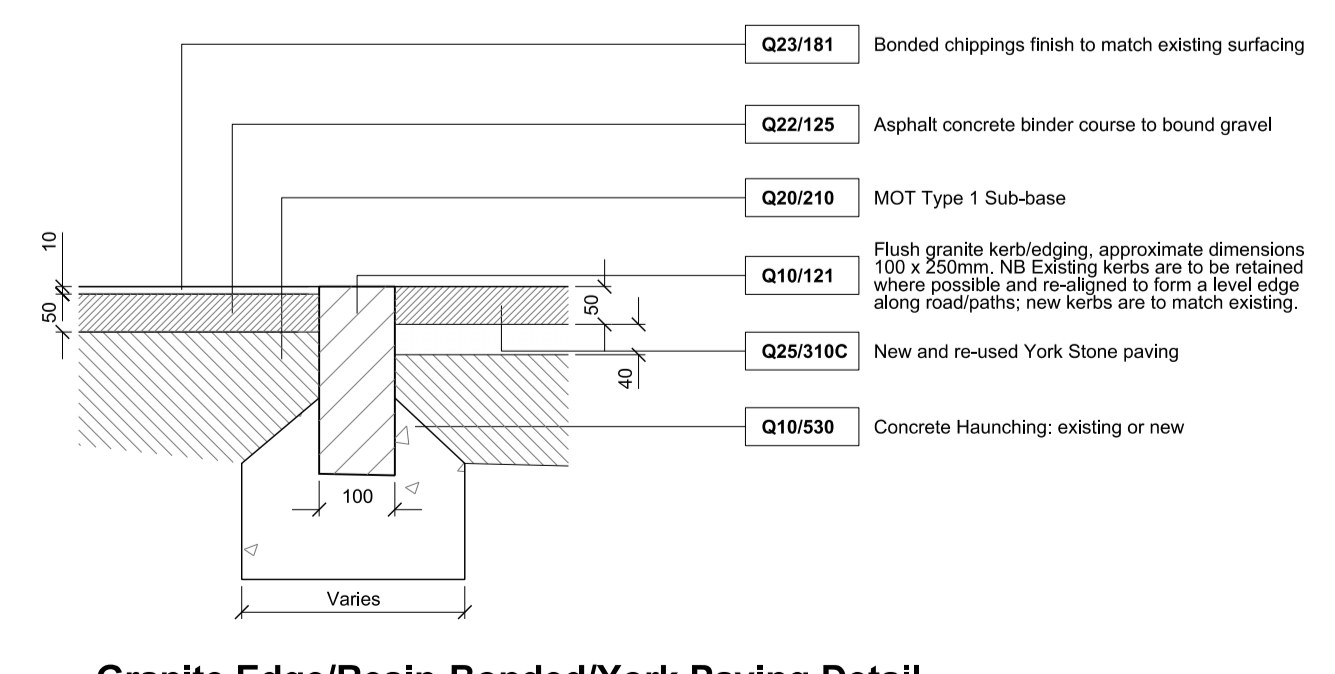

Granite Edge/Resin-Bonded/York Paving Detail

13 597-17500

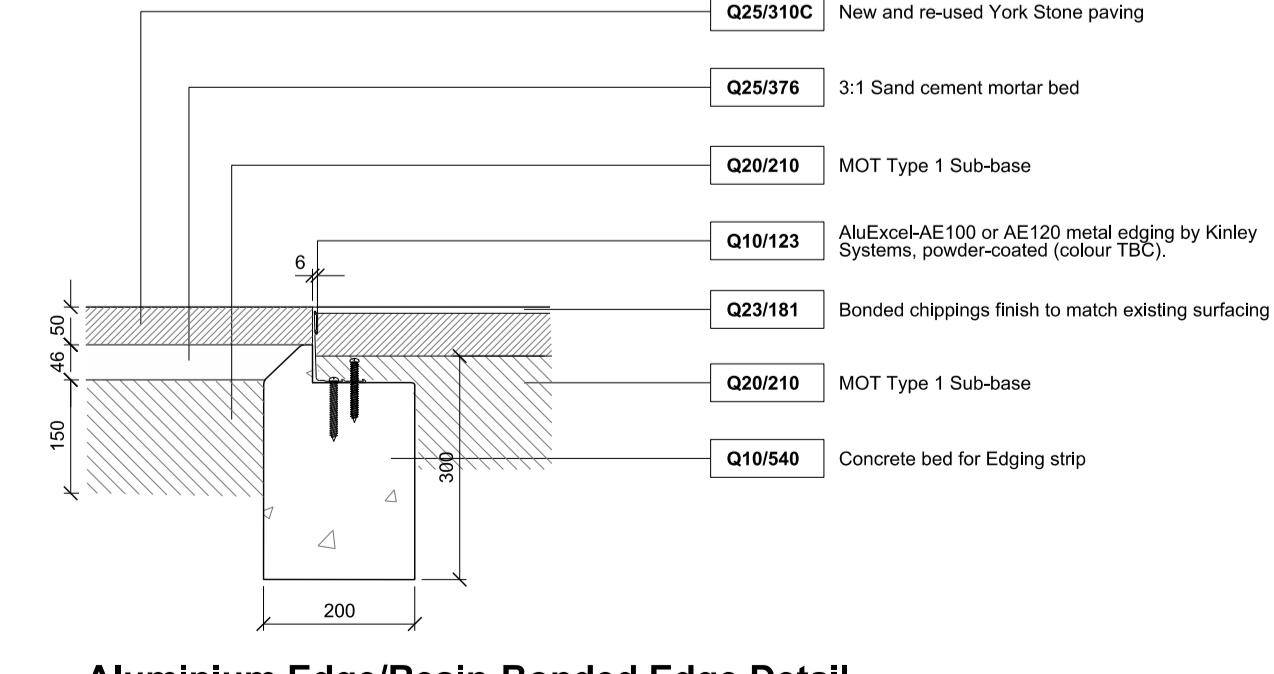

Aluminium Edge/Resin-Bonded Edge Detail

14 597-17500

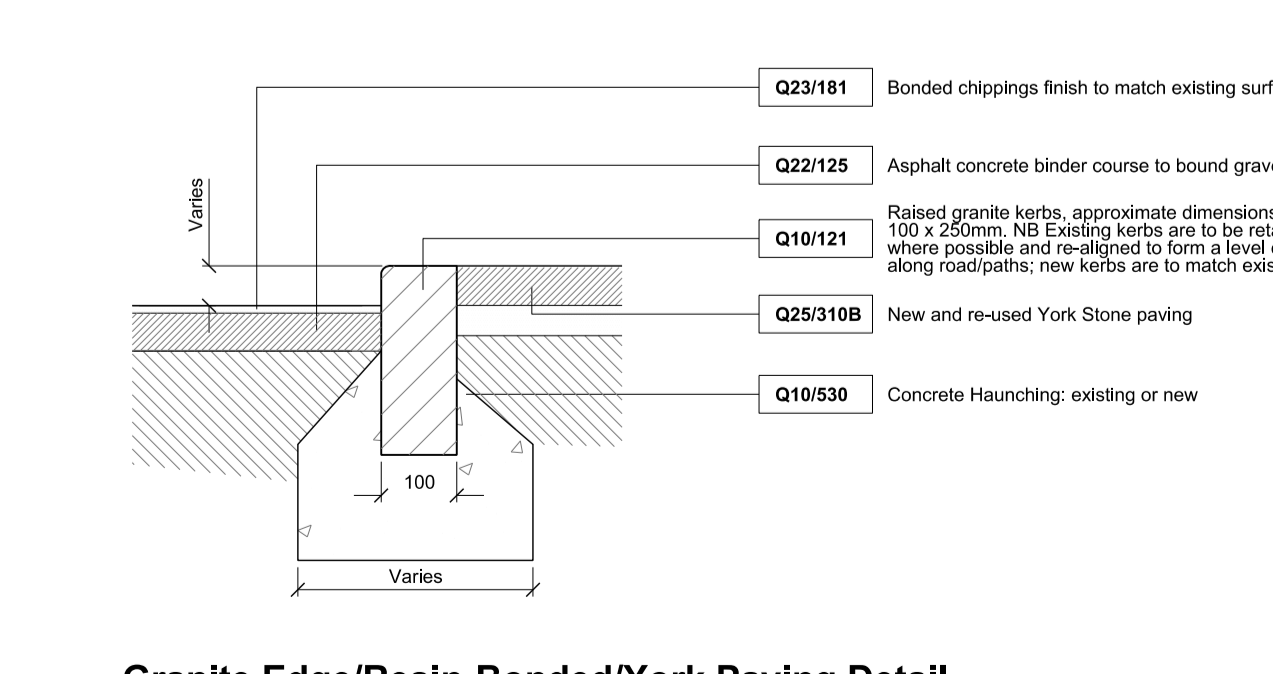

Granite Edge/Resin-Bonded/York Paving Detail

15 597-17500

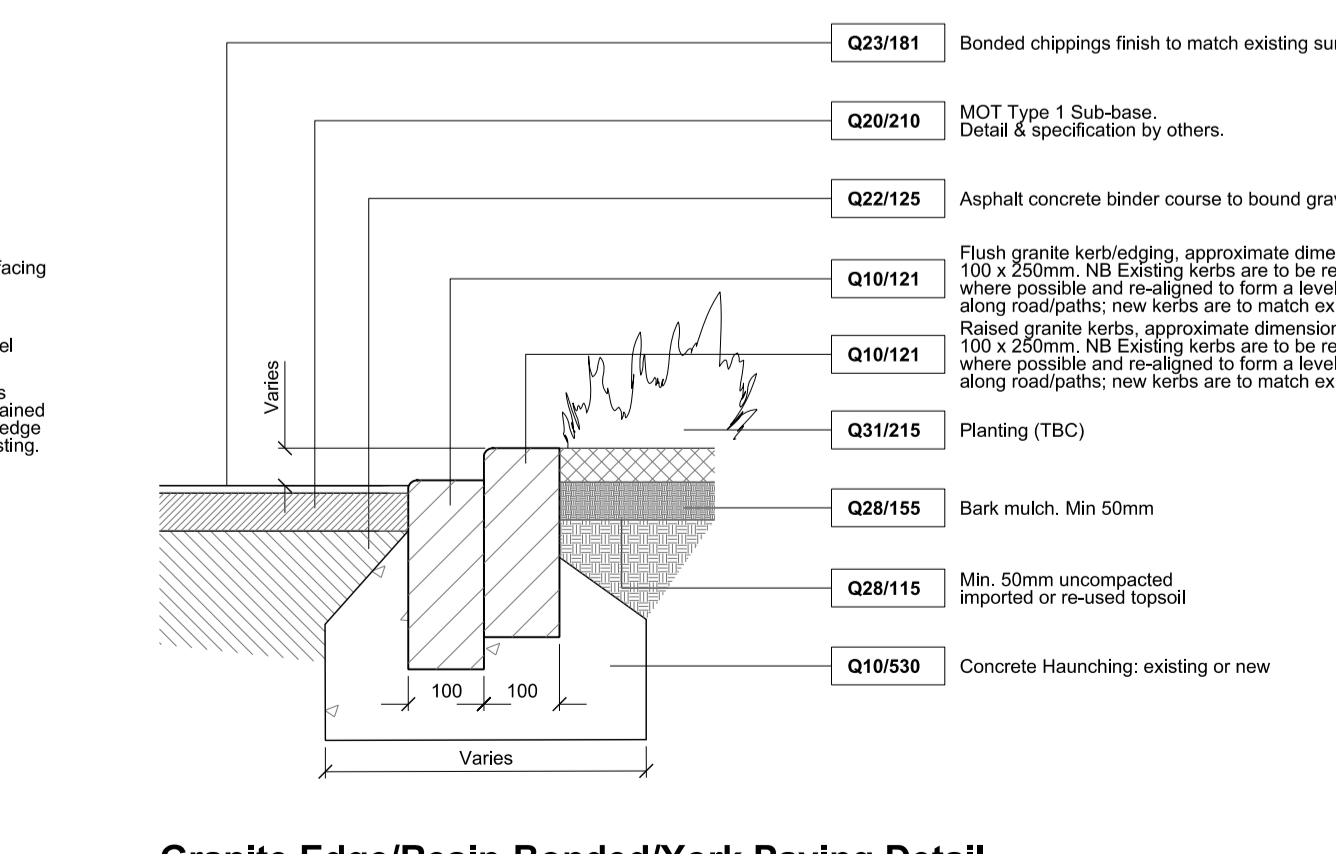

Granite Edge/Resin-Bonded/York Paving Detail

16 597-17500

REVISIONS			
REV	DATE	DESCRIPTION	
C1	02.02.18	CONSTRUCTION	

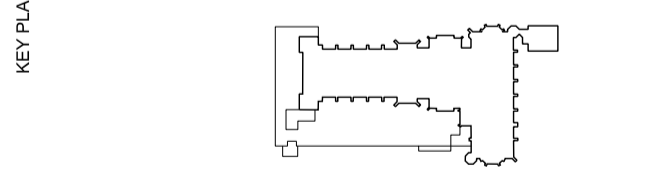

CONSTRUCTION

RICK MATHER ARCHITECTS ©

131 Gordon High Street London N1H 1AH
 T: 020 7241 1021 F: 020 7241 7100
 info@rickmather.com www.rickmather.com

**THE HONOURABLE SOCIETY OF LINCOLN'S INN
 GREAT HALL AND LIBRARY**

TITLE
 GREAT HALL PROJECT
 LANDSCAPE DETAILS 1

DRAWN	JR	JOB #	597	DRG #	17500	REV	C1
CHECKED	TP	SCALE@A1	1:10	SIZE	A1	DATE	FEB 18
		SCALE@A3	1:20		A3	REV DATE	02.02.18