

# Chalk Farm Street Plan

# STATION LAYOUT

Not for construction purposes



Total of 06 Drawings N047-01 to 06	Drawing number: <b>N047-03s</b>
Issue: 17 (2008/09)	Revision:
Survey Date: 03:10:08	Date:
Drawn by: AL	Drawn by:
Information current at date shown. For latest information contact Building Control 020 7088 4357/4356/4361	

If any alterations or additions are needed to these layouts please contact Building Control, Tube Lines Limited.

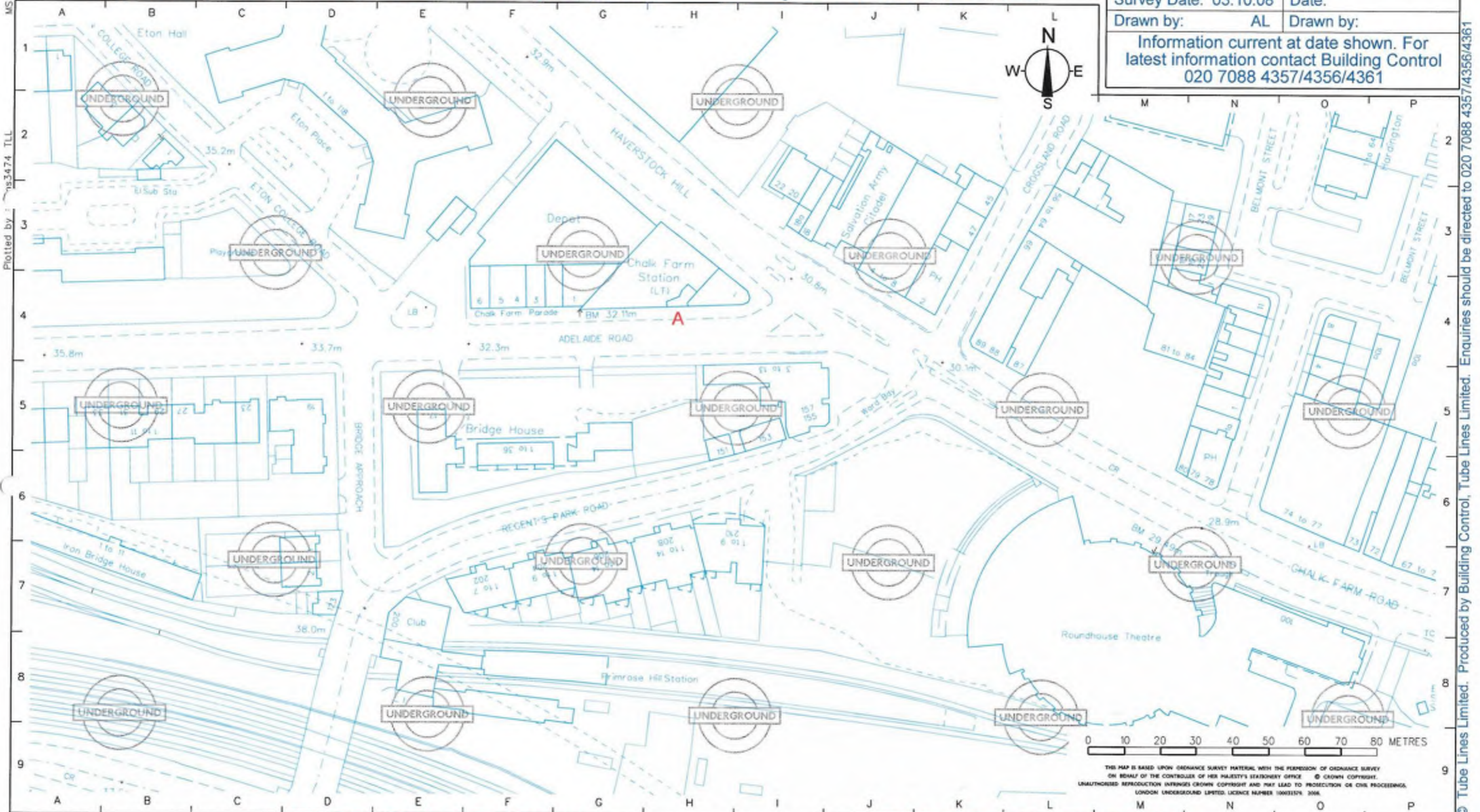

Plotted by: ms3474 TLL

© Tube Lines Limited. Produced by Building Control, Tube Lines Limited. Enquiries should be directed to 020 7088 4357/4356/4361

# Chalk Farm

## Ticket Hall

# STATION LAYOUT

Not for construction purposes



Total of 06 Drawings N047-01 to 06	Drawing number: <b>N047-04s</b>
Issue: 17 (2008/09)	Revision: C
Survey Date: 03:10:08	Date: 15:10:12
Drawn by: AL	Drawn by: MH
Information current at date shown. For latest information contact Building Control 020 7088 4357/4356/4361	

If any alterations or additions are needed to these layouts please contact Building Control, Tube Lines Limited.

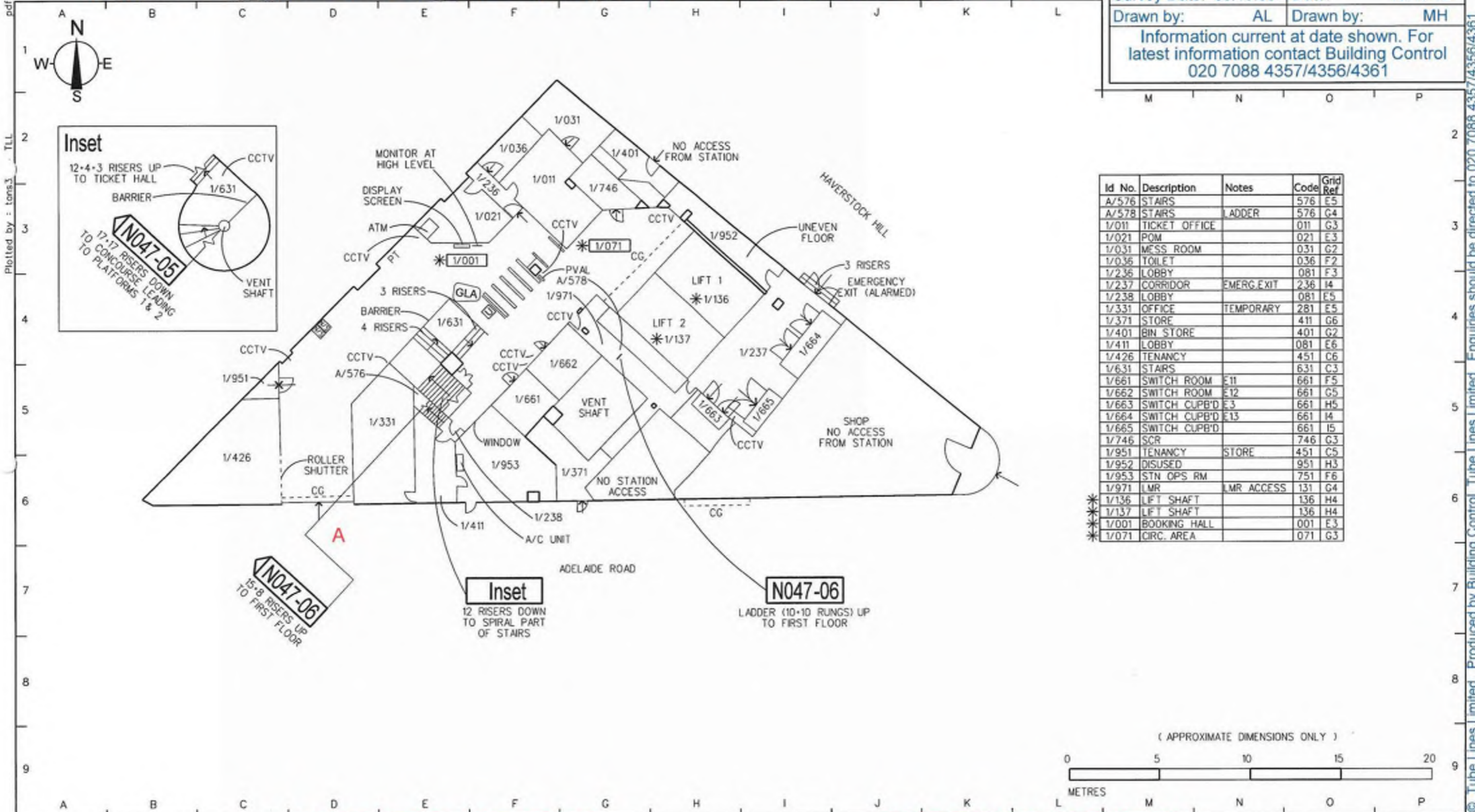

Id No.	Description	Notes	Code	Grid Ref
A/576	STAIRS		576	E5
A/578	STAIRS	LADDER	576	G4
1/011	TICKET OFFICE		011	G3
1/021	POM		021	E3
1/031	MESS ROOM		031	G2
1/036	TOILET		036	F2
1/236	LOBBY		081	F3
1/237	CORRIDOR	EMERG EXIT	236	I4
1/238	LOBBY		081	E5
1/331	OFFICE	TEMPORARY	281	E5
1/371	STORE		411	G6
1/401	BIN STORE		401	G2
1/411	LOBBY		081	E6
1/426	TENANCY		451	C6
1/631	STAIRS		631	C3
1/661	SWITCH ROOM	E11	661	F5
1/662	SWITCH ROOM	E12	661	G5
1/663	SWITCH CUPB'D	E3	661	H5
1/664	SWITCH CUPB'D	E13	661	I4
1/665	SWITCH CUPB'D		661	I5
1/746	SCR		746	G3
1/951	TENANCY	STORE	451	C5
1/952	DISUSED		951	H3
1/953	STN OPS RM		751	F6
1/971	LMR	LMR ACCESS	131	G4
*1/136	LIFT SHAFT		136	H4
*1/137	LIFT SHAFT		136	H4
*1/001	BOOKING HALL		001	E3
*1/071	CIRC. AREA		071	G3

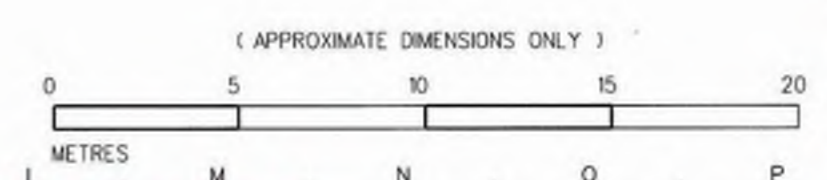

Plotted by: - tons3 - TLL

© Tube Lines Limited. Produced by Building Control, Tube Lines Limited. Enquiries should be directed to 020 7088 4357/4356/4361

# Chalk Farm

## Platforms 1 & 2

# STATION LAYOUT

Not for construction purposes



15 Westferry Circus  
Canary Wharf  
London E14 4HD

Total of 06 Drawings  
N047-01 to 06

Drawing number:  
**N047-05s**

Issue: 17 (2008/09)

Revision: A

Survey Date: 03:10:08

Date: 23:01:09

Drawn by: AL

Drawn by: MH

Information current at date shown. For latest information contact Building Control 020 7088 4357/4356/4361

If any alterations or additions are needed to these layouts please contact Building Control, Tube Lines Limited.

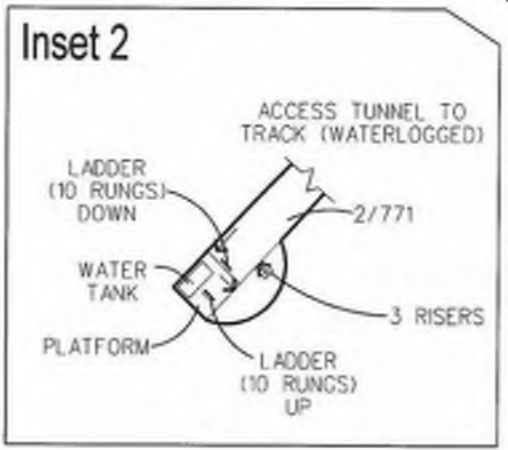
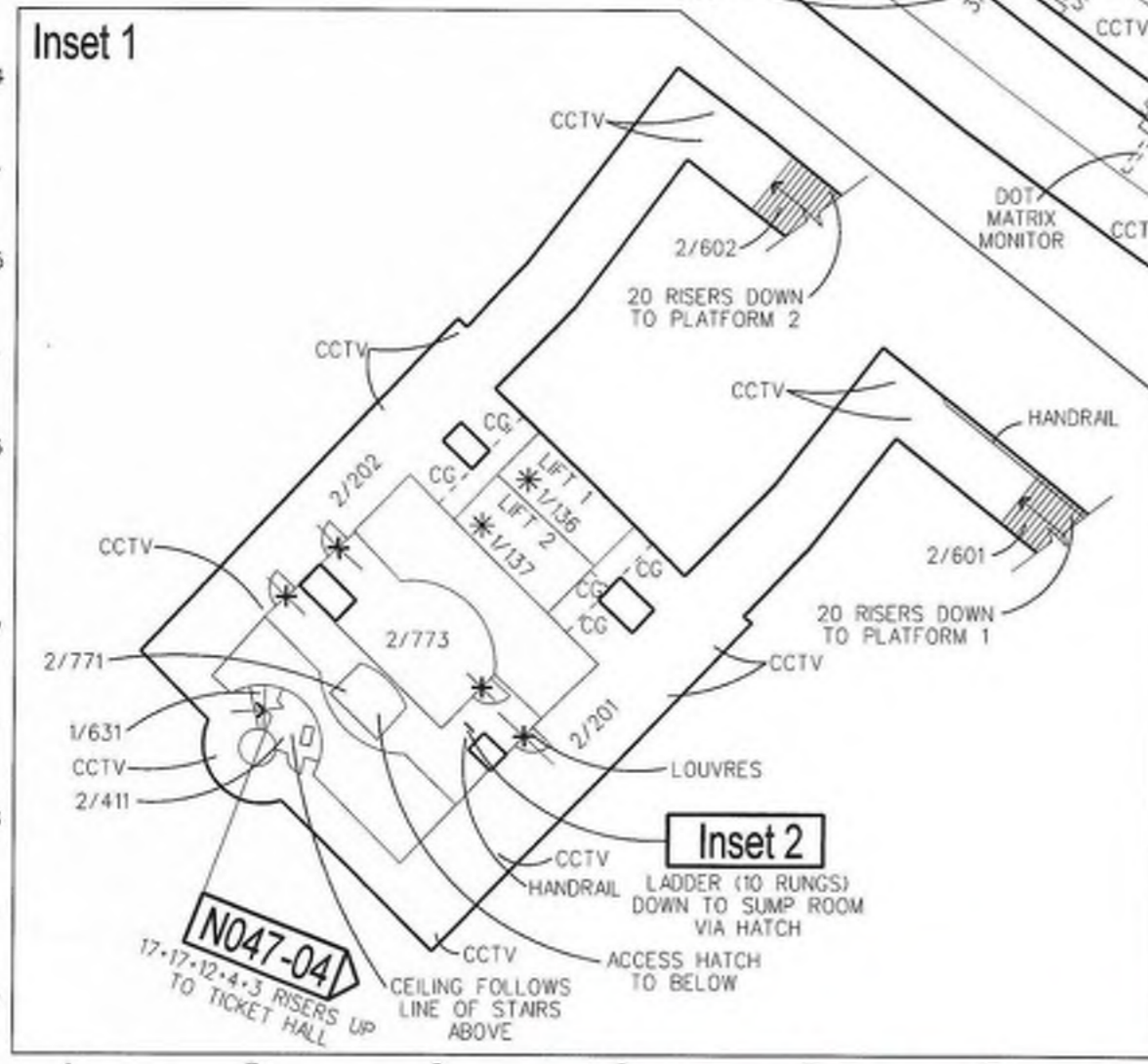
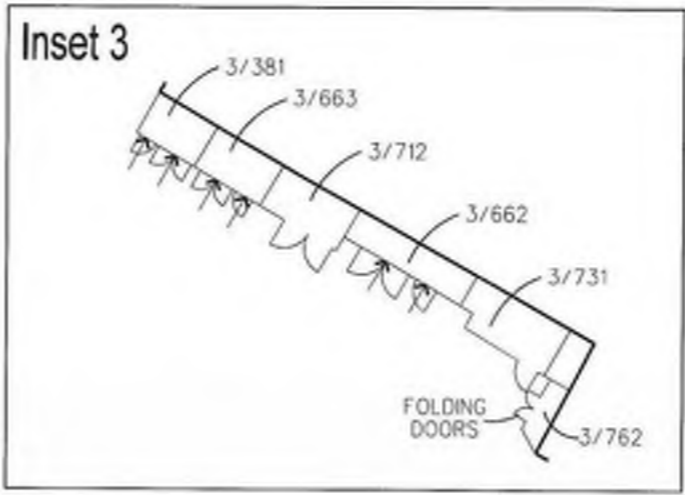
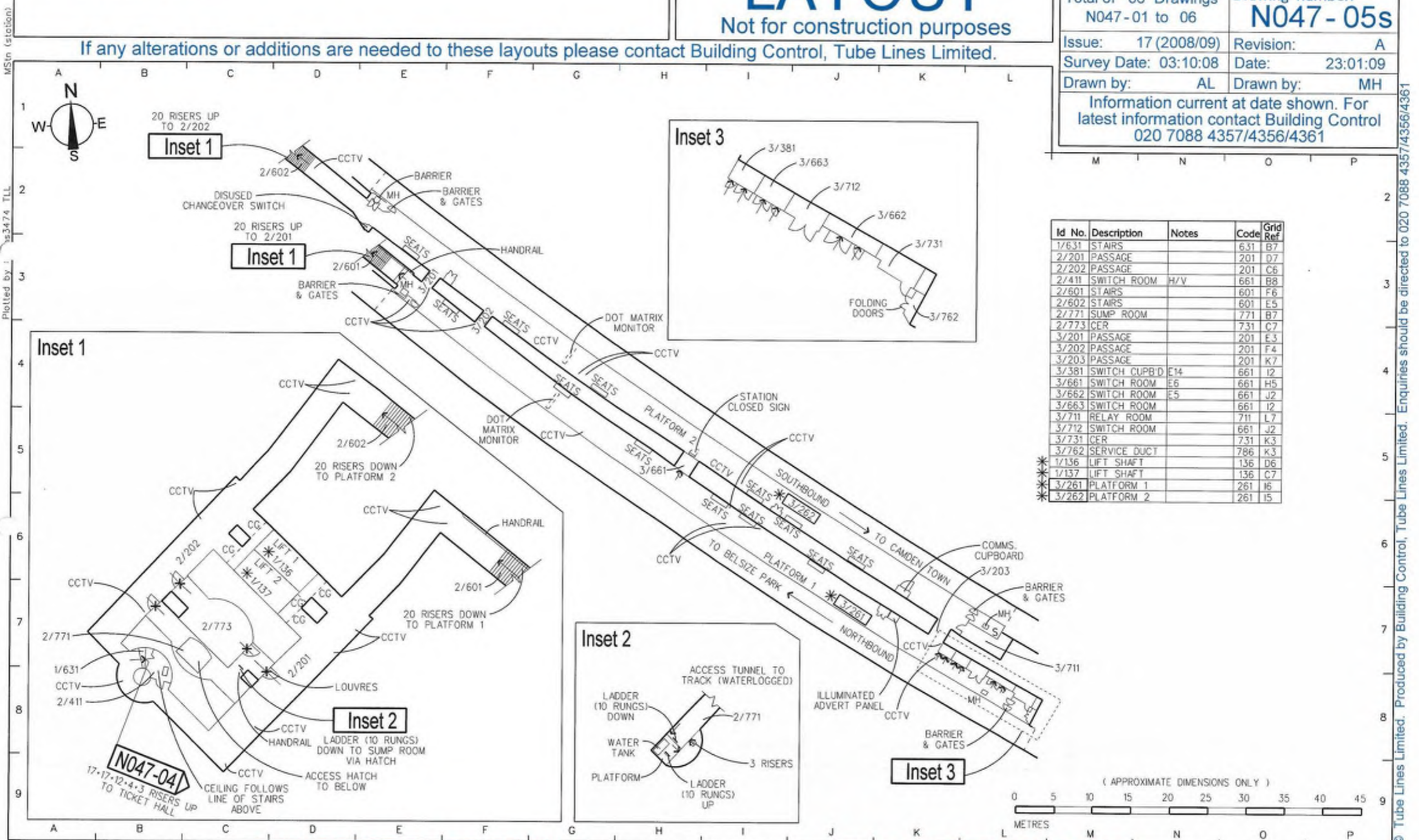

Id No.	Description	Notes	Code	Grid Ref
1/631	STAIRS		631	B7
2/201	PASSAGE		201	D7
2/202	PASSAGE		201	C6
2/411	SWITCH ROOM	H/V	661	B8
2/601	STAIRS		601	F6
2/602	STAIRS		601	E5
2/771	SUMP ROOM		771	B7
2/773	CER		731	C7
3/201	PASSAGE		201	E3
3/202	PASSAGE		201	F4
3/203	PASSAGE		201	K7
3/381	SWITCH CUPB'D	E14	661	I2
3/661	SWITCH ROOM	E6	661	H5
3/662	SWITCH ROOM	E5	661	J2
3/663	SWITCH ROOM		661	I2
3/711	RELAY ROOM		711	L7
3/712	SWITCH ROOM		661	J2
3/731	CER		731	K3
3/762	SERVICE DUCT		786	K3
*1/136	LIFT SHAFT		136	D6
*1/137	LIFT SHAFT		136	C7
*3/261	PLATFORM 1		261	I6
*3/262	PLATFORM 2		261	I5

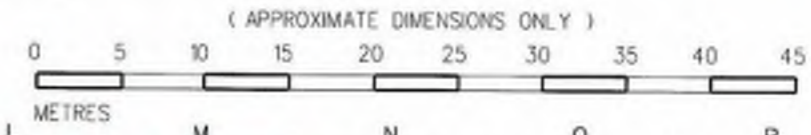



engineeria ltd  
Registered in England and Wales  
Company Number: 09029050  
Registered Office:  
145-157 St John Street  
EC1V 4PW, London