

VMZ Standing seam

Non-ventilated and ventilated roof systems

Design and specification requirements

Uniclass	G312:G24:P45	
Cl/SfB	(47)	Mh7
January 2016		



VMZ Standing seam

Contents



Company profile VMZINC® manufactures a wide range of rolled zinc products for use in construction and has almost two centuries of experience. In addition to the standing seam system, products include rainwater systems, cladding systems and decorative roofing products such as dormers, bull's eyes, weather vanes, finials and balustrades. VMZINC is part of the Umicore Group which has worldwide interests in precious metal services, recycling of non-ferrous metals, and catalyst technologies for the automotive industry. It also manufactures substrates for photovoltaics and LEDs, materials for photonics and lenses, and optical assemblies for night vision applications.

Front cover building credit: MBM Arquitecto

- 3 **Why use the VMZ standing seam system?**
- 4 **Sustainable performance**
- 6 **The system**
 - Underlying principles
- 8 **Surface finishes**
- 12 **Warm roofs (non-ventilated)**
 - Introduction
 - 14. Standing seam on rigid insulation – Structural Roof
 - 16. Standing seam on cellular glass insulation – Compact Roof (Only solution for high humidity buildings such as swimming pools)
 - 18. Standing seam on insulated metal-faced panels
 - 20. Standing seam on plywood bonded to phenolic foam
- 24 **Cold roofs (ventilated)**
 - Introduction
 - 26. Standing seam on vented plywood
 - 28. Standing seam on open-gap timber boarding
- 32 **Technical drawings**
- 36 **Further technical information**
- 37 **Standing seam facades**
- 38 **Heritage – batten cap roofing**
- 39 **Other VMZINC systems**
 - Rainwater systems
 - Rainscreen facades



VMZ Standing seam

Why use the VMZ standing seam system?

Introduction Zinc is among the most sustainable metals used in construction today and has been used on the roofs of Paris for almost 200 years. The VMZ standing seam system is also highly cost-effective, both from an initial procurement and design life perspective.

Whether for new build or refurbishment, the VMZINC standing seam system has been designed to complement a wide range of building materials and styles. The finishes available offer exceptional colour stability. This ensures that maintenance requirements will be minimal throughout the system's design life and that the material's installed appearance will be retained for many years.

VMZINC's versatile standing seam system can be used for warm or cold roof constructions. Some of its many benefits are listed below.

Benefits of the VMZ standing seam system

- Lightweight and durable
- Minimal expansion and creak
- Fully recyclable
- A design life of 80 years
- Virtually maintenance-free
- Can be installed on pitches from 3°-90°
- Complex shapes can be easily achieved. Zinc panels can be pre-curved to a radius as low as 600mm
- Can be used to cover soffits (box gutter overhangs, etc)
- BRE Green Guide certified
- BBA certified
- Conforms to EN 988
- Can be laid in lengths up to 13 metres without the need for expansion steps
- Fire performance rating 'AA' - BS 476: Part 3 ('low vulnerability' class in Scotland)
- Available in a choice of either natural finish or 7 pre-weathered finishes

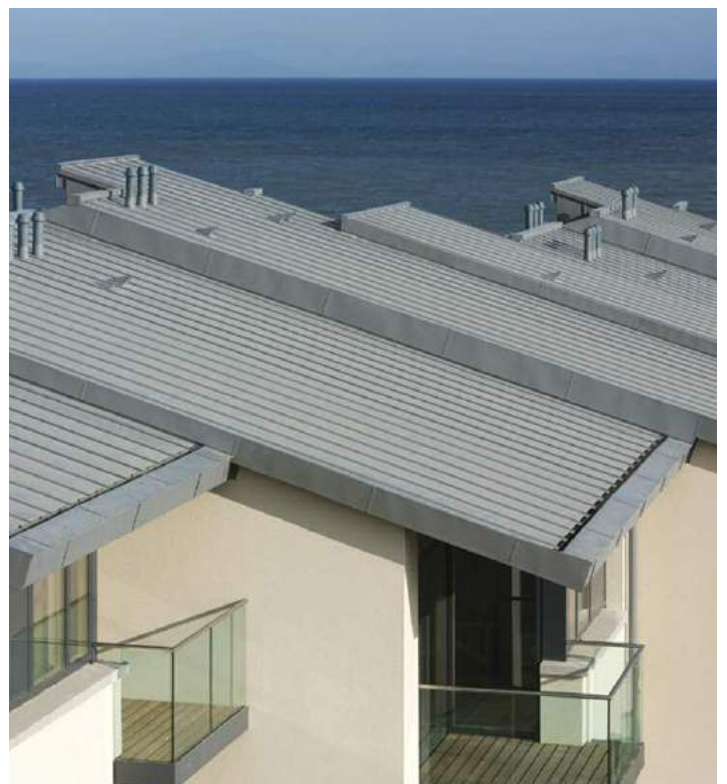

VMZ Standing seam

Sustainable performance

Low energy used in the manufacturing process

VMZINC rolled zinc products are used in construction industries throughout the world for their sustainability, distinctive appearance, and low maintenance requirements. As with VMZINC facade and rainwater systems, manufacturing processes for our standing seam system presents a low environmental impact, particularly with regard to energy expenditure.

As the comparative energy expenditure diagram opposite shows, less energy is required to extract zinc from the ground than the other principal metals, and is even more favourable for recycled zinc. Such minimal use of energy in the production of zinc clearly indicates its contribution to sustainable development.

Recycled material

95% of old rolled zinc recovered every year in Western Europe, currently estimated at 100,000 tonnes, is reused. This represents savings in mining resources of between 1 and 2 million tonnes.

Low corrosion, long life

The VMZ standing seam system benefits from zinc's self-protecting patina which develops as a result of exposure to water and carbon dioxide. Over the last 50 years the quantity of sulphur dioxide in the atmosphere has been greatly reduced. SO₂ being the key agent of corrosion means that corrosion rates are now 1µm per year. With an initial thickness of 0.7mm, the estimated life span of rolled zinc is over a hundred years.

A natural material

VMZINC undertakes Life Cycle Analysis (LCA) tests on its products and publishes Environmental Product Declarations (EPDs), such as BRE Environmental Profiles, available from our website www.vmzinc.co.uk and www.greenbooklive.com. These provide users with comprehensive, reliable and transparent information on relevant environmental characteristics. The information is also used by VMZINC as the basis for its eco-design approach.

Comparative energy expenditure in manufacture

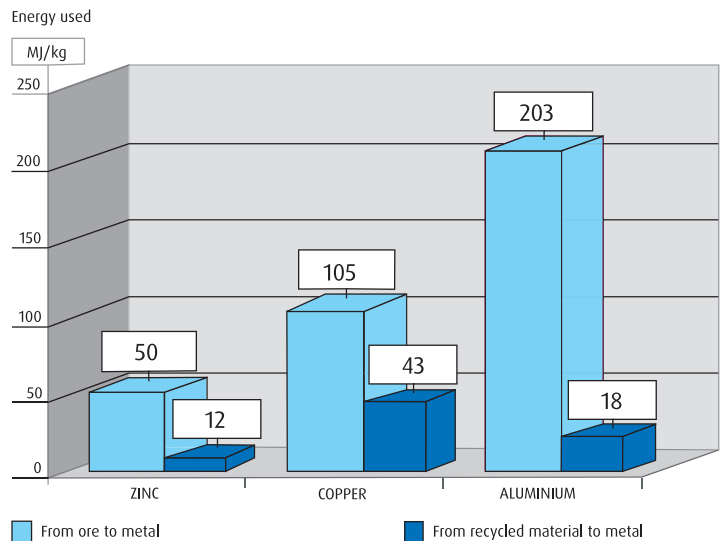

Compared with other metals, very little energy is needed to manufacture zinc metal from ore – less than half the consumption of copper and stainless steel and less than a quarter of that used for aluminium. CO₂ and other greenhouse gas emissions are also, therefore, proportionally less.



VMZ Standing seam

Sustainable performance

BRE Environmental profiles measure the impacts of a construction material, product or building system throughout its life, not only during its manufacture, but also its use in a building over an 80 year period. This includes its extraction, processing, use and maintenance and its eventual disposal.



VMZINC has been audited and reviewed by BRE Global. The Life Cycle Assessment (LCA) modelling derives a Certified Environmental Profile and a Green Guide rating has been produced.

A wide range of zinc roofing and cladding systems has been audited with the systems receiving a Green Guide rating of up to **A+**. These profiles can then be applied to the BREEAM (BRE Environmental Assessment Method) allowing VMZINC to contribute to schemes such as the Code for Sustainable Homes.



OHSAS 18001 Since 2009, VMZINC has been OHSAS 18001 certified, thus conforming to occupational health and safety management systems.



ISO 14001 VMZINC manufacturing plants have conformed to ISO 14001 since 2004/5 so processes are strictly controlled to ensure that emissions are significantly below the national regulation threshold.



ISO 9001 ISO 9001 is the internationally recognised standard for the quality management of businesses and applies to all Umicore/VMZINC products and services. Certification was originally obtained in 1997 and updated in November 2003 to conform to ISO 9001: 2000.



VMZ Standing seam

The system

Underlying principles

Introduction The standing seam system consists of a comprehensive range of robust components that ensures appropriate and correct installation is achieved. It is also important that standing seam roofs are installed by properly trained and equipped professionals.

Individual panels are held in place at the top of the pitch by a minimum of 5 fixed clips and then towards the lower portion of the panel by sliding clips allowing thermal movement. These stainless steel clips, which are fixed to the structure, are crimped inside the joints. Thus the fixing clips for panels and flashings never penetrate the material and therefore do not affect the appearance or damage the waterproofing. The low height of the seams (25mm standard) and the 600mm maximum spacing between joints give the roof a light, harmonious appearance.

The standing seam system is available in various standard coil dimensions shown in the table on the opposite page. Non-standard widths between 60mm and 600mm can also be produced.

The standing seam panels weigh approx 6kg per m².

See pages 8 and 9 for samples of the 7 finishes available.

The system is eminently suitable for warm roof constructions (pages 12-21) and for cold roof constructions (pages 24-29).

VMZINC PLUS VMZINC PLUS is a unique patented product that allows zinc to be installed on ventilated plywood (page 26) as well as specific warm (non-ventilated) substrates (pages 12-21). The product consists of VMZINC (in all finishes) having a 60µm coating applied to the underside thus allowing a more varied amount of substrates to be used and eliminating the risk of the formation of white rust on the underside of the zinc standing seam panels. VMZINC PLUS resists to an abrasion of 40 litres when tested in accordance with ASTM D 968.

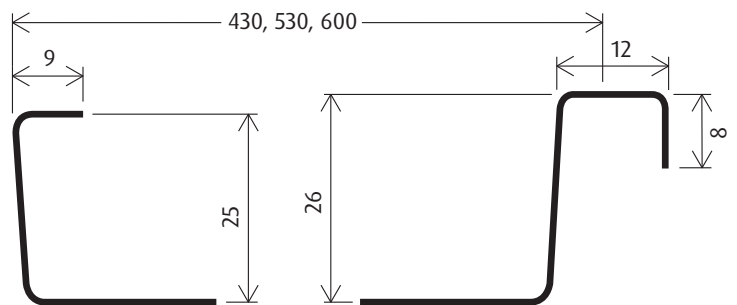

Panel dimensions (mm)

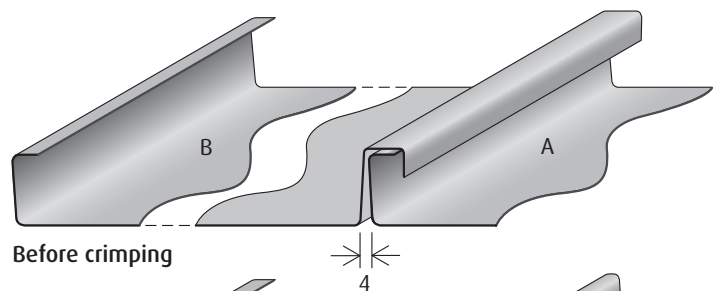

Before crimping

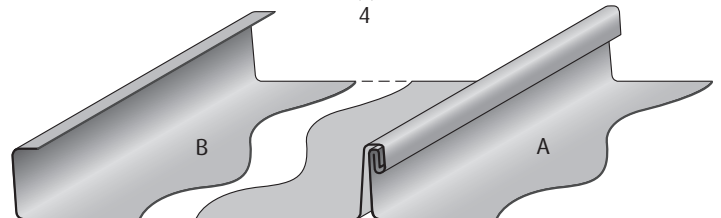

After crimping (double lock standing seam)

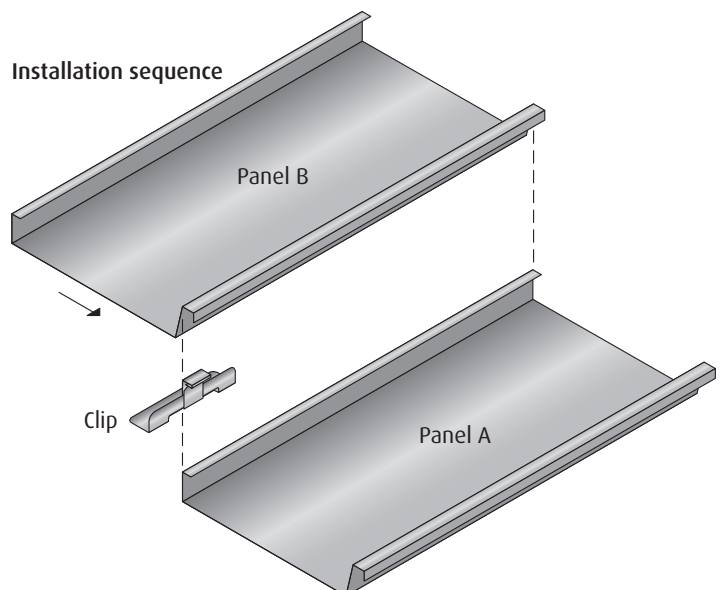

1. Position panel A
2. Engage clips to upstand of panel A and screw fix to substrate
3. Engage edge of panel B over clip
4. Crimp all 3 components together to form double lock standing seam

VMZ Standing seam

The system

Underlying principles

Please contact us
for further
design assistance



BBA VMZINC has 2 BBA Certificates for non-ventilated warm roof systems – the Structural Roof and the Compact Roof. See pages 14 to 17.

BBA certified systems give a wide range of benefits. For over 40 years agrément certificates have been supplied by the BBA in order to give unbiased information on the performance of a system. By selecting a BBA system an architect is sure to avoid problems at a number of stages in the building process and queries about the performance of key products. By using BBA certified systems contractors also know that they will perform, if installed in accordance with the guidance in the Certificate.

VMZINC accessories VMZINC supply a number of accessories ranging from a breather membrane (page 36) to fixing clips (page 36) and flashings such as the G3 ridge, eave and verge.



Standing seam coil dimensions

Surface finish	Coil thickness (mm)	Coil width (mm)	Standing seam centres (mm)
Natural zinc	0.70 or 0.80	500, 600 or 670	430, 530 or 600
QUARTZ-ZINC	0.70 or 0.80	500, 600 or 670	430, 530 or 600
ANTHRA-ZINC	0.70 or 0.80	500, 600 or 670	430, 530 or 600
PIGMENTO	0.70 or 0.80	500, 600 or 670	430, 530 or 600
AZENGAR	0.70 or 0.80	500*	430*

All the above surface finishes are available as Standard and PLUS products. *For other dimensions please consult us.

Standing seam zinc roofing will not give a perfectly flat finish. However, by reducing panel width and increasing zinc thickness, unevenness will be reduced.

VMZ Standing seam

Surface finishes

Natural VMZINC® Natural VMZINC has a shiny metallic appearance when new and develops a patina over time. In facade applications, it may take 10 years for the matt grey patina to form. It can be quickly soldered without removing the patina.

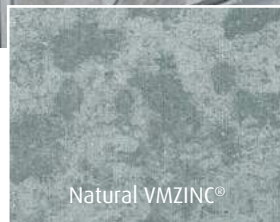

Natural VMZINC®

QUARTZ-ZINC® QUARTZ-ZINC offers an appearance and texture that does not change over time. When QUARTZ-ZINC is scratched, it will self heal. The grey tones of QUARTZ-ZINC blend well with existing construction materials - ideal for refurbishment.



QUARTZ-ZINC®

ANTHRA-ZINC® ANTHRA-ZINC with its visible grain matches the colour of slate and blends well in combination with photovoltaic panels.



ANTHRA-ZINC®

AZENGAR®
New AZENGAR is the new surface finish from VMZINC which is the first engraved zinc giving a product with a matt, heterogeneous and light aspect. AZENGAR can be used in the same fashion as other VMZINC products for both roofs and facades. AZENGAR PLUS is now available.



AZENGAR®

VMZ Standing seam

Surface finishes

Please contact us
for
samples

PIGMENTO® PIGMENTO finishes offer a unique range of colours that enhances any building. This natural product enables the texture of the QUARTZ-ZINC to still be seen whilst offering the designer the choice of colour to complement other elements of a building's facade or roof.

The colouration of the zinc is achieved with a special pigment layer that enhances the qualities of the zinc without presenting a block colour. This product is tested to EN13523-10/2010 for UV-humidity and EN 15523-3/2001 for colour stability and requires minimum maintenance.

PIGMENTO provides a special resilience in a marine environment and makes the removal of salt deposits easier than on the regular surfaces of other zinc finishes.

PIGMENTO is available in four standard colours: PIGMENTO Blue, Green, Brown, and Red.

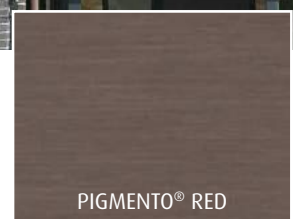
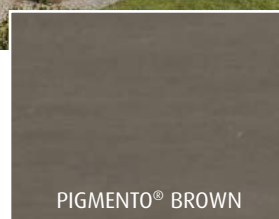

VMZ Standing seam

Richard Adams Architects



VMZ Standing seam



Warm roofs (non-ventilated)

Introduction

Typical detail using the VMZINC G3 Ridge on a warm non-vented build-up

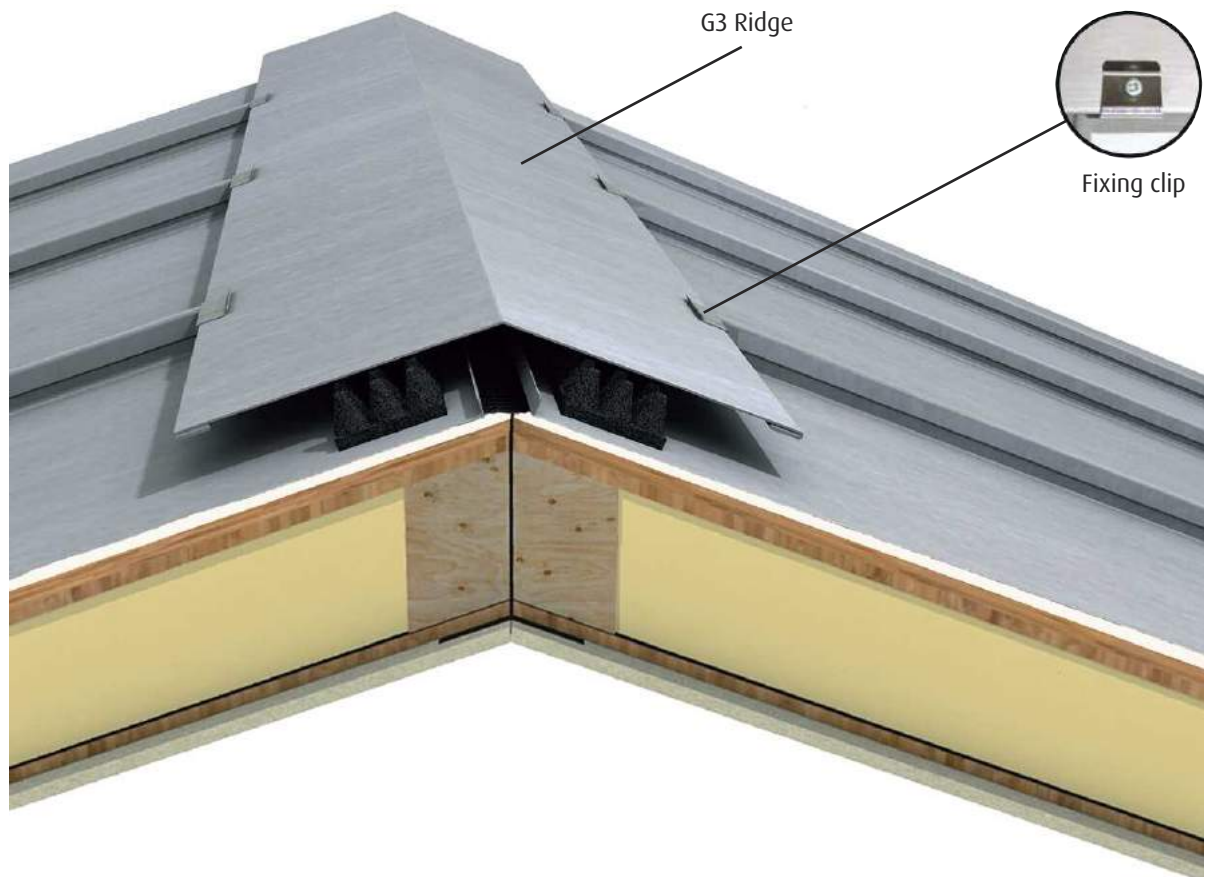

The VMZINC G3 Ridge:

- Gives a sleek, aesthetic value to the roof
- Is a standard VMZINC solution
- Is easy to install

VMZINC PLUS VMZINC PLUS must be used in all types of warm non-vented roof construction.

VMZINC PLUS is a unique solution that offers a protective coating 60 microns thick on its underside to protect the zinc from possible corrosion. VMZINC PLUS also allows all 7 available finishes to be installed.

Advantages of a warm non-vented roof This type of construction reduces thermal bridges and increases air tightness whilst still offering BBA certification and a BRE Green Guide rating.



For more information contact us on
01992 822288
or send an e-mail to
vmzinc.uk@umicore.com

Warm roofs (non-ventilated)

Introduction

Typical warm roof arrangement

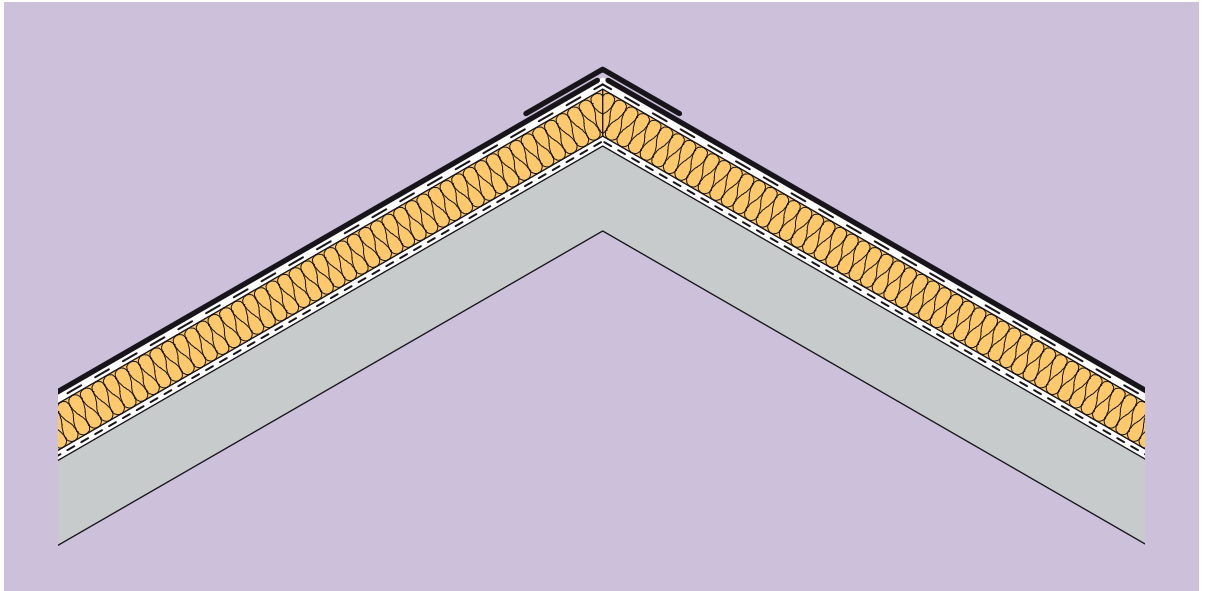

Continuous layer of insulation covering a fully supported vapour barrier.

Definition of warm roof in the UK

Warm non-ventilated and cold ventilated roofs are two terms which do not always denote the same ideas to all building professionals. In order to put the warm non-ventilated roof system into context, we will refer to it as a roof where there is absolutely no vented space within the roof build-up and furthermore the entire roof structure is on the warm side of the insulation. In the UK this means that the roof structure is entirely below the insulation.

Elements of the system

- VMZINC PLUS must be used on all warm roof build-ups
- VMZINC Membrane must be used (breather membrane)
- The substrate must be continuous and even and the correct fixing clips must be used
- A fully supported continuous vapour barrier must be installed (bitumen-backed aluminium foil). Polythene films are not acceptable

Warm roof standing seam constructions

With rigid insulation – Structural Roof	p14
With cellular glass insulation – Compact Roof	p16
With insulated metal-faced panels	p18
With plywood bonded to phenolic foam	p20



Standing seam on rigid insulation – Structural Roof

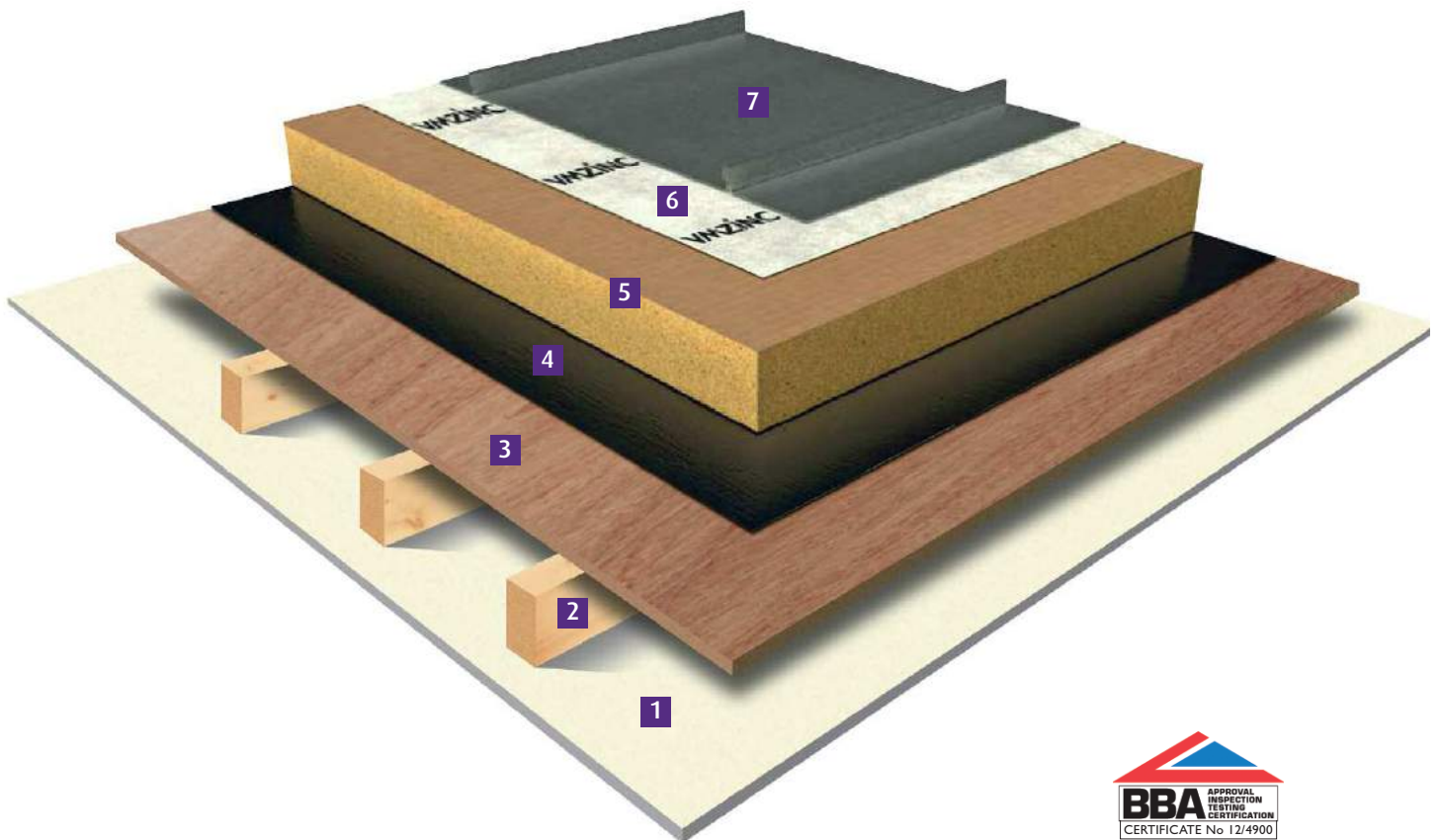

- Key to construction build-up**
- 1 Interior finish
 - 2 Rafters
 - 3 Continuous support (e.g. steel deck or plywood)
 - 4 Continuous, fully supported aluminium foil, bitumen-backed vapour barrier
 - 5 Insulation (e.g. mineral board or PIR)
 - 6 VMZINC Membrane
 - 7 VMZINC PLUS Standing Seam

- Advantages of the Structural Roof**
- BBA certified – 12/4900 product sheet 1
 - BRE Green Guide rated A+
 - Reduced thermal bridges



Example of bituminous vapour barrier with aluminium foil

Standing seam on rigid insulation – Structural Roof

Area of application

With this warm roof system VMZINC PLUS Standing Seam can be installed on rigid insulation (mineral board or PIR) without ventilating the underside of the zinc. It is fixed through to the deck with special fixing screws and clips supplied by VMZINC. The system can be used for roofs with a pitch from 3° to 70° and for buildings with humidity classes of between 1 to 4 (dwellings with high occupancy, sport halls, etc).

Structure

The supporting structure can be a steel or plywood deck. Either deck is covered by an aluminium foil-reinforced bituminous vapour barrier with a high water vapour resistance (minimum vapour resistance 4000MNsg) installed with cold or hot glued joints. Higher performance vapour barriers may be required depending on the humidity class of the building. All insulation materials must have a compression strength of minimum 50kPa (0.5kg/cm²), at a maximum 10% deformation and must be dimensionally stable at up to 100°C and comply with current Building Regulations. Between the VMZINC PLUS and the insulation, a VMZINC Membrane is fixed with an overlap that varies depending on the slope. The insulation material must also comply with the fire resistance requirements of the Building Regulations.

Clip types and associated components

The Structural Roof includes fixing systems that allow both fixed and sliding clips to be installed without damaging the insulation but at the same time allowing the zinc panels to freely expand and contract.

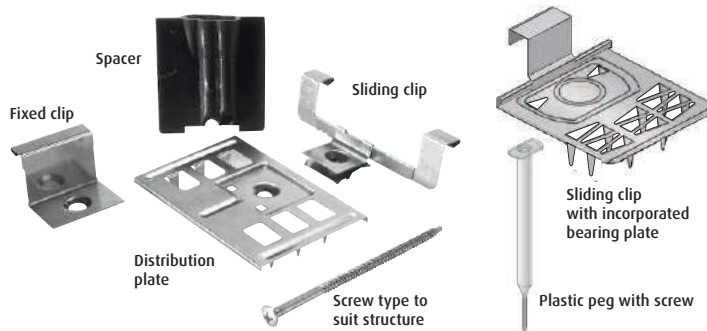

Note:
The information relating to the installation of insulation and membranes is indicative only.

The choice and installation of these products will be according to the recommendations of the insulation and membrane manufacturers.

Download the technical drawings of this roof build-up from our website
www.vmzinc.co.uk

Standing seam on cellular glass insulation – Compact Roof

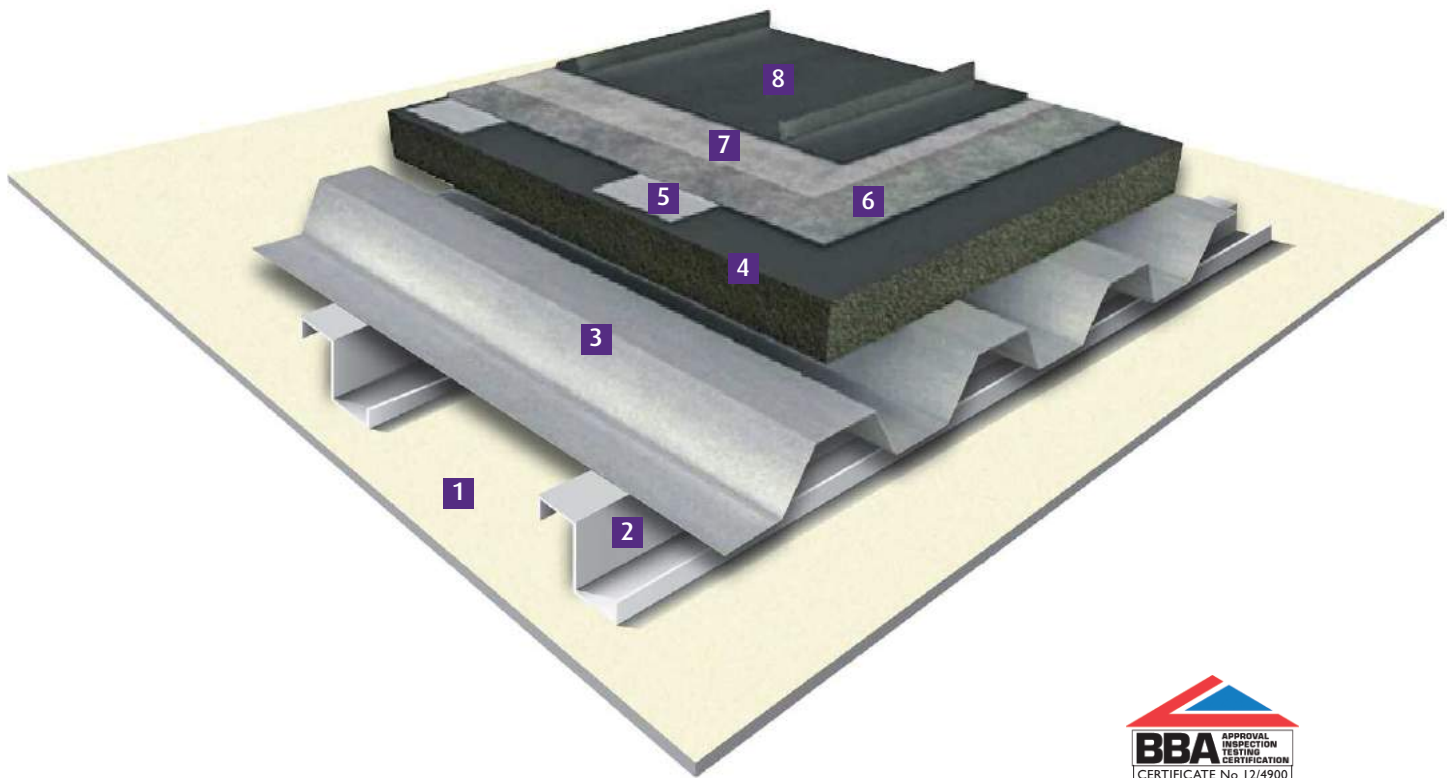

Key to construction build-up

- 1** Interior finish
- 2** Metal purlins
- 3** Continuous support (e.g. steel deck or plywood)
- 4** Cellular glass insulation (e.g. FOAMGLAS)
- 5** Galvanised steel plates
- 6** Bituminous membrane
- 7** Polyethylene separation layer
- 8** VMZINC PLUS Standing Seam

Advantages of the Compact Roof

- Ideal for buildings with high humidity levels (including class 5, swimming pools)
- BBA certified – 12/4900 sheet 2
- Almost no thermal bridges
- Excellent pull-out resistance



Galvanised steel plates inserted into FOAMGLAS insulation

Standing seam on cellular glass insulation – Compact Roof

Area of application Suitable for use on roofs with pitches from 3° to 60°. The only solution for high humidity buildings (eg swimming pools), this system can be installed on plywood and steel decks to the manufacturer's specifications.

FOAMGLAS cellular glass insulation offers resistance in any type of humid situations. Tapered or uniform thickness cellular glass insulation is available in board or slab format. Double layering is possible. For further information on cellular glass insulation, please contact FOAMGLAS.

Structure FOAMGLAS cellular glass insulation is adhered to the substrate using a cold adhesive; the staggered joints of the board are closely butted with the cold adhesive ensuring a vapour tight seal (no vapour barrier is required).

- The upper face of the cellular glass board has a bitumen and polyethylene protective layer.
- Galvanised steel plates are applied to the upper slab or board surface of the FOAMGLAS. Its bitumen upper surface is heated with a gas torch and the plates are inserted within the cellular glass insulation, forming a secure 'non thermal bridge' bond. The galvanised steel plates must be positioned in collaboration with the VMZINC installer.
- A high performance bituminous membrane +3mm thick with a sanded finish is torch applied to the upper surface of the insulation with lapped joints, the flow of bitumen ensures the butted joints are sealed. This membrane covers the entire roof surface including the plates.
- Polyethylene film is installed to avoid any contact between the VMZINC PLUS and the sanded torch-on bituminous membrane.
- The VMZINC PLUS panels are fixed to this structure with VMZINC clips screwed into the galvanised steel plates.



Note:
The information relating to the installation of insulation and membranes is indicative only.

The choice and installation of these products will be according to the recommendations of the insulation and membrane manufacturers.

Download the technical drawings of this roof build-up from our website
www.vmzinc.co.uk

Standing seam on insulated metal-faced panels

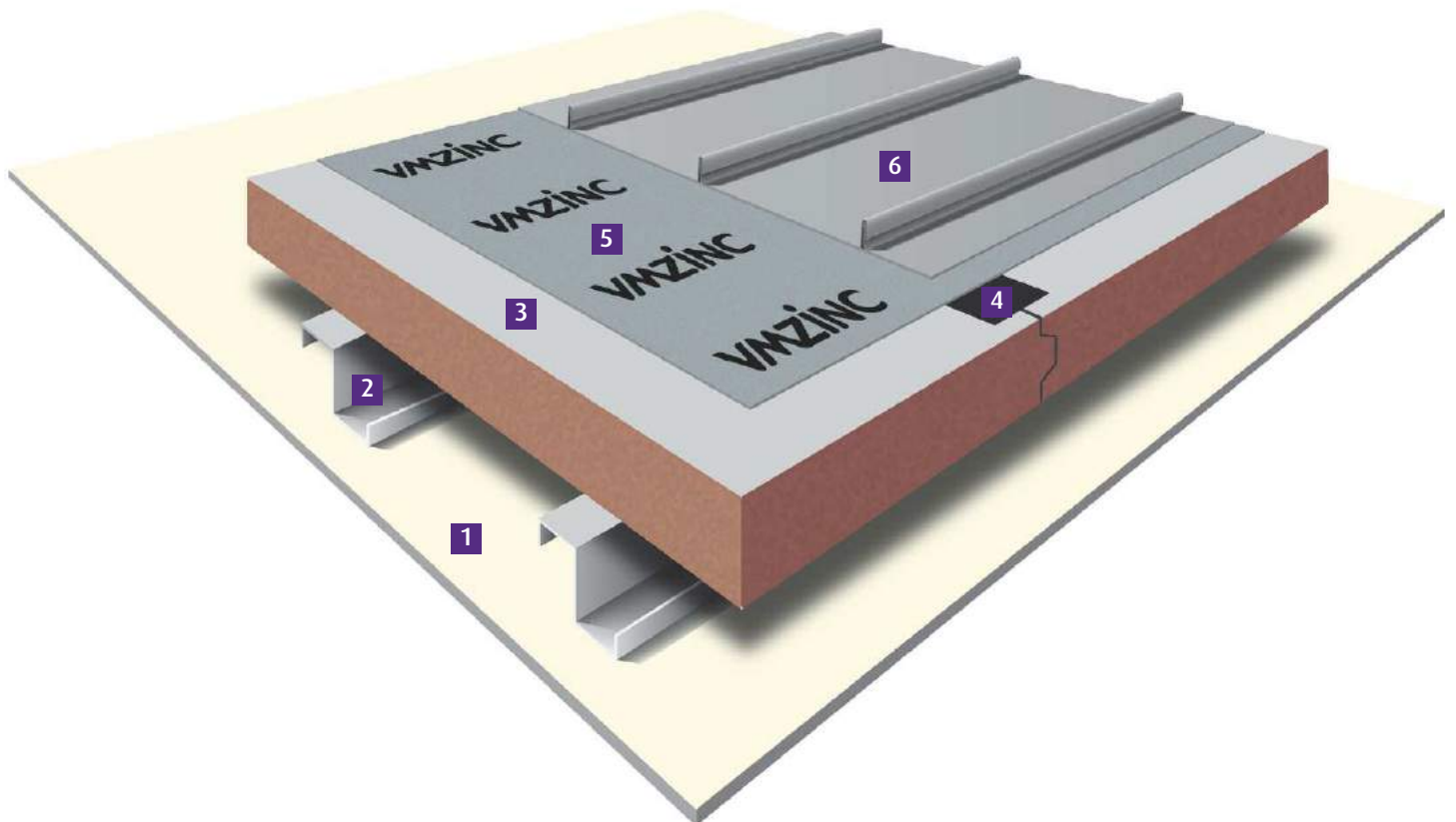

Key to construction build-up

- 1 Interior finish
- 2 Steel purlins
- 3 Insulated metal-faced panel (0.7mm steel thickness)
- 4 Aluminium-faced tape
- 5 VMZINC Membrane
- 6 VMZINC PLUS Standing Seam

Advantages of standing seam on insulated metal-faced panels

- BRE Green Guide rated A
- This solution provides good pull-out resistance
- Offers a fast track installation process over large areas
- Reduced thermal bridges
- Allows building to dry out rapidly



Standing seam on insulated metal-faced panels

Area of application Suitable for buildings in 1 to 4 humidity classes (dwellings with high occupancy, sports halls, etc) and with pitches from 3° to 70°. For installation on metal-faced composite panels VMZINC PLUS, with its specially protected underside, must be used. The outer skin must provide a minimum pull-out value of 50kN for the standing seam fixing clip (dynamic testing method).

Structure The insulated metal-faced composite panel must be made from galvanised steel on both the internal and external facing (minimum thickness 0.7mm for external facing). Fixings and clips must not inhibit the required expansion and contraction of the VMZINC PLUS or cause any damage to the protective coating underneath.

The insulated metal-faced composite panel must provide a 100% vapour barrier. This is normally achieved using a panel with a vapour tight interlocking jointing system. It is the specifier's responsibility to ensure there is no risk of condensation in this type of roof construction and the use and humidity of the building should be considered before specifying this solution.

The warm side of the insulated panel joint must be sealed together with the top side. All joints and penetrations should be sealed appropriately.

The surface of the support that the zinc is to be laid on, must be even to within 2mm.

Clips and screws

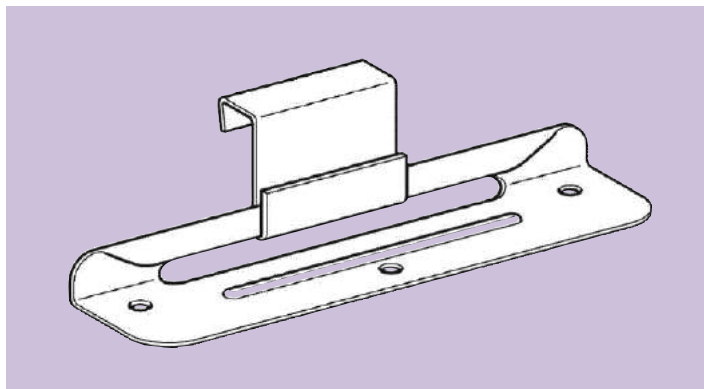

It is important that all screws and clips used on an insulated metal panel must be flush to the surface of the panel within 2mm. For instances where this is not the case it is possible to use clips with a raised section that allows free thermal expansion and contraction of the zinc panel without any risk to the underside of the zinc.



Note:
The information relating to the installation of panel, clips and membranes is indicative only.

The choice and installation of these products will be according to the recommendations of the panel manufacturer.

Download the technical drawings of this roof build-up from our website
www.vmzinc.co.uk

Standing seam on plywood bonded to phenolic foam

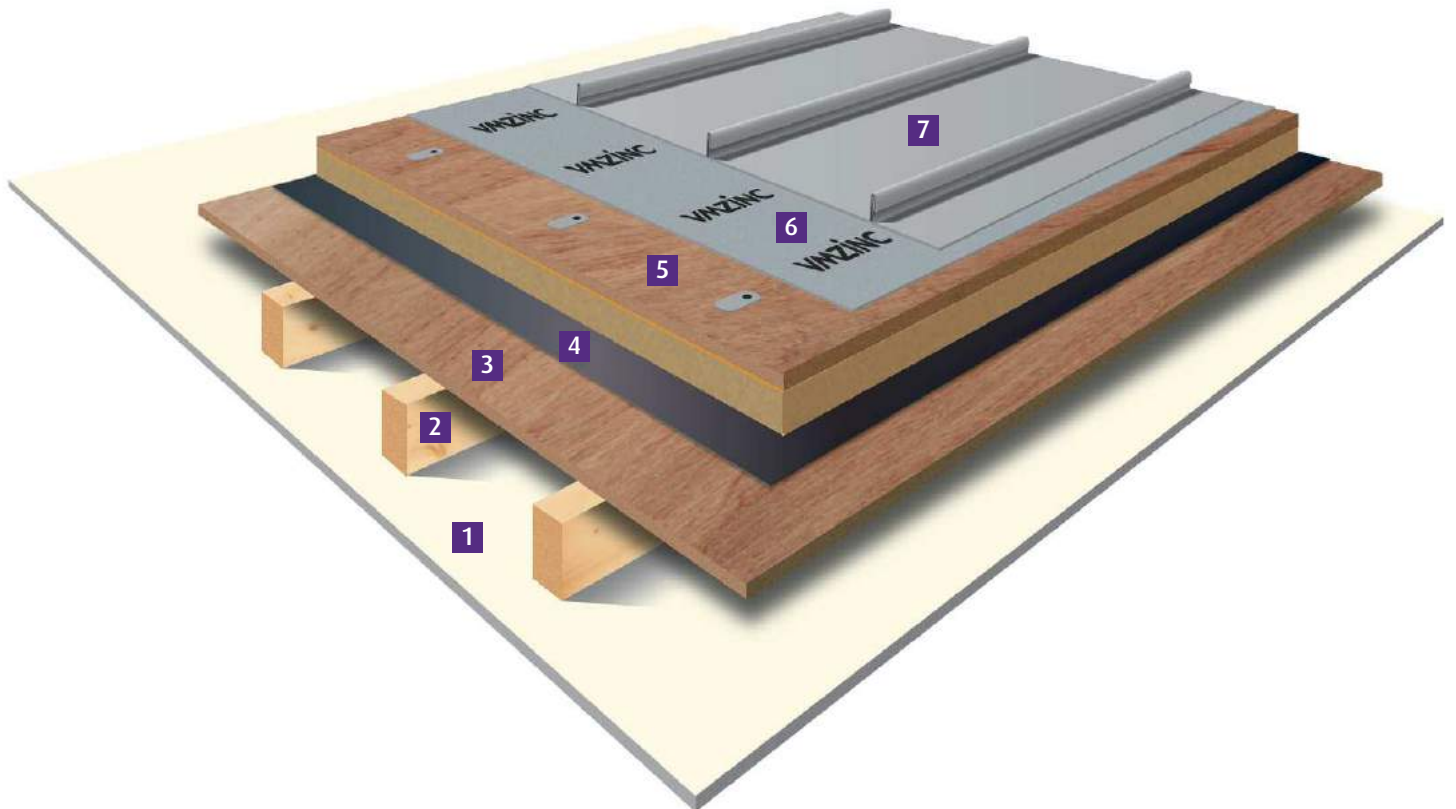

Key to construction build-up

- 1** Interior finish
- 2** Rafters
- 3** Continuous support (e.g. steel deck or plywood)
- 4** Continuous, fully supported aluminium foil, bitumen-backed vapour barrier
- 5** Metdeck panel (plywood bonded to phenolic insulation)
- 6** VMZINC Membrane
- 7** VMZINC PLUS Standing Seam

Advantages of standing seam on plywood bonded to phenolic foam

- Metdeck provides a continuous support to VMZINC PLUS
- Easy installation using traditional clips
- Reduces thermal bridging
- Timber substrate can resist limited foot traffic
- Minimises the number of fixings required
- Excellent pull-out resistance



Standing seam on plywood bonded to phenolic foam

Area of application

The system can be used for roofs with a pitch from 3° to 70° and for buildings with humidity classes of between 1 to 4 (dwellings with high occupancy, sport halls, etc). As with all warm (non-ventilated) roofs VMZINC PLUS must be used. This system provides a continuous 18mm WBP exterior grade plywood substrate allowing greater flexibility installing the VMZINC PLUS finish, thus eliminating the need to penetrate the insulation layer with additional fixings thereby minimising thermal bridging. With this warm roof system VMZINC PLUS Standing Seam can be installed on Metdeck composite panels without ventilating the underside of the VMZINC PLUS.

Structure

The substrate of the Metdeck composite panels (on the warm side of the roof panel) must be covered with a continuous aluminium foil-backed bituminous self-sealing vapour barrier to BS EN 13970: 2004.

Condensation risk must be assessed for each individual project or individual project component in accordance with BS 5250: 2002. Specification may need to be adapted to the internal humidity load of the building. The VMZINC Membrane should be installed between the VMZINC PLUS and the Metdeck composite panels, then dressed into the gutter.

Metdeck composite panels, incorporating 18mm WBP plywood factory-bonded to a Resol insulation core, are mechanically fixed to the substrate (vapour barrier on concrete, metal or timber deck). The number of fixings required will vary with specific building details and geographical location, and must be assessed on an individual basis.



Table of U-values

Product thickness* (mm)	U-value (W/m²K)
98	0.23
108	0.21
118	0.19
138	0.16
148	0.15

*Product thickness = insulation + 18mm WBP ply.

Note:
The information relating to the installation of insulation and membranes is indicative only.

The choice and installation of these products will be according to the recommendations of the insulation and membrane manufacturers.

Download the technical drawings of this roof build-up from our website
www.vmzinc.co.uk

VMZ Standing seam

Tim Ronalds Architects

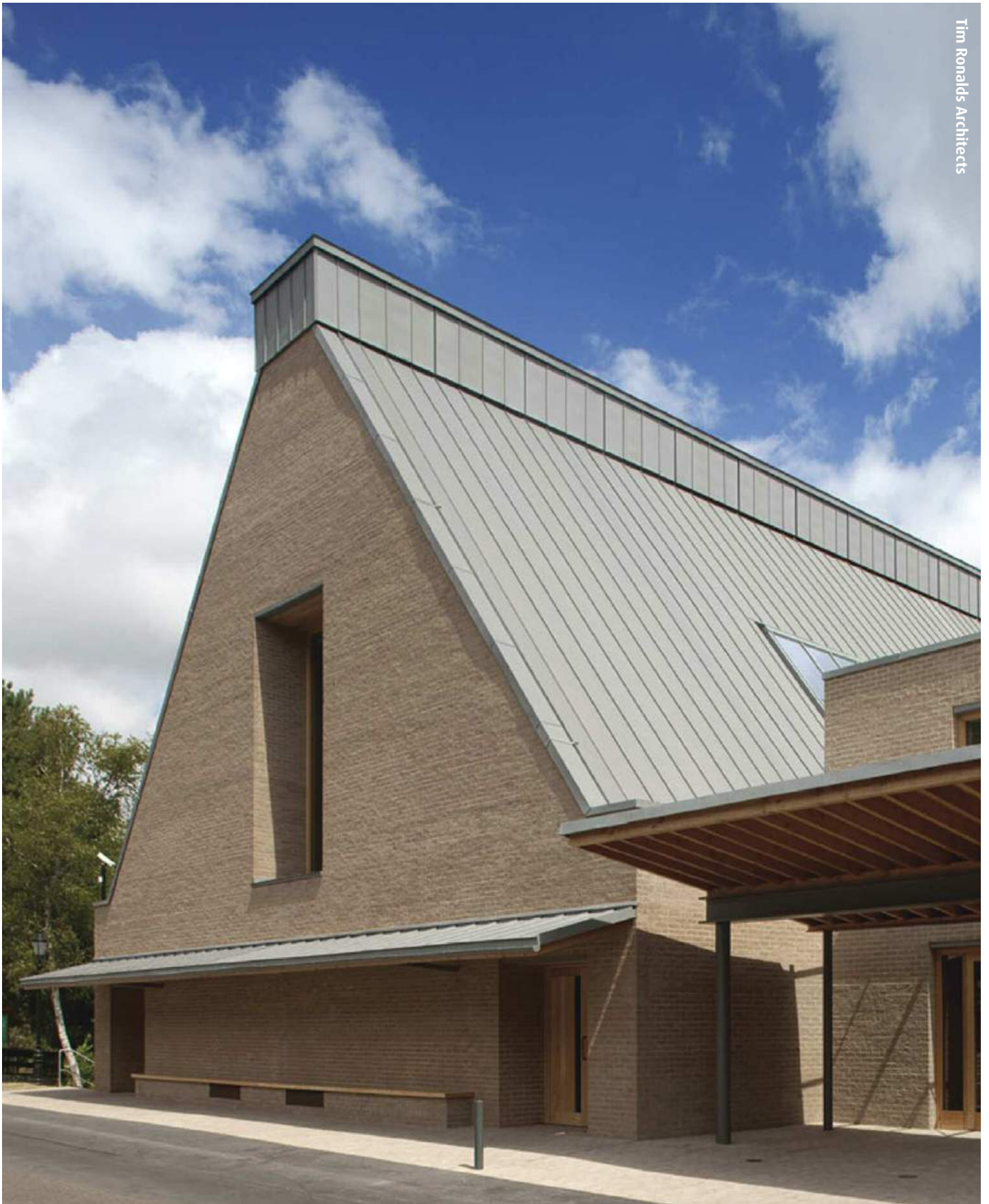

VMZ Standing seam



Iyack Architects Ltd



DRRW Architect, France

Cold roofs (ventilated)

Introduction

Typical ridge detail

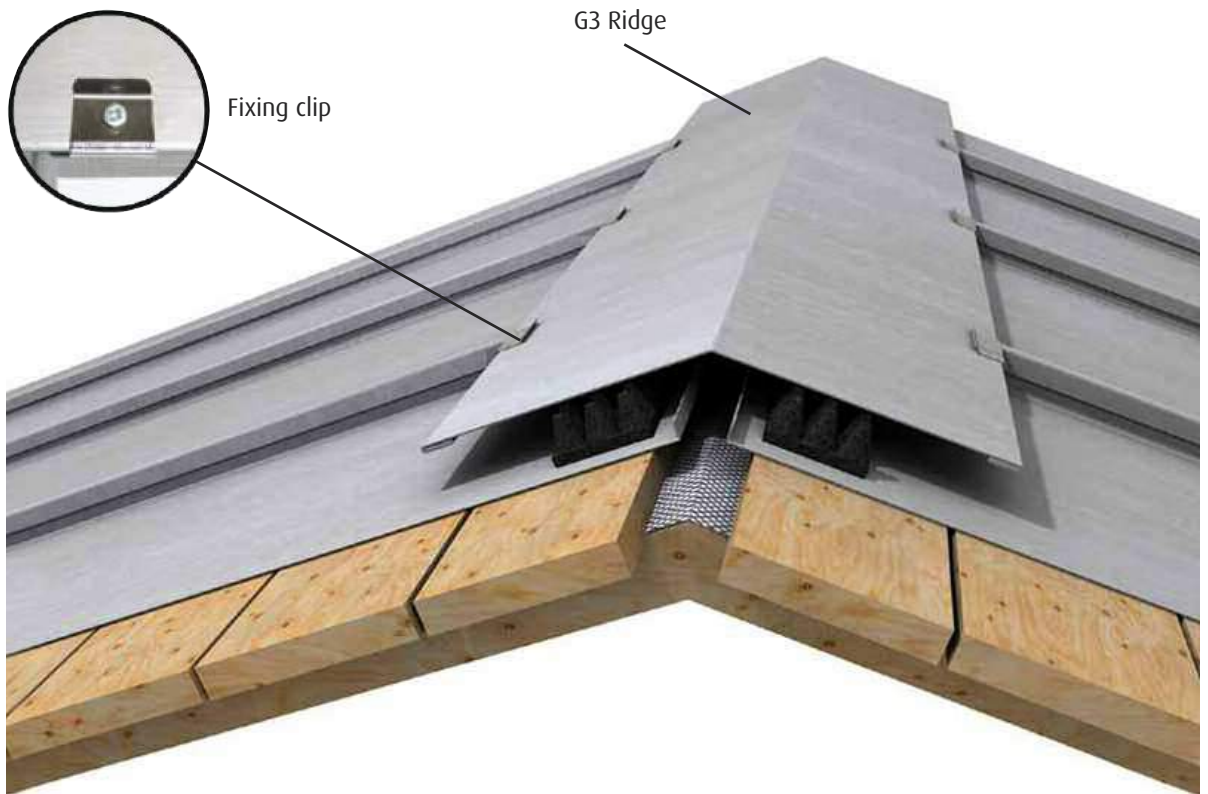

The VMZINC G3 Ridge, shown above:

- Gives a sleek, aesthetic value to the roof
- Is a standard VMZINC solution
- Is easy to install

VMZINC PLUS VMZINC PLUS is a unique solution that offers a protective coating 60 microns thick on its underside to protect the zinc from possible corrosion. VMZINC PLUS allows zinc in all 8 available finishes to be installed on a cold vented roof using a plywood deck (page 26).

Advantages of a cold vented roof Traditional construction which has a long history and is covered by the Code of Practice 143-5: 1964. This type of build up can be used on roofs ranging from 3° to vertical as well as soffits.

Alternative ridge detail



For more information contact us on
044 1992 822288
or send an e-mail to
vmzinc.uk@umicore.com

Cold roofs (ventilated)

Introduction

Typical cold roof arrangements

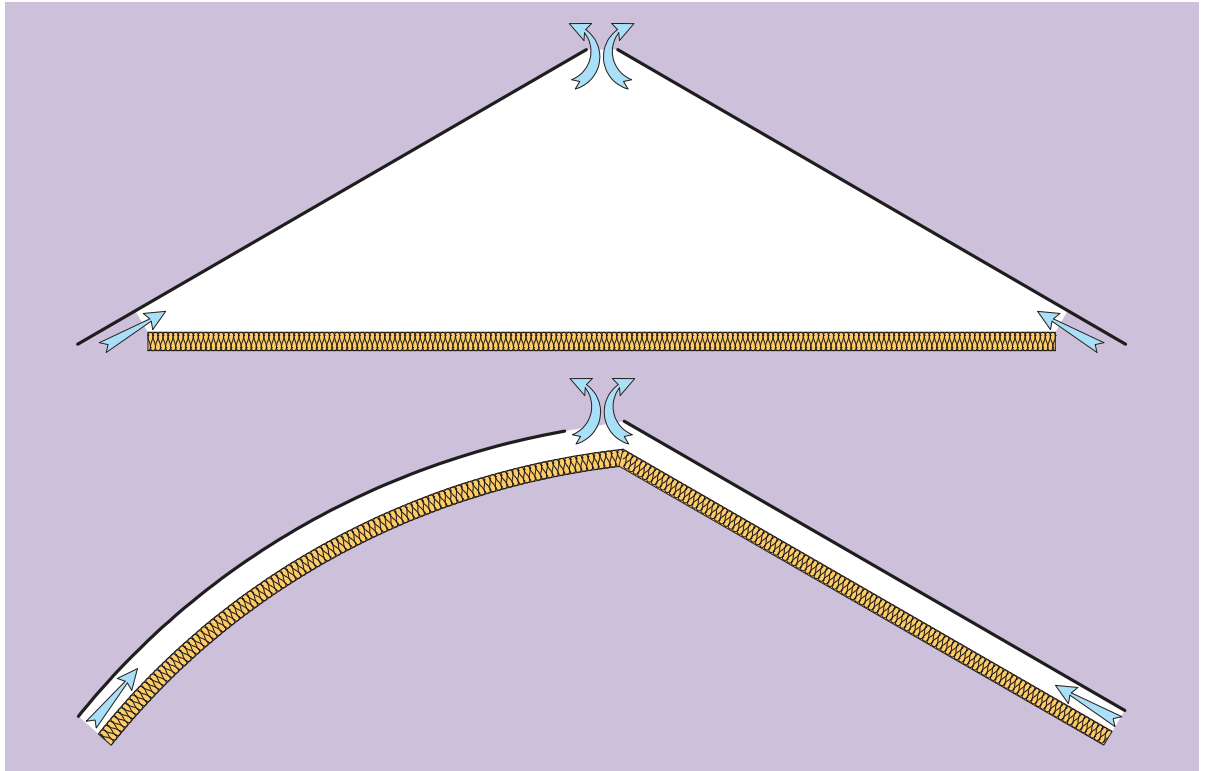

Air inlets and outlets are generally linear (at least 10mm wide) but can be individual (see photo). The ventilation must correspond to BS 5250: 2002.

Definition of cold roof in the UK

Cold ventilated roofs and warm non-ventilated roofs are two terms which do not always denote the same ideas to all building professionals. In order to put the cold ventilated roof system into context, we will refer to it as a roof where there is a continuous air space of at least 50mm between the substrate supporting the zinc and the insulation. This air space must be a vented space with openings generally at the eaves and the ridge. Linear air vents must be at least 10mm wide and are commonly protected by insect mesh. It is always good practice to include a vapour control layer in the build up and this should be installed on the warm side of the insulation.

Elements of the system

- VMZINC PLUS must be used on plywood whereas VMZINC is acceptable on open-gap softwood boards (see page 28)
- VMZINC Membrane can be used to protect the insulation
- The substrate must be continuous and even, and the correct fixing clips must be used



Cold roof standing seam constructions

With plywood	p26
With open-gap timber boarding	p28

Standing seam on vented plywood

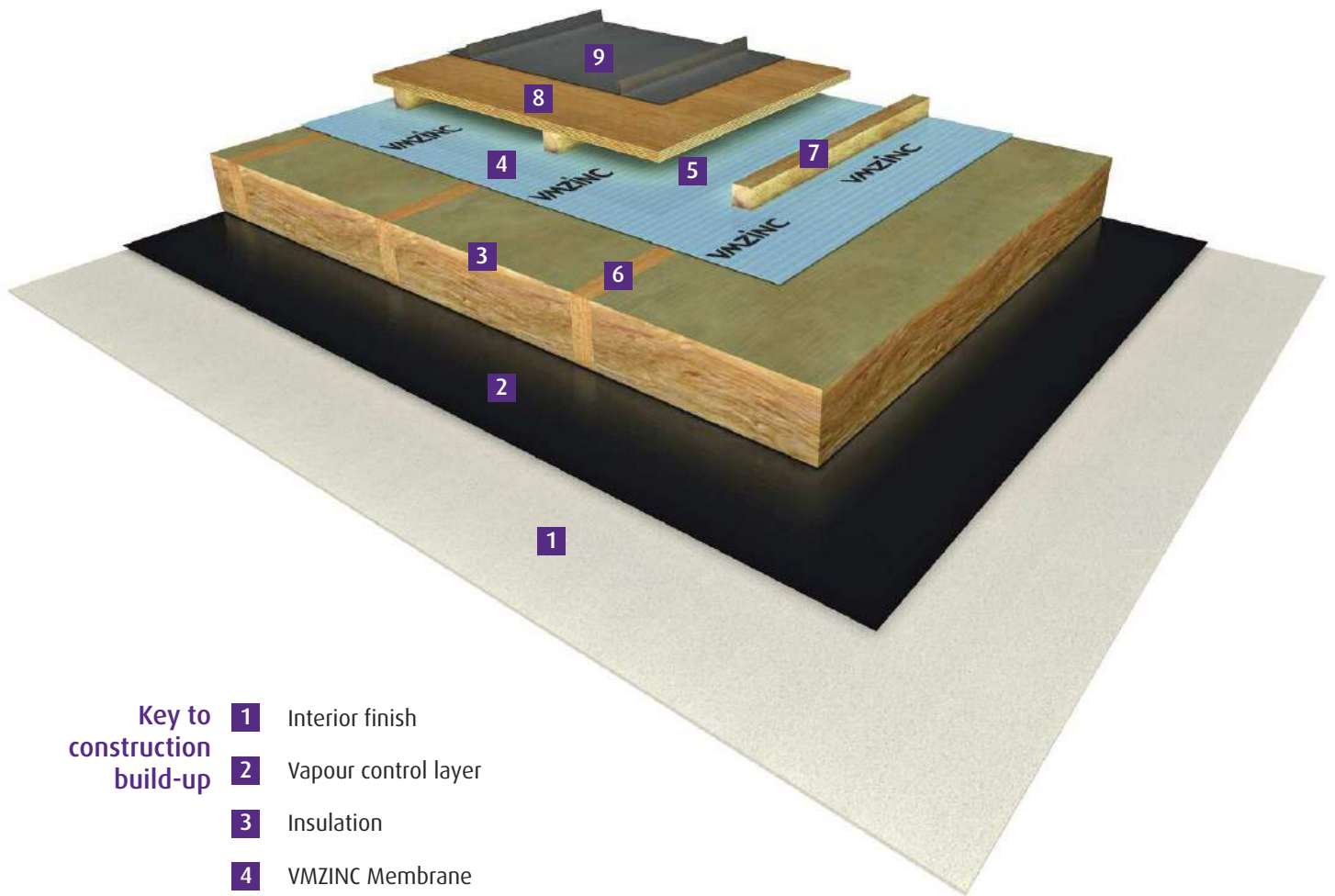

Key to construction build-up

- 1** Interior finish
- 2** Vapour control layer
- 3** Insulation
- 4** VMZINC Membrane
- 5** 50mm ventilated air space (minimum)
- 6** Rafter
- 7** Batten
- 8** Plywood
- 9** VMZINC PLUS Standing Seam

Advantages of standing seam on vented plywood

- Provides a continuous rigid deck for the VMZINC PLUS
- Plywood decking is readily available and widely used
- Excellent pull-out resistance
- BRE Green Guide rated A+



Standing seam on vented plywood

Area of application Suitable for buildings in 1 to 4 humidity classes (dwellings with high occupancy, sport halls, etc) with pitches from 3° to the vertical. VMZINC is installed on the roof boarding. A 50mm continuous air gap must be left clear beneath the plywood. Continuous ventilation openings are made at the ridge and eaves. In order to maintain the integrity of the roof, a breather membrane should be installed on the cold side of the insulation, and a vapour control layer appropriate to the building's humidity levels laid on the warm side of the insulation.

Structure VMZINC PLUS must be used. VMZINC Membrane can be used between the VMZINC PLUS and the plywood, although this is optional but may have the advantage of protecting the plywood prior to the installation of the zinc. The ideal thickness of the plywood is 18mm and it must be weather and boil proof. WBP plywood is more precisely described as EN314-3 (glue bond) and EN636-2 (timber performance). The substrate must be flush to within 2mm and all screws and nails must be countersunk. The 50mm air space must be continuous and vented by openings at the base and top of the roof which are generally linear vents at least 10mm wide protected by insect mesh and correspond to BS 5250: 2002. The VMZINC membrane can be used to protect the insulation but the 50mm air space must not be compromised. It is also recommended to install a vapour control layer on the warm side of the insulation.



Note:
The information relating to the installation of insulation and membranes is indicative only.

The choice and installation of these products will be according to the recommendations of the insulation and membrane manufacturers.

Download the technical drawings of this roof build-up from our website
www.vmzinc.co.uk

Standing seam on open-gap timber boarding

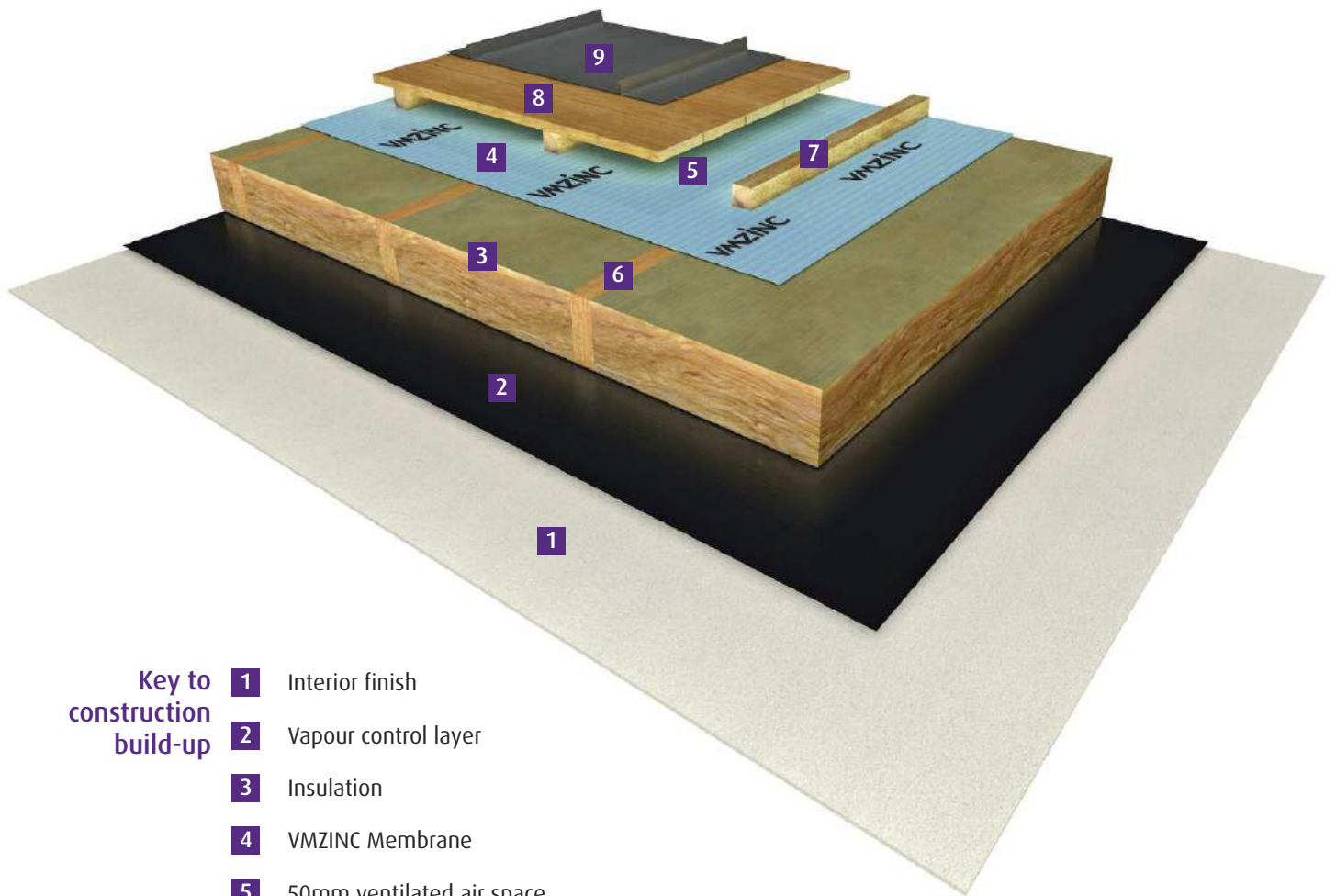

Key to construction build-up

- 1 Interior finish
- 2 Vapour control layer
- 3 Insulation
- 4 VMZINC Membrane
- 5 50mm ventilated air space
- 6 Rafter
- 7 Batten
- 8 Open-gap timber boarding
- 9 VMZ Standing Seam

Advantages of standing seam on open-gap timber boarding

- A very versatile and easy to install substrate
- Flexible because it also permits complex shapes to be clad in zinc
- Excellent pull-out resistance
- Easy installation using traditional clips
- BRE Green Guide rated A+



Standing seam on open-gap timber boarding

Area of application Suitable for buildings in 1 to 4 humidity classes (dwellings with high occupancy, sport halls, etc) with pitches from 3° to the vertical (as well as soffits). VMZINC is installed on the roof boarding. A 50mm continuous air gap must be left clear beneath the roof boarding. Continuous ventilation openings are made at the ridge and eaves. In order to maintain the integrity of the roof, a VMZINC breather membrane should be installed on the cold side of the insulation, and a vapour control layer appropriate to the building's humidity levels laid on the warm side of the insulation.

Structure VMZINC must be installed directly over the open-gap softwood boarding without the use of any membrane. The boarding should be clean and dry, 100mm to 150mm wide, 18mm or 24mm thick, according to the rafter centres. Any wood treatment products (fungicides, insecticides) must be dry and completely neutral in relation to VMZINC. See page 36.

The roof boards are fixed perpendicularly to the direction of the pitch leaving a 3mm to 5mm gap between them. They are securely fixed to the structure.

Maximum difference in height between roof boards should not be more than 1mm. The deflection measured under a rigid 600mm long straight edge cannot exceed 2mm in any direction. The roof board nails are countersunk in order to avoid any contact with the VMZINC.

Metal salt solutions must not be used on the timber boarding.



Note:
The information relating to the installation of insulation and membranes is indicative only.

The choice and installation of these products will be according to the recommendations of the insulation and membrane manufacturers.

Download the technical drawings of this roof build-up from our website
www.vmzinc.co.uk

VMZ Standing seam



Once Architecture

VMZ Standing seam



David Morley Architects



Lancashire County Council

Technical drawings

Download the complete set of technical drawings from our website www.vMZinc.co.uk

Ridge detail

The ridge detail uses Standing Seam on rigid insulation - Structural Roof construction (p14)

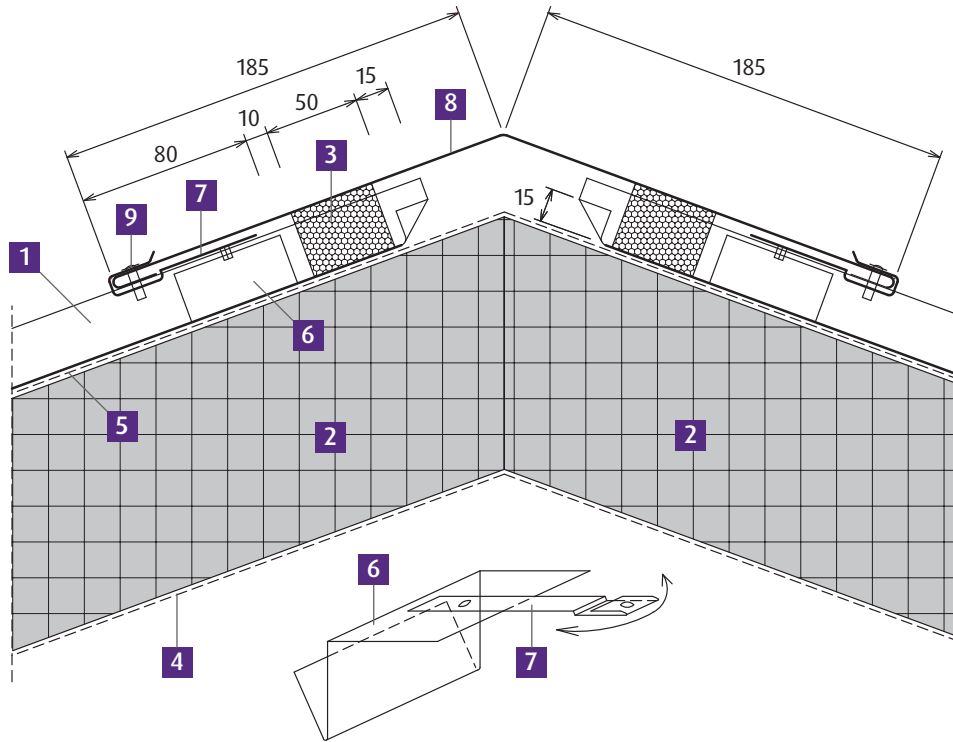

- 1 VMZINC PLUS Standing Seam
- 2 Insulation: mineral wool or PIR
- 3 Decompression strip G3
- 4 Vapour barrier: aluminium foil/bitumen type fully supported by plywood or metal deck
- 5 VMZINC Membrane
- 6 VMZINC Ridge Clip G3 (fixed part)
- 7 VMZINC Ridge Clip G3 (moving part)
- 8 VMZINC Ridge G3
- 9 Clip fixing in accordance with the specification

Box gutter (inside wall) detail

The box gutter detail uses Standing Seam on cellular glass insulation - Compact Roof construction (p16)

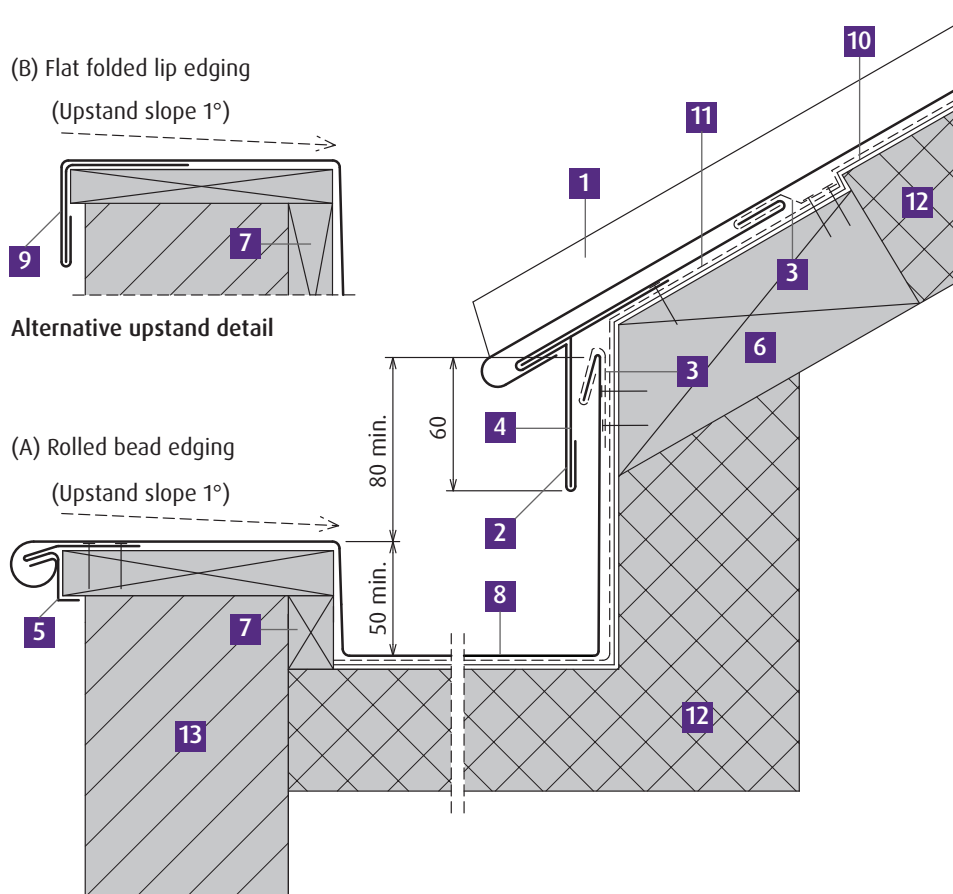

- 1 VMZINC PLUS Standing Seam
- 2 VMZINC PLUS continuous eaves apron strip
- 3 VMZINC PLUS sheet clip, 0.7mm thick, width 80mm, 2 per m
- 4 VMZINC PLUS continuous folded strip, 0.7mm thick
- 5 VMZINC PLUS continuous apron strip, 0.7mm thick
- 6 Timber blocking, 5mm thinner than the insulation
- 7 Roof boarding
- 8 VMZINC PLUS boxed gutter
- 9 VMZINC PLUS continuous sheet strip, 0.7mm thick
- 10 Roofing membrane in accordance with the specification
- 11 PE film
- 12 Cellular glass insulation
- 13 Wall

All dimensions in mm

Technical drawings

Download the complete set of technical drawings from our website www.vmzinc.co.uk

Verge detail

The verge detail uses Standing Seam on insulated metal-faced panels construction (p18)

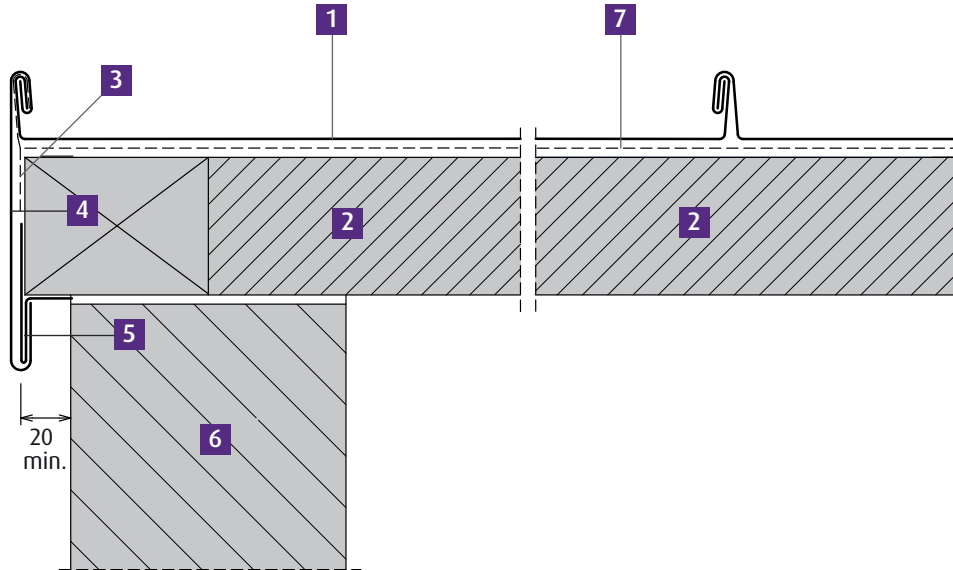

- 1 VMZINC PLUS Standing Seam
- 2 Insulated metal-faced panel in accordance with the specification
- 3 VMZ stainless steel sliding clip, bent to shape as required
- 4 VMZINC PLUS fascia
- 5 VMZINC PLUS continuous edge flashing
- 6 Wall
- 7 VMZINC Membrane

Box gutter (outside wall) detail

The box gutter detail uses Standing Seam on plywood bonded to phenolic foam construction (p20)

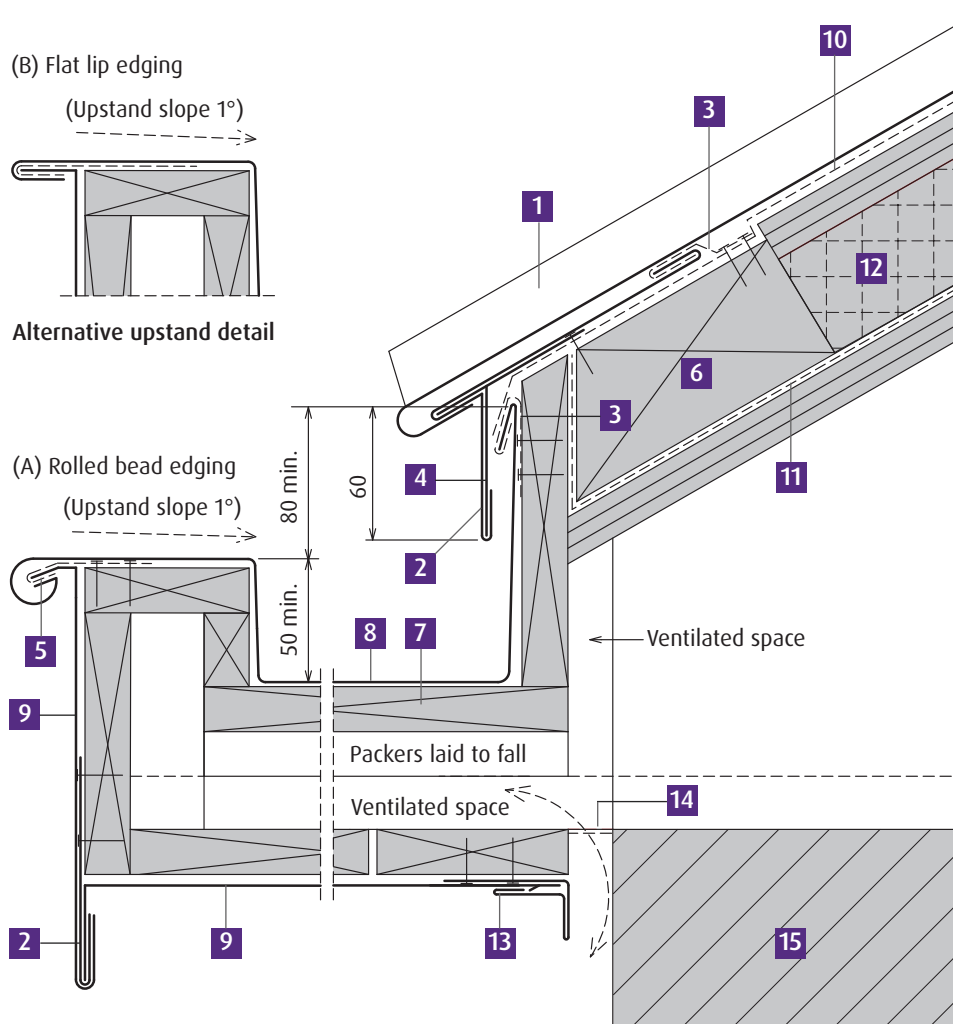

- 1 VMZINC PLUS Standing Seam
- 2 VMZINC PLUS continuous eaves apron strip
- 3 VMZINC PLUS sheet clip, 0.7mm thick, width 80mm, 2 per m
- 4 VMZINC PLUS continuous folded strip, 0.7mm thick
- 5 VMZINC bracket, 1mm thick, width 250mm, 2 per m
- 6 Timber blocking, 5mm thinner than Metdeck
- 7 Roof boarding (under box gutter on packers laid to fall)
- 8 VMZINC PLUS boxed gutter
- 9 VMZINC fascia with 400mm x 2000mm welted panels
- 10 VMZINC Membrane
- 11 Vapour barrier: aluminium foil/bitumen type fully supported on plywood or metal deck
- 12 Metdeck panel (plywood bonded to Resol phenolic foam)
- 13 VMZINC Uniprofil F4
- 14 Insect mesh
- 15 Wall

All dimensions in mm

Technical drawings

Download the complete set of technical drawings from our website www.vmzinc.co.uk

Rooflight detail

The rooflight detail uses Standing Seam on vented plywood construction (p26)

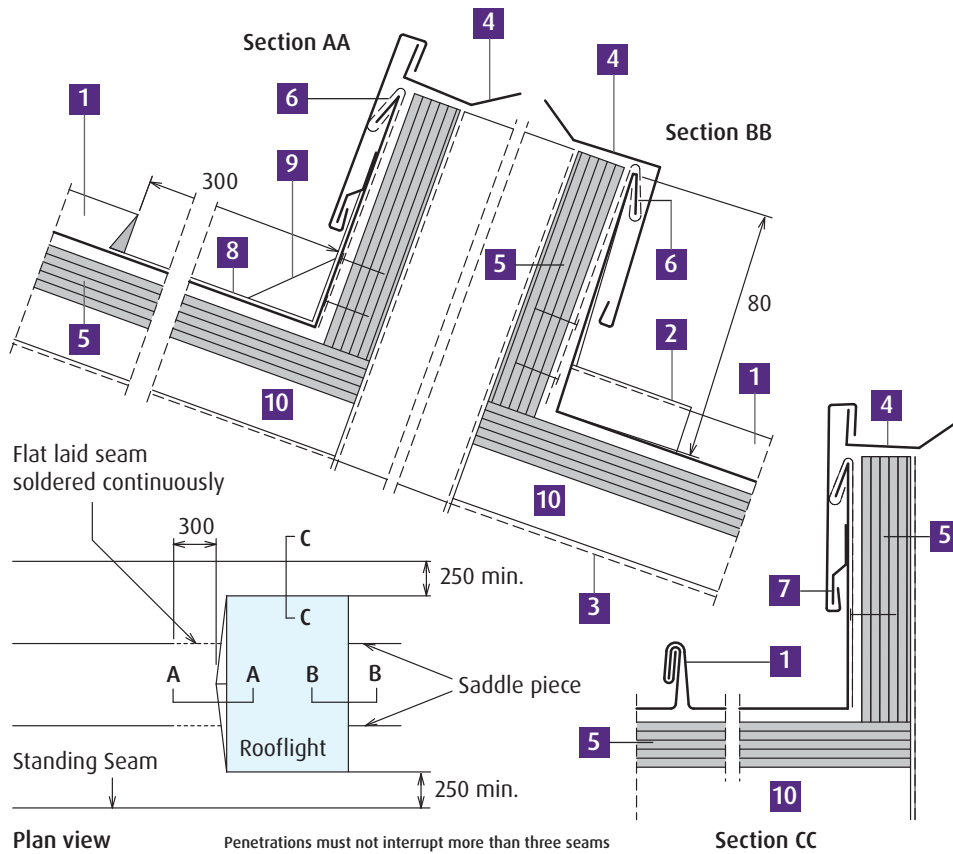

- 1 VMZINC PLUS Standing Seam
- 2 VMZINC head saddle piece
- 3 Breather membrane
- 4 Rooflight flashing
- 5 Plywood
- 6 VMZINC PLUS sheet clip, 0.7mm thick, width 80mm, 2 per m
- 7 VMZINC double welt, continuously soldered
- 8 VMZINC Standing Seam, folded, laid flat and soldered with space at fillet allowing expansion
- 9 Fillet, 0.5° minimum slope
- 10 Ventilated space

Mansard detail

The mansard detail uses Standing Seam on open-gap timber boarding construction (p28)

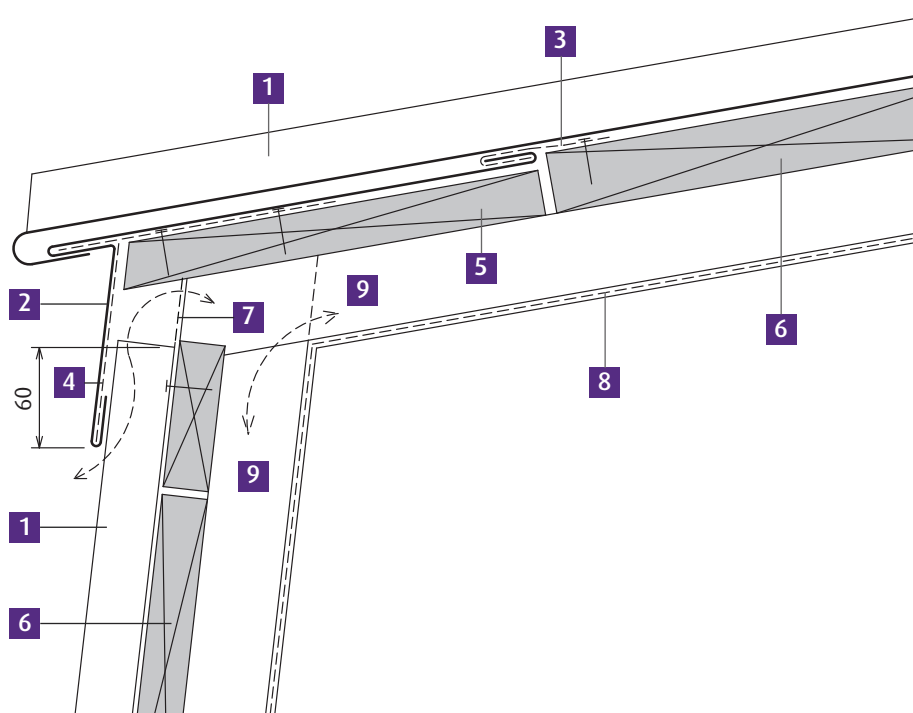

- 1 VMZ Standing Seam
- 2 VMZINC continuous eaves apron strip
- 3 VMZINC sheet clip, 0.8mm thick, width 80mm, 2 per m
- 4 VMZINC folded clip, 1mm thick, width 250mm, 2 per m
- 5 Eaves board, 5mm thinner than adjacent boards
- 6 Roof boarding
- 7 Insect mesh
- 8 VMZINC Membrane
- 9 Ventilated space

All dimensions in mm

Technical drawings

Download the complete set of technical drawings from our website www.vmzinc.co.uk

Ventilated ridge detail

The ventilated ridge detail uses Standing Seam on open-gap timber boarding construction (p28)

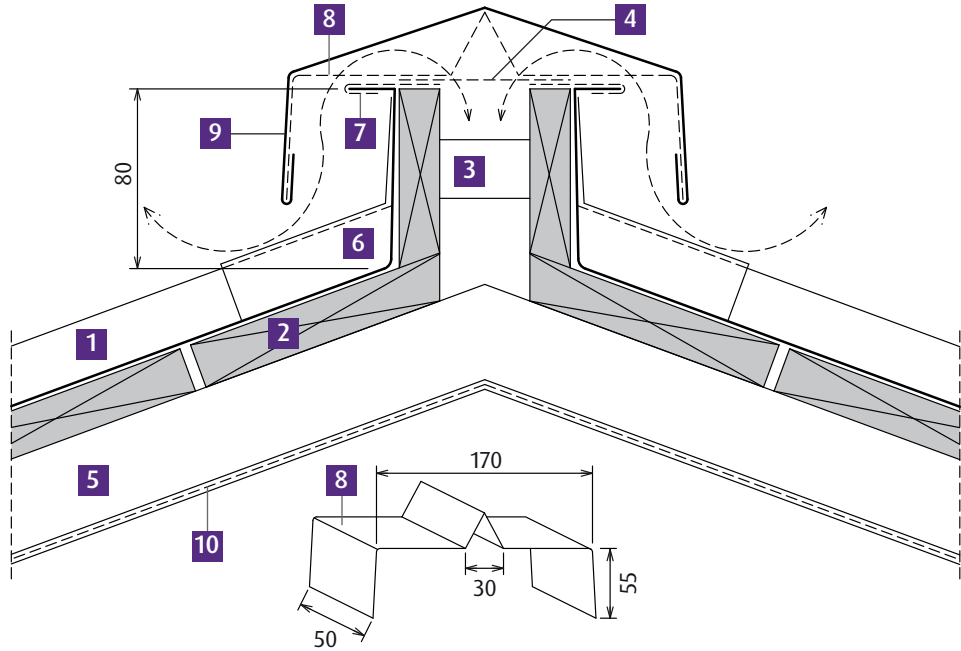

- 1 VMZ Standing Seam
- 2 Roof boarding
- 3 Sprocket piece
- 4 Insect mesh
- 5 Ventilated space
- 6 VMZINC saddle piece
- 7 VMZINC sheet clip, 0.8mm thick, width 80mm, 2 per m
- 8 VMZINC folded clip, 2 per m
- 9 VMZ ridge piece
- 10 VMZINC Membrane

Box valley gutter detail

The box valley gutter detail uses Standing Seam on vented plywood construction (p26)

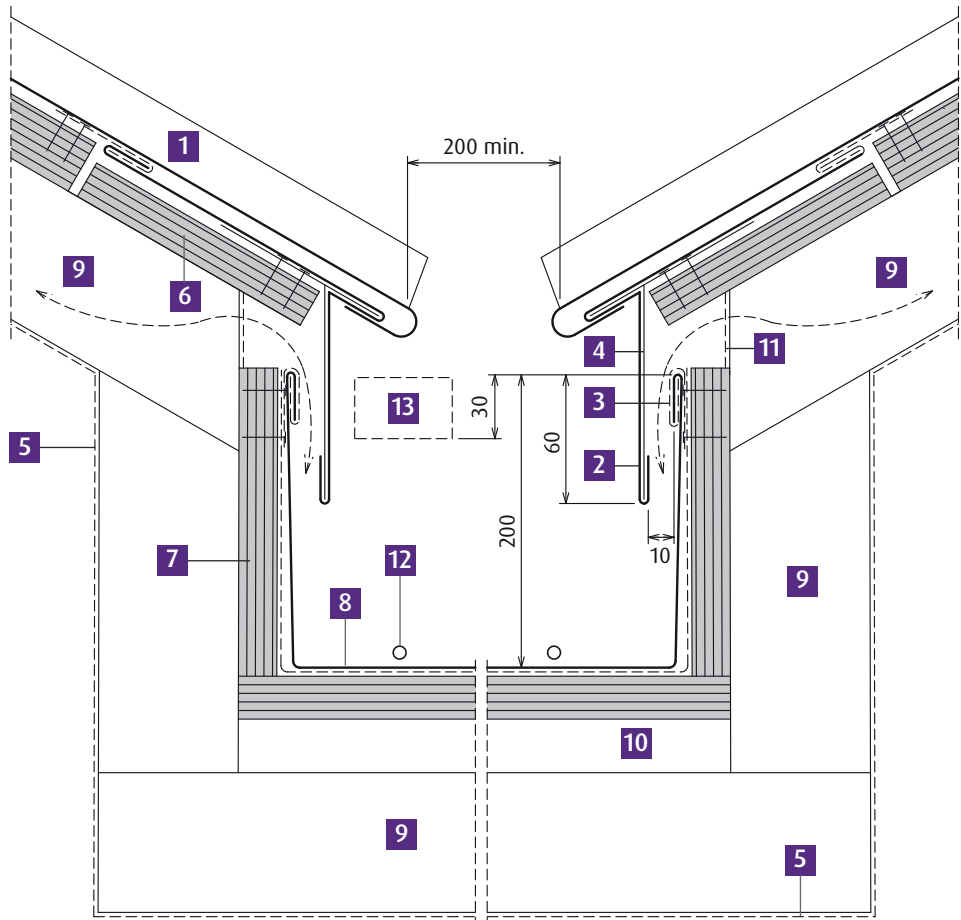

- 1 VMZINC PLUS Standing Seam
- 2 VMZINC PLUS continuous eaves apron strip
- 3 VMZINC PLUS sheet clip, 0.7mm thick, width 80mm, 2 per m
- 4 VMZINC PLUS continuous folded strip 0.7mm thick
- 5 Breather membrane in accordance with the specification
- 6 Plywood eaves strip, 5mm thinner than adjacent plywood
- 7 Plywood
- 8 VMZINC PLUS gutter lining
- 9 Ventilated space
- 10 Packers laid to gutter fall
- 11 Insect mesh
- 12 Heating cables (if required)
- 13 Overflow at stop end(s) of gutter

All dimensions in mm

VMZ Standing seam

Further technical information

Zinc aesthetics It is generally not recommended that zinc roofs and walls are cleaned as rain water performs this task very well. Non-rinsed surfaces such as soffits and some facades, especially in coastal areas may exhibit some stains. It should be noted that this is not a form of corrosion.

Zinc can be installed adjacent to limestone. The run off from limestone onto zinc material is acceptable. However, limestone dust and gypsum dust generated during cutting operations can react with zinc in the presence of water and form a superficial layer of white rust. No dust should be in contact with unprotected zinc. To prevent white rust, good construction practices should be used to limit the amount of dust that comes in contact with the zinc.

VMZINC manufacturing uses a colour management system based on the Y-Factor. The Y-factor ranges from 0 to 100: 0 is black and 100 is white. The range for ANTHRA-ZINC is 5 to 7 and the range for QUARTZ-ZINC is 22 to 25. We recommend that one project uses one production batch.

Fixing system method Clips have a dual function:

- Ensuring the mechanical resistance of the entire roof
- Allowing free expansion of the metal

VMZINC clips are made of 304 stainless steel. The thickness of the fixing clip is 0.5mm. The sliding clips have a moving component, which is 0.4mm thick, and a 70mm long slot to allow free movement of the panel when it is under expansion and contraction. Each clip must resist a pull-out force of 50daN. It is recommended that screws be used to secure the clips with three being used per sliding clip. The use of nails offers significantly less resistance, but in the event of using nails, contractors are advised to use ring shank nails.

Centre to centre distance between clips:

- 330mm on the main part of the roof
- 200mm on perimeter of the roof (at least 1100mm or 1/8 of the projected roof)
- 150mm in the corners



All standing seam panels require a minimum of 5 fixed clips. When attaching PV panels, snow guards, etc it may be necessary to further increase the number of these clips. Standard panel width is 600mm, however for aesthetic or wind up lift reasons 530mm or even 430mm wide panels can be used. Please consult us for further information.

VMZINC Membrane

VMZINC Membrane is a breather layer that allows water vapour to pass through it but is water proof to liquid water (up to a column of 2m). For roof pitches above 22° (40%) the membrane should be overlapped by 150mm. Below this slope the overlap should be increased to 200mm. For pitches between 3° (5%) and 14° (25%) the overlap should be 200mm and taped.

VMZINC in relation to other materials

Compatible contact products
Metals
Lead
Aluminium (painted, anodised or bare)
Galvanised steel
Stainless steel
Woods
Pine
Spruce
Scots pine
Poplar
Miscellaneous materials
Polyurethane
Non-acetic silicones
MS polymer mastics
Organic timber treatments

Incompatible contact products & run-off*
Metals
Copper
Steel (non-galvanised)
Gypsum dust/limestone dust
Woods
Larch
Oak
Chestnut
Red cedar
Douglas fir
White cedar
All woods with a pH < 5
Miscellaneous materials
Mortar
Building paper
Bituminous membranes
Fire retardant & preservative treatments
Acidic cleaners (brick cleaner etc)
Acetic silicones
Metal salt timber treatments

* This list is not exhaustive

VMZ Standing seam

Standing seam facades

Standing seam panels as walls and soffits

VMZINC can be used as a standing seam panel for all vertical walls as well as soffits. The structure must be a cold ventilated one using either VMZINC on vented open gap boarding or VMZINC PLUS on vented plywood (humidity classes 1 to 4). The vented air space must be at least 38mm wide. The panels can be installed vertically, horizontally or even diagonally but panel length should not exceed 4m. Although zinc standing seam panels are not as flat as some other VMZINC facade systems it is possible to reduce unevenness by reducing panel width to 430mm and zinc thickness to 0.8mm. The use of a single lock also increases panel flatness.

Single lock standing seam

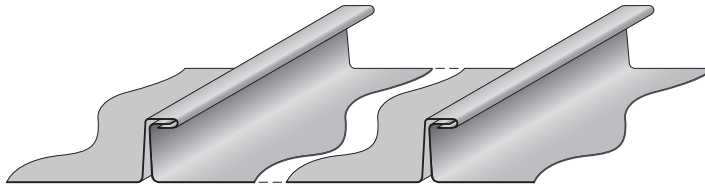

VMZINC
FACADE



Integrated Design Consultants

VMZ Standing seam

Heritage – batten cap roofing

Longevity and versatility

VMZINC has been used as a material for heritage projects for almost two hundred years. VMZINC produces ornaments such as finials, weathervanes and bull's eye windows. These elements exist in both standard shapes and sizes as well as completely bespoke products. The batten cap roofing system is often a more appropriate choice for traditional buildings.

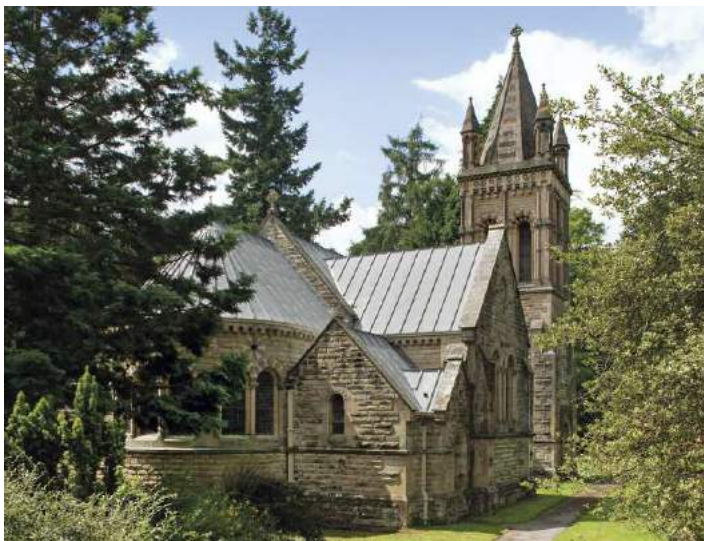
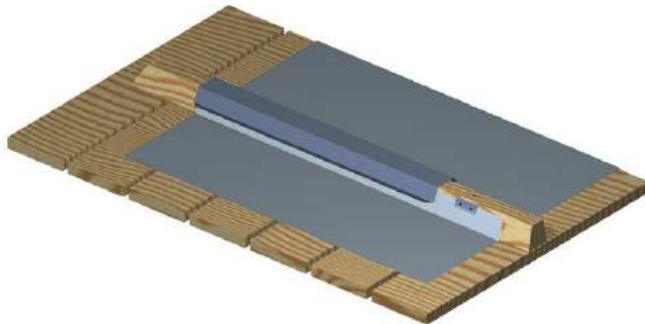

VMZINC
ROOFING

VMZINC
ORNAMENTS



VMZ Standing seam

Other VMZINC systems

Rainwater systems

Whether for new build or refurbishment, VMZINC rainwater systems have been designed to complement a wide range of building materials and styles. Pre-weathered finishes offer exceptional colour stability while developing the natural, self-protecting patina for which zinc is renowned. This ensures that maintenance requirements will be minimal throughout the systems' design life and that the material's installed appearance will be retained for many years.



Rainscreen facades

VMZINC can be installed using the principle of a rainscreen facade. There are a number of panel types and sizes available. These include **Interlocking Panels** which can be installed horizontally or vertically in all finishes. Alternatively for very large panels **VMZ Composite** is an excellent solution. Combining the qualities, elegance and durability of VMZINC with the rigidity and smoothness of composite technology, VMZ Composite offers unique architectural possibilities for facades.

Sine Wave Panels offer an alternative design in zinc as do **Overlapping Panels** whilst remaining cost effective solutions for rainscreen cladding. **Flat Lock Panels** can be used on a facade in many formats, sizes and in all finishes of VMZINC.





Subject

The subject of this document is intended for specifiers (building project architects and design teams) and users (companies responsible for installation on the building site) of the designated product or system. Its purpose is to provide the main information, text and diagrams, relating to specification and installation. Any use or specification outside the area of use and/or specifications contained in this brochure requires specific consultation with the Umicore technical departments. This does not commit the latter to any responsibility with regard to the feasibility of the design or implementation of these projects.

Countries of application

This document applies exclusively to the specification and installation of the designated products or systems on building sites in the United Kingdom and the Republic of Ireland.

Qualifications and reference documents

Please note that the specification of all construction systems for a given building remains the exclusive responsibility of its design team, who must, in particular, ensure that the specified products are suitable for the purpose of the building and compatible with the other products and techniques used. Please note that the correct use of this manual requires knowledge of VMZINC materials and of the zinc roofing profession. While construction is underway all standards in force must be respected. A video showing the installation process is available via download from www.vmzinc.co.uk or www.vmzinc.ie. Furthermore, Umicore offers training courses specifically for professionals.

Responsibility

The specification and installation of VMZINC products manufactured by Umicore are the sole responsibility of the architects and building professionals who must ensure these products are used in a way suited to the end purpose of the construction and that they are compatible with other products and techniques used. The specification and installation of the products implies respecting the standards in force and the manufacturer's recommendations. In this regard, Umicore publishes and regularly updates specification and installation manuals for specific geographic areas and provides training courses. All the information on the latter can be obtained from the local VMZINC team. Unless otherwise agreed in writing, Umicore cannot be held responsible for any damages resulting from a specification or installation that does not respect all of Umicore's specifications and the above standards and practices.



Umicore Marketing Services UK
Collier House,
Mead Lane,
Hertford, Herts, SG13 7AX

Tel 01992 822288
Fax 01992 584460
Web www.vmzinc.co.uk
Web www.vmzinc.ie

