

ROOFING

Company Overview

Welsh Slate Ltd. is the world's leading supplier of high-quality slate for a range of exterior and interior design applications. Over 500 million years old, the material is widely recognised as the finest natural slate in the world.

Welsh Slate Ltd. own and operate the famous Penrhyn and Cwt-y-Bugail quarries in North Wales and has been supplying the world with high quality slate for hundreds of years. Penrhyn Quarry has been producing roofing slate since the thirteenth-century and has been the centre and the focal point for UK natural stone for over 700 years.

In recent decades new sources of roofing slate have come into production from all over the world but none have come close to matching the appearance and performance of Welsh slate. Indeed Welsh Slate Ltd. has been exporting to the known world since shipping began and its export markets continue to grow.

Welsh Slate Ltd is committed to conducting its business in an environmentally responsible manner by maximising the environmental benefits, minimising the environmental impact and promoting sustainable development within its operations and services.

Introduction

The lifetime of a building begins with the choice of materials and for hundreds of years, architects and designers have been inspired by the natural beauty of slate. Through its aesthetic potential and practical qualities this material's unique character enhances the architectural vision.

Welsh Slate roofing is extracted from some of the world's finest deposits. Formed up to 590 million years ago, each piece of slate has its own unique fingerprint that reflects the power and presence of the landscapes from which it was hewn.

Longevity and value

There is no other roofing material which has demonstrated the extraordinary durability of Welsh Slate. With over 100 years of useful life, Welsh Slate is a very cost effective roofing material.

Benefits of Welsh Slate roofing:-

- Aesthetically pleasing
- Colour-fast
- Highly durable
- UK manufactured
- 100 year+ useful life
- Unaffected by normal extremes of temperature
- Highly resistant to acids, alkalis and other chemicals

Welsh Slate manufacture the following products:

- Roofing
- Flooring
- Paving
- Cladding
- Walling
- Worktops
- Aggregates
- Minerals
- Slate Tableware





Welsh Slate roofing material is available in two colours that reflect the true nature of beauty.

These subtle and elegant colours are further complemented by the distinctive natural texture of slate, creating an added dimension to any roof whilst the variety of colours can be used to create a pattern or subtle contrast in a design.

These aesthetic qualities are combined with the material's natural durability and resistance to weather and temperature, making slate superbly adaptable and ideal for all environments.

As Welsh Slate produces only natural products from the finest raw material each slate has its own unique visual characteristics. Cwt-y-Bugail slate features natural Blue Grey banding. Penrhyn Quarry slate has natural Heather Blue tonal variations and may include natural green marking.

The quality of slate allows roofing slate to be produced up to 42" long as standard.

St. Pancras Station, London

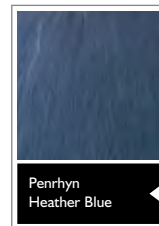
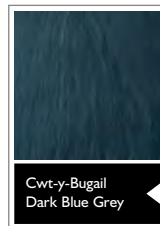



Advantages of Slate

PRACTICAL

Welsh Slate is exceptionally durable. It is unaffected by normal extremes of temperature and is highly resistant to acids, alkalis and other chemicals. It retains its colour, even in UV light and is impermeable to water. Welsh Slate is non-combustible and is compatible with all other building materials.

AESTHETIC

Welsh Slate combines beautifully with traditional and modern materials and provides the designer with a choice of colours and a natural, distinctive, texture. A Welsh Slate roof adds character and quality to any building.

PROVEN LONGEVITY

Welsh Slate has hundreds of years of history and has proven to be the highest quality roofing material in the world. Welsh Slate can provide numerous case studies and 100 year guarantees are available.

COST EFFECTIVE

Although with an initial higher cost outlay, Welsh Slate is proven cost effective over the lifetime of the building. Welsh Slate is less costly to maintain than cheaper alternatives.

3 <

Manufacturing Process

Welsh Slate roofing is crafted using traditional skills and techniques developed over centuries, combined with modern production processes to ensure all our roofing slates are of the highest standard.

Slates are then dressed to their final size with traditional chamfered edges, graded for thickness and packed for despatch.



ENVIRONMENTALLY RESPONSIBLE

Unlike many other roofing products, Welsh Slate is entirely produced in the UK. Our roofing slate is 100% natural and has a low carbon footprint to the UK market. In addition all Welsh Slate products are produced to the exacting standards of ISO 14001 Environmental Management System. (see page 30 for more details)



Exxon HQ, Fort Worth, Texas

TECHNICAL SUPPORT AND ADVICE

Welsh Slate Ltd. is dedicated to satisfying the needs of its customers through the provision of quality services and products combined with comprehensive after sales support.

Detailed technical advice is freely available from the company's highly trained and experienced Technical Department with an unrivalled knowledge of natural roofing slates. This includes assistance with roof specification, cost estimates and standard CAD details.

Welsh Slate Ltd. also offers NBS plus, allowing easy access and the accurate specification of Welsh Slate roofing.

RIBA APPROVED SEMINARS

Welsh Slate Ltd. provide architects and designers free CPD seminars on slate roofing, flooring and cladding.

If you would like to find out more please contact
+44 (0) 1248 600 656.





References

The most recent versions of the following References and Standards should be referred to when specifying or fixing natural slate roofing products.

BS EN 12326-1
Specification for slate and stone products for discontinuous roofing and cladding.

BS EN 13707
Specification for flexible sheets for waterproofing.

BS 5534
Code of practice for slating and tiling.

BS 8000
Workmanship on building sites: Part 6, Code of practice for slating and tiling of roofs and claddings.

BS 1202
Specification for nails.

BS EN 1991
A specification for assessing wind loads on building structures.

BS 5250
Code of practice for control of condensation in buildings.

BS 8104
Code of practice for assessing exposure to wind-driven rain.

All Standards and References used throughout our information are the most recent applicable versions.

DESIGN SPECIFICATIONS

- 8 Terminology
- 9 Driving Rain Index
- 10 Minimum Recommended Headlaps
- 11 General Properties
- 12 Slate sizes and weights
- 13 Coverage
- 14 Battening and Holing Gauges

TECHNICAL DETAILS

- 15 The Slating Process
- 16 Scottish Roofing Practice
- 17 Battening
- 19 Eaves and Verges
- 20 Valleys
- 21 22 Hips
- 23 Abutments
- 24 Ridges
- 25 Changes in Roof Pitch
- 26 Vertical Slating
- 27 28 Roof Ventilation

Design Specification

7

General guidance on design is given here based on the recommendations of BS 5534. For further detail, please refer to a full version of BS 5534 Code of Practice for Slating and Tiling.

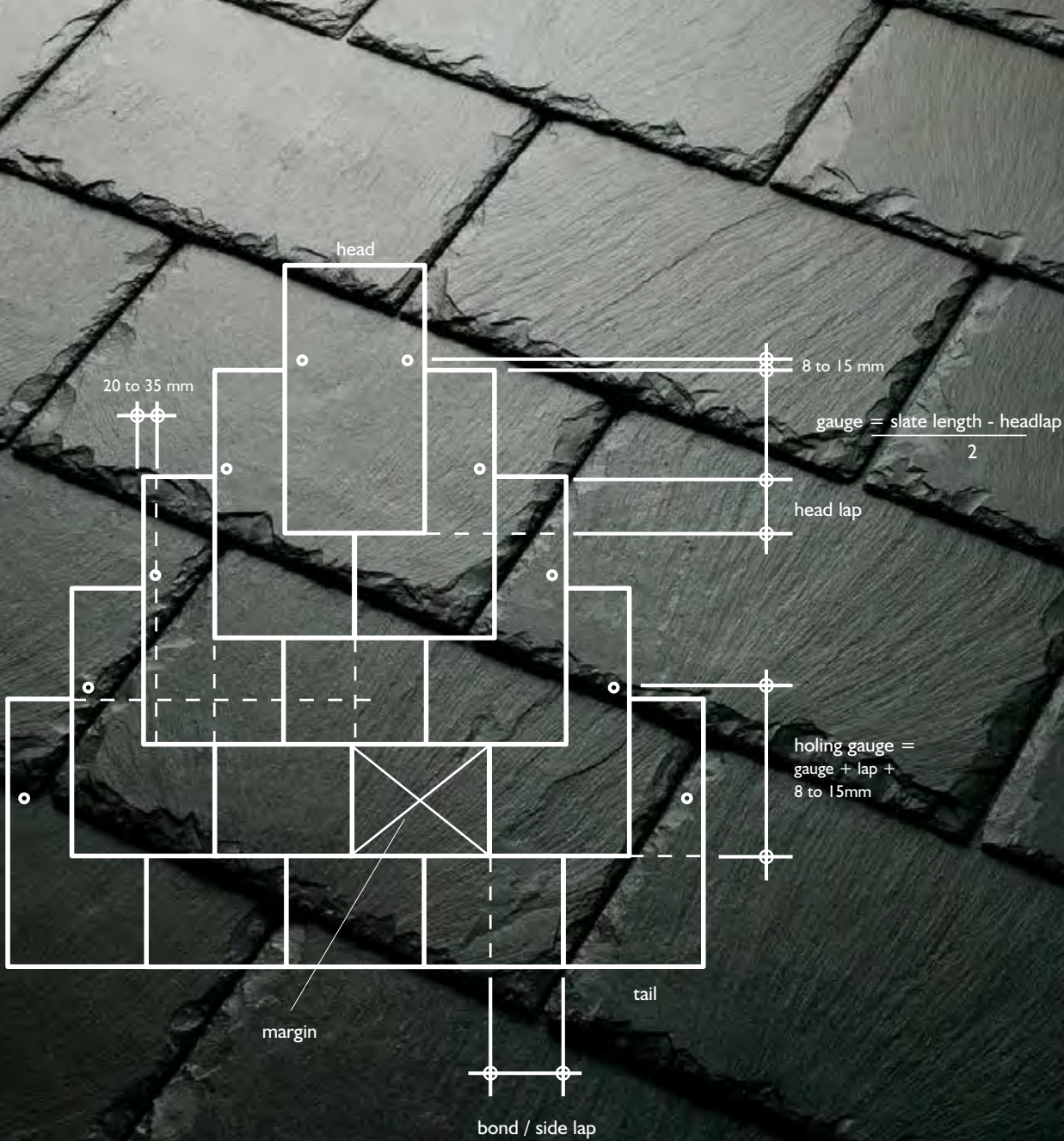

Terminology

The above diagram gives a brief explanation of the terms that are commonly used throughout the roofing industry. They are by no means comprehensive and the terms may vary in different parts of the country. We suggest that further reference is made to BS 6100 Building & Civil Engineering Terms.

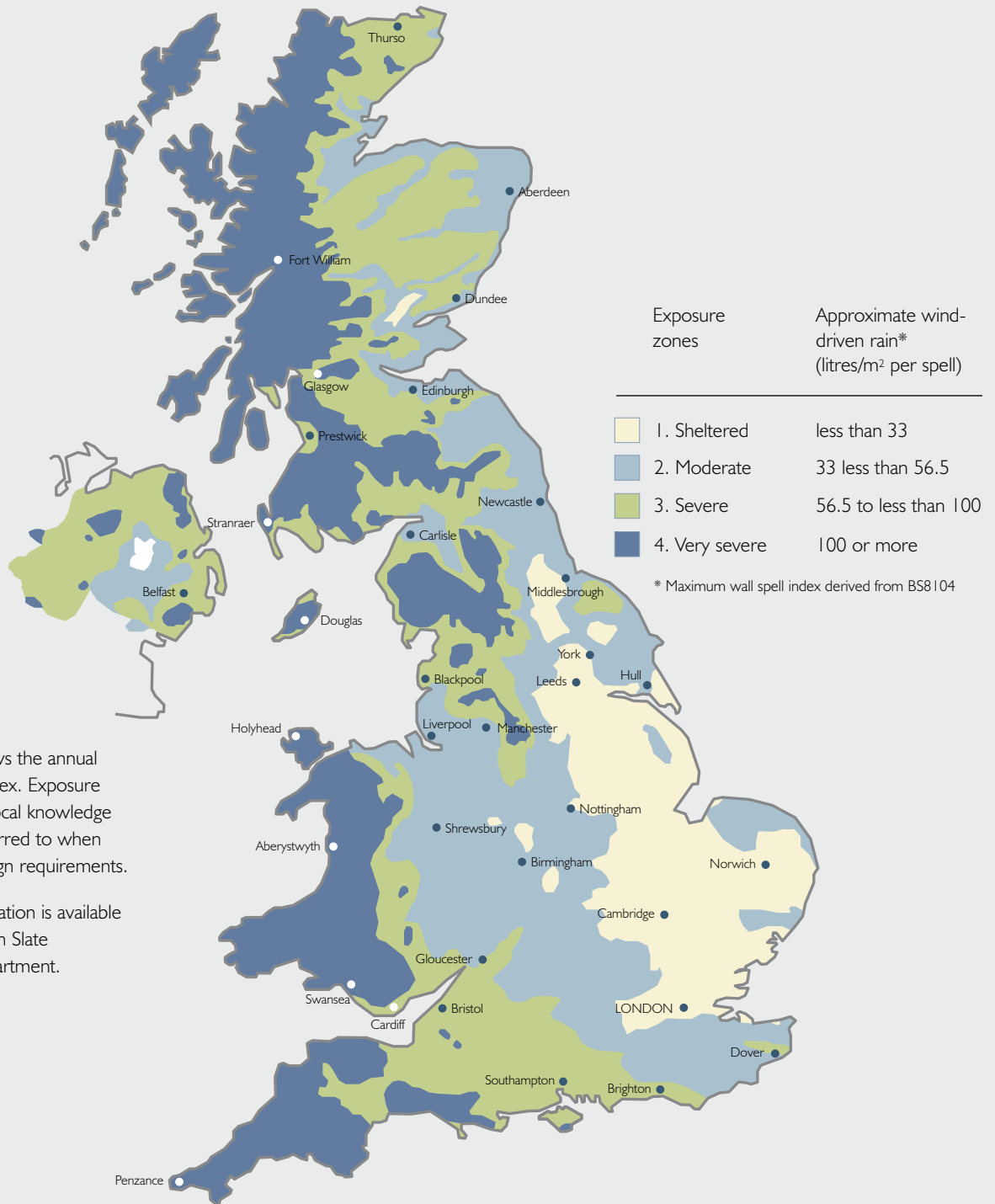

This map shows the annual driving rain index. Exposure gradings and local knowledge should be referred to when discussing design requirements.

Further information is available from the Welsh Slate Technical Department.

Annual driving rain index

UNITED KINGDOM

In general, any area within 30 miles of a west facing coastline is considered to be in a severe exposure area.

However, localised effects on any site must also be taken into consideration.

Further reference to BS 8104 is advisable to ascertain localised effects.

Map based on BS 5534.

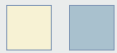
**Less than 56.5 l/m² per spell**

Size (Nominal) mm	Minimum Rafter Pitch									
	20°	22.5°	25°	27.5°	30°	35°	40°	45° to 75°	85°	
600 x 350	115*	105*	95*	85*	80*	70*	60*	55*	50*	
600 x 300	-	-	95*	85*	80*	70*	60*	55*	50*	
550 x 300	-	105*	95*	85*	80*	70*	60*	55*	50*	
500 x 300	115*	105	95	85	80	70	60	55	50*	
500 x 250	-	-	95	85	80	70	60	55	50	
450 x 300	-	-	-	-	80	70	60	55	50	
450 x 250	-	-	-	-	80	70	60	55	50	
400 x 300	-	-	-	-	80	70	60	55	50	
400 x 250	-	-	-	-	80	70	60	55	50	
400 x 200	-	-	-	-	80	70	60	55	50	
350 x 300	-	-	-	-	80	70	60	55	50	
350 x 250	-	-	-	-	80	70	60	55	50	
350 x 200	-	-	-	-	80	70	60	55	50	
300 x 200	-	-	-	-	80	70	60	55	50	
270 x 180	-	-	-	-	80	70	60	55	50	

**56.5 l/m² or greater per spell**

Size (Nominal) mm	Minimum Rafter Pitch									
	20°	22.5°	25°	27.5°	30°	35°	40°	45° to 75°	85°	
600 x 350	150*	130*	120*	110*	100*	85*	80*	70*	65*	
600 x 300	-	-	120*	110*	100*	85*	80*	70*	65*	
550 x 300	-	130*	120*	110*	100*	85*	80*	70*	65*	
500 x 300	-	130*	120*	110*	100*	85*	80*	70*	65*	
500 x 250	-	-	-	110*	100*	85*	80*	70*	65*	
450 x 300	-	-	-	-	100*	85*	80*	70*	65*	
450 x 250	-	-	-	-	100*	85	80	70	65	
400 x 300	-	-	-	-	100*	85	80	70	65	
400 x 250	-	-	-	-	100	85	80	70	65	
400 x 200	-	-	-	-	100	85	80	70	65	
350 x 300	-	-	-	-	100	85	80	70	65	
350 x 250	-	-	-	-	100	85	80	70	65	
350 x 200	-	-	-	-	100	85	80	70	65	
300 x 200	-	-	-	-	100	85	80	70	65	
270 x 180	-	-	-	-	100	85	80	70	65	

* Marked items may require longer or improved ring shank nails at roof junctions (eaves, verges, ridge, hips etc). Specific fixing calculations can be carried-out for projects. For further details please contact Welsh Slate Technical Department.

Minimum Recommended Headlaps

The recommendations for minimum pitches and laps for slate apply to normal situations. In general, the recommendations apply to rafter lengths of not more than 9m in moderate driving rain exposures and 6m in severe driving rain exposures. Specifiers should take account of any abnormal condition that might apply and may need to specify greater values than the recommended minima. If it is necessary to use pitches lower than the recommended minima please contact Welsh Slate technical department.

This table gives a range of sizes for your information. Traditional sizes that are not listed above and random diminishing slates can be made to special order, please contact us for more information.

WIND LOAD AND WEATHER RESISTANCE

Slates fixed in accordance with the details given in this guide will have adequate resistance to wind loads, wind uplift and rain penetration under most conditions. The tables above give minimum recommended laps according to exposure, roof pitch and slate size. Detailed guidance on wind load calculations is given in BS 5534 and BS EN 1991.

Welsh Slate benefits from a number of highly practical properties. It is exceptionally durable, unaffected by normal extremes of temperature and is highly resistant to acids, alkalis and other chemicals.

In addition, slate is non-combustible, retains its colour, even in UV light and is impermeable to water.

Water permeability	Impermeable
Sunlight unfading	Unaffected by UV light
Heat	Unaffected by normal heating, freezing and thermal cycling
Chemical resistance	Unaffected by atmospheric pollution, sea air and sea spray
Biological resistance	Unaffected by vegetable growth, rot or insect attack
Compatibility	Compatible with all building materials
Fire resistance	Slate is non combustible and does not support combustion. AA fire rating
Thermal expansion	8.5 - 11 x 10 ⁻⁶ mm per °C
Thermal conductivity	Approx. 2.0 W/mk

Certificates of compliance can be downloaded from our website www.welshslate.com

Conformity to ASTM

Requirements for S1 classification (expected use of 75 years plus)

- C120** Breaking load > 2558N
- C121** Water absorption <0.25%
- C217** Weather resistance <0.05mm

All slates comply with S1 classification.

Conformity and testing to BS EN 12326

All our slates comply with W1, S1, and T1 classification. Conformity also ensures that all slates are CE marked.



H631

Roofing slates produced at Penrhyn quarry are certified by the Belgium Construction Certification Association, and carry the ATG mark.



General Properties

11

Further technical properties and test results are available from the Welsh Slate Technical Department or online at www.welshslate.com

Please contact us for further information and details of availability on Tel: +44 (0) 1248 600656

STANDARD SIZES & WEIGHTS IN TONNES PER 1000 SLATES

Size (Nominal) mm	Penrhyn Heather Blue		
	Capital	County	Celtic
	5.5mm	7mm	9mm
600 x 350	3.23	4.12	5.29
600 x 300	2.77	3.53	4.54
550 x 300	2.54	3.23	4.16
500 x 300	2.31	2.94	3.78
500 x 250	1.93	2.45	3.15
450 x 300	2.08	2.65	3.40
450 x 250	1.73	2.21	2.84
400 x 300	1.85	2.35	3.02
400 x 250	1.54	1.96	2.52
400 x 200	1.23	1.57	2.02
350 x 300	1.62	2.06	2.65
350 x 250	1.35	1.72	2.21
350 x 200	1.08	1.37	1.76
300 x 300	1.39	1.76	2.27
300 x 250	1.16	1.47	1.89
300 x 200	0.92	1.18	1.51

STANDARD SIZES & WEIGHTS IN TONNES PER 1000 SLATES

Size (Nominal) mm	Cwt Y Bugail Dark Blue Grey		
	Capital	County	Celtic
	5.5mm	7mm	9mm
600 x 300	2.62	3.34	4.29
550 x 300	2.40	3.06	3.94
500 x 300	2.19	2.78	3.58
500 x 250	1.82	2.32	2.98
450 x 250	1.64	2.09	2.68
400 x 250	1.46	1.86	2.39
400 x 200	1.17	1.48	1.91
350 x 250	1.28	1.62	2.09
350 x 200	1.02	1.30	1.67
300 x 300	1.31	1.67	2.15
300 x 250	1.09	1.39	1.79
300 x 200	0.87	1.11	1.43

Slate Sizes and Weights

The weights shown are exclusive of any packaging, or crating material. The weights for other thicknesses or sizes are available on request from our Technical Department.

The above weights are approximate. Slate thickness quoted are nominal and subject to variation.

Other sizes may be available, please contact us for further information.

Coverage: Slates/m²

Size (Nominal)	Lap mm																
mm	50	55	60	65	70	75	80	85	90	95	100	105	110	115	120	130	150
600 x 350	10.2	10.3	10.4	10.5	10.6	10.7	10.8	10.9	11.0	11.2	11.3	11.4	11.5	11.6	11.7	12.0	12.5
600 x 300	11.9	12.0	12.1	12.3	12.4	12.5	12.6	12.7	12.9	13.0	13.1	13.2	13.4	13.5	13.7	14.0	14.6
550 x 300	13.1	13.2	13.4	13.5	13.7	13.8	14.0	14.1	14.3	14.4	14.6	14.7	14.9	15.1	15.2	15.6	16.4
500 x 300	14.6	14.7	14.9	15.1	15.2	15.4	15.6	15.8	16.0	16.2	16.4	16.6	16.8	17.0	17.3	17.7	18.7
500 x 250	17.4	17.6	17.8	18.0	18.2	18.5	18.7	18.9	19.1	19.4	19.6	19.9	20.1	20.4	20.6	21.2	22.4
450 x 300	16.4	16.6	16.8	17.0	17.3	17.5	17.7	18.0	18.2	18.5	18.7	19.0	19.3	19.6	19.9	20.5	21.9
450 x 250	19.6	19.9	20.1	20.4	20.6	20.9	21.2	21.5	21.8	22.1	22.4	22.7	23.1	23.4	23.8	24.5	26.1
400 x 300	18.7	19.0	19.3	19.6	19.9	20.2	20.5	20.8	21.2	21.5	21.9	22.2	22.6	23.0	23.4	24.3	
400 x 250	22.4	22.7	23.1	23.4	23.8	24.1	24.5	24.9	25.3	25.7	26.1	26.6	27.0	27.5	28.0	29.0	
400 x 200	27.9	28.3	28.7	29.1	29.6	30.0	30.5	31.0	31.5	32.0	32.5	33.1	33.6	34.2	34.8	36.1	
350 x 300	21.9	22.2	22.6	23.0	23.4	23.8	24.3	24.7	25.2	25.7	26.2	26.8	27.3				
350 x 250	26.1	26.6	27.0	27.5	28.0	28.5	29.0	29.6	30.2	30.8	31.4	32.0	32.7				
350 x 200	32.5	33.1	33.6	34.2	34.8	35.5	36.1	36.8	37.5	38.3	39.0	39.8	40.7				
300 x 300	26.2	26.8	27.3	27.9	28.5	29.1	29.8	30.5	31.2	32.0	32.8						
300 x 250	31.4	32.0	32.7	33.4	34.1	34.9	35.7	36.5	37.3	38.3	39.2						
300 x 200	39.0	39.8	40.7	41.5	42.4	43.4	44.3	45.4	46.5	47.6	48.8						

Values calculated using nominal sizes and incorporating a 5mm joint gap as per BS 8000: Part 6. We recommend the addition of at least 5% wastage allowance.

This table gives a range of sizes for your information. Other sizes may be available, please contact us for further information.

Coverage

COVERAGE AND COST

The actual cost of a roof per unit floor area of the building is determined by a number of factors, including roof pitch, slate size and head lap.

ROOF PITCH AND LAP

Project specific advice is available from the Welsh Slate Technical Department.

	Battening gauge mm	m batten per m ²	Holing gauge mm	Battening gauge mm	m batten per m ²	Holing gauge mm	Battening gauge mm	m batten per m ²	Holing gauge mm	Battening gauge mm	m batten per m ²	Holing gauge mm
Headlap		50mm			55mm			60mm			65mm	
Slate length mm												
600	275	3.64	335	273	3.67	338	270	3.70	340	268	3.74	343
550	250	4.00	310	248	4.04	313	245	4.08	315	243	4.12	318
500	225	4.44	285	223	4.49	288	220	4.55	290	218	4.60	293
450	200	5.00	260	198	5.06	263	195	5.13	265	193	5.19	268
400	175	5.71	235	173	5.80	238	170	5.88	240	168	5.97	243
350	150	6.67	210	148	6.78	213	145	6.90	215	143	7.02	218
300	125	8.00	185	123	8.16	188	120	8.33	190	118	8.51	193
Headlap		70mm			80mm			85mm			90mm	
Slate length mm												
600	265	3.77	345	260	3.85	350	257.5	3.88	352.5	255	3.92	355
550	240	4.17	320	235	4.26	325	232.5	4.30	327.5	230	4.35	330
500	215	4.65	295	210	4.76	300	207.5	4.82	302.5	205	4.88	305
450	190	5.26	270	185	5.41	275	182.5	5.48	277.5	180	5.56	280
400	165	6.06	245	160	6.25	250	157.5	6.35	252.5	155	6.45	255
350	140	7.14	220	135	7.41	225	132.5	7.55	227.5	130	7.69	230
300	115	8.70	195	110	9.09	200	107.5	9.30	202.5	105	9.52	205
Headlap		95mm			100mm			105mm			110mm	
Slate length mm												
600	252.5	3.96	367.5	250	4.00	360	247.5	4.04	362.5	245	4.08	365
550	227.5	4.40	332.5	225	4.44	335	222.5	4.49	337.5	220	4.55	340
500	202.5	4.94	307.5	200	5.00	310	197.5	5.06	312.5	195	5.13	315
450	177.5	5.63	282.5	175	5.71	285	172.5	5.80	287.5	170	5.88	290
400	152.5	6.56	257.5	150	6.67	260	147.5	6.78	262.5	145	6.90	265
350	127.5	7.84	232.5	125	8.00	235	122.5	8.16	237.5	120	8.33	240
300	102.5	9.76	207.5									
Headlap		115mm			120mm			130mm			150mm	
Slate length mm												
600	242.5	4.12	367.5	240	4.17	370	235	4.26	375	225	4.44	385
550	217.5	4.60	342.5	215	4.65	345	210	4.76	350	200	5.00	360
500	192.5	5.19	317.5	190	5.26	320	185	5.41	325	175	5.71	335
450	167.5	5.97	292.5	165	6.06	295	160	6.25	300	150	6.67	310
400	142.5	7.02	267.5	140	7.14	270	135	7.41	275			

Battening and Holing Gauges

This table gives a range of sizes for your information.

Other sizes may be available, please contact us for further information.

SETTING OUT THE ROOF

For a detailed description of the process of roof slating, reference should be made to code of Practice for Slating and Tiling and BS 8000 Workmanship on Building Sites.

However, the basic steps are set out below:

- 1.1 Sort and hole slates where required. Slates should be holed from the underside to the correct gauge measured from the tail of the slate using a threaded action slate holing machine. At the same time the slates should be sorted into groups of equal thickness where required.
- 1.2 Fix the underlay as specified.
- 1.3 Mark out the roof to the correct battening gauge. The gauge may be adjusted to divide the slope length into equal margins provided the specified lap is not reduced.
- 1.4 Batten the roof (see Battening Gauges table).

- 1.5 Check the actual width of slates and mark out perpend on battens at correct centres allowing 5mm joint gaps.

SLATING

- 1.6 Where required load out the slates on the roof so that the thickest slates are in the lowest courses and the thinnest near the ridge.
- 1.7 Fix undereaves courses bed up.
- 1.8 Fix the slates to perpend lines, cutting individual slates as necessary to fit hips and valleys. Each slate must be fixed with two nails.

SLATE NAILS

- 1.9 Slate or clout nails should be aluminium to BS 1202: Part 3, copper to BS 1202: Part 2, or silicon-bronze.

In corrosive or marine atmospheres copper nails are preferable and in severe conditions silicon-bronze nails should be used.

CUTTING SLATES

- 1.10 In order to maintain adequate laps and allow proper fixing, slates must not be cut too narrow. In general no slates should be less than 150mm wide.

At all verges and abutments, alternate courses must be started either with half-width slates or with slate-and-a-half widths to maintain bond. If the half-slate would be less than 150mm, slate-and-a-half widths must be used.

At valleys, hips and other places where slates must be cut on the rake, it is essential that slates are of an adequate width to accommodate secure fixings.



The Slating Process

FIXING

Full details of the roof slating process are given in BS 5534. However, the main stages of the Traditional Scottish Practice are outlined below:

- 2.1 The roof should be covered with square edged sarking boards, covered with bitumen underlay or breather membrane, as specified by the architect. (Battens, although not generally specified, can be used to create a warm roof construction).
- 2.2 Sort and hole slates into at least three groups of equal thickness.
- 2.3 Hole the slates to the correct gauge, measuring from the tail of the slate.
- 2.4 Fix the underlay temporarily.
- 2.5 Mark out the roof to the correct gauge. This may be adjusted to divide the slope length into equal numbers of courses. Care must be taken not to reduce the specified lap.
- 2.6 Load out the slates on the roof so that the thickest slates are in the lowest courses and the thinnest near the ridge.
- 2.7 Fix undereaves courses (bed side up).
- 2.8 Fix slates to perpendicular lines, cutting slates as necessary to fit hips and valleys.
- 2.9 Although BS 5534 recommends fixing with two nails, it is generally recognised that single head nailing is acceptable where slates are small and heavy. It is also recommended that a proportion of the slates (normally every third course) should be double nailed.
- 2.10 Slate or clout nails should be aluminium to BS 1202: Part 3, copper to BS 1202: Part 2, or silicon-bronze.

In corrosive or marine atmospheres copper nails are preferable, and in severe conditions

silicon-bronze nails should be used. Slating nails should not penetrate through the board.

HOLING SLATES

- 2.11 Should slates need to be holed this must be done from the underside, using a threaded action slate holing machine. The resultant spalling on the upper surface forms a countersink for the head of the nail.

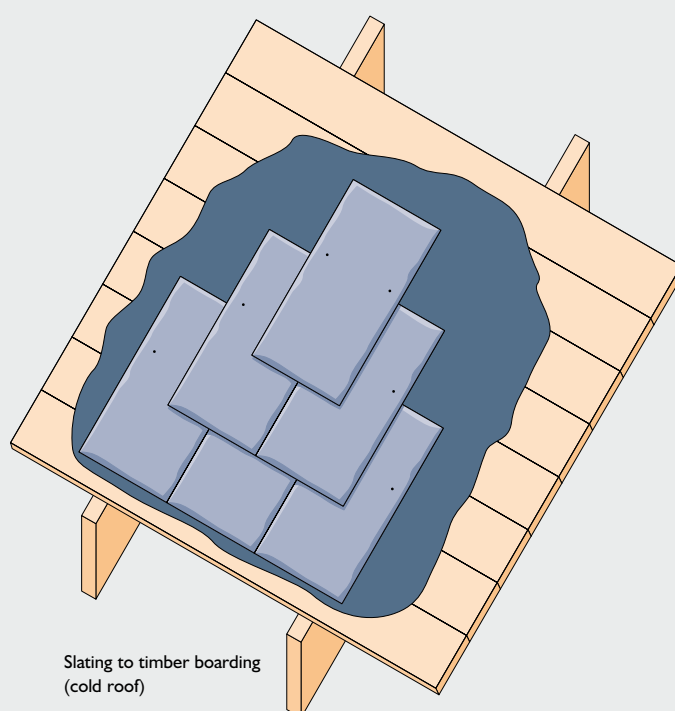

Traditional Scottish Roofing Practice

OPEN RAFTERS

Underlay should be either reinforced bitumen felt Type 1F or an approved flexible roofing membrane to BS EN 13707 and complying with the requirements of BS 5534.

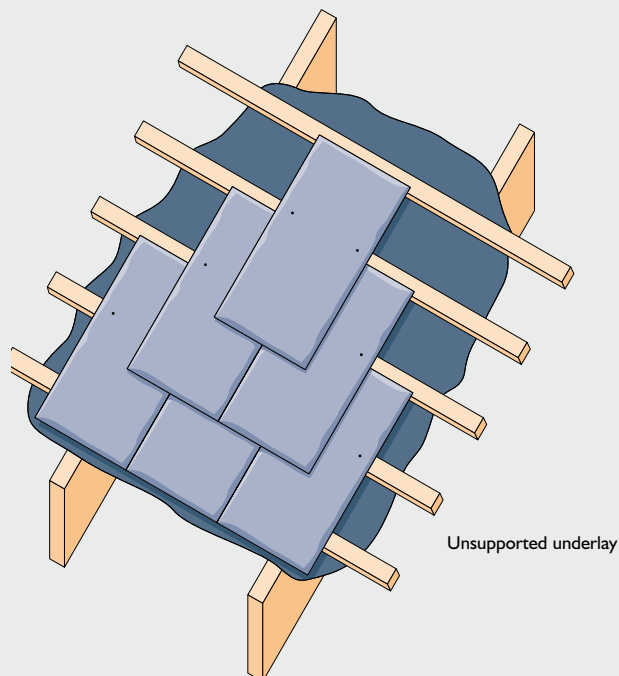

Unsupported underlay

BOARDED ROOFS

Underlay laid directly onto boards should be either reinforced bitumen felt Type 1F or an approved flexible roofing membrane to BS EN 13707 and complying with the requirements of BS 5534.

Boarded roofs should be counter battened to allow ventilation under the slates and free drainage of any water that may reach the underlay.

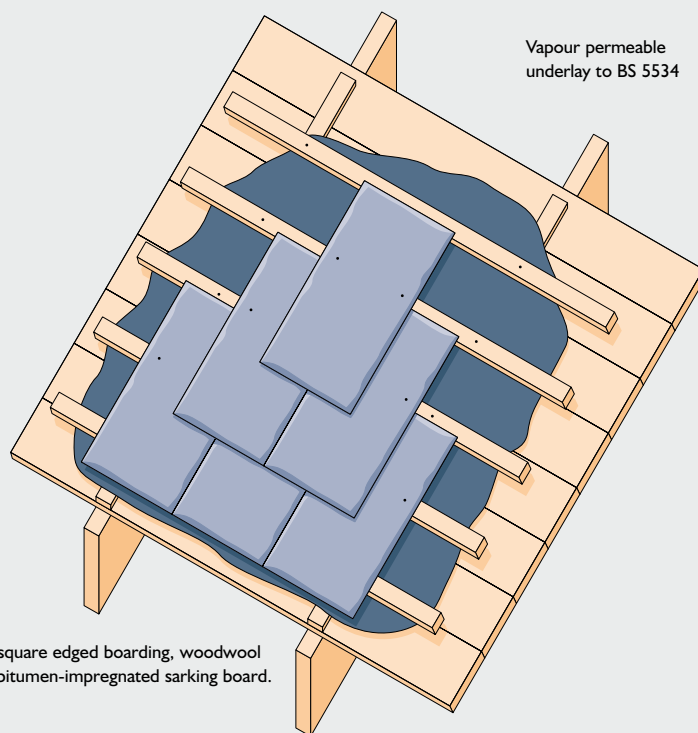

Vapour permeable underlay to BS 5534

T&G or square edged boarding, woodwool slabs or bitumen-impregnated sarking board.

Battening



NAIL SIZES

Slate Grade Nominal thickness	Nail Length x 3.35mm dia. Minimum 10mm nailhead
<7mm	30mm minimum
≥7mm	40mm minimum

Nails used throughout any roof structure should comply with the standard set out in BS 1202 : parts 2 & 3

Nail lengths should be calculated in accordance with BS 5534. The tables on page 10 give guidance to situations where the nail recommendations above should be reviewed.

MINIMUM RECOMMENDED LEAD CODES

Application	BS 5534 Code	LSA Code
Flashings	4	4
Soakers		
Abutment	3	3
Mitred hip	3	3
Mitred valley	3	3
Aprons		
Chimney	4	4
Roof head	4	4
Gutters		
Chimney	5	5
Lining	5	5
Ridge rolls	4	4
Hip rolls	4	4 (or 5)
Valley linings	4	4 (or 5)
Saddles	4	n/a

MINIMUM BATTEN SIZES

450mm Rafter Centres	600mm Rafter Centres
50mm wide x 25mm deep	50mm wide x 25mm deep
50mm wide x 25mm deep	50mm wide x 25mm deep

RECOMMENDED HEADLAPS FOR UNDERLAYS

Pitch	Minimum Headlap	
	Fully Supported	Not Supported
20°-34°	100mm	150mm
+ 35°	75mm	100mm



Private dwelling NSW, Australia

LEAD STAINING

Lead develops a patina of lead carbonate which can be washed off by rain and can cause staining of slates. It is strongly recommended that all lead which may discharge water onto slate, including soakers, should be treated with patination oil as it is fixed.

For more information contact the
Lead Sheet Association,
 Unit 10 Archers Park
 Brainbridges Road
 East Peckham
 Kent
 TN12 5HP

Tel: 01622 872432
 Fax: 01622 871649
www.leadsheet.co.uk

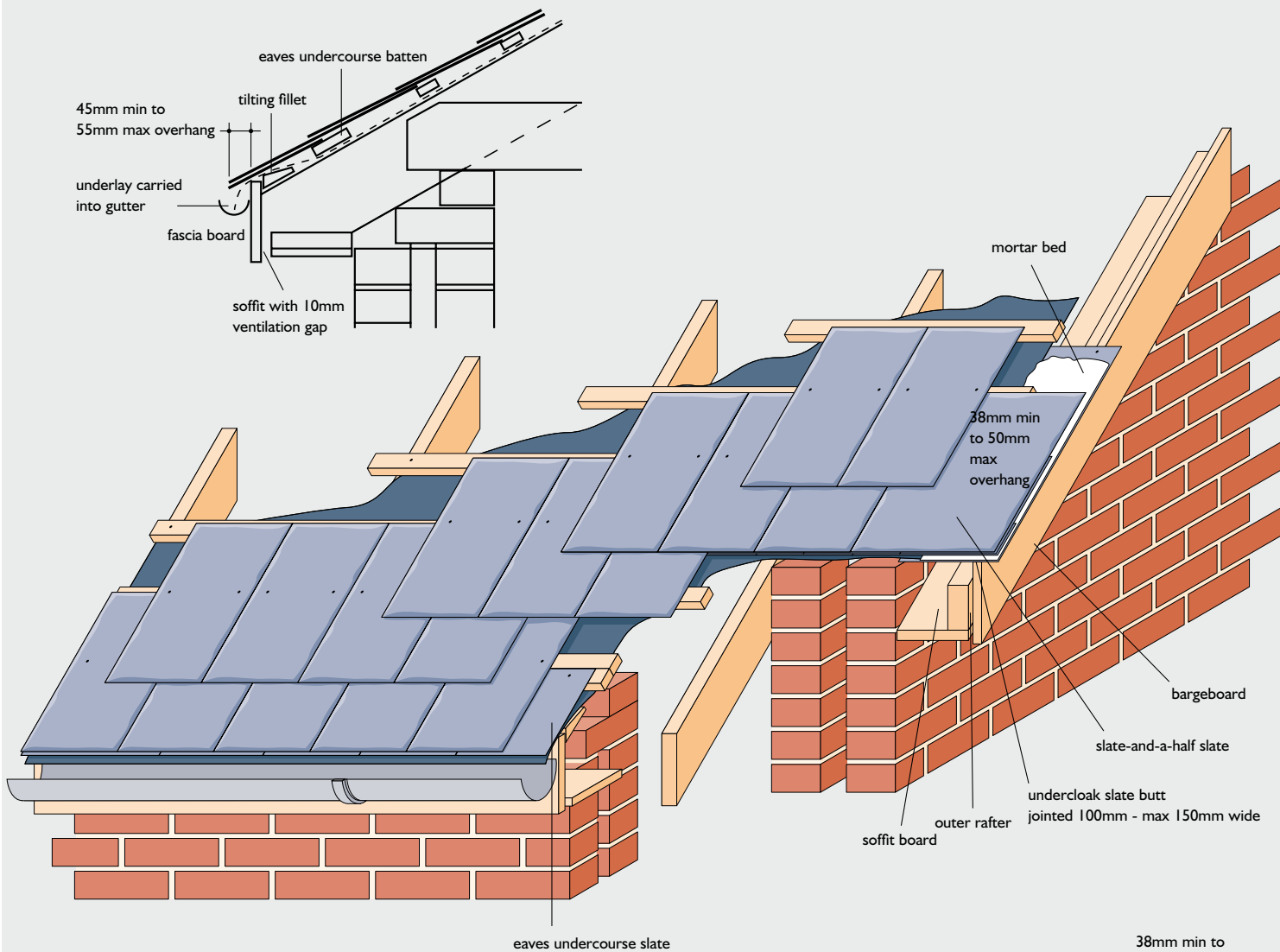

EAVES

Dress underlay into gutter and pull tight to ensure no water retaining troughs and support with tilting fillet. Fix undereaves and eaves course of slates with tails aligned and projecting 45mm (minimum) to 55mm (maximum) beyond the fascia tilting fillet or wall face. Longer slate nails may be required at the eaves courses.

Eave length should equal battening gauge plus headlap plus 25mm.

VERGE ON BRICKWORK

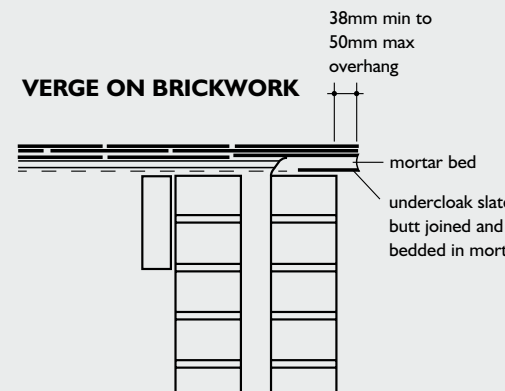

Eaves and Verges

19

VERGE ON BARGEBOARD

Ensure that undercloak and underlay are well lapped. Nail undercloak fair face down, to a true line and projecting 38mm (minimum) to 50mm (maximum) from face of bargeboard. Fill the gap between undercloak and slates with mortar, and strike off to give a neat, flush joint. Mortar for bedding and pointing, 1:3 cement:sand pigmented to match colour of slates.

VERGE ON BRICKWORK

Ensure that undercloak and underlay are well lapped. Bed undercloak in mortar fair face down, to a true line, projecting 38mm (minimum) to 50mm (maximum) beyond face of wall, and point neatly to match in with joints in walling. Cut verge slates as necessary and fix flush with undercloak. Fill the gap between undercloak and slates with mortar, and strike off to give a neat, flush joint. Mortar for bedding and pointing, 1:3 cement:sand pigmented to match colour of slates. Note: Where possible use slate-and-a-half slates to alternate courses to form verges.

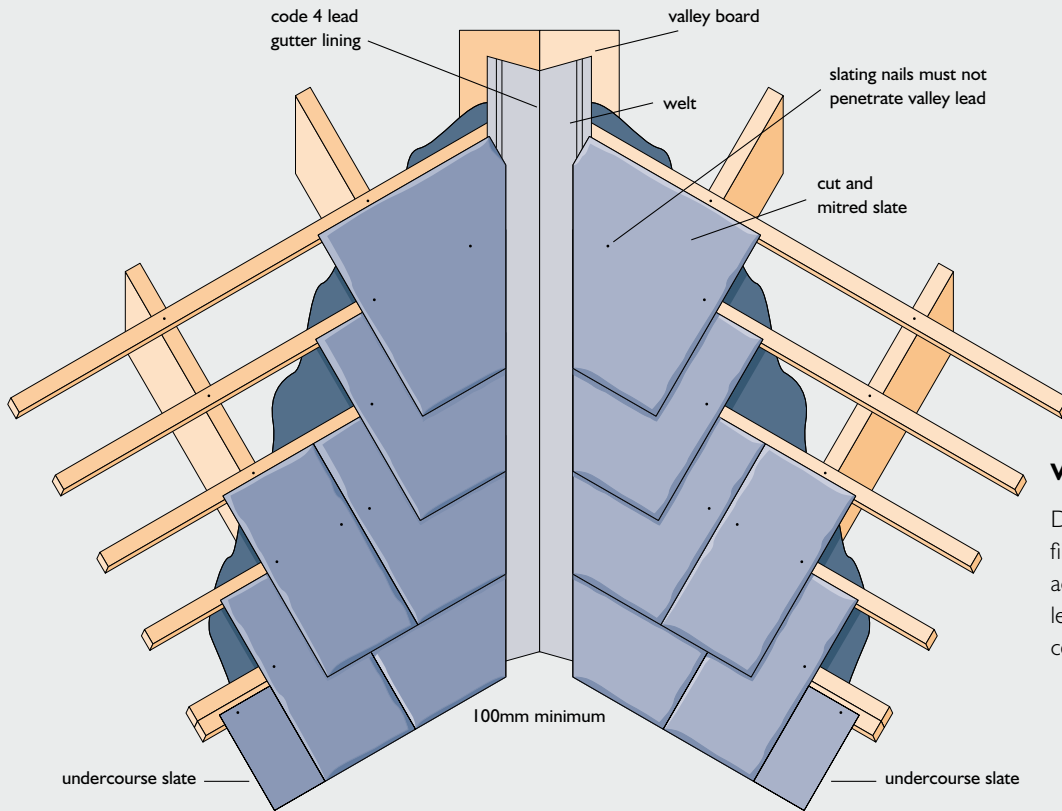

VALLEY GUTTER

Dress underlay over tilting fillets. Cut slates neatly and accurately to form a gap not less than 100mm wide centred on the gutter.

Minimum recommended open lead valleys (mm)

Roof pitch°	Area m ² (on plan)	Rain fall rate mm/hr		
		75	150	225
20-22	<25	100	125	125
	25-100	125	150	200
22.5-29	<25	100	100	100
	25-100	100	125	150
30-34	<25	100	100	100
	25-100	100	100	125
35+	<25	100	100	100
	25-100	100	100	100

Rafter length maximum = 5m for areas of up to 25m²
 Rafter length >5m and <10m for areas of up to 25-100m²
 No vertical projections drain on to roof.
 For further information please contact Welsh Slate Technical Department.

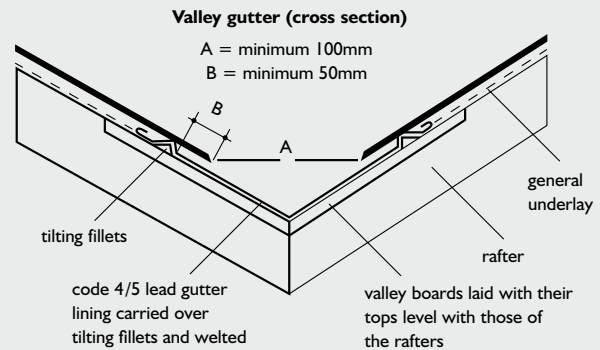

Valleys

MITRED VALLEY

Cover with a strip of underlay 600mm wide, underlapping general underlay. Cut slates neatly and accurately and interleave with lead soakers to form a straight, close, weathertight mitred junction. Fix soakers by nailing to battens at the top edge. Minimum recommended pitch is 50°, for pitches below this please contact Welsh Slate Technical Department.

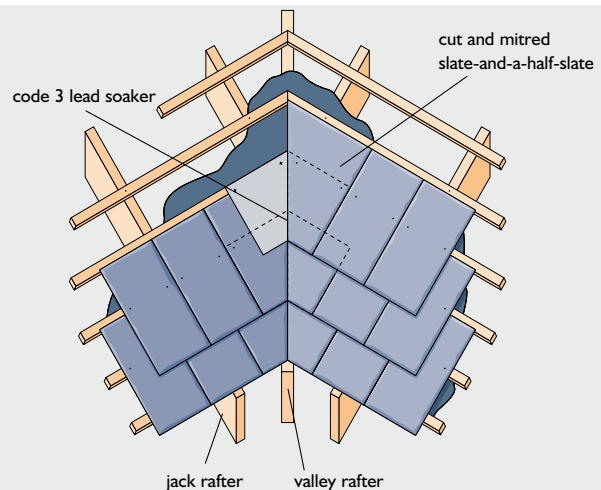

MITRED HIP

Cover with a strip of underlay 600mm wide, overlapping general underlay. Cut slates neatly and accurately, bevelled edge down. Interleave with lead soakers to form a straight, weathertight, close-mitred junction. Fix soakers by nailing to battens at the top edge.

N.B. Careful consideration must be given to mitred hip details at low roof pitches and in areas of severe exposure - contact Welsh Slate Technical Department

Mitred hips are not generally recommended below 30° pitches.

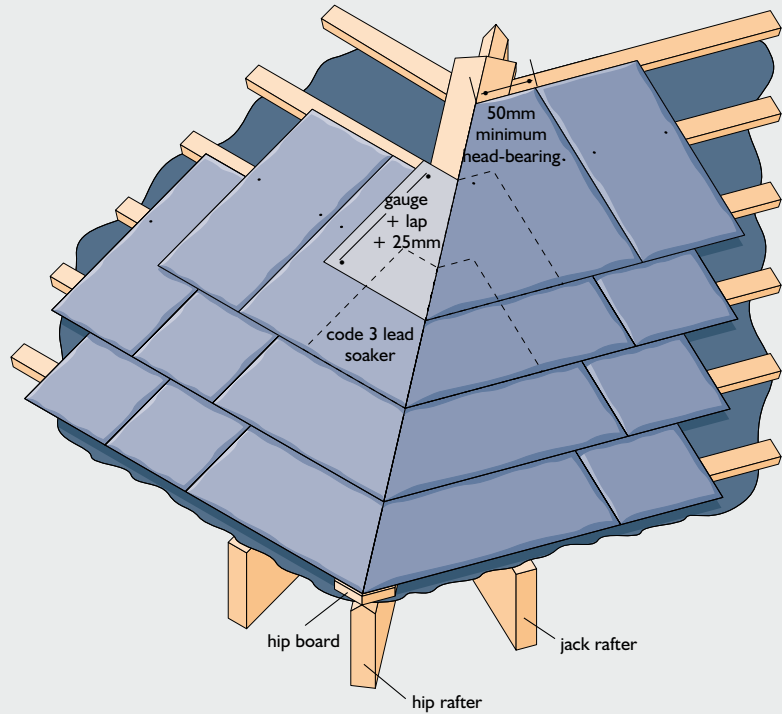

MITRED HIP SOAKER WIDTHS

Pitch	Minimum Width at head
30°-35°	150mm
35° +	100mm

Hips

21



TILED HIP

Cover with a strip of underlay 600mm wide, overlapping general underlay. Fix hip iron to hip rafter with 5mm hot dipped galvanised screws or nails.

Hip irons to BS 5534, hot-dip galvanised after manufacture. Cut slates to fit closely at junction. Make weathertight with ridge tiles laid to a true line with edges and joints, solidly bedded in mortar. Provide mechanical fixing to each hip tile (generally a screw and sealing washer fixed into hip rafter or extra hip batten), and neatly strike off flush with mortar as work proceeds. Shape first tile to align with corner of eaves and fill end with mortar and slips of slate finished flush. Mortar for bedding hip tiles 1:3 cement:sand pigmented to approved colour.

METAL ROLL HIPS

Metal roll hips should conform with sheet metal technical recommendations.

For advice on pitches less than 30°, contact the Welsh Slate Technical Department.

TILED HIP

Non corroding screws and sealing washer or other recommended mechanical fixing to resist wind uplift

hip tiles bedded and jointed in mortar

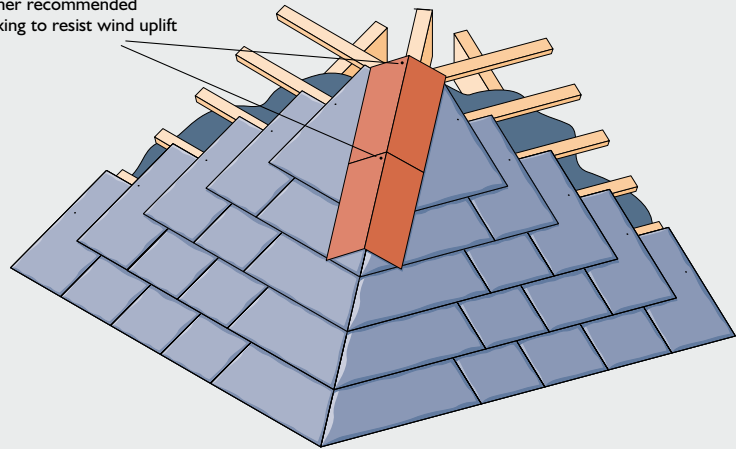

HIP WITH LEAD ROLL

lead tack 50 mm wide at 750 mm centres under timber roll

50 mm timber roll

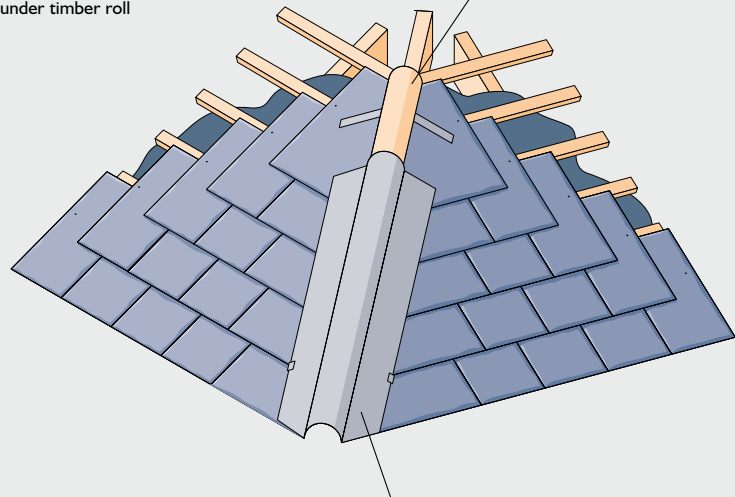

code 4 lead hip, 460 to 500 mm wide, 1.5 to 1.8 m lengths with 75 mm lapped joints



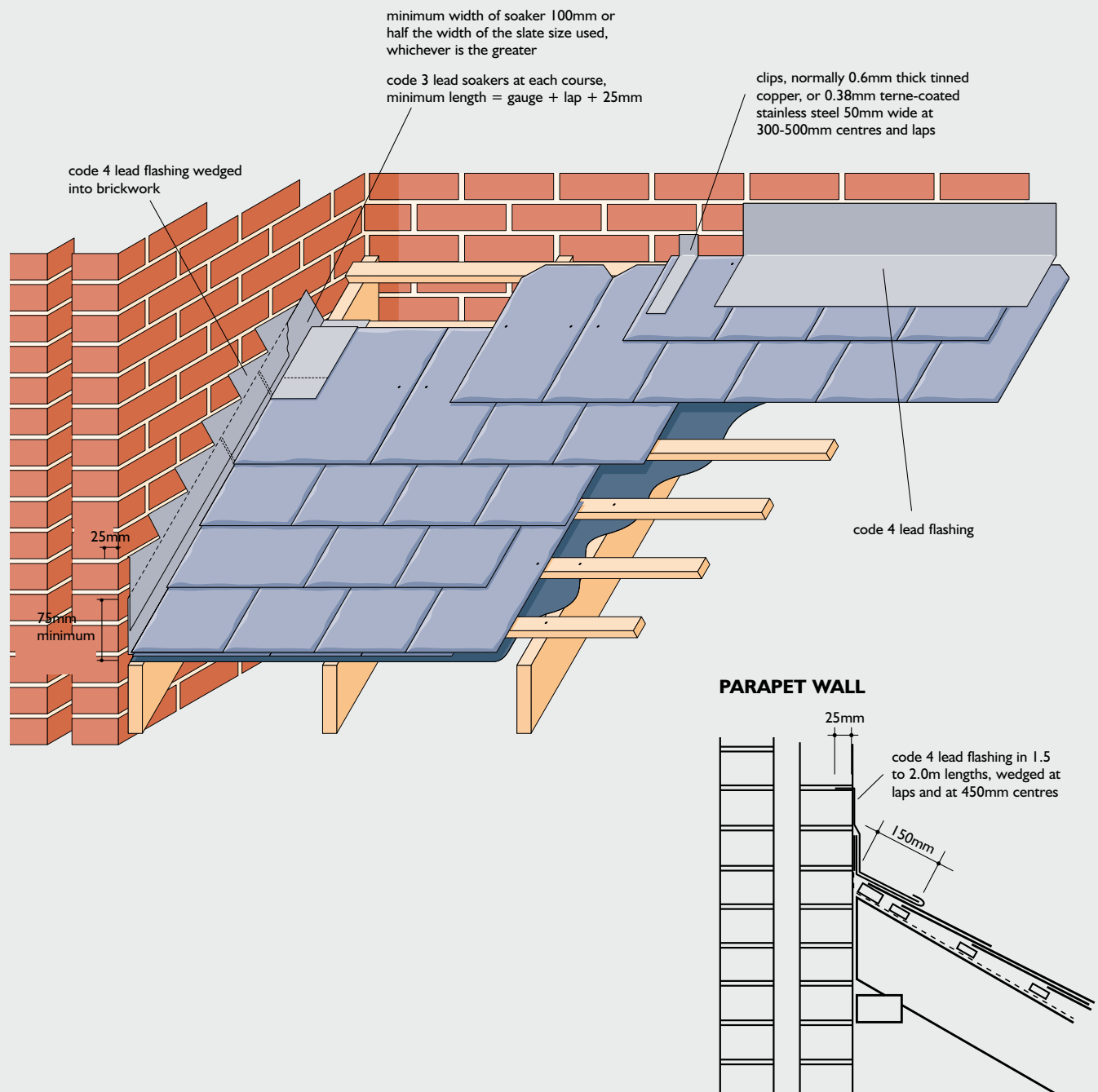

Abutments

SLOPING EDGE

Cut slates as necessary and interleave with lead soakers to form a close, weathertight abutment. Fix soakers by turning down over the head of each slate. Ensure that lead flashings are neatly dressed down over soakers immediately after slating is complete.

TOP COURSE

Turn underlay 100mm up abutment. Finish slating with a head-nailed short course to maintain gauge. Ensure that flashings are fixed immediately after slating is complete.

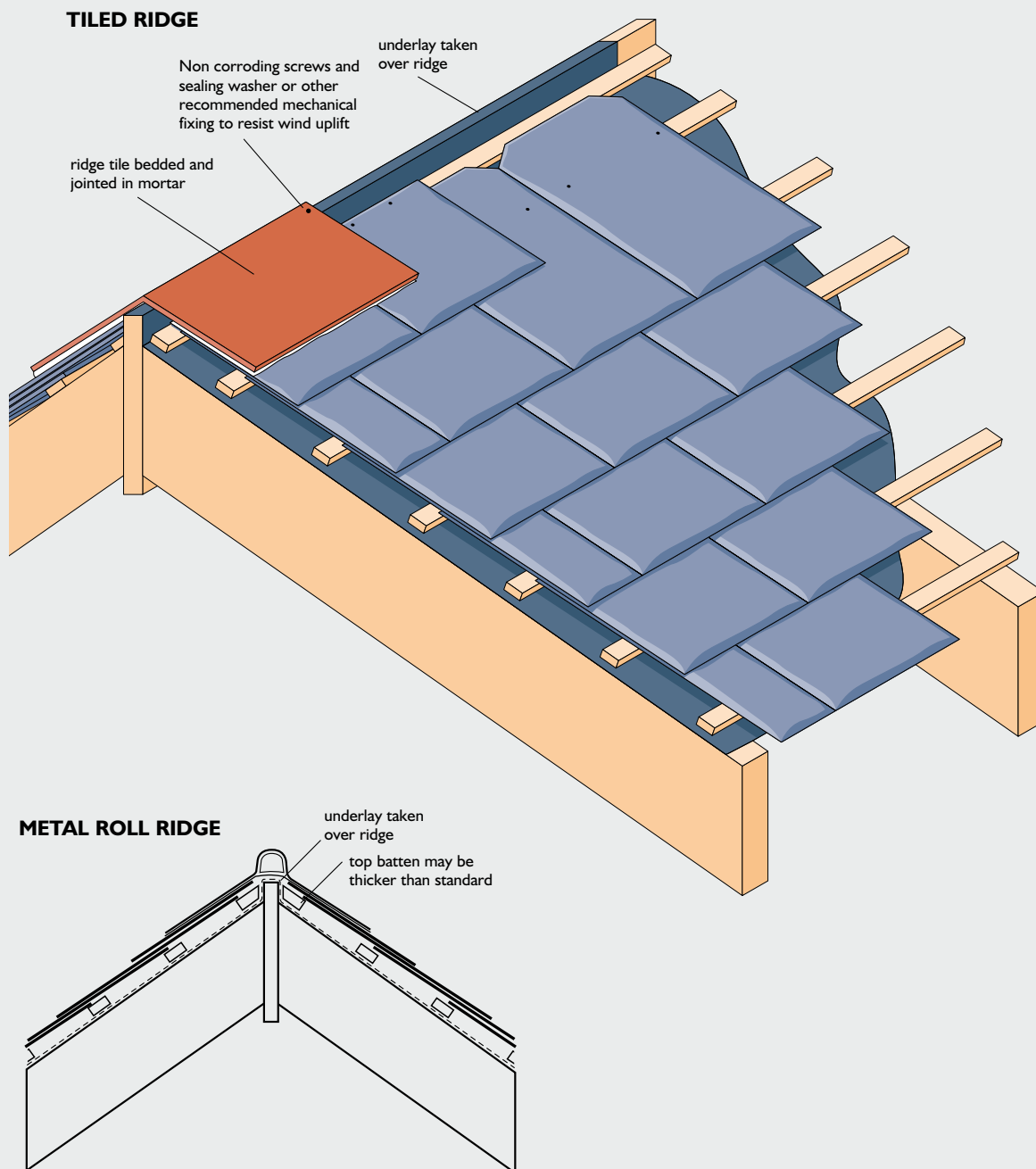

Ridges

TILED RIDGE

Lay a length of underlay over ridge to overlap general underlay by not less than 150mm. Finish slating with a head-nailed short course to maintain gauge. Make weathertight with ridge tiles laid to a true line with edges and joints solidly bedded in mortar. Provide mechanical fixing to each ridge tile (generally a screw and sealing washer fixed into ridge board or extra hip batten), and neatly strike off flush with mortar as work proceeds. Fill ends of ridges at gables with mortar and slips of slate finished flush. Mortar for bedding ridge tiles, 1:3 cement:sand pigmented to approved colour.

Where it is necessary to adjust gauges to ensure adequate ridge covering overlap, the last two courses may be cut providing that the minimum headlap is maintained.

METAL ROLL RIDGE

Code 4 or 5 lead ridge, 460 to 500mm wide, 1.5 to 1.8 metre lengths with welted joints. Lead tack 50mm wide at 150mm centres, under timber roll. Horizontal laps at 150mm.

MANSARD ROOF

CHANGE IN PITCH: GREATER THAN 150°

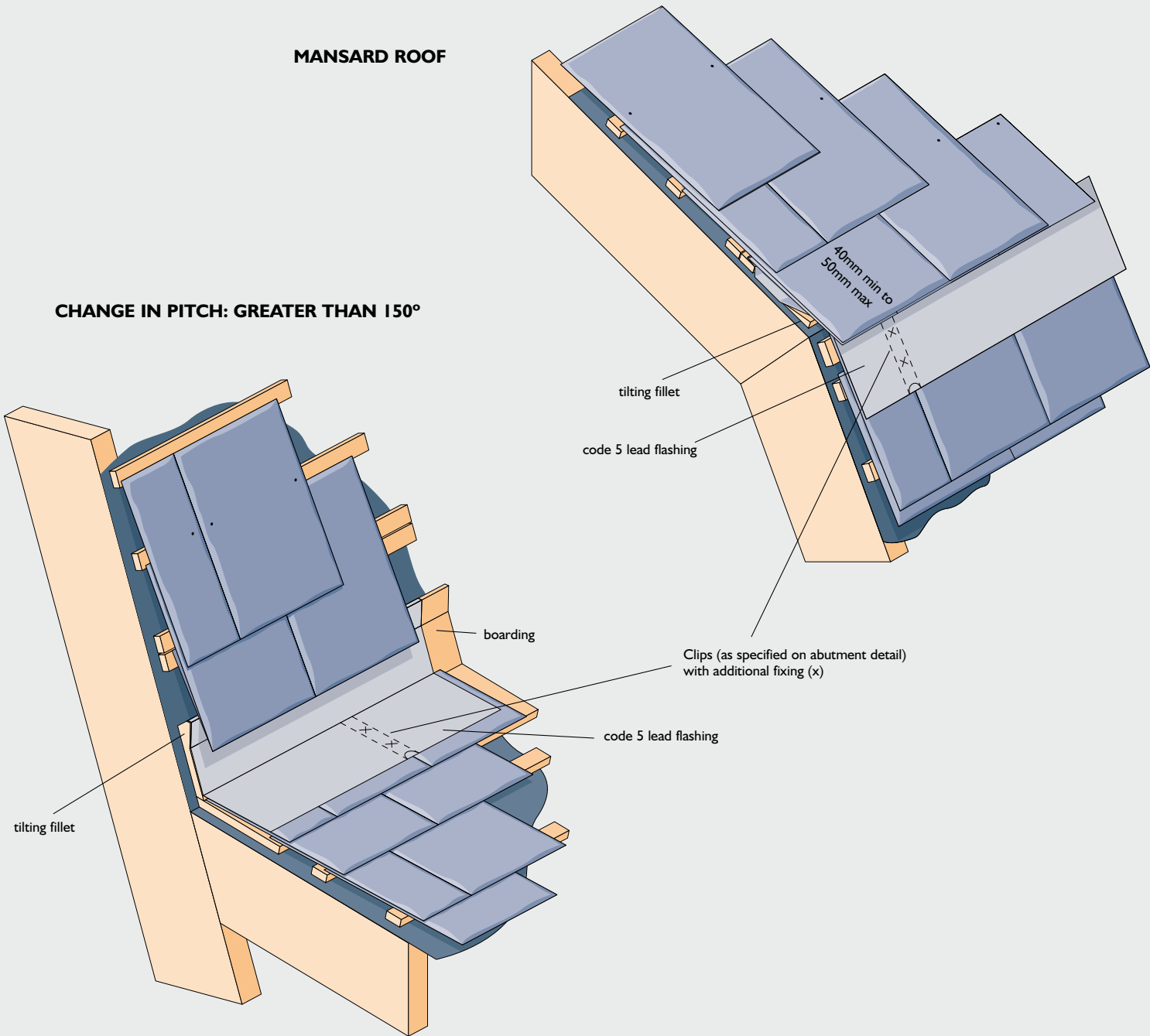

Changes in Roof Pitch



VERTICAL SLATING

Fix Welsh Slate roofing in accordance with BS 5534.

BOTTOM EDGES

Fix additional batten for under eaves course. Fix slates with tails neatly aligned. A tilting fillet should be used to support the eaves course.

TOP EDGES

Finished with head-nailed short course to maintain gauge.

ABUTMENTS

Cut slates as necessary to leave a neat 5mm gap adjacent to abutment, or use purpose-made slate-and-a-half.

ANGLES

Cut slates as necessary and interleave with lead soakers to form a neat, weathertight, close mitred junction. Fix soakers by nailing to battens at the top edge.

ROOF VERGES

Splay cut slates at ends of courses to fit closely under verge.

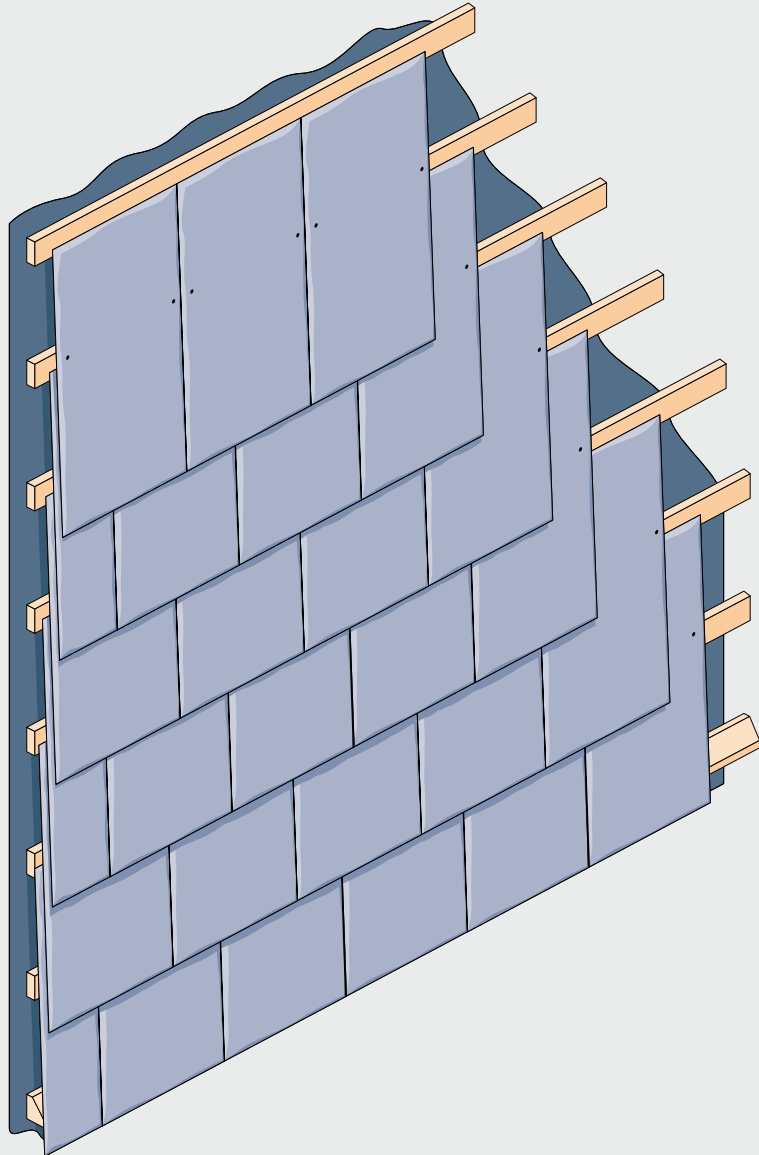

Vertical Slating



Discreet top vent unit



Bat access unit*



Roofing Ventilation

27

Building Regulation Approved Document F2 (England and Wales), Building Standards (Scotland) G4.1 and Building Regulation (Northern Ireland) C8 require that adequate provision is made in all roof voids to prevent excessive condensation.

Further guidance is also given in BS 5250 Code of Practice for the Control of Condensation in Buildings.

The most effective means of controlling harmful condensation is to provide efficient roofspace ventilation.

This can be achieved by providing eaves/low level through to ridge/high level ventilation.

Welsh Slate Ventilators have been purpose designed to provide efficient roof ventilation terminals.

These ventilators are supplied with any of our natural roofing slates as a discreet, integral, roof ventilation unit.

The Welsh Slate Ventilators can be used as roof terminals for natural ventilation and with adaptors as mechanical ventilation and soil pipe ventilation terminals.

For further information please contact the Welsh Slate Technical Department.

* Designed to allow the entry of bats into the batten cavity/roofspace. Guidance must be sought from a Bat Conservation Trust approved ecologist or from the BCT.

INSTALLATIONS

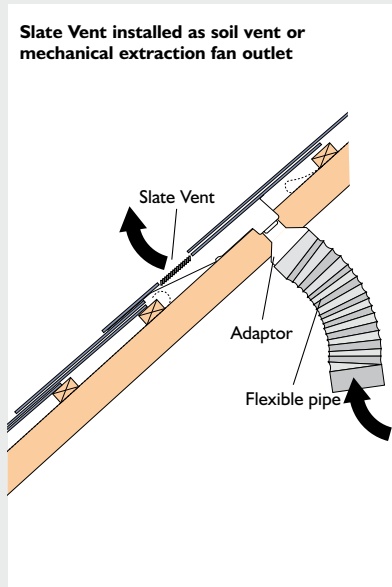
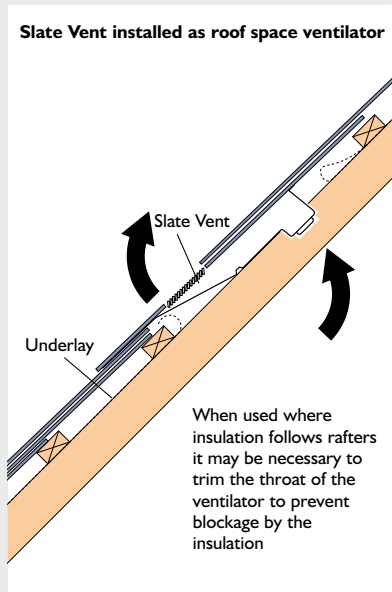

EXHAUSTING AIR TO ATMOSPHERE

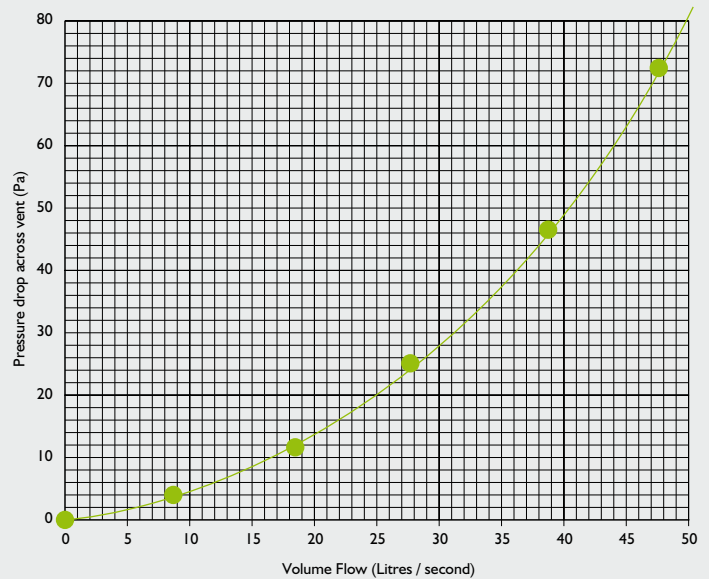

PERFORMANCE:

Nett free ventilation area:	10,000mm ²
Minimum pitch in moderate exposure:	20°
Spacing centres to achieve ventilation area of:	
5,000mm ² /metre	2.0m
10,000mm ² /metre	1.0m
Airflow resistance with pipe adaptor at:	
18 litres/second	12.0 Pascals
30 litres/second	30.0 Pascals
47 litres/second	72.0 Pascals

REFERENCES

Building Regulation Approved Document F2 'Condensation in Roofs'
 Building Regulation Approved Document H1 'Sanitary Pipework and Drainage'
 BS 5250 'Code of Practice for Control of Condensation in Buildings'
 BS 5534 'Code of Practice for Slating and Tiling',
 British Standards (Scotland) Regulations, Technical Standards for Compliance G4.1
 'Interstitial Condensation' British Regulations (Northern Ireland) C8.

Natural Slate Ventilators

BENEFITS

- Suitable for mechanical, soil pipe and natural ventilation
- Sidelap feature to accommodate angle of creep requirements
- Driving rain resistant - tested at the Building Research Establishment
- 4mm large insect grille
- Injection moulded lower tray and grille

SPECIFICATION CLAUSES:

Roofspace Ventilation
 Provide low/high level roofspace ventilation by means of a Welsh Slate Ventilator. Install at 2m or 1m centres to provide ventilation equivalent to 5,000 / 10,000mm² / metre in accordance with Building Regulations Approved Document F2 and BS 5250. Fix in accordance with manufacturers instructions.

SOIL VENT PIPE AND MECHANICAL EXTRACTION TERMINALS

Soil vent pipe stacks/mechanical extraction ducting to be terminated at the roofslope using a Welsh Slate Ventilator. Attach Welsh Slate Vent Pipe Adaptor and Flexible Pipe, ensure all joints and connections are airtight in accordance with Building Regulations Approved Document H1. Fix in accordance with manufacturers instructions. All pipes and ducts in cold roofspaces are to be insulated.



York Racecourse

Welsh Slate features prominently in the first comprehensive redevelopment of the northern end of York racecourse since the early 1900s. Some 14,000 County-grade 500mm x 300mm Penrhyn Heather Blue slates were specified by master planners Phelan Architects for the new saddling enclosure including stables, weigh-in building and “Winning connections” building. Welsh Slate floor tiles have also been used in these areas.



New Cooperage Royal William Yard, Plymouth

Welsh Slate was specified as the roofing material for the redevelopment of the former naval victualling yard. Originally dating back to between 1826 and 1835, a purpose made complex of Grade I and II buildings were constructed to ensure Royal Navy ships remained well supplied. Welsh Slate has supplied approximately 100,000 500 x 250mm Cwt Y Bugail Blue Grey roofing slates as part of the redevelopment.



Case Studies

29

German Gymnasium

A building at the heart of the redevelopment of London's Kings Cross features more than 6,000 of Welsh Slate 500mm x 300mm Cwt-Y-Bugail roof slates. They were laid above and below the Northern lights of the German gymnasium – the first purpose-built gymnasium in England and home to the indoor events of the first Olympic Games in Britain in 1866.

Ogwen Valley Visitor Centre

Roof slates were just one element of the Welsh Slate portfolio to feature on a landmark visitors' centre for Snowdonia. As well as bespoke sizes of Penrhyn Heather Blue, Dewis Architecture also specified Heather Blue floor tiles throughout the BREEAM “Excellent” Ogwen Valley visitors centre, cladding to external and internal walls, slate slab finish to external boundary walls and slate slab hardstandings.



FM 539236



FM 539237



FM 539238



BS EN 12326
KM 08014



Quality Assurance

QUALITY ASSURANCE

Welsh Slate Ltd. were the first natural slate manufacturer in the world to achieve ISO9002 accreditation to produce roofing slates satisfying BS680. The company exercises stringent quality control measures at all stages of extraction and manufacture through to delivery.



H631

Welsh Slate roofing is produced in accordance with BS EN 12326, and surpass its requirements for use in all conditions. In line with this, Welsh Slate roofing products are certified by the British Standards Institution kitemark licence, KM08014. Roofing slates produced at Penrhyn quarry are also certified by the Belgium Construction Certification Association, and carry the ATG mark. Penrhyn's ATG certificate number is H631.

Today, Welsh Slate roofing is produced in accordance with ISO9001 Quality Management System, FM539236.

INVESTORS IN PEOPLE

Welsh Slate Ltd. has been accredited as an Investor in People for the company's continuing commitment and investment in its workforce.

ENVIRONMENTAL RESPONSIBILITY

Welsh Slate Ltd. is committed to conducting our business in an environmentally responsible manner. We have a responsibility to maximise the environmental benefits, to minimise the environmental impact and to promote sustainable development within our operations and the services we provide.

Welsh Slate Ltd. operates an Environmental Management System, EMS 539237, certificated to ISO 14001.

Welsh Slate Ltd. is committed to restoring and remodelling landscapes that are affected by quarrying. Exceptionally high environmental performance standards have been achieved and are continued through development programmes that use natural materials and processes to recreate the unique character of each site.

Welsh//Slate **Customers Services**

Welsh Slate Ltd. offer the following free services:

Technical advice
Sample service
Model specification
Guide price costings
CAD drawings
RIBA Approved CPD Seminars

For all enquiries please contact

Tel: +44 (0) 1248 600656

email: enquiries@welshslate.com



ROOFING	WORKTOPS
FLOORING	AGGREGATES
PAVING	MINERALS
CLADDING	SLATEWARE
WALLING	LANDSCAPING

Welsh Slate Limited
Penrhyn Quarry
Bethesda
Bangor
Gwynedd
LL57 4YG
United Kingdom

Telephone: +44 (0) 1248 600 656
Fax: +44 (0) 1248 601 171
Website: www.welshslate.com
e-mail: enquiries@welshslate.com

Due to the limitations of reproduction and printing,
the colours of the slate shown in this brochure are
representative only.