

1.0 Assumed Sequence of Construction

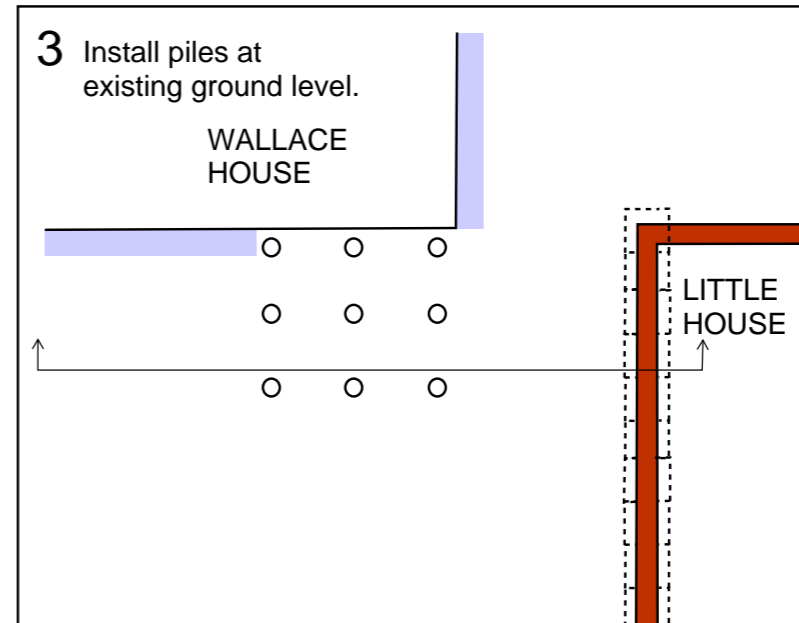

PLANS

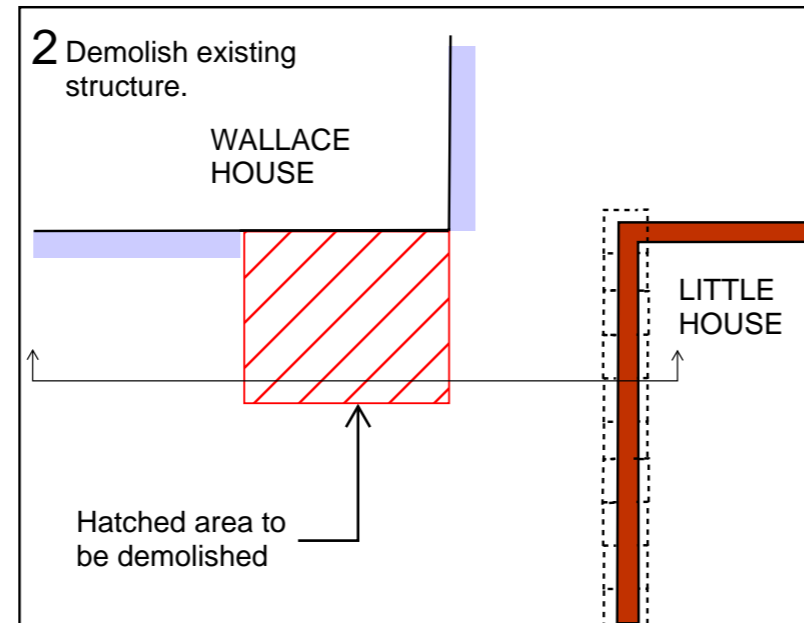
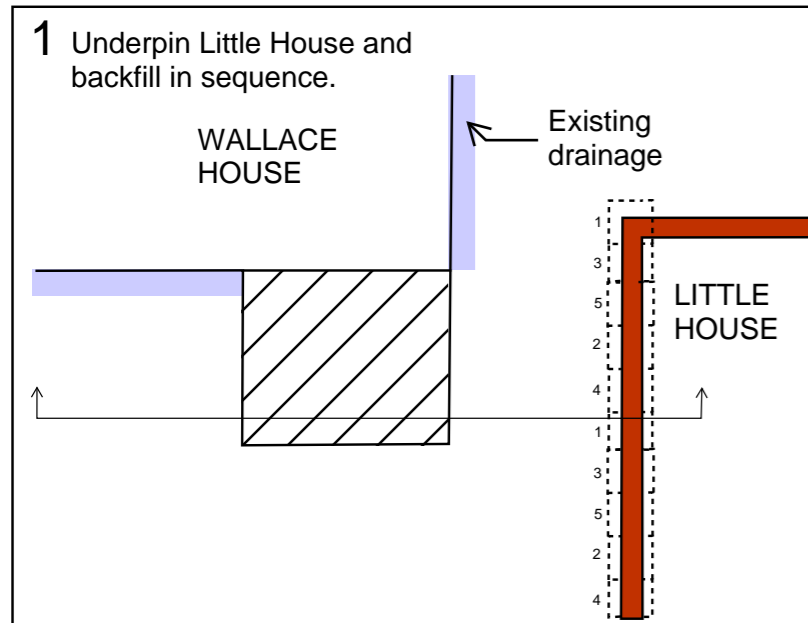
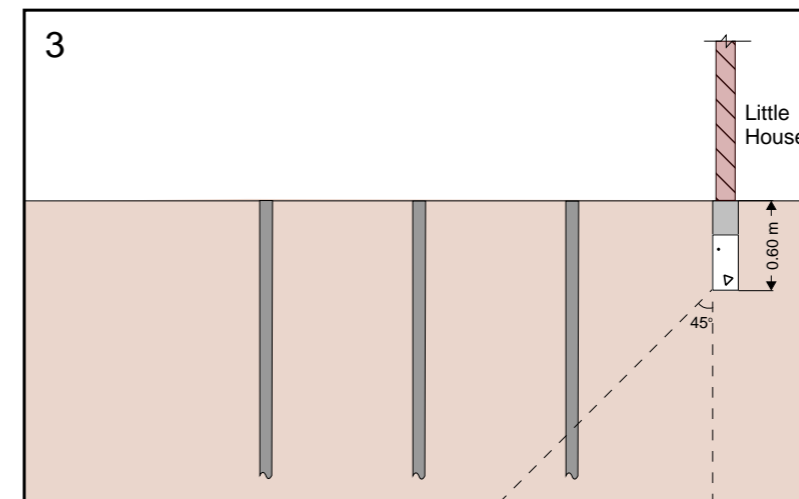
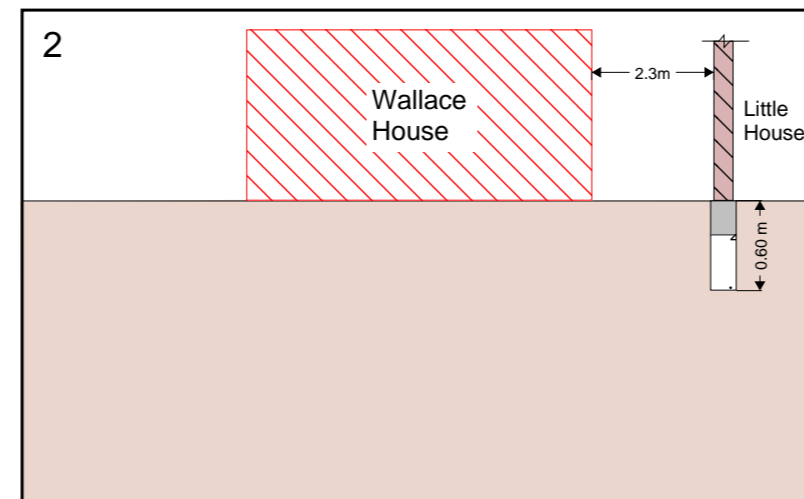
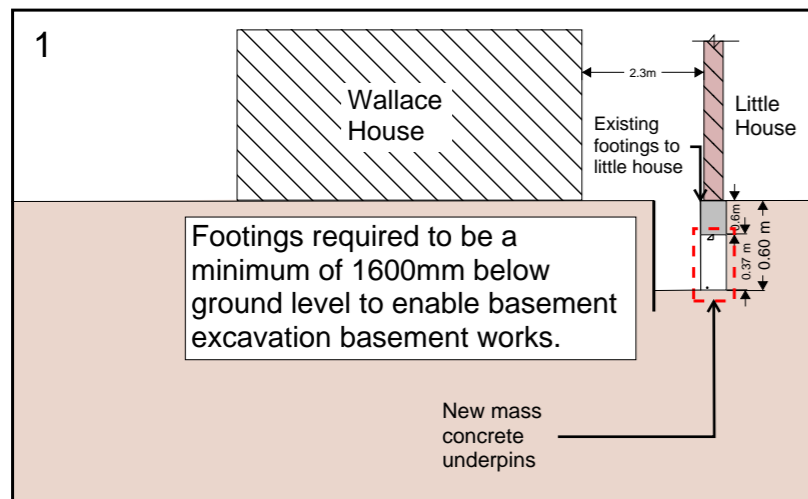

SECTIONS

P2	26/02/17	TWI	AS	Preliminary
rev	date	by	chk	description

elliottwood

Elliott Wood Partnership Ltd
 Wimbledon • Central London • Nottingham
 Consulting Structural and Civil Engineers
 tel: (020) 7499 5888. www.elliottwood.co.uk

sketch title
SUGGESTED SEQUENCE OF CONSTRUCTION
 - SHEET 1/4

SKETCH

scale (s)	date	drawn
NTS	FEB 18	TWI

project
 THE WALLACE HOUSE
 FITZROY PARK
 LONDON N6 6HT

Project no.
 2170310

Sketch no. SK/001	revision P2
----------------------	----------------

4 Batter back around portion of new basement construction at 45 degrees and cut down 6 No. piles to required excavation level.

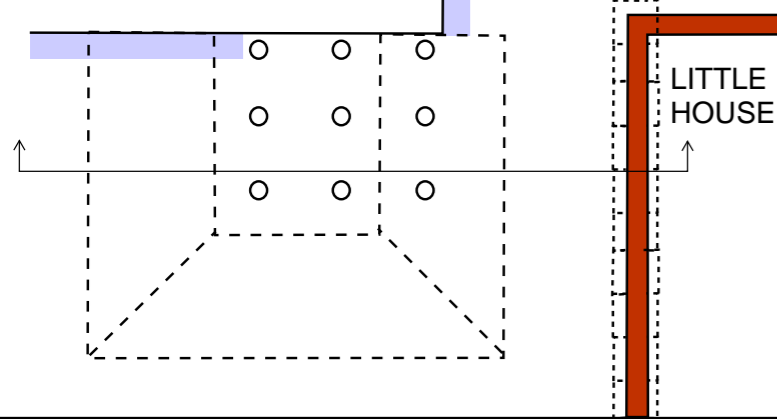

5 Construct portion of new basement structure. Install drain to the perimeter of the wall base in this area.

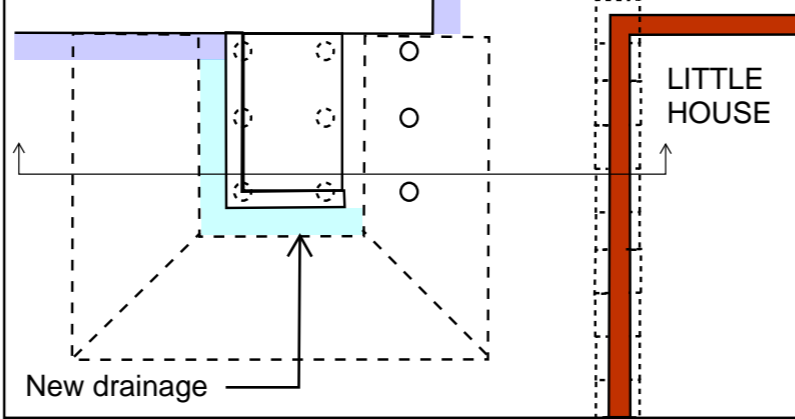

6 Install waling beam to little house foundations and prop back to newly constructed portion of basement.

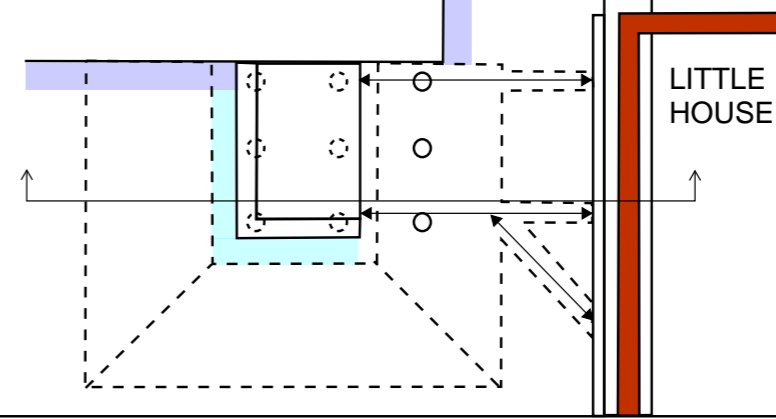

PLANS

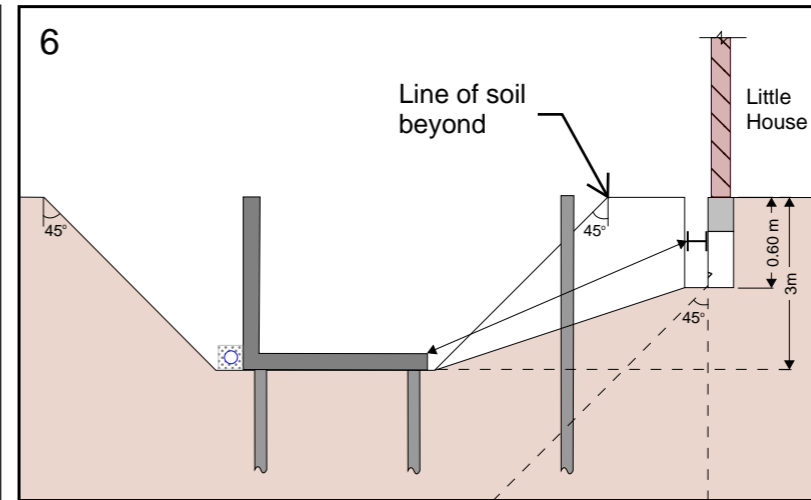
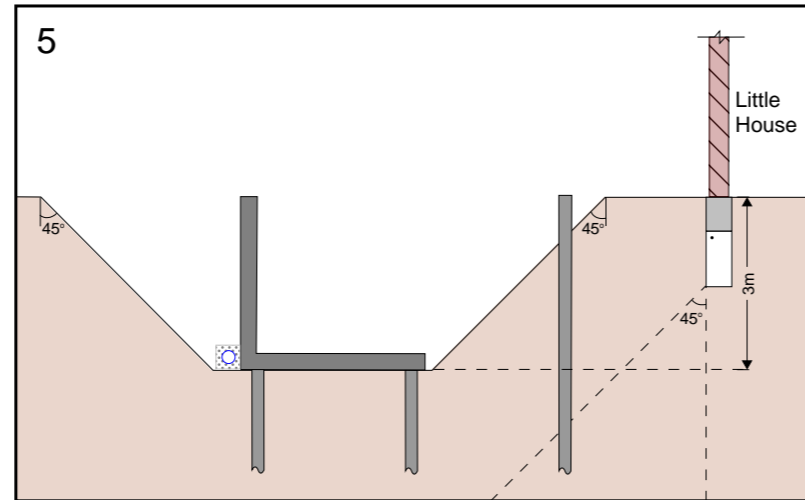
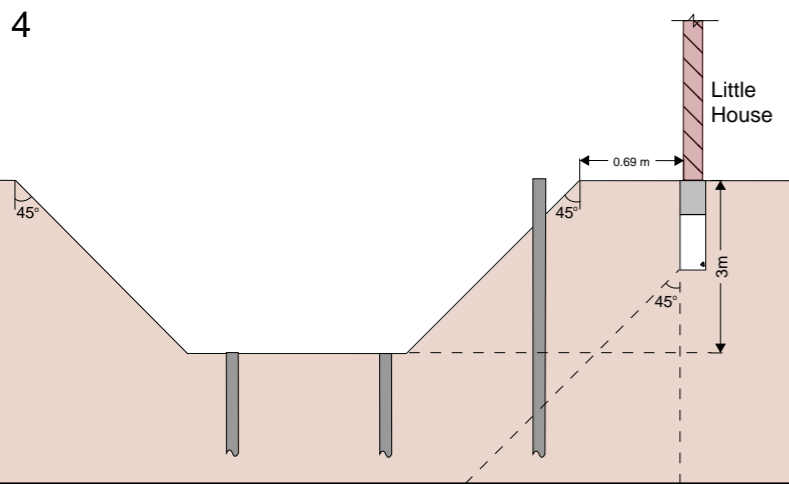

SECTIONS

P2	26/02/17	TWI	AS	Preliminary
rev	date	by	chk	description

elliottwood

Elliott Wood Partnership Ltd
 Wimbledon • Central London • Nottingham
 Consulting Structural and Civil Engineers
 tel: (020) 7499 5888. www.elliottwood.co.uk

sketch title
SUGGESTED SEQUENCE OF CONSTRUCTION
 - SHEET 2/4

SKETCH

scale (s)	date	drawn
NTS	FEB 18	TWI

project
 THE WALLACE HOUSE
 FITZROY PARK
 LONDON N6 6HT

Project no.
 2170310

Sketch no.
 SK/002

revision
 P2

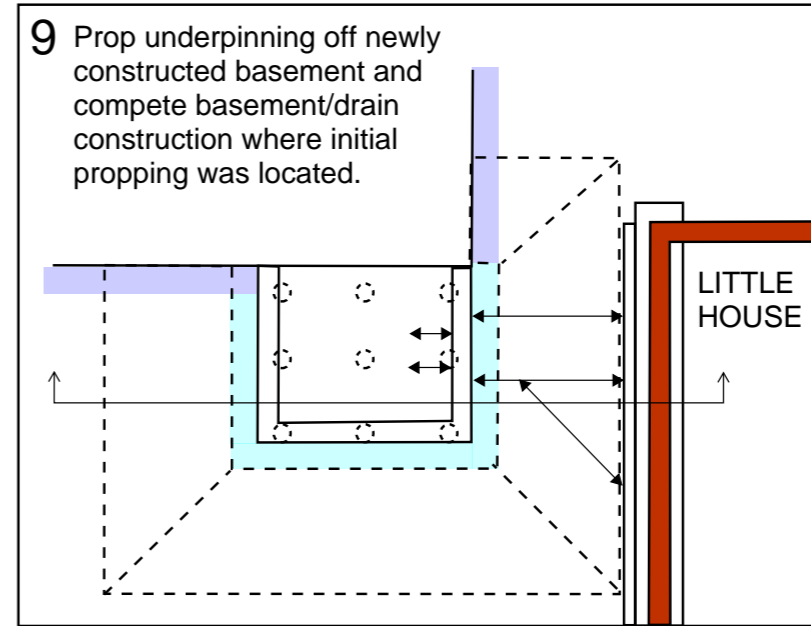
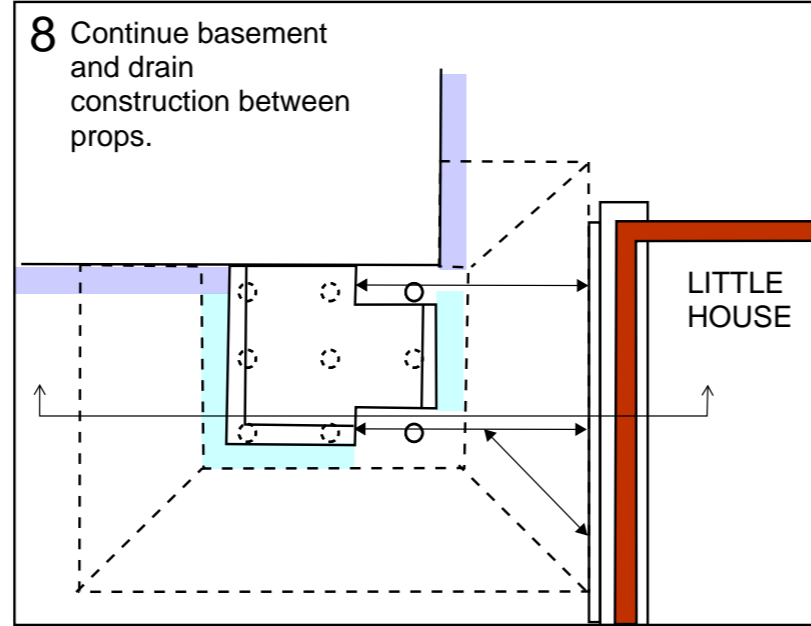
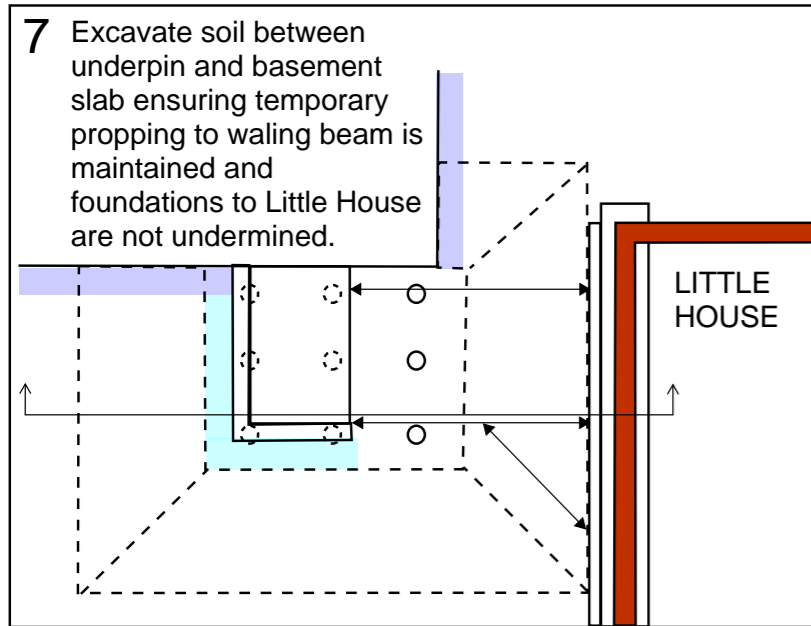

PLANS

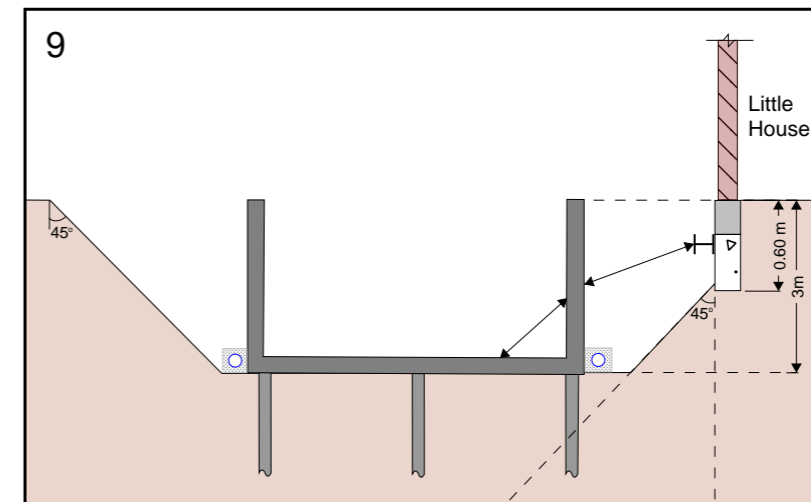
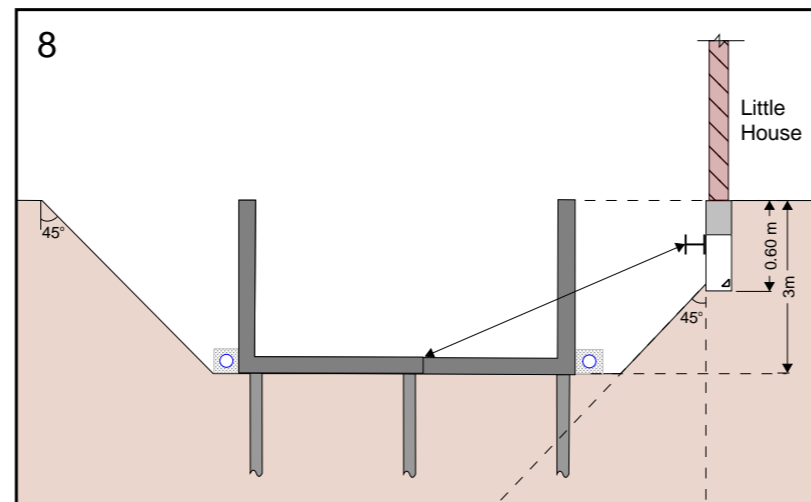
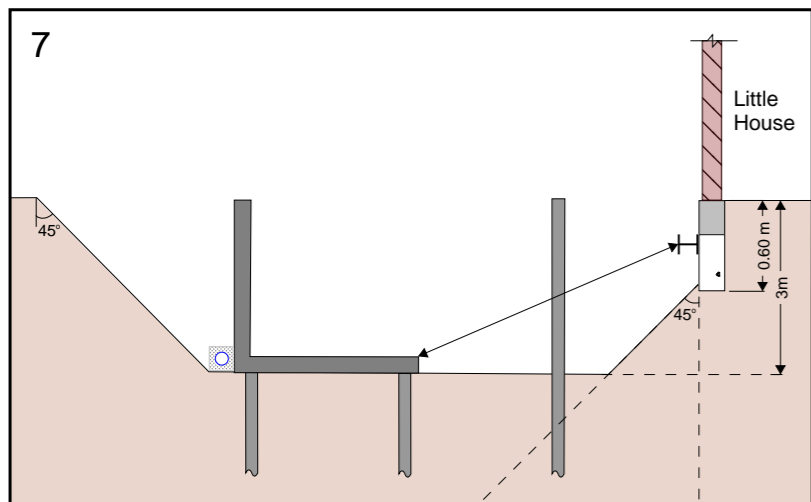

SECTIONS

P2	26/02/17	TWI	AS	Preliminary
rev	date	by	chk	description

elliottwood

Elliott Wood Partnership Ltd
 Wimbledon • Central London • Nottingham
 Consulting Structural and Civil Engineers
 tel: (020) 7499 5888. www.elliottwood.co.uk

sketch title
SUGGESTED SEQUENCE OF CONSTRUCTION
 - SHEET 3/4

SKETCH

scale (s)	date	drawn
NTS	FEB 18	TWI

project
 THE WALLACE HOUSE
 FITZROY PARK
 LONDON N6 6HT

Project no.
 2170310

Sketch no.
 SK/003

revision
 P2

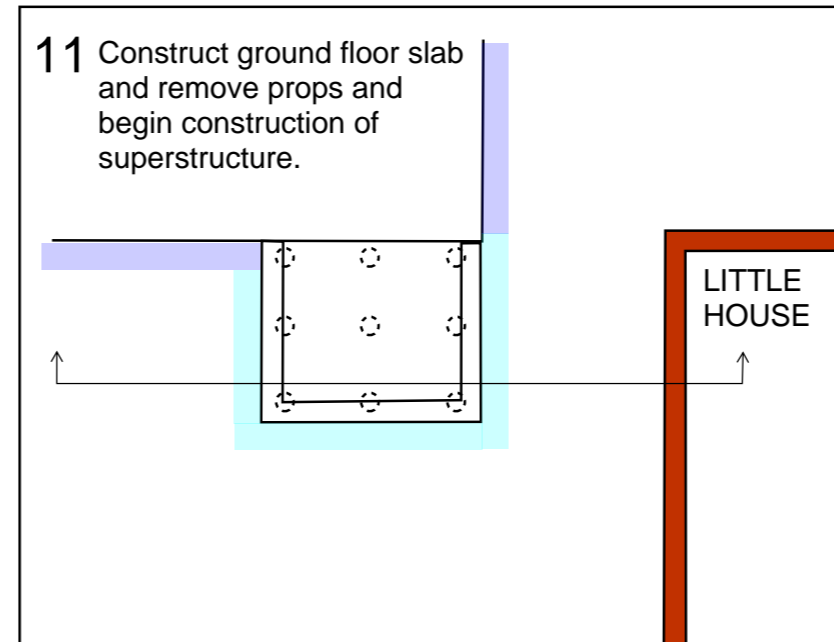
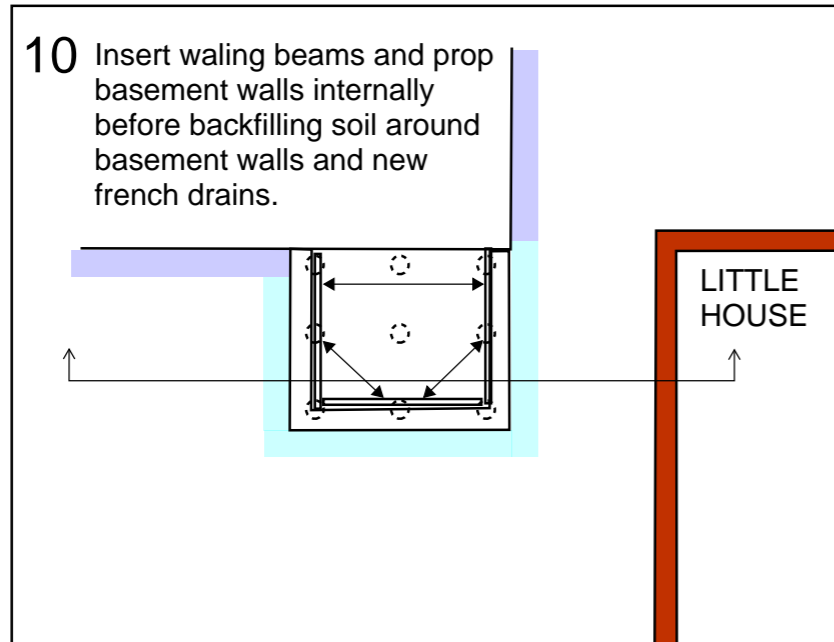

PLANS

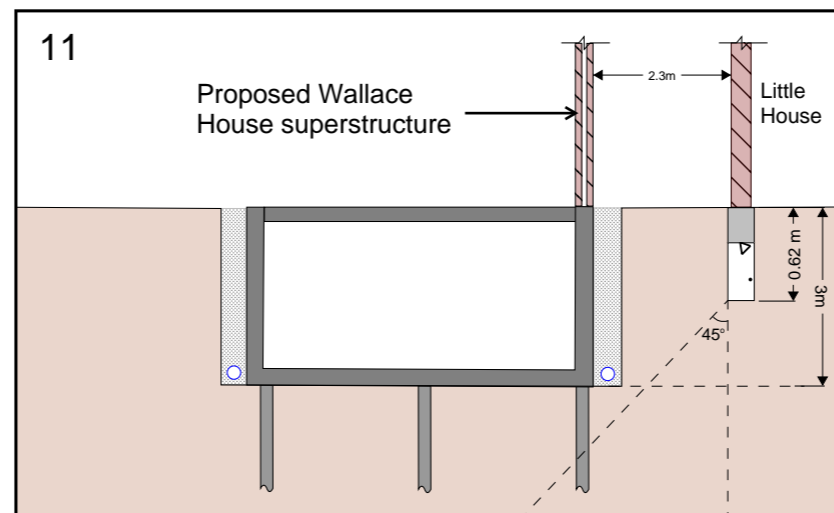
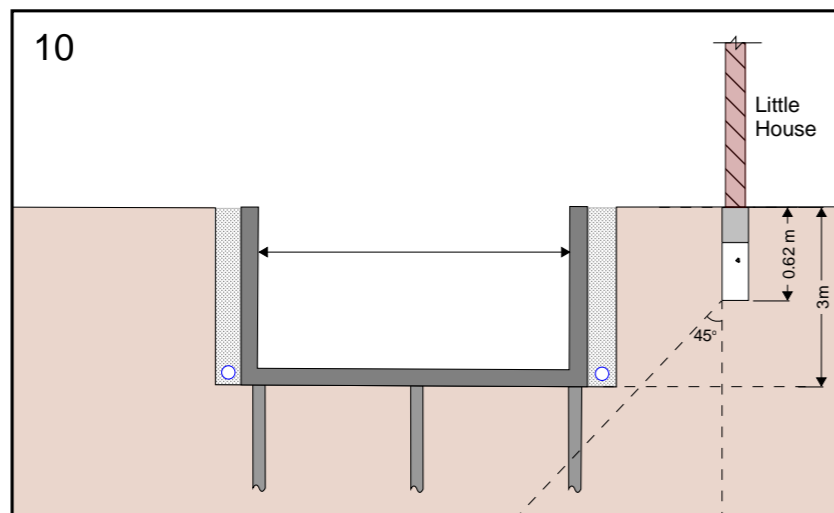

SECTIONS

P2	26/02/17	TWi	AS	Preliminary
rev	date	by	chk	description

elliottwood

Elliott Wood Partnership Ltd
 Wimbledon • Central London • Nottingham
 Consulting Structural and Civil Engineers
 tel: (020) 7499 5888. www.elliottwood.co.uk

sketch title
SUGGESTED SEQUENCE OF CONSTRUCTION
 - SHEET 4/4

SKETCH

scale (s)	date	drawn
NTS	FEB 18	TWi

project
 THE WALLACE HOUSE
 FITZROY PARK
 LONDON N6 6HT

Project no.
 2170310

Sketch no. SK/004	revision P2
----------------------	----------------