

Camden Planning Guidance

# Design

London Borough of Camden

CPG **1**



July 2015



# CPG1 Design

1	Introduction.....	5
2	Design excellence .....	9
3	Heritage.....	15
4	Extensions, alterations and conservatories.....	25
5	Roofs, terraces and balconies .....	35
6	Landscape design and trees.....	45
7	Shopfronts.....	57
8	Advertisements, signs and hoardings .....	73
9	Designing safer environments .....	79
10	Recycling and Waste Storage .....	89
11	Building services equipment.....	97
12	Artworks, statues and memorials.....	101



# 1 Introduction

## What is Camden Planning Guidance?

- 1.1 We have prepared this Camden Planning Guidance to support the policies in our Local Development Framework (LDF). This guidance is therefore consistent with the Core Strategy and the Development Policies, and forms a Supplementary Planning Document (SPD) which is an additional “material consideration” in planning decisions. The Council adopted CPG1 Design on 6 April 2011 following statutory consultation. This document was updated in 2013 to include Section 12 on artworks, statues and memorials, and updated in 2015 to revise the guidance for recycling and waste storage. Details on these updates and the consultation process are available at [camden.gov.uk/cpg](http://camden.gov.uk/cpg).
- 1.2 The Camden Planning Guidance covers a range of topics (such as housing, sustainability, amenity and planning obligations) and so all of the sections should be read in conjunction, and within the context of Camden’s LDF.

## Design in Camden

- 1.3 Camden has many attractive and historic neighbourhoods as well as both traditional and modern buildings of the highest quality. These are a significant reason that the borough is such a popular place to live, work and visit. As well as conserving our rich heritage we should also contribute towards it by ensuring that we create equally high quality buildings and spaces which will be appreciated by future generations.
- 1.4 This objective of achieving high quality design does not just concern new development or large-scale schemes, but also includes the replacement, extension or conversion of existing buildings. The detailed guidance contained within this section therefore considers a range of design-related issues for both residential and commercial property and the spaces around them.



## What does this guidance cover?

1.5 This guidance provides information on all types of detailed design issues within the borough and includes the following sections:

1. Introduction
2. Design excellence
3. Heritage
4. Extensions, alterations and conservatories
5. Roofs, terraces and balconies
6. Landscape design and trees
7. Shopfronts
8. Advertisements, signs and hoardings
9. Designing safer environments
10. Waste recyclables storage
11. Building services equipment
12. Artworks, statues and memorials

1.6 This guidance supports the following Local Development Framework policies:

### Core Strategy

- CS14 Promoting high quality places and conserving our heritage
- CS15 Protecting and improving our parks and open spaces & encouraging biodiversity
- CS17 Making Camden a safer place
- CS18 Dealing with our waste and encouraging recycling

### Development Policies

- DP24 Securing high quality design
- DP25 Conserving Camden's heritage
- DP27 Basements and lightwells
- DP29 Improving access
- DP30 Shopfronts

1.7 It should be noted that the guidance covered in this section only forms part of the range of considerations that you should address when proposing new development. In addition to these specific design matters you should also consider wider issues such as cycle storage, residential space standards, wheelchair housing, designing in sustainability measures and impacts on neighbours. Further guidance on these, and other issues, is contained within the Local Development Framework documents and the Camden Planning Guidance.





## 2 Design excellence

### KEY MESSAGES

Camden is committed to excellence in design and schemes should consider:

- The context of a development and its surrounding area;
- The design of the building itself;
- The use of the building;
- The materials used; and
- Public spaces.

- 2.1 High quality design makes a significant contribution to the success of a development and the community in which it is located. Design of the built environment affects many things about the way we use spaces and interact with each other, comfort and enjoyment, safety and security and our sense of inclusion.
- 2.2 The purpose of this guidance is to promote design excellence and to outline the ways in which you can achieve high quality design within your development.
- 2.3 This guidance primarily relates to Core Strategy Policy CS14 Promoting high quality places and conserving our heritage and Development Policies DP24 Securing high quality design.



### When does this apply?

- 2.4 This guidance applies equally to all development, whether new build, converted, refurbished, extended and altered development. However, the implications for a proposal will vary greatly depending on the nature of the site, the proposed use, the scale of development, its interaction with surrounding sites, and existing buildings and structures on the site.

- 2.5 Other sections in this Camden Planning Guidance (CPG) relate to specific types of developments and relevant design matters, for example advertisements, signs and hoardings, designing safer environments, extensions, alterations and conversions, heritage and shopfronts.

### **General guidance on design**

- 2.6 Camden is committed to excellence in design. The borough contains many special and unique places, many of which are protected by conservation area status. In accordance with draft London Plan policies 7.1–7.7, Core Strategy policy CS14 requires development schemes to improve the quality of buildings, landscaping and public spaces and we will not approve design which is inappropriate to its context or fails to improve the character of an area.
- 2.7 We are working with our partners to promote design excellence and improve public buildings, landscaping and the street environment. We have established the Camden Design Initiative which seeks to encourage involvement, awareness and understanding of good design and this is promoted through the bi-annual Camden Design Awards which acknowledge high quality and innovative design. We are also a promoter of the national Civic Trust Awards which are awarded to buildings judged to have made a positive cultural, social or economic contribution to the local community.
- 2.8 In order to achieve high quality design in the borough we require applicants to consider buildings in terms of context, height, accessibility, orientation, siting, detailing and materials. These issues apply to all aspects of the development, including buildings and other structures (e.g. substations, refuse or cycle storage), outdoor spaces, landscaping and access points and should be considered at an early stage in the design of a development, as these elements are often difficult to change in later stages.



## **Context**

### 2.9 Good design should:

- positively enhance the character, history, archaeology and nature of existing buildings on the site and other buildings immediately adjacent and in the surrounding area, and any strategic or local views. This is particularly important in conservation areas;
- respect, and be sensitive to, natural and physical features, both on and off the site. Features to be considered include, but are not limited to: slope and topography, vegetation, biodiversity, habitats, waterways and drainage, wind, sunlight and shade, and local pollutant sources. Movement of earth to, from and around the site should be minimised to prevent flood risk, land instability and unnecessary transport of aggregates, especially by road; and
- consider connectivity to, from, around and through the site for people using all modes of transport, including pedestrians, cyclists, wheelchair users, those with visual impairments, people with pushchairs, and motorised vehicles.

## **Building design**

### 2.10 Good design should:

- ensure buildings do not significantly overshadow existing/proposed outdoor spaces (especially designated open spaces), amenity areas or existing or approved renewable energy facilities (such as solar panels). For further information, refer to CPG3 Sustainability Renewable energy (A shadowing exercise may be required for tall buildings or where they are near open spaces);
- consider the extent to which developments may overlook the windows or private garden area of another dwelling;
- consider views, both local and London wide, and particularly where the site is within a recognised strategic viewing corridor (as shown on the policy Proposals Map);
- consider the degree of openness of an area and of open spaces, including gardens including views in and out of these spaces
- contributions to the character of certain parts of the borough;
- provide visual interest for onlookers, from all aspects and distances. This will involve attention to be given to both form and detail;
- consider opportunities for overlooking of the street and, where appropriate, provide windows, doors and other 'active' features at ground floor; and
- incorporate external facilities such as renewable energy installations, access ramps, plant and machinery, waste storage facilities and shading devices into the design of the development. Careful consideration must be given to ensure that the facility does not harm the built environment.

### **Land use**

- 2.11 The use of a building should:
- take into account the proposed use, and the needs of the expected occupants of the buildings and other users of the site and development; and
  - provide clear indication of the use of the building. It is noted, however, that reuse of existing buildings, as well as the accommodation of possible future changes of use, can make this difficult.

### **Materials**

- 2.12 Materials should form an integral part of the design process and should relate to the character and appearance of the area, particularly in conservation areas or within the setting of listed buildings. The durability of materials and understanding of how they will weather should be taken into consideration. The quality of a well designed building can be easily reduced by the use of poor quality or an unsympathetic palette of materials. We will encourage re-used and recycled materials, however these should be laid to ensure a suitable level accessible surface is provided. Further guidance is contained within CPG3 Sustainability (Sustainable use of materials).

### **Tall buildings**

- 2.13 Tall buildings in Camden (i.e. those which are substantially taller than their neighbours and/or which significantly change the skyline) will be assessed against a range of design issues, including:
- how the building relates to its surroundings, both in terms of how the base of the building fits in with the streetscape, and how the top of a tall building affects the skyline;
  - the contribution a building makes to pedestrian permeability and improved public accessibility;
  - the relationship between the building and hills and views;
  - the degree to which the building overshadows public spaces, especially open spaces and watercourses; and
  - the historic context of the building's surroundings.
- 2.14 In addition to these design considerations tall buildings will be assessed against a range of other relevant policies concerning amenity, mixed use and sustainability. Reference should be made to this CPG (Heritage chapter), CPG3 Sustainability (Climate change adaptation chapter) and CPG6 Protecting and improving quality of life (Overlooking and privacy and Wind/microclimate chapters).
- 2.15 Where a proposal includes a development that creates a landmark or visual statement, particular care must be taken to ensure that the location is appropriate (such as a particular destination within a townscape, or a particular functional node) and that the development is sensitive to its wider context. This will be especially important where the

development is likely to impact upon heritage assets and their settings (including protected views).

- 2.16 Design should consider safety and access. Guidance on these issues is contained within this CPG (Designing safer environments chapter) and CPG4 Protecting and improving quality of life (Access for all chapter). Schemes over 90m should be referred to the Civil Aviation Authority.

### **Design of public space**

- 2.17 The design of public spaces, and the materials used, is very important. The size, layout and materials used in the spaces around buildings will influence how people use them, and help to create spaces that are welcoming, attractive, accessible, safe and useful. They can also contribute to other objectives such as reducing the impact of climate change (e.g. the use of trees and planters to reduce run-off and provide shading), biodiversity, local food production and Sustainable Urban Drainage Systems (SUDs), and provide useful amenity space. In Conservation Areas there may be particular traditional approaches to landscaping/boundary treatments that should be respected in new designs.
- 2.18 The spaces around new developments should be considered at the same time as the developments themselves and hard / soft landscaping and boundary treatments should be considered as part of wider cohesive design. The landscaping and trees chapter in this CPG, and individual Conservation Area Appraisals, provide further guidance on this issue.
- 2.19 Public art can be a catalyst for improved environmental quality by upgrading and animating public space and enhancing local character and identity through helping create a sense of place. The Council will therefore encourage the provision of art and decorative features as an integral part of public spaces, where they are appropriate to their location and enhance the character and environment.
- 2.20 It is important that public spaces and streets are maintained to a high standard and so, in line with the Local Implementation Plan, the Council will continue to undertake public space enhancement works through specifically targeted programmes. The Designing safer environments chapter in this CPG provides more detailed guidance on the incorporation of safety and security considerations in public spaces.

### **Design and access statements**

- 2.21 Design and Access Statements are documents that explain the design ideas and rationale behind a scheme. They should show that you have thought carefully about how everyone, including disabled people, older people and children, will be able to use the places you want to build.
- 2.22 Design and Access Statements should include a written description and justification of the planning application and sometimes photos, maps and drawings may be useful to further illustrate the points made. The length

and detail of a Design and Access Statement should be related to the related to the size and complexity of the scheme. A statement for a major development is likely to be much longer than one for a small scheme.

- 2.23 Design and Access Statements are required to accompany all planning, conservation and listed building applications, except in certain circumstances as set out on our website [www.camden.gov.uk/planning](http://www.camden.gov.uk/planning). Our website also provides a template for Design and Access Statements and lists the information that each statement should contain. Further guidance on Access Statements is provided in CPG4 Protecting and improving quality of life (Access for all chapter).

### Further information

General	By Design: Urban Design in the Planning System – Towards Better Practice, DETR/CABE, 2000 Design and Access Statements; how to read, write and use them, CABE, 2007
Tall Buildings	Guidance on tall buildings, English Heritage/CABE, 2007
Historic Environment	Understanding Place: conservation areas designation, appraisal and management (2011) Building in Context, English Heritage/CABE, 2002. Seeing History in the View (2011) Good Practice Advice 3- Settings and Views (2015)
Other	Royal Institute of Chartered Surveyors (RICS); and Royal Institute of British Architects (RIBA).



## 3 Heritage

### KEY MESSAGES

Camden has a rich architectural heritage and we have a responsibility to preserve, and where possible, enhance these areas and buildings.

- We will only permit development within conservation areas that preserves and enhances the character and appearance of the area
- Our conservation area statements, appraisals and management plans contain more information on all the conservation areas
- Most works to alter a listed building are likely to require listed building consent
- Historic buildings can and should address sustainability and accessibility

3.1 This section provides guidance on our identified heritage assets (which include conservation areas, listed buildings and registered parks and gardens), including what they area and the implications of their status and designation. This section also sets out details on how historic buildings can address sustainability.

3.2 This section sets out further guidance on how we will apply Core Strategy Policy CS14 Promoting high quality places and conserving our heritage and Development Policy DP25 Conserving Camden's Heritage.

### When does this apply?

3.3 This guidance applies to all applications which may affect any element of the historic environment and therefore may require planning permission, or conservation area or listed building consent.

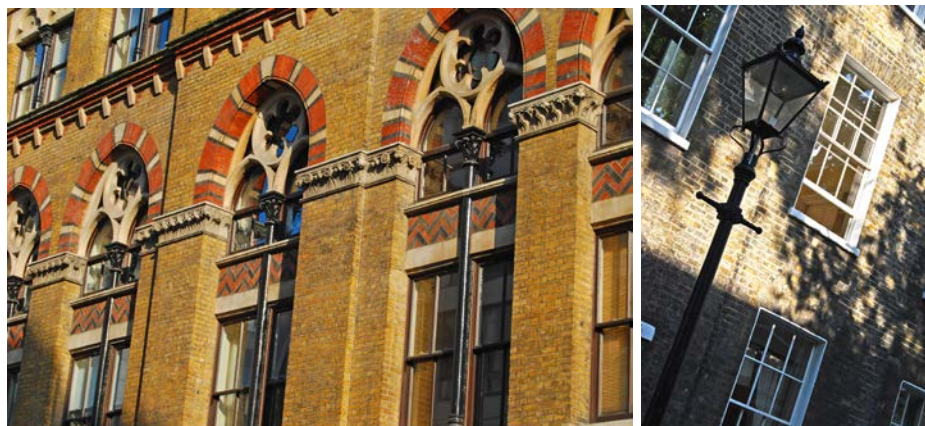

## Conservation Areas

### What is a conservation area?

- 3.4 A conservation area is defined in the Planning (Listed Buildings and Conservation Areas) Act 1990 as an area of special architectural or historic interest, the character or appearance of which it is desirable to preserve and, where possible, enhance. PPS5 identifies conservation areas as “heritage assets” and requires that proposals in conservation areas are assessed for their impacts on their historic significance. There are 39 conservation areas in Camden, which vary greatly in appearance, size, character and style and these are identified on the LDF Proposals Map.



Figure 1. Conservation Areas

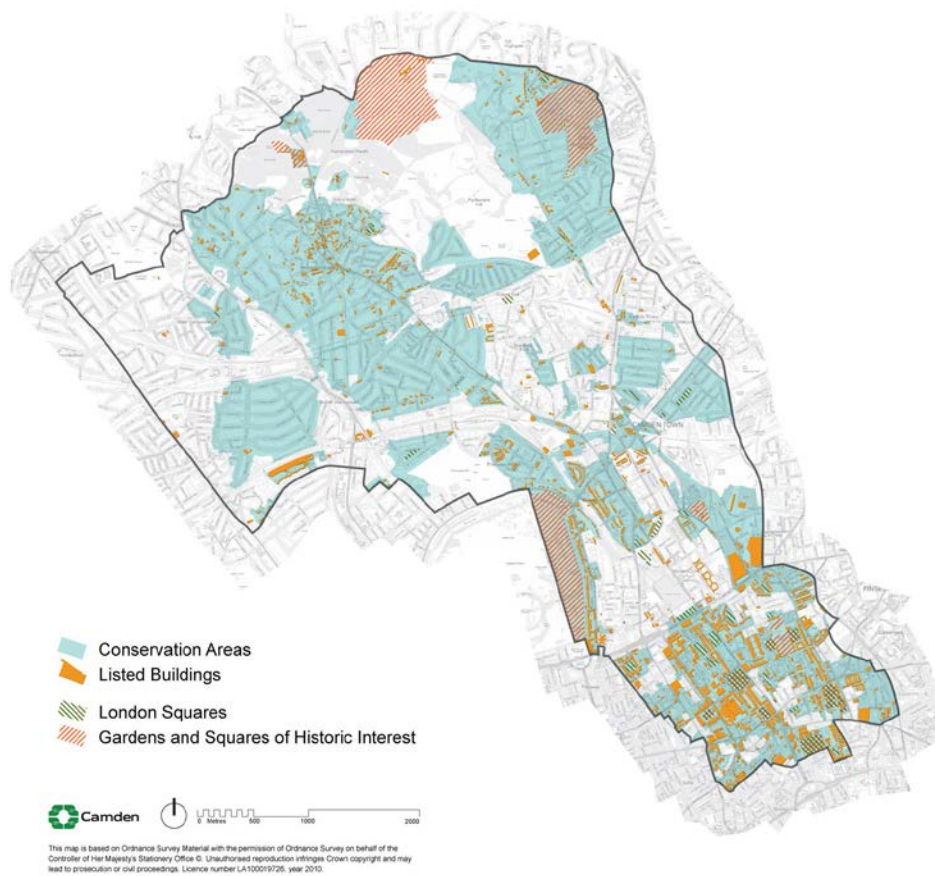

- 3.5 Conservation area designation is a way to recognise the importance of the quality of an area as a whole, as well as giving some protection to individual buildings within it. Conservation areas are not designated to stop all future development or change but to ensure that change is managed to conserve the historic significance of the area as a whole.
- 3.6 Conservation area designation is shown on the proposals map and further information on heritage is available on the 'Conservation and Design' section of the Council's website [www.camden.gov.uk](http://www.camden.gov.uk) and on English Heritage's website [www.english-heritage.org.uk](http://www.english-heritage.org.uk).

#### Effects of conservation area status

- 3.7 We will only permit development within conservation areas, and development affecting the setting of conservation areas, that preserves and enhances the character and appearance of the area (see Planning Policy Statement 5 (PPS5), policy HE8).
- 3.8 The Council has greater control over building work in conservation areas, including demolition, materials and detailed design. Planning permission may be required for alterations or extensions that would not normally need planning permission elsewhere, such as minor roof

alterations, dormer windows, renewable energy installations or installation of a satellite dish.

#### **Renewable energy technology**

Renewable energy technologies generate energy from natural resources such as sunlight, wind, rain and heat in the ground, which are naturally replenished.

### **Demolition in conservation areas**

- 3.9 Conservation Area Consent is required to demolish or substantially demolish a building over 115 cubic metres or a structure such as a wall over 1 metre high that adjoins a highway, or more than 2 metres high elsewhere. When determining your application we will follow the guidance in PPS5, Core Strategy policy CS14 and Development Policy DP24 as well as that in our conservation area statements, appraisals and management plans (see below). It is an offence to totally or substantially demolish a building or structure in a conservation area without first getting consent from us and we would not normally allow their demolition without substantial justification, in accordance with criteria set out in government guidance PPS5 – Planning for the Historic Environment.

### **Trees**

- 3.10 Planning legislation makes special provision for trees in conservation areas. Prior to pruning or felling a tree in a conservation area you must provide the Council six weeks notice in writing. All trees that contribute to the character and appearance of a conservation area should be retained and protected. For further information on trees, please see Landscape Design and Trees chapter in this CPG.



### **Article 4 directions**

- 3.11 A range of minor changes can be made to buildings without the need to apply for planning permission as these have a general permission through planning legislation. These changes are known as permitted development. However, the character of a conservation area depends on the presence of specific original details and where these are lost the historic interest and attractive character of the area deteriorates.

- 3.12 In these situations we can issue an Article 4 direction through Article 4 of the Town and Country Planning (General Permitted Development) Order 1995 (as amended). This removes permitted development rights and means a planning application has to be made for minor works that usually do not need one.
- 3.13 Further information on Article 4 directions, including where they apply in Camden is available on the 'Advice and help with planning applications' section of the Council's website [www.camden.gov.uk](http://www.camden.gov.uk) and English Heritage has published Guidance on making Article 4 Directions, available at [www.english-heritage.org.uk/publications/guidance-on-making-article-4-directions/](http://www.english-heritage.org.uk/publications/guidance-on-making-article-4-directions/)

### **Conservation area statements, appraisals and management plans**

- 3.14 We have published a series of conservation area statements, appraisals and management plans that set out our approach to preserving and enhancing the historic significance of each individual conservation area. Many of these conservation area statements are available for download on our website.
- 3.15 Conservation area statements, appraisals and management plans help guide the design of development in conservation areas and we take these into account when assessing planning applications.
- 3.16 Each conservation area statement, appraisal or management plan contains the following:
- A summary of the location and the historical development of an area;
  - A description of its character;
  - An outline of the key issues and development pressures that are currently of concern;
  - The key policy framework for that particular conservation area, and specific guidance for it;
  - An identification of heritage assets and elements of the wider historic environment which give an area its historic significance; and
  - An identification of sites and features that have a negative impact on the conservation area, or where an opportunity exists for enhancement of the area by redevelopment of a building or site.



## Listed Buildings

### What is a listed building?

- 3.17 A listed building is defined in the Planning (Listed Buildings and Conservation Areas) Act 1990 as a structure or building of special architectural or historic interest. These are included on the Statutory List of Buildings of Architectural or Historic Interest managed by English Heritage. Listed buildings are identified as heritage assets within the LDF and the Council is required to assess the impact that proposals to a listed building, or within their setting, may have on the historic significance of the building.
- 3.18 Listed buildings are graded according to their relative importance as either Grade I, Grade II\* or Grade II. Grades I and II\* are considered of outstanding architectural or historic interest and are of particularly great importance to the nation's heritage. The majority of listed buildings (about 94% nationally) are Grade II. However, the statutory controls on alterations apply equally to all listed buildings irrespective of their grade and cover the interior as well as the exterior and any object or structure fixed to or within their curtilage.

#### **Listing description**

The listing description contains details of a listed building's address, history, appearance and significance. These help to identify what it is about the building that gives it its special historic interest.

- 3.19 Further information on listed buildings in Camden is available on our website [www.camden.gov.uk](http://www.camden.gov.uk)

### How can I alter a listed building?

- 3.20 Most works to alter a listed building are likely to require listed building consent and this is assessed on a case by case basis, taking into



account the individual features of a building, its historic significance and the cumulative impact of small alterations. The listing description is not intended to be exhaustive and the absence of any particular feature in the description does not imply that it is not of significance, or that it can be removed or altered without consent. Listed status also extends to any object or structure fixed to the listed building, and any object or structure within its curtilage which forms part of the land. You should contact the Council at the earliest opportunity to discuss proposals and to establish whether listed building consent is required.

- 3.21 Some 'like for like' repairs and maintenance do not require listed building consent. However, where these would involve the removal of historic materials or architectural features, or would have an impact on the special architectural or historic interest of the building, consent will be required. If in doubt applicants should contact the Council for advice.
- 3.22 In assessing applications for listed building consent we have a statutory requirement to have special regard to the desirability of preserving the building or its setting or any features of special architectural or historic interest which it possesses. We will consider the impact of proposals on the historic significance of the building, including its features, such as:
- original and historic materials and architectural features;
  - original layout of rooms;
  - structural integrity; and
  - character and appearance.
- 3.23 We will expect original or historic features to be retained and repairs to be in matching material. Proposals should seek to respond to the special historic and architectural constraints of the listed building, rather than significantly change them.
- 3.24 Applications for listed building consent should be fully justified and should demonstrate how proposals would affect the significance of a listed building and why the works or changes are desirable or necessary. In addition to listed building consent, some proposals may also require planning permission. These applications should be submitted together and will be assessed concurrently.
- 3.25 It is a criminal offence to undertake unauthorised works to a listed building, even if you are not aware the building is listed, and could result in prosecution and fine or imprisonment (or both).
- 3.26 Some works that are required in order to comply with the Building Regulations (e.g. inclusive access, energy efficiency) may have an impact on the historic significance of a listed building and will require listed building consent.

### **Inclusive access to listed buildings**

- 3.27 It is important that everyone should have dignified and easy access to and within historic buildings, regardless of their level of mobility. With

sensitive design, listed buildings can be made more accessible, while still preserving and enhancing the character of the building.

- 3.28 Further guidance is available in CPG4 Protecting and improving quality of life (Access for all chapter) and in the English Heritage publication “Easy Access to Historic Buildings” [www.english-heritage.org.uk](http://www.english-heritage.org.uk)



### **How can historic buildings address sustainability?**

- 3.29 We recognise the role that the historic environment can play in reducing the impact of climate change. For example, reusing existing buildings could avoid the material and energy cost of new development. There are many ways to improve the efficiency and environmental impact of historic buildings, for example improving insulation, draught-proofing and integrating new energy-saving and renewable-energy technologies. We will seek to balance achieving higher environmental standards with protecting Camden's unique built environment (in accordance with LDF Core Strategy policies CS13 Tackling climate change through promoting higher environmental standards and CS14 Promoting high quality places and conserving our heritage) and PPS5 policy HE.1.
- 3.30 More detailed guidance on how to modify buildings without compromising their significance is contained within CPG3 Sustainability (Energy efficiency: new buildings, Energy efficiency: existing buildings, Renewable energy, Climate change adaptation, Water efficiency, Flooding and Sustainable use of materials). For further information see the links at the end of this chapter.

### **Planning obligations relating to heritage assets**

- 3.31 Many of the potential impacts of development on historic buildings and in archaeological priority and conservation areas can be covered through design and by conditions on the planning permission, for example the

need to carry out surveys or the storage and restoration of artefacts. Some objectives for building and area conservation or archaeology are unlikely to be satisfactorily controlled by a condition or in such cases and where impacts are off-site, or involve a particularly sensitive or complex programme of works, involving phasing, the Council may require implementation of these measures through a Section 106 Agreement.

### Further information

<p>Planning Policy Statement 5 (PPS5)</p>	<p>The Government's national policies on the historic environment are set out in:</p> <ul style="list-style-type: none"> <li>• Planning Policy Statement (PPS) 5 Planning for the historic environment – CLG, 2010</li> </ul> <p>If you want guidance implement this national policy, it is provided in:</p> <ul style="list-style-type: none"> <li>• PPS5, Planning for the Historic Environment, The Government's Statement on the Historic Environment for England, and The Historic Environment Planning Practice Guide</li> </ul>
<p>English Heritage</p>	<p><a href="http://www.englishheritage.org.uk">www.englishheritage.org.uk</a></p> <p>Guidance on heritage assets:</p> <ul style="list-style-type: none"> <li>• Guidance on Conservation Area Appraisals, 2006 – English Heritage;</li> <li>• Guidance on Management of Conservation Areas, 2006 – English Heritage;</li> <li>• Climate Change and the Historic Environment (2008); and</li> <li>• Heritage at Risk Register - English Heritage <a href="http://risk.english-heritage.org.uk/2010.aspx">http://risk.english-heritage.org.uk/2010.aspx</a></li> </ul> <p>Guidance on sustainability measures in heritage buildings:</p> <ul style="list-style-type: none"> <li>• Energy Conservation in Traditional Buildings</li> <li>• Climate Change and the Historic Environment</li> </ul> <p>There is also an online resource dedicated to climate change and the historic environment, available at:</p> <ul style="list-style-type: none"> <li>• <a href="http://www.englishheritage.org.uk/climatechangeandyourhome">www.englishheritage.org.uk/climatechangeandyourhome</a></li> </ul> <p>Guidance on accessibility:</p> <ul style="list-style-type: none"> <li>• Easy access to Historic Buildings, 2012</li> <li>• Easy access to Historic Landscapes, 2013</li> </ul>
<p>Energy Saving Trust</p>	<p><a href="http://www.est.org.uk">www.est.org.uk</a></p>





## 4 Extensions, alterations and conservatories

### KEY MESSAGES

- Alterations should always take into account the character and design of the property and its surroundings.
- Windows, doors and materials should complement the existing building.
- Rear extensions should be secondary to the building being extended.
- You can make certain types of minor alterations without planning permission (see below) external alterations.

4.1 This guidance provides advice to those seeking to alter or extend a residential property, including the erection of conservatories. The principles of this guidance also apply to extensions and alterations to other types of property. It expects high quality design that respects and enhances the character and appearance of a property and its surroundings, and also covers matters such as outlook, privacy and overlooking.

4.2 This guidance relates to Core Strategy Policy CS14 Promoting high quality places and conserving our heritage and Development Policies DP24 Securing high quality design.

### When does this apply?

4.3 This guidance applies to all proposals for alterations and extensions to residential properties, although some aspects will be relevant to alterations and extensions to other types of buildings.

4.4 You can make certain types of minor changes to your property without needing to apply for planning permission. These are called "permitted development rights", and further details can be found on the planning portal website [www.planningportal.gov.uk](http://www.planningportal.gov.uk) or by contacting the Council. In some conservation areas, Article 4 directions have been introduced which have removed certain permitted development rights. Details of Article 4 Directions, including where they apply in Camden can be found in the Conservation and Urban Design section of our website [www.camden.gov.uk](http://www.camden.gov.uk).

4.5 In addition to this guidance, you should also make reference to chapters on Heritage, Design excellence and Roofs, Terraces and balconies, in this CPG. If your property is situated within a conservation area then you should also refer to the relevant Conservation Area Statement, Appraisal or Management Plan, which sets out detailed guidelines for development in a particular area. Many of these are available on our website.

## Guidance for all extensions and alterations

### External alterations

- 4.6 The good practice principles set out below and the general design considerations for residential façades shown in Figure 1 – ‘Alterations to Residential Façades’ should be followed when undertaking external alterations. A façade is the front or face of a building.

### Good practice principles for external alterations

- 4.7 Alterations should always take into account the character and design of the property and its surroundings. A harmonious contrast with the existing property and surroundings may be appropriate for some new work to distinguish it from the existing building; in other cases closely matching materials and design details are more appropriate so as to ensure the new work blends with the old.

### Windows

- Where it is necessary to alter or replace windows that are original or in the style of the originals, they should be replaced like with like wherever possible in order to preserve the character of the property and the surrounding area. New windows should match the originals as closely as possible in terms of type, glazing patterns and proportions (including the shape, size and placement of glazing bars), opening method, materials and finishes, detailing and the overall size of the window opening.
- Where timber is the traditional window material, replacements should also be in timber frames. uPVC windows are not acceptable both aesthetically and for environmental reasons, including their relatively short lifespan and inability to biodegrade. Similarly, where steel is the traditional window material, steel replacements will be sought wherever possible, see also CPG3 Sustainability (Sustainable use of materials chapter), which gives guidance on the use of sustainable materials).
- Reference should be made to the Building Research Establishment’s (BRE) Green Guide to Specification when sourcing replacement window frames.
- Where the original glazing bars are highly detailed and intricate, or contain stained glass or leaded panes these should be retained and repaired. See also the Camden leaflet *A Guide to Windows (2006)*, which is available on our website, for advice on secondary glazing and other ways to improve energy efficiency while retaining attractive original features.
- Where windows are replaced they should have the lowest ‘U-value’ feasible.
- Listed building consent will be required for replacement windows, secondary glazing and double-glazing in listed buildings.
- In conservation areas original single-glazed windows often contribute to the character and appearance of the area, and should be retained

and upgraded. There may however be some instances where double-glazing can be installed in a design that matches the original, for instance sash windows or casements with large individual pane sizes, or in secondary glazing. In such cases, the window frame and glazing bars of the replacement windows should match the existing.

- Further guidance on window alterations and the effect that this can have on energy efficiency and protecting heritage assets can be found on English Heritage's 'Climate Change and your Home' website: [www.climatechangeandyourhome.org.uk](http://www.climatechangeandyourhome.org.uk)

### Doors

- Where you are looking to replace doors their design should match the dimensions, proportions, joinery details, panelling and glazing of the original. Where timber replacement doors are proposed the timber should be sustainably sourced.
- Characteristic doorway features, such as porches, such be retained where they make a positive contribution to the character of groups of buildings.

### Materials

- Wherever possible you should use materials that complement the colour and texture of the materials in the existing building, see also CPG3 Sustainability (Sustainable use of materials chapter). In historic areas traditional materials such as brick, stone, timber and render will usually be the most appropriate complement to the existing historic fabric; modern materials such as steel and glass may be appropriate but should be used sensitively and not dominate the existing property.
- Materials for alterations should weather well, so their ageing process contributes positively to the character of the building, and the site's wider context.
- Original surface finishes should be retained or replicated wherever possible, as they are usually central to the architectural design / character treatment of a building. These may cover the entire building or façade (such as stucco facing), the roof elements (such as roof tiles and roof ridges), highlight specific features (such as windows or doors) or act as decorative elements (such as ironwork or terracotta panels).
- When repairing existing wall finishes, the composition of the original material (such as plaster, stucco or render) should be determined, the defective area cut out and a replacement material of identical chemical composition applied and properly bonded. Concrete repairs are generally non-original and unsympathetic to historic buildings, and can damage bricks, and should be replaced with a more traditional lime-based finish.
- The insulating quality of materials should be considered, along with their embodied energy (the energy used in manufacture) and the potential for re-use and recycling.

- Alterations or repairs to brickwork or stonework should match the original in all respects while satisfying the needs of durability and maintenance. This should include matching the original bond, mortar colour and texture. Retention of any existing pointing is encouraged wherever possible.
- Samples of brick type and mortar colour will normally be required to be submitted to the Council as part of any application.
- Painting, rendering or cladding of brickwork will normally be resisted, as it is often unsightly and can damage the appearance of a building by obscuring the texture and original colour of the façade. Painting, rendering or cladding may also trap moisture, which can cause major damp problems in the masonry.

### External pipework

- Original external pipework and guttering should be repaired or reinstated in a like-for-like manner, where possible. In the case of historic buildings, cast iron replicas of original pipework are preferable to uPVC pipes. New pipework should be restricted to the side and rear elevations of buildings to avoid spoiling the appearance of the principal façade and should be grouped together and located in a discrete position.

### Scale

- 4.8 Extensions should be subordinate to the original building in terms of scale and situation unless the specific circumstances of the site, such as the context of the property or its particular design, would enable an exception to this approach. More detailed guidance on design considerations is contained within CPG1 Design (Design excellence chapter).

**Figure 2. Alterations to residential facades**

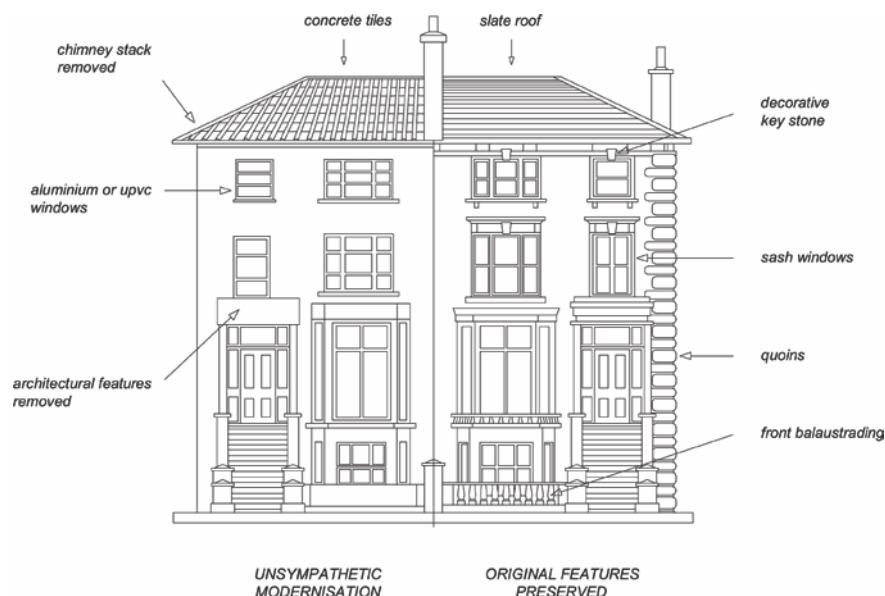

## Rear extensions

- 4.9 A rear extension is often the most appropriate way to extend a house or property. However, rear extensions that are insensitively or inappropriately designed can spoil the appearance of a property or group of properties and harm the amenity of neighbouring properties, for example in terms of outlook and access to daylight and sunlight.

### General principles

- 4.10 Rear extensions should be designed to:
- be secondary to the building being extended, in terms of location, form, scale, proportions, dimensions and detailing;
  - respect and preserve the original design and proportions of the building, including its architectural period and style;
  - respect and preserve existing architectural features, such as projecting bays, decorative balconies or chimney stacks;
  - respect and preserve the historic pattern and established townscape of the surrounding area, including the ratio of built to unbuilt space;
  - not cause a loss of amenity to adjacent properties with regard to sunlight, daylight, outlook, overshadowing, light pollution/spillage, privacy/overlooking, and sense of enclosure;
  - allow for the retention of a reasonable sized garden; and
  - retain the open character of existing natural landscaping and garden amenity, including that of neighbouring properties, proportionate to that of the surrounding area.
- 4.11 Materials should be chosen that are sympathetic to the existing building wherever possible (see also CPG3 Sustainability on Sustainable use of materials).

### Height of rear extensions

- 4.12 In order for new extensions to be subordinate to the original building, their heights should respect the existing pattern of rear extensions, where they exist. Ground floor extensions are generally considered preferable to those at higher levels. The maximum acceptable height of an extension should be determined in relation to the points outlined in paragraph 4.10 above. In cases where a higher extension is appropriate, a smaller footprint will generally be preferable to compensate for any increase in visual mass and bulk, overshadowing and overlooking that would be caused by the additional height.
- 4.13 In most cases, extensions that are higher than one full storey below roof eaves/parapet level, or that rise above the general height of neighbouring projections and nearby extensions, will be strongly discouraged.

### **Width of rear extensions**

- 4.14 The width of rear extensions should be designed so that they are not visible from the street and should respect the rhythm of existing rear extensions.
- 4.15 In addition, the rear of some buildings may be architecturally distinguished, either forming a harmonious composition, or visually contributing to the townscape. The Council will seek to preserve these where appropriate. Some of the Borough's important rear elevations are identified in conservation area statements, appraisals and management plans.

### **Side extensions**

- 4.16 Certain building forms may lend themselves to side extensions. Such extensions should be designed in accordance with the general considerations set out above in paragraph 4.10. Side extensions should also:
- be no taller than the porch; and
  - set back from the main building.
- 4.17 In many streets in the north of the Borough houses have mature rear gardens that can often be seen through gaps between buildings, softening the urban scene and providing visual interest. The infilling of gaps will not be considered acceptable where:
- significant views or gaps are compromised or blocked;
  - the established front building line is compromised;
  - the architectural symmetry or integrity of a composition is impaired;
  - the original architectural features on a side wall are obscured; or
  - access to the rear of a property is lost.
- 4.18 Where a property is located in a conservation area, reference should be made to the relevant conservation area statements, appraisals and management plans, which often identify important gaps and vistas where infilling would be inappropriate.

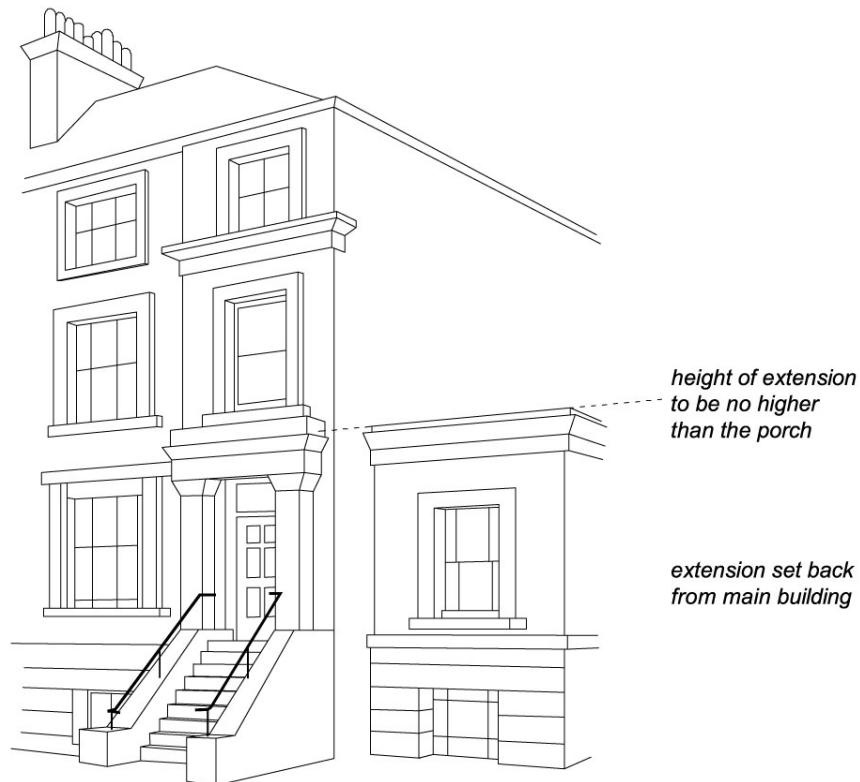
**Figure 3. Side extensions**

## Conservatories

4.19 Conservatories should normally:

- be located adjacent to the side and rear elevations of the building;
- be subordinate to the building being extended in terms of height, mass, bulk, plan form and detailing;
- respect and preserve existing architectural features, e.g. brick arches, windows etc;
- be located at ground or basement level. Only in exceptional circumstances will conservatories be allowed on upper levels;
- not extend the full width of a building. If a conservatory fills a gap beside a solid extension, it must be set back from the building line of the solid extension; and
- be of a high quality in both materials and design.

4.20 Conservatories should not overlook or cause light pollution to neighbouring properties, including to those in flats above. In order to minimise overlooking, opaque lightweight materials such as obscured glass may be necessary on façades abutting neighbouring properties. Also, in order to minimise light pollution, solid lightweight materials, one-way glass or obscured glass may be required.



- 4.21 Further guidance is contained within CPG4 Protecting and improving quality of life (Light Pollution chapter).

#### **Development in rear gardens and other open land**

- 4.22 The construction of garden buildings, including sheds, stand-alone green houses and other structures in rear gardens and other undeveloped areas, can often have a significant impact upon the amenity, biodiversity and character of an area. They may detract from the generally soft and green nature of gardens and other open space, contributing to the loss of amenity for existing and future residents of the property.
- 4.23 Large garden buildings may also affect the amenity value of neighbours' gardens, and if used for purposes other than storage or gardening, may intensify the use of garden spaces.
- 4.24 Development in rear gardens should:
- ensure the siting, location, scale and design of the proposed development has a minimal visual impact on, and is visually subordinate to, the host garden
  - not detract from the open character and garden amenity of the neighbouring gardens and the wider surrounding area
  - use suitable soft landscaping to reduce the impact of the proposed development
  - ensure building heights will retain visibility over garden walls and fences
  - use materials which complement the host property and the overall character of the surrounding area. The construction method should minimise any impact on trees (also see Landscape design and trees chapter in this CPG), or adjacent structures
  - address any impacts of extensions and alterations upon water run-off and groundwater flows, both independently or cumulatively with other extensions, and demonstrate that the impact of the new development on water run-off and groundwater flows will be negated by the measures proposed. Reference should be made to CPG3 Sustainability (Flooding chapter).
- 4.25 Pockets of privately owned land make important contributions to the character of certain parts of the borough, both in established neighbourhoods and areas of new development, creating village greens, informal verges, set backs for established structures or settings for listed buildings. Building on such areas will generally be discouraged.
- 4.26 Where any type of development, either in a rear garden or on private land that forms part of a public space, may be appropriate in principle, a full assessment should be made prior to the commencement of the development to avoid any potential impact upon trees or other vegetation in the surrounding area. This assessment may be required as part of an application for planning permission.



### **Further information**

- 4.27 The following professional bodies provide further guidance and advice on buildings and design matters:
- Royal Institute of Chartered Surveyors (RICS); and
  - Royal Institute of British Architects (RIBA).



## 5 Roofs, terraces and balconies

### KEY MESSAGES

Roof extensions fall into two categories:

- Alterations to the overall roof form; or
- Smaller alterations within the existing roof form, such as balconies and terraces.

When proposing roof alterations and extensions, the main considerations should be:

- The scale and visual prominence;
- The effect on the established townscape and architectural style;
- The effect on neighbouring properties

- 5.1 This guidance provides advice on roof alterations and extensions and on proposals for balconies and terraces. The Council will seek to ensure that roof alterations are sympathetic and do not harm the character and appearance of buildings or the wider townscape in the borough.
- 5.2 This guidance replates primarily to Development Policies DP24 Securing high quality design and DP25 Conserving Camden's Heritage.

### When does this apply?

- 5.3 This guidance applies to all planning applications involving roof alterations, roof extensions, balconies and terraces, and is particularly relevant to residential properties.
- 5.4 For properties in conservation areas, reference should also be made to the relevant conservation area statements, appraisals and management plans. These describe the area and its special character and contain specific area-based advice.
- 5.5 Where buildings are listed, reference should also be made to planning guidance on Heritage.

### Roof alterations and extensions – general principles

- 5.6 Proposals to alter and extend roofs fall into two categories: those that are accommodated within the existing roof form, such as dormer windows and roof lights, and those which alter the overall roof form, such as the construction of mansard roofs.
- 5.7 Additional storeys and roof alterations are likely to be **acceptable** where:
- There is an established form of roof addition or alteration to a terrace or group of similar buildings and where continuing the pattern of development would help to re-unite a group of buildings and townscape;

- Alterations are architecturally sympathetic to the age and character of the building and retain the overall integrity of the roof form;
- There are a variety of additions or alterations to roofs which create an established pattern and where further development of a similar form would not cause additional harm.

5.8 A roof alteration or addition is likely to be **unacceptable** in the following circumstances where there is likely to be an adverse affect on the skyline, the appearance of the building or the surrounding street scene:

- There is an unbroken run of valley roofs;
- Complete terraces or groups of buildings have a roof line that is largely unimpaired by alterations or extensions, even when a proposal involves adding to the whole terrace or group as a co-ordinated design;
- Buildings or terraces which already have an additional storey or mansard;
- Buildings already higher than neighbouring properties where an additional storey would add significantly to the bulk or unbalance the architectural composition;
- Buildings or terraces which have a roof line that is exposed to important London-wide and local views from public spaces;
- Buildings whose roof construction or form are unsuitable for roof additions such as shallow pitched roofs with eaves;
- The building is designed as a complete composition where its architectural style would be undermined by any addition at roof level;
- Buildings are part of a group where differing heights add visual interest and where a roof extension would detract from this variety of form;
- Where the scale and proportions of the building would be overwhelmed by additional extension.

5.9 Materials, such as clay tiles, slate, lead or copper, that visually blend with existing materials, are preferred for roof alterations and repairs. Where roofs are being refurbished, original materials such as keyhole ridge tiles or decorative chimney stacks and chimney pots should be reused. Replacement by inappropriate substitutes erodes the character and appearance of buildings and areas.

5.10 Where the principle of an additional storey is acceptable, the more specific guidance set out below will apply. This advice is supplemented by more specific area-based advice as set out in the Council's conservation area statements, appraisals and management plans which set out our approach to preserving and enhancing such areas. Many of these appraisals and management plans are available for download on our website, or are available as hard copies from our Planning reception.

## Roof dormers

- 5.11 Alterations to, or the addition of, roof dormers should be sensitive changes which maintain the overall structure of the existing roof form. Proposals that achieve this will be generally considered acceptable, providing that the following circumstances are met:
- a) The pitch of the existing roof is sufficient to allow adequate habitable space without the creation of disproportionately large dormers or raising the roof ridge. Dormers should not be introduced to shallow-pitched roofs.
  - b) Dormers should not be introduced where they cut through the roof ridge or the sloped edge of a hipped roof. They should also be sufficiently below the ridge of the roof in order to avoid projecting into the roofline when viewed from a distance. Usually a 500mm gap is required between the dormer and the ridge or hip to maintain this separation (see Figure 4). Full-length dormers, on both the front and rear of the property, will be discouraged to minimise the prominence of these structures.
  - c) Dormers should not be introduced where they interrupt an unbroken roofscape.
  - d) In number, form, scale and pane size, the dormer and window should relate to the façade below and the surface area of the roof. They should appear as separate small projections on the roof surface. They should generally be aligned with windows on the lower floors and be of a size that is clearly subordinate to the windows below. In some very narrow frontage houses, a single dormer placed centrally may be preferable (see Figure 4). It is important to ensure the dormer sides (“cheeks”) are no wider than the structure requires as this can give an overly dominant appearance. Deep fascias and eaves gutters should be avoided.
  - e) Where buildings have a parapet the lower edge of the dormer should be located below the parapet line (see Figure 4).
  - f) Materials should complement the main building and the wider townscape and the use of traditional materials such as timber, lead and hanging tiles are preferred.

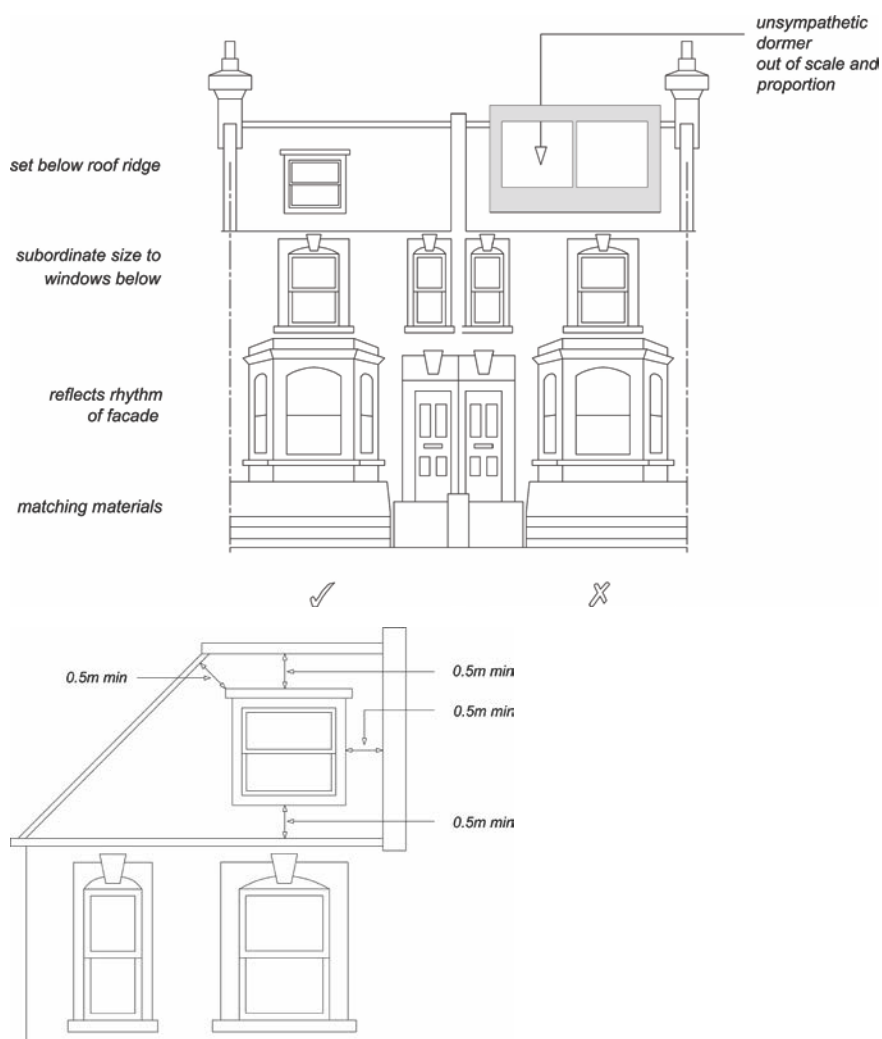
**Figure 4. Dormer windows**

5.12 See CPG2 Housing (Residential development standards chapter) for further information, particularly the section on ceiling heights.

5.13 The presence of unsuitably designed new or altered dormers on neighbouring properties will not serve as a precedent for further development of the same kind.

### **Mansard Roofs**

5.14 Mansard roofs are a traditional means of terminating a building without adding a highly visible roof. This form is acceptable where it is the established roof form in a group of buildings or townscape.

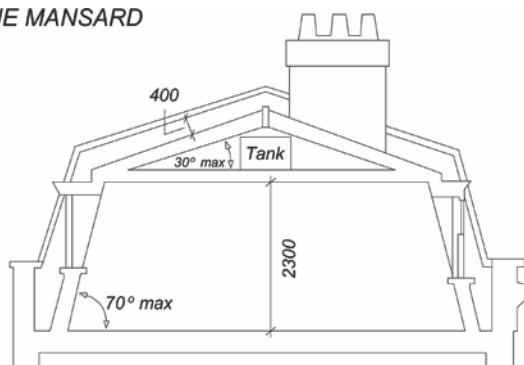
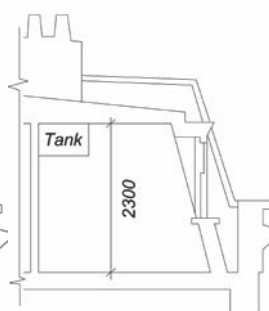
**Figure 5. Mansard Roofs****TRUE MANSARD****FLAT TOP MANSARD****True Mansard**

Lower slope is at a steeper angle than the upper, and the upper slope is visible

**Flat topped Mansard**

Upper slope of a pitch below 5° or totally flat

- 5.15 Mansard roofs are often the most appropriate form of extension for a Georgian or Victorian dwelling with a raised parapet wall and low roof structure behind. Mansard roofs should not exceed the height stated in Figure 5 so as to avoid excessive additional height to the host building. They are often a historically appropriate solution for traditional townscapes. It should be noted that other forms of roof extensions may also be appropriate in situations where there is a strong continuous parapet and the extension is sufficiently set back or where they would match other existing sympathetic roof extension already in the terrace.

**Parapet wall**

A low wall or railing that is built along the edge of a roof, balcony or terrace for protection purposes.

**Cornice**

The topmost architectural element of a building, projecting forward from the main walls, originally used as a means of directing rainwater away from the building's walls.

- 5.16 The three main aspects to consider when designing a mansard roof extension are its:
- pitches and profile;
  - external covering; and
  - windows.
- 5.17 The lower slope (usually 60-70°) should rise from behind and not on top of the parapet wall, separated from the wall by a substantial gutter. Original cornice, parapet and railing details should be retained and where deteriorated or lost, should be incorporated into the design of new roof extensions. Visible chimney stacks should be retained and increased in height, where necessary. Only party walls with their chimney stacks and windows should break the plane of the roof slope, and should be accommodated in a sensitive way and be hidden as far

as is possible. (See also guidance on dormer windows and roof lights). Dormer windows or roof lights should be confined to the lower slope.

- 5.18 Roofing materials should be of the highest quality because of their significant visual impact on the appearance of a building and townscape and the need to be weather-tight. Natural slate is the most common covering and this should be laid with a traditional overlap pattern. Artificial slate or felt are not acceptable roof coverings in conservation areas. Where a roof in a conservation area is being re-covered, the choice of covering should replicate the original, usually natural slate or clay tile.

### Valley or Butterfly roofs

- 5.19 On buildings with a 'valley' or 'butterfly' roof if a mansard extension is considered acceptable in terms of the guidance in paragraphs 5.7 and 5.8 of this chapter, then the parapet should be retained. The new roof should start from behind the parapet at existing hopper-head level, forming a continuous slope of up to a maximum of 70° (see Figure 6). In this context, it is usually more appropriate to introduce conservation-style roof lights, which are flush with the roof slope, rather than dormers. Terraces and additional railings will not usually be acceptable.

**Figure 6. Butterfly roofs**

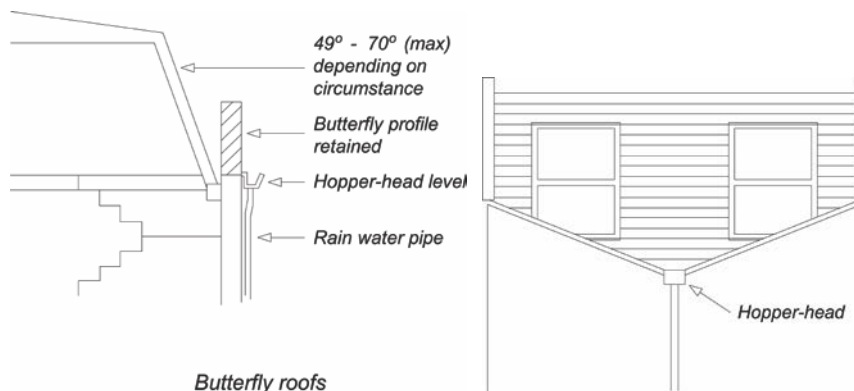

#### **Hopper head level**

The level at which the 'hopper head' (a square or funnel shaped receptacle to connect rainwater or waste pipes to a down-pipe) is positioned.

### Other roof additions

- 5.20 On some contemporary buildings a less traditional form of roof addition may be more appropriate. In such cases, proposals should still have regard for the following general principles:
- The visual prominence, scale and bulk of the extension;
  - Use of high quality materials and details;



- Impact on adjoining properties both in terms of bulk and design and amenity of neighbours, e.g. loss of light due to additional height;
- Sympathetic design and relationship to the main building.

### **Roof lights**

- 5.21 Roof lights can have an adverse impact upon the character and appearance of buildings and streetscapes. This occurs where they are raised above the roof slope rather than being flush with the roof profile, or where they are an incompatible introduction into an otherwise uncluttered roofscape, or where they conflict with other architectural roof elements, e.g. gables and turrets.
- 5.22 Roof lights should be proportioned to be significantly subordinate both in size and number and should be fitted flush with the roof surface. Some properties, particularly listed buildings and those within conservation areas with prominent roof slopes may be so sensitive to changes that even the installation of roof lights may not be acceptable.

### **Balconies and terraces**

- 5.23 Balconies and terraces can provide valuable amenity space for flats that would otherwise have little or no private exterior space. However, they can also cause nuisance to neighbours. Potential problems include overlooking and privacy, daylight, noise, light spillage and security.
- 5.24 Balconies and terraces should form an integral element in the design of elevations. The key to whether a design is acceptable is the degree to which the balcony or terrace complements the elevation upon which it is to be located. Consideration should therefore be given to the following:
- detailed design to reduce the impact on the existing elevation;
  - careful choice of materials and colour to match the existing elevation;
  - possible use of setbacks to minimise overlooking – a balcony need not necessarily cover the entire available roof space;
  - possible use of screens or planting to prevent overlooking of habitable rooms or nearby gardens, without reducing daylight and sunlight or outlook; and
  - need to avoid creating climbing opportunities for burglars.

### **Roof Level**

- 5.25 A terrace provided at roof level should be set back behind the slope of a pitched roof in accordance with Figure 7, or behind a parapet on a flat roof. A terrace should normally comply with the following criteria:
- The dimensions of the roof should be sufficient to accommodate a terrace without adversely affecting the appearance of the roof or the elevation of the property.
  - A terrace will only normally be acceptable on the rear of properties. It is normally inappropriate to set back a mansard to provide a terrace.

- It should not result in the parapet height being altered, or, in the case of valley/butterfly roofs, the infilling of the rear valley parapet by brickwork or railings.
- Any handrails required should be well set back behind the line of the roof slope, and be invisible from the ground.
- It should not result in overlooking of habitable rooms of adjacent properties.

- 5.26 When a terrace is provided within the slope of a pitch as in Figure 7, the adjacent tiles or slates should be kept unbroken above the eaves. The width of the terrace should be no wider than a dormer opening. A terrace may be acceptable behind an existing parapet. Where the height of the parapet is less than 1.1m, a railing will be required to fulfil Building Regulations.

**Figure 7. Roof terraces**

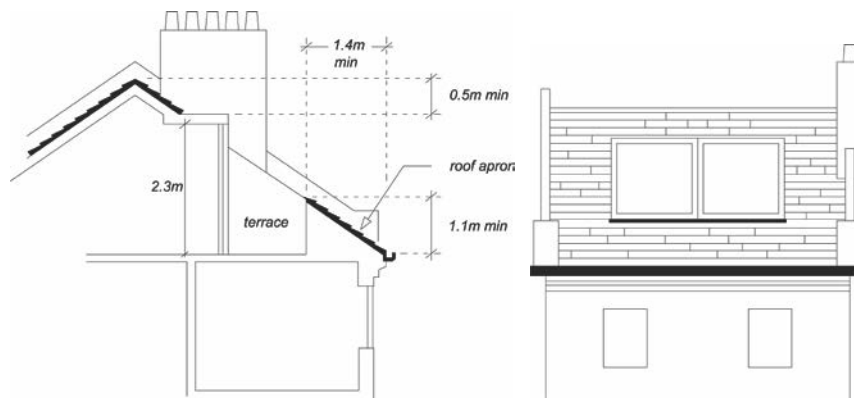

### **Building services equipment**

- 5.27 New building services equipment and water tanks should be accommodated within the envelope of the building and its siting should be considered as part of the overall design (see chapter on Building services equipment in this CPG). Building services equipment includes, but is not limited to, heating and cooling systems, ventilation and extraction systems and associated ducting for electricity, communications and plumbing.

### **Green roofs**

- 5.28 We encourage the incorporation of green roofs into schemes where appropriate in design terms (see chapter on Green roofs and walls in CPG3 Sustainability). You should contact the Council to confirm whether planning permission is required for green roofs. Planning permission is not required on flat roofs which are concealed by a parapet.

### **Solar panels**

- 5.29 We encourage the installation of solar panels into schemes and for some properties these will not need planning permission. You should

contact the Council and visit the Planning Portal website [www.planningportal.gov.uk](http://www.planningportal.gov.uk) to confirm whether planning permission is required for solar panels. Solar panels should be sited so as to maximise efficiency but minimise their visual impact and glare, for example utilising valley roofs and concealed roof slopes. Reference should be made to CPG3 Sustainability (Energy Efficiency: existing buildings and Energy Efficiency: new buildings chapters).



## 6 Landscape design and trees

### KEY MESSAGES

- Camden's trees and green spaces are integral to its character.
- Landscape design and green infrastructure should be fully integrated into the design of schemes from the outset.
- We require a survey of existing trees and vegetation to be carried out prior to the design of a scheme.

- 6.1 This guidance sets out how to protect trees and vegetation and design high quality landscapes in conjunction with development proposals to ensure an attractive, safe, accessible, sustainable and ecologically diverse environment.
- 6.2 This chapter sets out:
- how existing trees and landscape should be protected;
  - what specific protection is given to some trees;
  - how new landscaping should be incorporated into developments; and
  - considerations for specific landscaped areas and types of landscaping.
- 6.3 The green landscape of the Borough is formed by parks and open spaces, railway and canal corridors, trees, gardens, green walls and roofs. These landscape components provide Camden's green infrastructure and play a key role in maintaining the local climate, reducing storm water run off, increasing biodiversity, providing space for urban food production and providing public enjoyment.
- 6.4 We expect landscape design and the provision of green infrastructure to be fully integrated into the design of development proposals from the beginning of the design process.
- 6.5 This section sets out further guidance on how we will apply Core Strategy Policy CS14 Promoting high quality places and conserving our heritage and Development Policy DP24 Securing high quality design.

### **Where does this guidance apply?**

- 6.6 This guidance applies to all proposals affecting or including landscape design on and around buildings and proposals relating to on and off site trees.

### **How should existing Trees and Landscape be protected?**

#### **Benefits of retaining vegetation and trees**

- 6.7 Vegetation of all types is at a premium in Camden given the Borough's dense urban environment. Camden's tree canopy and other existing vegetation are integral to its character. If you maintain existing trees and

vegetation on a development site it will help provide a sense of maturity to a development and integrate a development into its setting. Existing trees and vegetation are a key component in adapting to climate change and conserving biodiversity. See CPG3 Sustainability chapters on Climate change adaptation and Biodiversity. Existing species can serve as an indicator of what might be successfully grown on the site when selecting additional plants. The retention of existing mature trees and vegetation also make an important contribution to the sustainability of a project. For example by reducing the impacts and energy demand associated with the provision of new plants such as in their transportation and the irrigation required.

### **How should existing trees and vegetation be protected?**

- 6.8 We will require a survey of existing trees and vegetation to be carried out prior to the design of a scheme in order to identify what trees and vegetation should be retained and protected on site. We will expect developers to follow the principles and practices set out in BS 5837: 2005 Trees in relation to construction to integrate existing trees into new developments.



- 6.9 BS5837: 2005 Trees in relation to construction outlines the survey method for identifying which trees should be retained and protected. Once the survey has identified the important trees and vegetation a Tree Constraints Plan (TCP) needs to be prepared for the site. The TCP is essential to site planning as it provides the limitations for development including:
- site layout and building lines;
  - changes in levels;
  - foundation design; and

- service provision where the root zones and crown spread of trees are to be protected.

#### **NEW UTILITIES**

Useful guidance for the installation of new utilities in the vicinity of trees is also provided in National Joint Utilities Group (NJUG) Vol 4 - Guidelines for the Planning, Installation and Maintenance of Utility Apparatus in Proximity to Trees

- 6.10 The TCP should also identify the provision of sufficient space, above and below ground for new planting to develop and mature and existing trees to continue to grow (see paragraph 6.42 below regarding soft landscape design).
- 6.11 Where trees are identified to be retained it is imperative that contracting and site supervision procedures are in place to ensure that there is no damage during and after construction. We will normally seek a Method Statement which sets out how trees that are to be retained, both on and adjacent to the site will be protected. The Method Statement should identify how the provision of site accommodation, storage areas, site access and the positioning, heights and arcs of cranes will not affect the trees and vegetation that are to be protected.

#### **Root zone**

The area and volume of soil around the tree in which roots are found. May extend to three or more times the branch spread of the tree, or several times the height of the tree.

#### **Crown spread**

The extent of the branches, twigs and leaves that form the top of the tree

#### **Specific protection for trees**

- 6.12 Where a planning application involves works that affect trees either within the application site or on adjacent land (including street trees) we will require the following information to determine the application:
1. A Tree Survey  
(see section 4.2 of BS5837:2005)
  2. A Tree Constraints Plan  
(see sections 5.2 and 5.3 of BS5837:2005)
  3. An Arboricultural Implications Assessment  
(see section 6 of BS5837:2005)
  4. An Arboricultural Method Statement for the protection of trees to be retained including a Tree Protection Plan  
(see section 7 of BS5837:2005)
- 6.13 Failure to supply the documents outlined above may lead to a planning application not being validated.



- 6.14 To obtain a copy of BS5837:2005 please visit [www.StandardsUK.com](http://www.StandardsUK.com) and for a list of arboricultural consultants visit [www.trees.org.uk](http://www.trees.org.uk), [www.charteredforesters.org](http://www.charteredforesters.org) and [www.consultingarboristssociety.co.uk](http://www.consultingarboristssociety.co.uk).

### **Tree preservation orders**

- 6.15 Many trees in Camden are covered by a Tree Preservation Order (TPO). Please contact the Council to find out if a tree is protected by a TPO.

#### **TREE PRESERVATION ORDER**

A tree preservation order is made by the Council to legally protect specific trees or groups of trees that provide public amenity.

Unauthorised works to a tree with a TPO is a criminal offence and may result in prosecution and, upon conviction, a fine.

- 6.16 Works (above or below ground) to trees with a TPO require our permission. Application forms for these works are available at [www.camden.gov.uk](http://www.camden.gov.uk).
- 6.17 Works to a tree with a TPO required to enable the implementation of a planning permission are dealt with as part of a planning application. A further TPO application is not required.

### **Trees in Conservation Areas**

#### **SECTION 211**

Under Section 211 of the Town & Country Planning Act 1990, anyone proposing to cut down or carry out work on a tree in a Conservation Area must provide the Council 6 weeks notice of their intention to do so.

- 6.18 All trees in Conservation Areas with a trunk diameter of 75mm or greater measured at 1.5m above ground level are protected under section 211 of the Town and Country Planning Act 1990 (as amended). If you are proposing works to a tree in a Conservation Area, above or below ground, you are required to give Camden Planning Services six weeks notice of your proposals (See above link for forms). Works to a tree in a Conservation Area required to facilitate the implementation of a planning permission are dealt with as part of a planning application. A further section 211 Notification is not required. If you carry out unauthorised works to a tree in a Conservation Area is a criminal offence and may result in prosecution and, upon conviction, a fine.

### **How should new landscaping be included into a development?**

#### **General principles**

- 6.19 Urban landscape design encompasses the following types of spaces:
- streets and associated public spaces,
  - parks, public and private squares, gardens,
  - amenity and servicing space around buildings; and

- buildings themselves.

6.20 The principle components of landscape design are soft landscape details (planting) and hard landscape details (the constructed aspects of design) for example surfaces, lighting, seating, water features and boundary treatments.

6.21 Urban spaces have particular character which results from a combination of factors including geology, ecology, topography and the history of their development and use. We will expect new landscape design to respond to, preserve and enhance local character, including through the:

- preservation of existing trees and hedges;
- planting of new trees and hedges; and
- detailed design of boundary treatments and spaces within the site particularly where they are visible to the public domain.



6.22 Planning applications will be assessed against

- the successful resolution of the above elements into the design of the site
- whether the site design has optimised opportunities to increase a site's sustainability and function in adapting to climate change (see CPG3 Sustainability for further details on Biodiversity and Climate change adaptation)
- the need to reduce opportunities for criminal behaviour (see the chapter in this guidance on Designing safer environments)
- the need to provide inclusive environments (see CPG6)

### **Specific areas that are landscaped and contain trees**

6.23 Areas within a development site that are generally landscaped include:

- gardens;
- access and servicing routes;
- parking spaces and cycle stores;
- boundary walls, fences and railings; and

- building roofs and walls.

### **Gardens**

- 6.24 Front, side and rear gardens make an important contribution to the townscape of the Borough and contribute to the distinctive character and appearance of individual buildings and their surroundings. Gardens are particularly prone to development pressure in the Borough with their loss resulting in the erosion of local character and amenity, biodiversity and their function in reducing local storm water run off.

### **Front Gardens**

- 6.25 The design of front gardens and forecourt parking areas make a large impact on the character and attractiveness of an area and in particular the streetscene. The design of front gardens and other similar forecourt spaces should:
- consider a balance between hard and soft landscaping. Where changes take place no more than 50% of the frontage area should become hard landscape. Where parking areas form part of the forecourt enough of the front boundary enclosure should be retained to retain the spatial definition of the forecourt to the street and provide screening;
  - retain trees and vegetation which contribute to the character of the site and surrounding area;
  - retain or re-introduce original surface materials and boundary features, especially in Conservation Areas such as walls, railings and hedges where they have been removed. If new materials are to be introduced they should be complementary to the setting; and
  - prevent the excavation of lightwells as a means of providing access to basements where this does not form part of the historical means of access to these areas.



## Paving of front gardens

### CHANGES TO PERMITTED DEVELOPMENT

The General Permitted Development Order no longer allows the creation of more than 5 square meters of impermeable surfaces at the front of dwelling houses that would allow uncontrolled runoff of rainwater from front gardens onto roads without first obtaining planning permission.

Changes to frontages incorporating hard standings may also be affected by Article 4 Directions. Article 4 Directions are issued by the Council in circumstances where specific control over development is required, primarily where the character of an area of acknowledged importance would be threatened, such as conservation areas

- 6.26 Planning Permission will not be granted for hard standings greater than five square metres that do not incorporate sustainable urban drainage systems (SUDS) into the design. SUDS incorporate permeable surfaces to allow water to soak into the subsoil, rather than being diverted into the stormwater system. SUDS are particularly appropriate in the parts of the borough north of Euston Road as this area has predominantly clay soils. Methods for choosing the appropriate design of a SUDS are provided in “Responsible rainwater management around the home” available from [www.paving.org.uk](http://www.paving.org.uk). Planning applications which incorporate car parking areas into developments will be required to demonstrate that the chosen solution is appropriate to the underlying soil type.

### Creating a cross over

- 6.27 For single family dwellings planning permission is not required for the creation of a cross over unless the property is affected by an Article 4 Direction or the cross over is to a classified road. However permission is required for the formation of a cross over from the Highways Authority. The Highways Authority will generally refuse permission where it would result in the loss of on street car parking spaces.
- 6.28 Planning permission is required for forecourt parking at the fronted of buildings divided into flats. Listed Building Consent is required to alterations to structures affecting listed buildings including structures within their curtilage.

#### Listed building consent

Legally required in order to carry out any works to a Listed Building which will affect its special value. This is necessary for any major works, but may also be necessary for minor alterations and even repairs and maintenance. Listed Building Consent may also be necessary for a change of use of the property.

## Rear Gardens

- 6.29 Rear gardens are important as they:
- form part of the semi public domain where they are over looked by large numbers of properties and the occupants of surrounding buildings benefit from the outlook.

- form the character of an area in terms of the relationship between buildings and spaces and the resulting openness or sense of enclosure
- provide a sense of the greenery where they can be viewed through gaps between buildings
- provide a sense of visual separation and privacy
- soften the impact of buildings and integrate them into their setting
- play a significant role in maintaining the biodiversity of the borough (see CPG3 Sustainability for further details on Biodiversity). In particular groups of trees and vegetation along the rear boundaries of garden provide important wild life corridors within existing development patterns.

6.30 The potential detrimental affects of new structures in gardens can be reduced by:

- carefully siting structures away from vegetation and trees,
- designing foundation to minimises damage to the root protection zones of adjacent trees,
- including green roofs, green walls on new development and vegetation screens.

**Root protection zone**

The area around the base or roots of the tree that needs to be protected from development and compaction during construction to ensure the survival of the tree.

6.31 Planning permission is unlikely to be granted for development whether in the form of extensions, conservatories, garden studios, basements or new development which significantly erode the character of existing garden spaces and their function in providing wildlife habitat (See the chapters on Extensions, Alterations and Conservatories in this guidance document, and CPG4 on Basements).

**Access and servicing areas**

6.32 Where underground parking and/or servicing forms part of a larger development, access should be integral to the design of the development. Entrances and ramps should be discrete.

6.33 Entrances and adjoining areas of buildings are often spaces which require the integration of a number of competing needs such as the provision of bins, cycle storage, meters and inspection boxes and external lighting. These elements should be constructed with materials sympathetic to the site and surroundings. You can minimise the visual impact of storage areas by careful siting and incorporating planters to screen developments and incorporating green roofs as part of their structure.

6.34 Space and location requirements for the storage of waste and recycling can be found in this guidance in chapter on Waste and recycling



storage. Further guidance on how access to site and parking areas should be designed can be found in CPG6 Transport.

### **Boundary Walls, Fences and Railings**

- 6.35 Boundary walls, fences and railings form the built elements of boundary treatments. They should be considered together with the potential for elements of soft landscaping. For example, we encourage the combination of low brick boundary walls and hedges as a boundary treatment. Boundary treatments should:
- delineate public and private areas;
  - contribute to qualities of continuity and enclosure within the street scene; and
  - provide site security and privacy.
- 6.36 Due to the prominence of the boundary treatments in the streetscene we will expect the design, detailing and materials used to provide a strong positive contribution to the character and distinctiveness of the area and integrate the site into the streetscene.
- 6.37 With regards to boundary walls, fences and railings, we will expect that:
- you consider repairing boundary walls, fences and railings before they are replaced;
  - they make a positive contribution to the appearance and character of the development site and to the streetscene;
  - you consider designs to be effective for their function.
  - the design and construction does not damage any on site or off site trees that are identified for retention (See paragraphs 6.15 to 6.18 above).
- 6.38 For boundary treatments around listed buildings or in a conservation area we will expect:
- the elements are repaired or replaced to replicate the original design and detailing and comprise the same materials as the original features
  - the works preserve and enhance the existing qualities and context of the site and surrounding area
- 6.39 Planning Permission is not required for the erection of a boundary treatment no higher than 1m where it abuts the highway or 2m on any other boundary. These heights are measured from ground level and include any structure that may be attached for example a trellis attached to the top of boundary wall.
- 6.40 Listed Building consent may be required for any works to boundary treatments within the curtilage of a listed building.

### **Types of landscaping**

- 6.41 Landscaping are divided into the following broad types:

- soft landscaping (planting);
- hard landscaping; and
- landscaping on building.

#### **Soft Landscape Details (Planting)**

6.42 Soft Landscape is a term to describe the organic, vegetative or natural elements of Landscape Design. There are three main objectives in planting design (1) Functional (2) Ecological and (3) Aesthetic. Each of these objectives is likely to be inter related however one may be prioritised over another for the purpose of a particular project.

6.43 Functional objectives include:

- integrating a site with its surroundings;
- providing spatial definition and enclosure;
- directing pedestrian and vehicular movement;
- providing shelter,
- providing micro climatic amelioration and
- providing SUDS.

#### **Ecological Objectives include:**

- maintaining and enhancing natural processes; and
- increasing the biodiversity value of a site.

#### **Aesthetic Objectives include:**

- creating or contributing to the character of a place; and
- adding to people's sensory enjoyment in the use of a space.

<b>Crown canopy</b>
---------------------

The uppermost layer in a forest or group of trees.
--

6.44 Landscaping schemes need to maintain and plant large canopy trees as a means of countering the negative effects of increasing urban temperatures due to climate change. Existing large canopy trees are part of the character of several areas in the Borough. In these areas in particular and other areas where the opportunity arises space should be made for the growth and development of large canopy trees. Large canopy trees are usually considered to be trees which reach a mature height of 15-20m+. Site design should make provision for the expansion of the crown canopy of these trees and sufficient soil volume to support a trees growth to maturity. As a general rule the soil volume required to support a healthy large canopy tree is 6m x 6m x 1m depth. The detailed requirements for the growth and development of large canopy urban trees can be found in "Up by the Roots" by James Urban (International Society for Arboriculture, 2008).

6.45 The long term success of planting schemes will determine species selection suitable for local growing conditions (soil conditions, temperature ranges, rainfall, sun light and shade) and provision for on



going maintenance. Generally native species are considered to be most adapted to local conditions however there are a range of exotic plants which are at least equally adaptable to the unique ecology of urban areas and which provide an important contribution to a site's biodiversity.

- 6.46 Maintenance requirements should be considered at the design stage in terms of ensuring there is access for maintenance, whether maintenance materials need to be stored on site and that there are available sources of water. Water conservation should be intrinsic to the design of a planting scheme whether it is by selecting drought tolerant plants, maintaining soil conditions conducive to water retention with, for example, mulching or providing for on site water harvesting and grey water recycling.
- 6.47 Planning applications will be assessed against the degree to which planting schemes meet their objectives and that the chosen objectives are appropriate for the site. Planning applications should be accompanied by:
1. a statement of the design objectives of planting plans;
  2. planting plans indicating species, planting patterns, planting size and density; and
  3. where appropriate managements plans.

### **Hard Landscape Details**

- 6.48 Hard landscape is a term used to describe the hard materials used in landscape design such as paving, seating, water features, lighting, fences, walls and railings (see paragraphs 6.35 to 6.38 above for guidance on boundary walls, fences and railings and the chapter on Design excellence regarding the design of public space).
- 6.49 Hard landscape makes a significant contribution to the character of the Borough. The scale, type, pattern and mix of materials help define different uses and effects the perception of the surrounding buildings and soft landscape and overall quality of an area. To help integrate the development with its surroundings and contribute to the sustainability of the project we will expect:
- the selection of materials, patterning and methods of workmanship to consider those already at use in the area;
  - traditional and natural materials to be used, especially in Conservation Areas (Guidance can be found in Conservation Area Statements, Appraisals and Management Plans);
  - the use of salvaged and re used materials, where appropriate; and
  - all paving to be level and accessible where used by pedestrians, this needs careful consideration where the use of historic materials is proposed.
- 6.50 The Council will discourage the replacement of soft landscaping with hard landscaping in order to preserve the environmental benefits of vegetation identified above. However where hard landscape is

unavoidable we will seek sustainable drainage solution to any drainage (see CPG3 Sustainability chapter on Flooding).

### **Lighting**

- 6.51 Lighting can make an important contribution to the attractiveness of an area. It is also important for the security and safety of an area. The design and siting of columns and lights can provide a significant role in the creation of the character of a place. Other lighting techniques include wall mounting, bollards with integral lights and ground level up lighters. While adequate lighting is required, the intensity of lighting should be appropriate to its function. Care should be taken not to over light which can lead to unnecessary light pollution and energy consumption and in some cases become a nuisance to neighbouring residential properties. Lightning can also become a disturbance to local wildlife, particularly bats, and can affect the wildlife that uses and lives on the canal.

### **Landscaping on buildings**

- 6.52 Landscaping on buildings includes both soft and hard landscaping and occurs in the forms of green and brown roofs and green walls. Green roofs, brown roofs and green walls can provide important landscape detail, biodiversity improvements, prevent local flooding and keep a building insulated. See CPG3 Sustainability (Green roofs and walls chapter).

## 7 Shopfronts

### KEY MESSAGES

Shopfront alterations should respect the detailed design, materials, colour and architectural features of the shopfront and building itself.

This section provides information on how to deal with the five key shopfront features:

- Shopfront components,
- Signs and lighting,
- Blinds and canopies,
- Security shutters,
- Cash machines.

- 7.1 Well designed shopfronts increase the attractiveness of a building and the local area and can have an impact on commercial success by increasing the attraction of shops and shopping centres to customers. This is particularly important in town centres and the character and appearance of where conservation area and listed buildings. On the other hand, insensitive shopfront design can harm the appearance and character of buildings and shopping areas
- 7.2 This guidance relates to Core Strategy Policy – CS14 – Promoting High Quality places and Conserving Our Heritage and Development Plan Policies – DP30 – Shopfronts – and to planning applications for new shopfronts and alterations for existing.



### When does this guidance apply?

#### General

- 7.3 This guidance applies to all applications which may materially alter the external appearance of a building or any element of the historic environment and therefore may require planning permission, or conservation area or listed building consent.

- 7.4 You will generally need planning permission for:
- a new shopfront;
  - alterations to an existing shopfront including awnings and canopies, external security shutters, blinds, grilles and security measures; and
  - change of use will generally require planning permission.
- 7.5 Planning permission is not normally required for routine maintenance works, such as redecoration or straightforward repairs. For further detailed guidance check with the Council.
- 7.6 Any alterations (or replacement) of shopfronts that form part of a listed building will require Listed Building Consent and will need to be consistent with the age and style of the building. For further information see the chapter 3 Heritage of this CPG. More stringent controls will apply for the following works:
- re-painting a shopfront in a different colour,
  - installing a security alarm or extractor fan,
  - altering the shop interior,
  - installing blinds or shutters, and
  - advertisements.
- 7.7 Conservation Area Consent is required for the proposed complete or substantial demolition of any building in a conservation area. This includes the removal of a shopfront or of any feature that gives character to a building. In assessing applications to alter shopfronts within conservation areas special attention will be given to the desirability of preserving and enhancing the character and appearance of the Conservation Areas (for further information see chapter 3 Heritage of this CPG).
- 7.8 For shops in conservation areas, reference should also be made to the relevant Conservation Area Statement/Conservation Area Appraisal & Management Strategy (there are 39 in total). These describe the area and its special character and include guidelines that provide the framework for development proposals in the area and the appraisals contain audits of shopfronts of merit.
- 7.9 Advertisement consent is a separate procedure that applies to the display of advertisements on shopfronts. You can find further guidance in the document Outdoor advertisements and signs: A guide for advertisers (CLG, 2007) and chapter 8 'Advertisements, signs and hoardings' of this CPG).

#### **BUILDING REGULATIONS APPROVAL**

You need building regulations approval for all work which alters the shop's structure, entrance arrangement, changes its fire escape, or affects the level of access currently provided.

## Guidance for Shopfronts

### Design and appearance of shopfronts

7.10 The basic architectural features that make up shopfronts are illustrated in Figure 8.

Figure 8. Shopfront elements

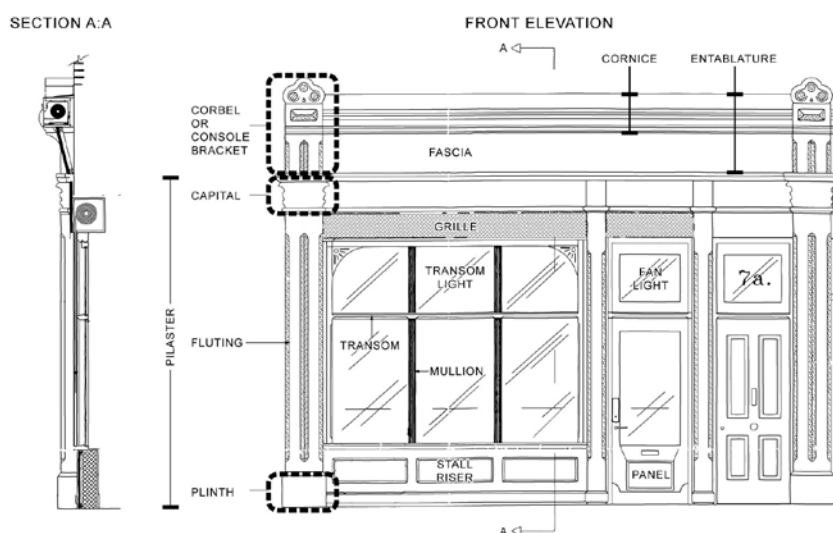

### General principles

7.11 Shopfront alterations should respect the detailed design, materials, colour and architectural features of the shopfront and building itself, the following will need to be considered:

- Historic, locally distinctive or characteristic shopfronts which contribute to the townscape should be retained. In some cases the reinstatement of missing features will be encouraged.
- New shopfronts should be designed as part of the whole building and should sensitively relate to the scale, proportions and architectural style of the building and surrounding facades.
- Shopfronts forming part of a larger new development should be considered as an integral part of the overall design.
- Standardised “house-style” frontages may have to be amended in order to harmonise with the surrounding context and respect the building, particularly in conservation areas and for listed buildings.
- All shopfronts should be designed to provide access into the premises for all.

## Key shopfront components

- 7.12 The following are key shopfront design components you need to consider when making alterations to an existing shopfront:

### Window Displays

- The window display is the main visual element of a shopfront. Shop frontages should be largely glazed to maintain a window display rather than creating a solid frontage (including obscured glass) which will be discouraged.
- On traditional shopfronts large expanse of undivided glass should be avoided. Vertical glazing bars (mullions) should be used to subdivide large windows to help visually relate the shopfront with the upper elevations of the building.

### Entrances

- The design of the door should be in keeping with the other elements of the shopfront. The solid bottom panel should align with the stallriser. The top of the door should align with the transom.
- Decorative tiling should be retained.
- All new build shop units and shopfronts should be designed to be fully accessible to everyone.
- In the case of existing buildings, particularly where a new shop front is proposed, the following guidance should be followed:
  - Shops that have a change in level from pavement to shop floor surface can usually incorporate ramped access into or within the shop. Exceptions preventing a ramped area to be created may include the presence of structural beams or floor slabs..
  - Entrance doors should be accessible to all, particularly wheelchair users and people with limited manual dexterity. 1000mm minimum clear door width in new buildings and 775mm door width in existing buildings where a new shop front or alterations to a shop front are proposed.
- to ensure that services are reasonably accessible to disabled people refer to Camden Planning Guidance on Access for all.

### Shopfront recess

- Where there is an existing shopfront recess - often found in older traditional shopfronts e.g. listed buildings and conservation areas - they should be retained.
- Traditional horizontally-operated lattice security gates can in some cases be employed to protect recessed shop entrances, but they should not extend across windows. On traditional shopfronts, removable timber or metal lattice style shutters is often more appropriate.
- New recesses in shopfronts will be strongly discouraged due to their potential for attracting anti-social behaviour.

## Fascias

- The fascia should be of a suitable size and proportion in relation to the building and should not normally extend above the cornice or below the capital as it would upset the overall balance and proportions of a shopfront or parade (see Figure 9 and Figure 10).
- Fascia signs should not obscure or damage existing architectural features. Deep box fascias which project beyond the shopfront frame should be avoided.
- Lettering on fascia signs should be proportionate to the scale of the shopfront. To aid identification, fascia signs should include the street number of the premises.
- Where a shopfront and fascia extend across two or more shop unit bays, the removal of intervening pilasters are not acceptable as it would:
  - weaken the frame's visual support to the upper floors; and
  - disrupt the character and rhythm of a shopping frontage created by the widths of individual shopfronts.
- Lettering on fascia signs should be proportionate to the scale of the shopfront. Main fascias should also be of a suitable size and proportion in relation to the building and should sit between cornice and shopfront itself and should not project above or below the cornice level obscuring upper floor or shop windows.
- Fascia and box signs should not obscure or damage existing architectural features.



Figure 9. Good shopfront section and elevation

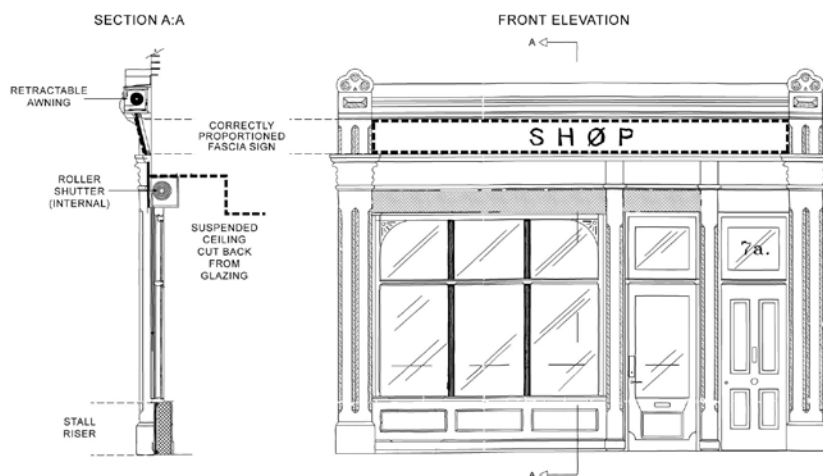
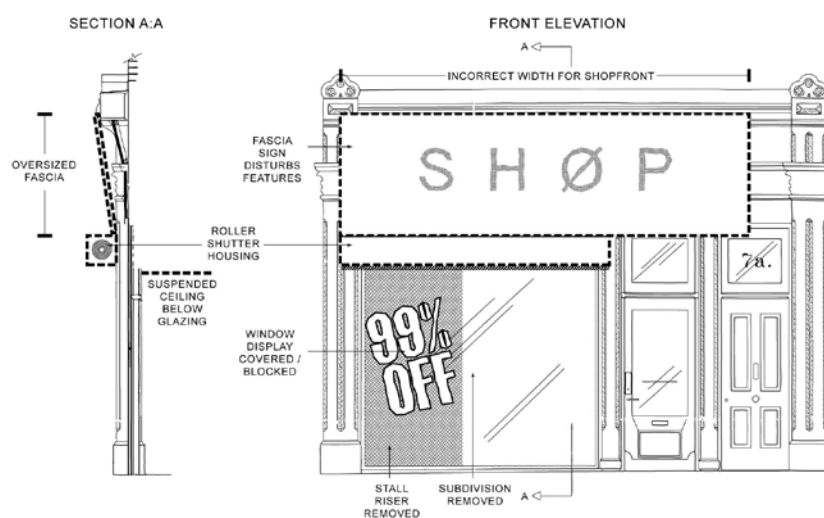

Figure 10. Inappropriate shopfront section and elevation



### Pilasters

- New pilasters are preferably placed in line with solid wall, not windows above, to emphasise their function. This is particularly important in the case of shopping frontages on sloping sites where existing stepped profiles of fascias and stallrisers should be preserved or reintroduced wherever possible.

### Stallrisers

- Stallrisers consist of solid elements below shop windows. They form a base to the shopfront display, and prevent the glazing from being damaged or soiled.
- Stallrisers should be retained and generally incorporated to any new shopfront on a period buildings.

- Where stallrisers are provided, they should be at least 300mm high or to the top of the pilaster base or door panel and faced in appropriate materials for the context. They should not provide ledges that can be sat upon. Glazing should be brought to the front of a stallriser.

### **Colour and materials**

- Materials should be chosen for their durability and appropriateness to their location. Traditional materials such as timber, stone and render are the most appropriate for new shopfronts, particularly for listed buildings and in conservation areas.
- More contemporary materials such as colour-coated steel, aluminium and bronze instead of timber may be appropriate in some circumstances.
- Existing glazed brickwork or tiling should be retained.
- Colour schemes for shopfronts and in particular the projecting framework should be carefully considered, particularly in conservation areas and for listed buildings.
- Proposals should be accompanied by full details of materials, finishes and colours (or sample and specification cards).

### **Folding shopfronts**

- Folding shopfronts are not generally acceptable, particularly those on historic buildings such as listed buildings and those in Conservation Areas. When open, they erode the appearance of the shopfront, creating a visual void, and can increase disturbance to neighbouring properties, particularly in the case of food and drink premises. When closed they appear as a row of doors rather than a shopfront. This creates a heavier appearance than a shopfront mullion and reduces the area of glass in the shopfront.

### **Lightwells / grilles**

- Pavement lights or small lightwells covered with metal grilles are typically found in front of shopfronts. These provide light into the areas beneath whilst allowing shoppers close inspection of the window display.
- Creating open lightwells with railings in front of a shopfront is not generally acceptable as it prevents window shopping and disrupts the buildings relationship to the rhythm of the street. This is also the case if the shopfront has been converted into residential accommodation.

### **Advertisements and signs**

- 7.13 Shops and businesses need to ensure that their name and other details are clearly displayed on their premises and, as a result, signs are among the most prominent forms of advertising on buildings. However, signs that are unsympathetically designed can cause significant harm to the building and the local townscape. Signs should relate well to the

character, scale and architectural features of the building and respect their local context.

- 7.14 Properties should only have one main fascia sign and one ancillary projecting or hanging sign per street frontage, although two projecting signs may be appropriate in cases of large shopfronts stretching across two or more shop units. Too many adverts/signs on a property contribute to visual clutter and can detract from the appearance of the street scene.

### **Projecting and hanging signs**

- 7.15 Projecting and hanging signs should normally be level with the fascia rather than below or above it. They should be positioned to the side of the shopfront at fascia level.
- 7.16 Signs at upper floor levels will be discouraged. Advertising for upper floor premises by lettering on windows or by suspended banners on large frontages will only be considered acceptable where advertising a specific event for a temporary period.
- 7.17 Advert signs - including those on canopies/blinds, should:
- be considered as an integral part of a shopfront or building, designed in from the outset with new structures;
  - be in harmony with the existing building, and neighbouring ones, in terms of their proportions, design and materials;
  - See Camden Planning Guidance on Advertisements, signs and hoardings.

### **Canopies, awnings and blinds**

- 7.18 Blinds can add colour and interest to the street scene. However, it is important to ensure that they do not dominate a shopfront or shop parade.

#### **Canopy**

A decorative structure providing a sheltered walk to the entrance of a building.

#### **Awning**

A sheet of canvas or synthetic fabric hung above a shopfront as protection against rain or sun

#### **Blind**

A structure of canvas or other material stretched used to keep sun or rain off a shop window.

7.19 Shopfront canopies and blinds are only likely to be acceptable where they are:

- retractable;
- traditional canvas;
- blind box integrated with the overall design;
- attached between the fascia and shopfront; and
- be flush with the fascia level.

Figure 11. Appropriate ways to install shopfront awnings

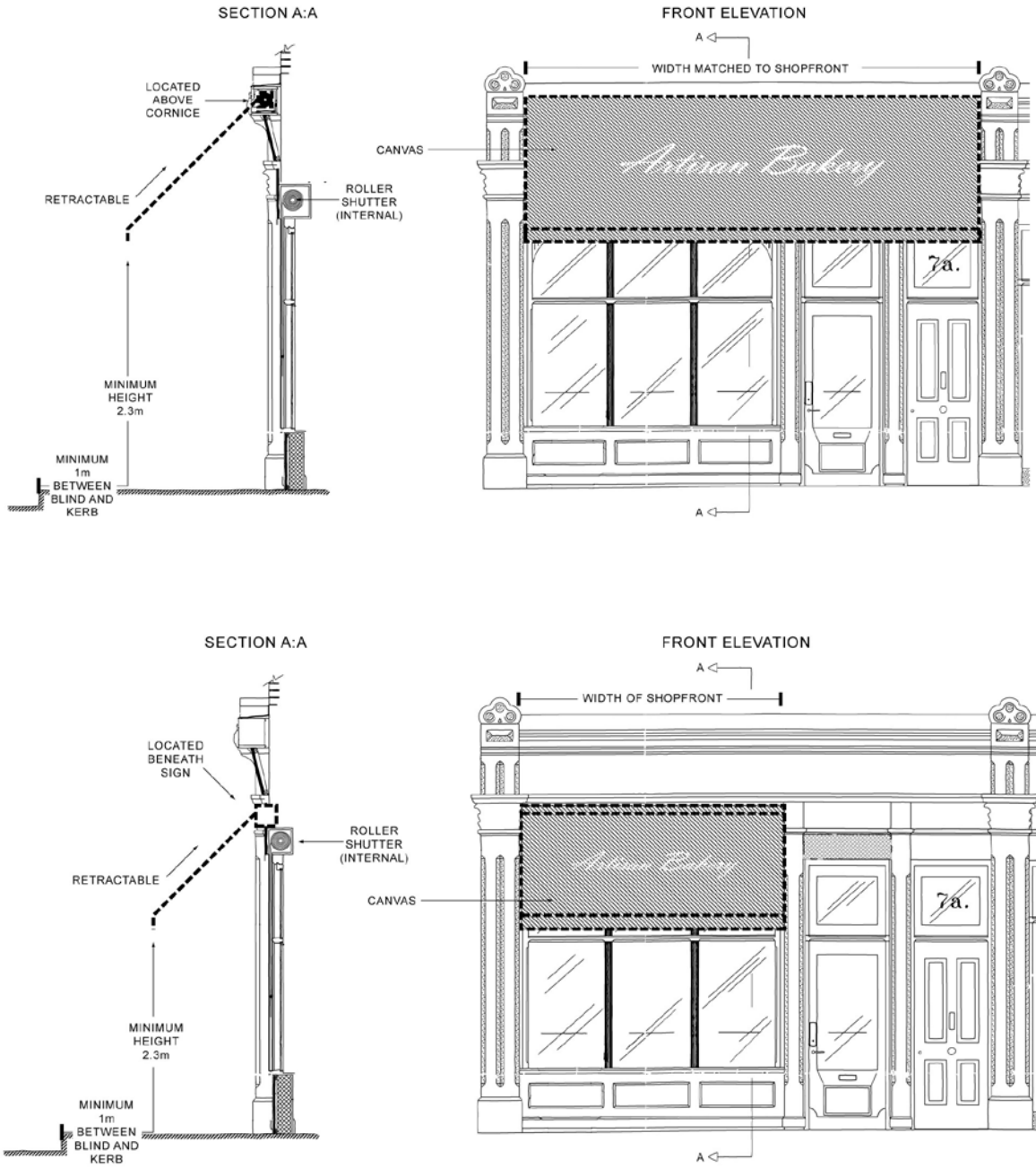

### Inappropriate ways to install shopfront awnings

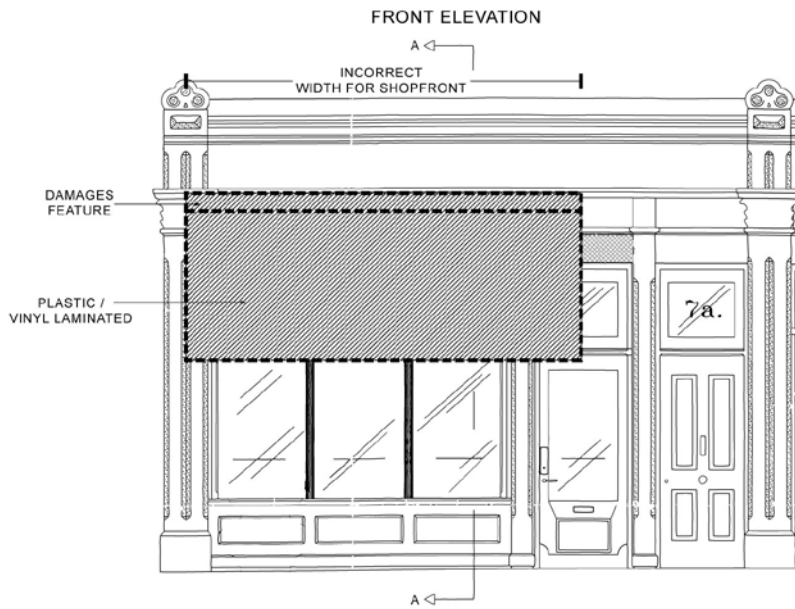
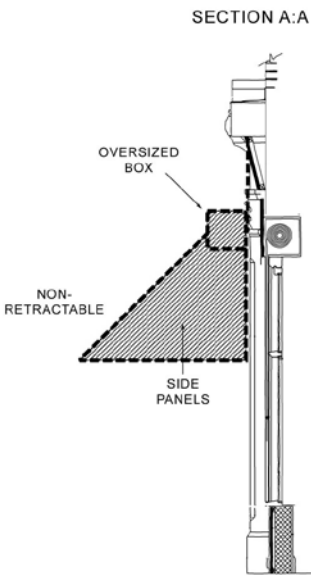
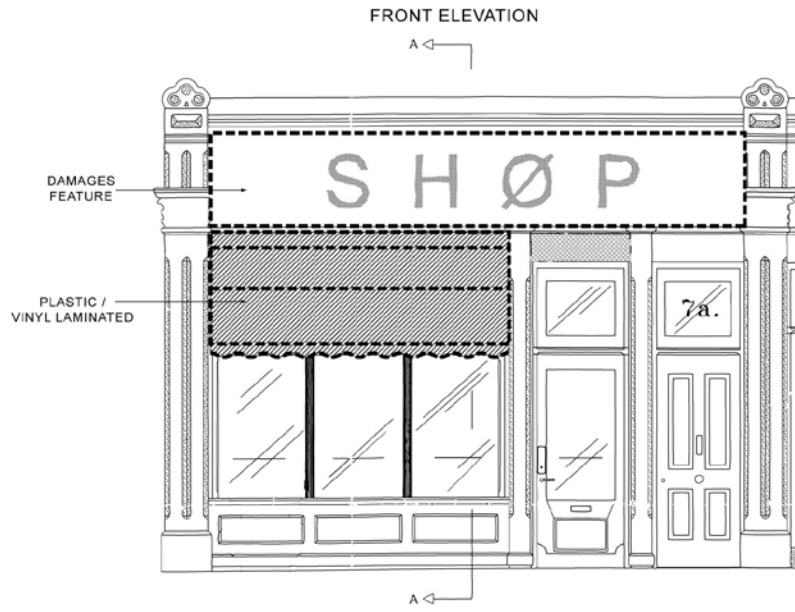
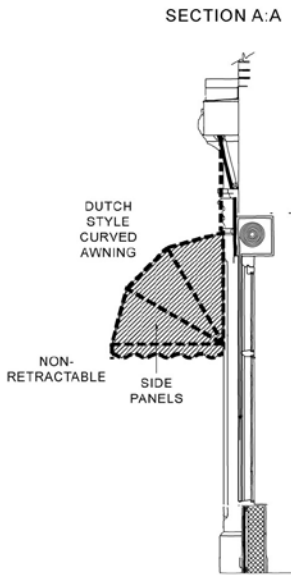

**Retractable**

- 7.20 Retracting awnings and blinds do not normally require planning permission, although they may require advertisement consent in certain cases. They should not:
- obscure or damage the fascia and other important features of the shopfront and buildings;
  - have discordant and over-dominant shapes, but be appropriate in position, design and materials to the character and scale of both the shopfront, building and locality.

**Fixed**

- 7.21 Fixed canopies, require planning permission. Acrylic / plastic “Dutch blinds”, or similarly reflective materials will be strongly discouraged, due to their bulk and materials and the resulting visual clutter.

**Materials**

- 7.22 Canvas blinds are often characteristic features of historic shopfronts and should therefore be retained or replaced using a similar design – acrylic or plastic blinds are not normally suitable.

**Signage**

- 7.23 Canopies or blinds with signage (a letter or words for advertising purposes or not), they are treated as advertisements and therefore advertisement consent will be required rather than planning permission (See chapter 8 ‘Advertisements, signs and hoardings’ in this CPG).
- 7.24 In general all blinds should be designed and installed to:
- ensure public safety;
  - incorporate a minimum of 2.3 metres between the bottom of the blind and the pavement; and
  - incorporate a minimum of 1 metre between the blind and the kerb edge.

**Shopfront security**

- 7.25 Security shutters can be visually unattractive and create a 'dead', hostile appearance (especially out of opening hours), which can affect the commercial viability of an area and harm the pedestrian experience.
- 7.26 These guidelines offer suggest the most appropriate means of providing security protection while minimising impacts on the appearance of the shopfront, the building and the character of the area.

**Shutters**

- 7.27 The Council strongly encourages internal rather than external shopfront security measures. Other forms of enhanced shopfront security should



be considered instead of external shutters. For example, improved internal lighting, alarm systems, the use of toughened or laminated glass, etc. In cases where external measures (shutters, grilles or alarm boxes, etc) are proposed they would only be permitted where they do not harm the character of shopfronts, such as internal brick bond grilles or collapsible gates.

- 7.28 External security shutters will normally require planning permission, whilst internal shutters normally do not. Where internal shutters are installed they should be set back to leave a window display. In the case of listed buildings, the installation of any shopfront security measures, external or internal, will require listed building consent. On listed buildings, there will be a presumption against the use of external security shutters and grilles in favour of internal.
- 7.29 Where an external shutter is proposed it may only be considered acceptable provided it is integrated into the shopfront in terms of design, materials and colour. External measures should avoid using solid roller shutters. This includes the 'pin-hole' versions that rely upon internal illumination for any transparent effect. These designs have negative environmental impacts including:
- obscuring the shopfront and hiding window displays;
  - attracting graffiti;
  - preventing natural surveillance;
  - creating a hostile and unsafe appearance in streets and shopping centres; and
  - being visually unattractive.

### **Shutter boxes**

- 7.30 Shutter boxes should be discrete and should not project forward of the fascia or obscure any architectural features. They should be concealed wherever possible, for example set behind or within the fascia panel, the guide rails concealed within the frame of the shopfront and shutter should be close onto the stallriser.

### **Grilles**

- 7.31 Roller grilles are preferable to solid or pin-hole shutters as they provide security without obscuring window displays and allow views of the shop interior, which enhances surveillance and security.

### **Removable grilles**

- 7.32 Removable or collapsible grilles can be used internally or externally and in both cases allow a certain degree of visibility. These only require planning permission if installed externally. However, listed building consent will also be required for internal grilles in listed buildings.
- 7.33 Removable grilles are expected to remain in place only outside trading hours and should be stored inside at all other times. Any fixings should

be discretely placed and must not harm architectural features or mouldings.

- 7.34 Where there is a recessed entrance it is preferable to install 'Concertina style gate between the openings.

### **Finishes**

- 7.35 All grilles and shutters should have an acceptable finish. They should be coloured (painted, powder coated or stove enamelled) to match the rest of the shopfront, including signs. Uncoated shutters, galvanised steel, a milled finish or anodised aluminium are not considered acceptable finishes. In the exceptional cases where solid shutters are acceptable, original designs by artists will be encouraged provided they respect their location, particularly in Conservation Areas.

### **Burglar Alarms**

- 7.36 Burglar alarm devices must be sited so that they are both adequately visible as a deterrent but do not detract from the visual character of the shopfront.

### **Cash machines**

- 7.37 Cash machines require planning permission and, in the case of listed buildings, listed building consent. Illuminated advertising for cash machines should be discreet and is subject to advertisement consent.
- 7.38 Cash machines (also known as cash points and ATMs) are only likely to be acceptable provided they are:
- treated as an integral part of a building's design wherever possible;
  - not dominant in the shop display frontage in terms of size or materials;
  - positioned sensitively and not be located where queuing could cause problems;
  - with minimal amount of display material;
  - located on the busiest elevation of a building to reduce the risk of robbery;
  - fully accessible to disabled people in both location and detailed arrangement; and
  - in existing bank buildings of traditional design they are most successfully inserted into existing stone recesses or beneath window bays.

### Further information

- 7.39 English Heritage has also prepared guidance on heritage assets within:
- English Heritage – ‘Easy Access to Historic Buildings’ 2012 - [www.english-heritage.org.uk](http://www.english-heritage.org.uk)
  - English Heritage – ‘Easy Access to Historic Landscapes 2013 - [www.english-heritage.org.uk](http://www.english-heritage.org.uk)
- 7.40 For further guidance on how to make shopfronts more accessible to all users as well as disabled users, see:
- The Disability Rights Commission publication “Making access to goods and services easier for disabled customers: A practical guide for businesses and other small service providers
  - BS 8300:2009+A1:2010 ‘Design of buildings and their approaches to meet the needs of disabled people’ – Code of Practice’ (BSI)
  - Inclusive Mobility – A guide to best practice on Access to Pedestrian and Transport Infrastructure, 2005 (Dept for Transport).



## 8 Advertisements, signs and hoardings

### KEY MESSAGES

In general, the most satisfactory advertisements are those which take into account:

- the character and design of the property;
- the appearance of the surroundings; and
- the external fabric of the building.

- 8.1 The purpose of this guidance is to provide advice on the design and siting of advertisements so that they contribute positively to the appearance and character of an area. All advertisements affect the appearance of the building, structure or place where they are displayed, to the extent that they can sometimes be the most dominant feature in an urban setting.
- 8.2 This guidance relates to Core Strategy Policy CS14 Promoting high quality places and conserving our heritage and Development Policies DP24 Securing high quality design and DP30 Shopfronts.
- 8.3 This guidance applies to all advertisements requiring advertisement consent, i.e. those which do not have “deemed consent” under the regulations.

### DEEMED CONSENT

This allows the display of certain "specified classes" of advertisement without first having to make an application to the local planning authority

- 8.4 Guidance on advertisements is also contained within Outdoor advertisements and signs: A guide for advertisers (CLG, 2007, [www.communities.gov.uk/publications/planningandbuilding/outdooradvertisements](http://www.communities.gov.uk/publications/planningandbuilding/outdooradvertisements)). Where advertisements have deemed consent and do not require formal advertisement consent the guidance in this document should still be applied as a matter of good practice. Reference should also be made to chapter 7 Shopfronts, in this guidance, and the Fact Sheet on Estate agent boards.

### What advertisements and signs are acceptable?

- 8.5 Good quality advertisements respect the architectural features of the host building and the character and appearance of the surrounding area. As a general guide, the most satisfactory advertisements are those which take into account the character and design of the property, its surroundings and alter the external fabric of the building as little as possible.

### All advertisements

- 8.6 Advertisements and signs should respect the form, fabric, design and scale of the host building and setting. All signs should serve as an

integral part of the immediate surroundings and be constructed of materials that are sympathetic to the host building and the surrounding area. Interesting and unique styles of advertisements and signs will be considered acceptable where they are compatible with the host buildings and surrounding environment.

- 8.7 Generally advertisements will only be acceptable at fascia level or below. Advertisements above fascia level can appear visually obtrusive and unattractive and, where illuminated, they can cause light pollution to neighbouring residential properties. If an advertisement is required at high level for a specific business use then this will usually be restricted to non illuminated images on windows.

**Fascia**

Runs horizontally across the ends of the roof rafters, below the lower edge of the roof.

- 8.8 Advertisements will not be considered acceptable where they impact upon public safety, such as being hazardous to vehicular traffic (e.g. block sight lines, emit glare) or pedestrian traffic (e.g. disrupt the free flow of pedestrian movement).
- 8.9 Advertisements in conservation areas and on or near listed buildings require detailed consideration given the sensitivity and historic nature of these areas or buildings. Any advertisements on or near a listed building or in a conservation area must not harm their character and appearance and must not obscure or damage specific architectural features of buildings.

**Advertising on street furniture**

**Street furniture**

A collective term for objects on streets and roads, including benches, bollards, post boxes, phone boxes, streetlamps, traffic lights, traffic signs, bus stops etc

- 8.10 Free standing signs and signs on street furniture will not normally be accepted where they contribute to visual and physical clutter and create a hindrance to movement along the pavement or pedestrian footway.

**Illumination**

- 8.11 The illumination levels of advertisements should be in accordance with the standards set by the Institute of Lighting Engineers Technical Report Number 5 (Second Edition).
- 8.12 The type and appearance of illuminated signs should be sympathetic to the design of the building on which it is located. The method of illumination (internal, external, lettering, neon, etc) should be determined by the design of the building. Illuminated signs should not be flashing or intermittent, whether internal or external.

- 8.13 Externally illuminated signs should be unobtrusively sized and sited. Spotlights and trough lights should be fixed and sized as discreetly as possible. Corporate designs involving internally illuminated signs may need to be modified where they are considered unsuitable, especially in residential areas, or conservation areas, or on listed buildings.

**Trough lighting**

An enclosed sign lighting unit using high powered fluorescent tubes.

- 8.14 To ensure that an advertisement does not become unduly dominant in the streetscene, disturb adjoining residents at night, or cause safety hazards to drivers, consideration should be given to the:

- intensity of illumination;
- surface area to be illuminated; and
- positioning and colours.

- 8.15 Internally illuminated box signs are discouraged. Generally, the internal illumination of individual letters, rather than the whole fascia or projecting sign on a shopfront, will be more appropriate.

### **Hoardings**

**Hoarding**

A billboard or large outdoor signboard.

- 8.16 Where advertisement consent is required for the display of hoardings, the following guidance will be applicable:
- 8.17 Advertisement hoardings or posters will not usually be acceptable in predominantly residential areas and will be carefully controlled in conservation areas and on or near listed buildings to ensure that they do not detract from the area's and building's character and appearance. However, if an area has a mix of uses or is predominantly in commercial use some poster or hoarding advertising may be acceptable where they satisfactorily relate to the scale of the host building or feature and its surroundings. They should be designed and positioned as an integral feature of the building. Some guidelines on when hoardings will not be considered acceptable include:
- in locations where they may prevent or significantly damage views or obscure light;
  - where they are forward of the face of adjoining buildings;
  - where they project above roof ridge/eaves level;
  - where they obscure architectural features or landmarks (including windows or window recesses); and
  - on side walls where they would be unduly dominant.
- 8.18 Temporary poster hoardings used to screen buildings or construction sites while work is being carried out have deemed consent under the 2007 Regulations (please refer to Class 8 in the regulations for specific



details) for commercial, industrial or business uses only. This deemed consent is not available for any residential development and is also not available in conservation areas.

- 8.19 The impact of illumination will be taken into consideration and where it is considered to be a nuisance or out of character with the area then it will not be considered acceptable.

### **Shroud / banner advertisements**

#### **Shroud advertisement**

Large scale advert, covering an entire building elevation, often used to shield construction work.

- 8.20 Shroud advertisements come in a range of forms but are generally large-scale and can cover the entire elevation of a building. As a result of the scale and size of shroud advertisements their appearance can create a conflict with the surrounding environment and the streetscene and, where the advertisement partially obscures a building, the visual appearance of the building itself. However, they can help to shield unsightly construction work.
- 8.21 Conservation areas and listed buildings are particularly sensitive to these types of advertisements as they can appear overwhelming, and disrupt the appearance of a high quality built environment. Therefore, given the scale and size of shroud advertisements these types of advertisement proposals will only be considered acceptable primarily in commercial areas and only where they screen buildings under construction, alteration or refurbishment. If considered acceptable they will be allowed for a temporary period and should be removed on completion of the works should they be sooner than the approved period. Longer consents will require additional advertisement consent.
- 8.22 Shroud on scaffolding will only be permitted where:
- The scaffolding covers the entire elevation of the building and the netting on the scaffolding contains a 1:1 image of the completed building which is undergoing construction work (scaffolding is only to be erected for the purposes of carrying out building works and will be removed upon completion of the works); and
  - The advertisement covers no more than 20% of each elevation and is not fragmented. The advertisement must also respect the architectural form and scale of the host building. Where shroud and banner advertisements are considered acceptable on listed buildings or in conservation areas the advertisement should not cover more than 10% of each elevation and should not be fragmented. The location of the advertisement on the shroud will depend on the character of the local built form and the nature of views within it.
  - In some highly sensitive locations or where the building plays a particularly important role in the appearance of the area, a visual representation of the building that is shrouded may be considered necessary to mitigate any harm to the appearance of the area.

- 8.23 Banner advertisements on buildings will only be permitted where:
- They relate to landmark or unique buildings, such as festival venues, museums, and do not detract from the appearance and form of the host building or the surrounding environment.
  - In some commercial areas flags or banners may be considered a suitable form of display. Within residential areas, conservation areas, and on or near listed buildings we will be primarily concerned with safeguarding the amenity, character and appearance of these areas and buildings and therefore it is unlikely that such advertisements will be supported.
- 8.24 NB: The erection of a banner or shroud advertisement may require a specific licence from our Highways Management Team. If advertisement consent is granted for a banner or shroud, this does not indicate that a licence will also be granted. The Highways Management Team should be contacted for more information. For information on licences please contact the Camden Highways Management Team.



**Designing out crime**

A method of minimising crime by designing or organising the environment in such a way that the opportunity for crime is reduced and potential offenders feel exposed and uncomfortable.

9.6 Good urban design will significantly reduce opportunities for crime and anti social behaviour. Security features should be considered early in the design process as it can be more difficult to incorporate features in a sensitive way at a later stage. It is important to take a proactive approach at an early stage to reduce risks and opportunities for crime and ASB to occur, rather than relying on reactive measures such as CCTV, which should be used as part of a package of measures to reduce crime. Incorporating designing out crime features into a development should complement other key design considerations. High quality architecture and design should still be achieved.

9.7 You should consider:

- good urban design principles, including active frontages to buildings and interesting and innovative design treatments that can reduce the need for physical barriers;
- using a local assessment of design to ensure that places are both well connected and secure;
- the effect of designing against crime on properties adjacent to and in the vicinity of a development, and the personal safety of people who will use the locality; and
- avoiding a 'fortress approach' as it tends to be unattractive and can result in an oppressive environment for both residents and passing pedestrians.

**Active frontage**

Building frontages which add interest and life to public spaces, through the use of doors and windows or shopfronts and lively uses.

9.8 We expect developments to reflect the considerations contained within the publication Safer Places – The Planning System and Crime Prevention (ODPM April 2004). This identifies seven attributes of sustainable communities that are particularly relevant to crime prevention. Therefore, we expect the following elements to be considered in planning proposals:

Access and movement	to, from and within any development
Structure	layout, type and design of buildings, and of public space
Surveillance	maximisation of overlooking, lighting, the promotion of active frontages and through the introduction of crime prevention measures
Ownership	clear delineation between public, communal, semi-private and private space
Physical protection	strengthening of the security of building in order to reduce or minimising the risk of attack or theft
Activity	compatible mix of uses and attractiveness and sustainability of any public realm components
Management and maintenance	inclusion of details of management and maintenance systems where appropriate

- 9.9 We require a crime impact assessment as part of the Design Statement to be included with all applications of 10 residential units or more or for sites of 1000 sq m or more. This should demonstrate that any impact on crime and antisocial behaviour has been considered, addressed and where appropriate designed out. For smaller schemes it will be expected that designing against crime principles will be incorporated into the scheme. These designing against crime principles are set out in Safer Places: The Planning System and Crime Prevention, ODPM, 2004.

**Design Statement:**

Documents that explain the design thinking behind a planning application. They should show that you have thought carefully about how everyone will be able to use the places you want to build.

### Addressing Community Safety Concerns

- 9.10 To enhance community safety, we would like to see developments consider:
- maximising accessibility by encouraging usage of safe routes to, from and through developments;
  - the design and layout of pedestrian, cycle and vehicular routes into and within the site, including how these integrate with existing patterns; and
  - lighting and the use of CCTV where appropriate, accessibility and ease of movement through a development scheme, which can enhance overlooking, thereby reducing the opportunity for crime and anti-social behaviour and increasing perceptions of personal safety.

### Movement and Gating

- 9.11 Gating can be seen as a solution to problems of crime and anti social behaviour. Gating and other ways of restricting access to developments

can have a divisive effect on communities, creating separate residential areas and often necessitating long alternative routes. It can create and reinforce negative perceptions of an area and for these reasons gating should be seen as a last resort.

- 9.12 We expect that developments will demonstrate the accepted principles of good urban design as laid out by the Commission for Architecture and the Built Environment (CABE) in 'By Design', a companion guide to Planning Policy Statement 1, which sets out the 7 objectives of urban design. One of these that is particularly relevant to movement and gating is "Ease of movement – a place that is easy to get to and move through. To promote accessibility and local permeability by making places that connect with each other and are easy to move through, putting people before traffic and integrating land use and transport."
- 9.13 We will not support applications for restricting access to, from or gating of, the public highway or designated open spaces that are currently accessible to the public. All applications which seek to reduce access to, from or through the public spaces will need to:
- explain clearly the rationale for the reduction in access and be able to demonstrate that it is an appropriate solution, which minimises negative impacts in, adjacent to and in the vicinity of the development;
  - provide evidence of anti-social behaviour and crime to support the proposed restricted access; and
  - demonstrate the alternative steps they have taken to address the problems.
- 9.14 We will consider whether the proposed restriction will:
- have an adverse impact on accessibility in the local area by reducing the opportunity for local people to use established routes. For further information refer to CPG4 Protecting and improving the quality of life (Access for all chapter);
  - result in the loss of natural surveillance by neighbours and passers-by thereby increasing the opportunity for crime and anti-social behaviour;
  - necessitate long alternative routes to take account of the proposed restriction;
  - have an adverse impact on the community cohesion and security of the local environment by creating separate residential areas;
  - have an unacceptable adverse impact on the safety or perception of safety adjacent to and in the vicinity of the development;
  - prevent the type of anti-social behaviour crime evidenced by the applicant; and
  - prevent unauthorised entry into the development.
- 9.15 In all cases we will consider time limiting permissions for gating, thereby allowing flexibility should any incidents of crime and anti-social behaviour decrease.

- 9.16 Rather than gating we wish to see developments enhance community safety by maximising accessibility through encouraging the usage of routes to, from and through development. Good design, lighting, the use of CCTV where appropriate and public accessibility can reduce the opportunity for crime and anti-social behaviour.

### **Licensed premises and alcohol related violence**

- 9.17 Licensed premises, because of their nature can be the location of alcohol related violence. This can be limited by good design, employing open layouts and maximising natural surveillance where possible. Where an application is received for alterations to new or existing licensed premises, we will seek to:

- maximise visibility into the premises by ensuring, where possible, clear glass is used on all street elevations; and
- reduce the number of entry points to a minimum.

### **Recesses**

#### **Recesses**

Set-backs in the line of building frontages.

- 9.18 Recesses, including recessed doorways, can provide the opportunity for anti-social behaviour and can have an impact on crime and the perception of crime.
- 9.19 In consultation with our Building Control Service and the Fire Authority, opportunities can be taken to reduce the number of emergency exit doors within recesses or minimise their impact. Bringing the doors forward should be investigated when schemes are being designed, by:
- allowing the doors to open inwards, where there are 60 users or less of emergency exit doors and it is not a licensed premises;
  - allowing the door to continue to open outwards if there is a private forecourt which it can open onto. Measures must be put in place to divert pedestrians away from the opening arc of the doors; and
  - allowing for the outward opening of the door where there are 60 or more users and the footway is very wide.
- 9.20 Where bringing the doors forward is deemed unacceptable, it should be ensured that:
- the recess is no deeper than 600mm or no greater than required for the opening of the door within the recess;
  - the edges of the recess are angled to improve visibility;
  - transparent elements are incorporated into the door;
  - the recess is widened so that it does not create hidden spaces; and
  - where appropriate and if the building is unoccupied for periods of time, open-weave grille shutters or collapsible gates are installed, to be opened when the building is occupied.



- 9.21 In all circumstances, overlooking of the recess should be maximised where possible by considering replacing the emergency exit door with an all glazed or top half glazed door with thick laminated glass. An open weave grille can be installed internally for additional security. Further guidance is contained within chapter 7 Shopfronts, in this guidance.

### **Walls and fences**

- 9.22 Careful consideration should be given to walls and fences, or other boundary treatments. If boundary walls are used in certain locations, where anti-social behaviour is identified as a problem, they should not have a flat horizontal top, which is inviting to sit on. Angled tops could be used to avoid the wall being used as an informal seat. Further guidance is contained within chapter 6 Landscape design and trees, in this guidance.

### **Public realm and street furniture**

#### **Street furniture**

A collective term for objects and pieces of equipment installed on streets and roads, including benches, bollards, post boxes, phone boxes, streetlamps, traffic lights, traffic signs, bus stops etc

- 9.23 Well designed street furniture and public art in streets and public places can contribute to a safe and distinctive urban environment. Street furniture should not obstruct pedestrian views or movement or be positioned to encourage anti social behaviour.
- 9.24 All features within public space and elements of street furniture should be designed to make a positive contribution to community safety and discourage anti-social behaviour. Careful consideration should therefore be given to their location and detailed design.

### **Cash machine boxes**

- 9.25 Cash Machine boxes are stand-alone structures located on the footway, which house Automatic Teller Machines (ATMs). We will refuse the siting of these in areas of high crime. Permission will only be granted where the police designing out crime advisors believe that it would not act encourage crime or interrupt important sightlines. Where they are allowed, the design should ensure maximum visibility into and through the proposed structure. Please see chapter 7 Shopfronts, in this guidance for further information.

### **Telephone boxes**

- 9.26 Although we have only limited and discretionary control over the siting and appearance of public call boxes, we are consulted on the siting of new telephone boxes on the public highway. In all cases we will request that the provider demonstrates the need for the siting of the new facility. In certain areas of the Borough, public call boxes can be seen as crime generators and in these areas we will consider whether the proposed location will have an impact on crime levels.

- 9.27 All new phone boxes should have a limited impact on the sightlines of the footway. The size of the box or other supporting structure that the phone box is in should be minimised to limit its impact on the streetscene and to decrease the opportunities for crime and anti-social behaviour. There should be a minimum footway width of 2m adjacent to the phone box. Designs which are dominated by advertising space are not acceptable. Any advertising should not be placed where it significantly reduces natural surveillance or CCTV coverage of, or into, the call box. Designs should seek to maximise views into and through the phone box and along the footway.

### Lighting

- 9.28 Good lighting can have a number of benefits, including:
- enhancing the built environment by increasing the potential for natural surveillance;
  - reducing the opportunity for criminal activity to take place;
  - where crime does occur, increasing the likelihood of it being challenged and/or reported; and
  - ensuring that CCTV footage is of sufficient quality to assist in the detection of crime.
- 9.29 Where used inappropriately, however, it can result in light pollution which is intrusive and can have an impact on residential amenity. It can also result in pooling of light which means that pedestrians walk from areas well lit to those with little light. This impacts on their perceptions of their own safety and can influence the way in which they use their environment.
- 9.30 We will seek to encourage good quality lighting provision in all developments to use metal halide lamps or the equivalent and high quality refractors where appropriate to maximise the perception of colour and increase the controllability of where light falls. This will encourage uniformity of light provision. Uniformity of light is very important in people's perception of how well an environment is lit and has a greater impact than absolute lighting levels. It is also necessary for people with sight impairments, whose eyes adjust to different light levels more slowly than fully sighted people. Lighting should be designed so as to minimise glare and reflection problems.

#### **Metal halide lamp**

A type of light source used in a variety of applications which produces a large amount of quality light without being a huge, bulky light bulb.

- 9.31 Where lighting is provided to increase on-site security, this should not have an adverse effect on the perception of lighting levels in areas adjacent to the site and where possible should enhance this provision.
- 9.32 Mounting of lighting should be considered to ensure that it is resistant to vandalism and does not act as a climbing aid.

### Landscaping

- 9.33 Where landscaping is created it can be important to consider sightlines as the landscaping matures. There may be a requirement for a maintenance agreement to ensure that planting as it matures does not impact on sightlines or CCTV coverage.

### Maintenance

- 9.34 How an area is maintained can have a major impact on people's perceptions of crime and anti-social behaviour. Where a development creates public space we may seek to agree a management and maintenance plan with the applicant.

### Car parks

- 9.35 Applications for car parks should demonstrate that they are well lit and secured in order to discourage anti-social behaviour. Underground car parks in particular should be securely designed and access limited to users.

### Anti-terrorism

- 9.36 Terrorism can pose a very real threat in some areas of the borough. It is beyond the scope of this document to deal with these threats in detail but we will work with counter terrorism security advisors (CTSAs) on a case by case basis. Where appropriate the principles of the Government guidance, Crowded Places: The Planning System and Counter-Terrorism should be applied.

### Conservation Areas and Listed Buildings

- 9.37 Incorporating designing out crime features into a development should complement other key design considerations such as the character and appearance of conservation areas and listed buildings. Measures for designing out crime will require careful consideration in these often more sensitive settings and some may not be considered appropriate within conservation areas or within the setting of a listed building. In these cases imagination should be used to come to a sensitive alternative solution.

### Design and access statements

- 9.38 In situations where crime and anti-social behaviour is a concern, applicants should demonstrate within Design and Access Statements their understanding of the local issues relating to crime, and how the design will address them. In these situations, Design and Access statements should outline:
- Current levels of crime and anti-social behaviour in the immediate area;
  - Activity levels in the streets and public spaces at all times of the day and night;

- The extent of natural surveillance of neighbouring properties, streets and public spaces; and
- Any other relevant local characteristics.

### **Further information**

9.39 For further guidance on designing against crime:

- Safer Places: The Planning System and Crime Prevention, ODPM, 2004.



## Guidance on standards for waste storage

- 10.7 This section provides detailed guidance on the requirements for both internal and external recycling and waste facilities to ensure designs allow sufficient space for the storage of recyclable material and waste in developments. To encourage occupants to recycle, internal storage areas should be designed into each unit of a new development. This will enable occupants to segregate their waste into refuse and recyclables, and store it temporarily, until it can be transferred to external bins.

### Residential development of 6 dwellings or fewer

#### Space requirements

- 10.8 Residential development of 6 dwellings or fewer are usually serviced by a kerbside recyclables and waste collection. The designs for recycling and waste facilities need to provide sufficient internal and external storage areas for each unit, ensuring:
- that internal space is provided for recycling and refuse storage, comprising adequate space for a recycling receptacle (typically a green reusable box or bag), food waste caddy, and waste bin for non-recyclables. Kitchens and utility rooms are generally the most appropriate locations;
  - there is external storage for mixed (commingled) recyclables, organic kitchen waste and non-recyclable waste, providing space for the following:
    - a free-standing 140l or 240l wheelie bin for the storage of commingled recycling;
    - a free-standing kitchen waste caddy;
    - seasonal storage of garden waste i.e. in large hessian sacks;
    - a free-standing receptacle for the storage of refuse (should the developer or resident wish to purchase one, as the Council does not currently provide containers for refuse);
    - for details of container dimensions please see Figure 13, below.

### Residential development of 7 dwellings or more

- 10.9 Collection services for developments with 7 or more residential dwellings vary depending on the individual circumstances of the premises. For this type of development a kerbside collection is preferred, where possible. For external storage requirements, the guidance for residential development of 6 or fewer units should be used.
- 10.10 Where communal facilities are required (i.e. the dwellings will share central recycling and refuse bins), the following steps should be followed:
- 10.11 The table below can be used to calculate the total volume of all waste and recycling generated in a week:

Size of household	Number in development	Projected Weekly Waste per household	Waste produced from all households
Studio / one bedroom	A	100 litres	A x 100 = W litres
Two bedroom	B	170 litres	B x 170 = X litres
Three bedroom	C	240 litres	C x 240 = Y litres
Total Weekly Waste Arising			W+X+Y = Z litres

- 10.12 If there are more than six households in a block of flats we recommend the use of bulk bins. The standard Eurobins we use have a capacity of 1,100 or 1,280 litres. The minimum required can be calculated as below:

$$\text{Number of bulk bins required} = \frac{\text{(Z) litres (from Table 1)}}{1,100 \text{ litres (volume of bulk bin)}}$$

- 10.13 Provision of bins should at least be split equally between refuse and recycling including provision for food waste – e.g. if a building requires 4.5 x 1,100l bins, 2 should be for refuse and 2 for dry recycling, plus a 660l bin for food waste.

#### Space requirements

- 10.14 Internal storage: Bulk bins must be placed on smooth impervious material that is 100 mm thick to withstand the weight. If multiple bins are needed they are better kept in an enclosure. This discourages non-residents from using the bins and also improves the aesthetics of the development. The dimensions of bulk bins are given in the table below.



Figure 13. Storage containers and dimensions

Container Type	Use	External dimensions mm (H x W x D)
55l green box	Storage of mixed dry recycling by households without space for a wheelie bin. Can be stored internally or externally, collected from the kerbside.	350 x 390 x 585
45l reusable green bag	Storage of mixed dry recycling by households without space for a wheelie bin. Can be stored internally or externally, collected from the kerbside	350 x 300 x 450
7l kitchen caddy	Internal storage of food waste. Contents are then transferred to a larger outdoor caddy or communal food waste bin.	252 x 252 x 229
23l kitchen caddy	External storage and collection of food waste by households with a kerbside collection	405 x 320 x 400
90l white sack	Seasonal external storage of compostable garden waste	450 x 450 x 450
140l wheelie bin	External storage and collection of mixed dry recycling by households with a kerbside collection.	1070 x 580 x 550
240l wheelie bin	External storage and collection of mixed dry recycling by households with a kerbside collection	1070 x 580 x 740
500l Eurobin	Communal external storage and collection of food recycling for households with communal collections	1145 x 1305 x 745
1100l Eurobin	Communal external storage and collection of mixed dry recycling and refuse for households with communal collections	1370 x 1260 x 990

(NB: This list, including the bin dimensions, is subject to change. It is only to be used for preliminary design purposes)

- 10.15 Residents should not be expected to carry their waste more than 30 metres in the horizontal distance from their front door to the bin store.
- 10.16 The enclosure or chamber should be large enough to allow clearance of 150 mm between each bin and the walls.
- 10.17 There should be space in front of the bins to allow residents to easily access the bins when depositing waste.
- 10.18 If multiple bins are used then there should be sufficient space to rotate the bins in between collections.

- 10.19 The walls should be made from an impervious, non-combustible material that ideally has a fire resistance of one hour when tested to BS 476-21.
- 10.20 If a gate or door is added to the enclosure or chamber it should be metal, hardwood or softwood clad with metal. Ideally it should have a fire resistance of 30 minutes when tested to BS 476-22. The door frame should allow clearance of 150 mm either side of the bin, when it is being pulled out for collection. The door frame should be rebated into the reveals of the opening. There should be a latch or clasp to hold the door open while the collection process takes place.
- 10.21 Arrangements should be made for the cleansing of the bin stores with water and disinfectant. A hose union tap should be installed for the water supply. Drainage should be by means of trapped gully connected to the foul sewer. The floor of the bin store area should have a suitable fall (no greater than 1:20) towards the drainage points.
- 10.22 If the chambers are inside the building they should have a light. The lighting should be a sealed bulkhead fitting ( housings rated to IP65 in BS EN 60529:1992).
- 10.23 Internal bin chambers should have appropriate passive ventilators to allow air flow and prevent unpleasant odours. The ventilation must be fly and vermin proofed and near to either the roof or floor, but away from the windows of dwellings.

#### **Access for collections**

- 10.24 Collectors should not have to cart a bulk bin more than 10 metres from the point of storage to the collection vehicle.
- 10.25 The gradient of any path that the bulk bins have to be moved on should ideally be no more than 1:20, with a width of at least 2 metres, and the surface should be smooth.
- 10.26 If the storage area is raised above the area where the collection vehicle parks, then a dropped kerb is needed to safely move the bin to level of the collection vehicle.
- 10.27 The roadway the vehicle parks on should be able to accommodate the weight and size of a 26 tonne vehicle.

#### **Non-residential and commercial buildings**

- 10.28 Occupiers of commercial premises are legally obliged to make an arrangement with either the Council or a licensed waste carrier for the collection of the waste produced from the premises.
- 10.29 The volume of waste generated and thus the number and type of containers that a commercial development requires is ultimately dependent on the use of the building. Further information can be found on the Council's website:  
<http://camden.gov.uk/ccm/content/environment/waste-and-recycling/commercial-waste/duty-of-care.en>

- 10.30 Where an extension or change of use to an existing property is proposed, this may result in the removal of existing container storage areas, typically, to the rear of a property. This may be acceptable provided that an alternative storage area is designated as part of the proposed development, in line with this guidance. For external storage requirements, Figure 14: External Storage Requirements should be used.

#### Space requirements

- Internal collection and storage points should always be considered for all types of waste to maximise the amount of recyclable material.
- External storage must be provided in most cases. As a guide, approximately one cubic metre storage space is required for every 300-500sq m of commercial space (includes both recyclable and non-recyclable waste). Storage space must be designed to accommodate bins to hold this amount of waste, separated, and should be designed in consultation with the waste collection contractor.
- Waste and recyclables from residential and commercial components of a development must be stored separately, but they should be stored using the same container type to facilitate ease of collection.
- For a summary of external waste storage requirements see Figure 14

#### RESTAURANTS AND FOOD WASTE

Special consideration must be given to the location and nature of external storage areas. The volume of waste generated is generally high and has a high biodegradable content, therefore can potentially cause nuisance from odour, visual blight, and through attraction of vermin and scavengers. Storage of such waste should be in solid receptacles which ameliorate negative environmental impacts

Since 1st January 2006 developments that generate food waste have had to comply with the requirements of the Animal By-Products Regulations 2005. The Regulations place controls on the collection, handling, transport, storage and disposal of animal by-products, which includes catering waste. This may have implications for the design of the building and the waste containers required. Further information on The Animal By-Products Regulations 2005 should be sought from DEFRA – [www.defra.gov.uk/animalh/by-prods/default.htm](http://www.defra.gov.uk/animalh/by-prods/default.htm)

#### Location Requirements

- 10.31 The table below summarises the key external storage requirements. In particular, the first six features apply to all developments regardless of size and type of units.

Figure 14. External storage requirements

	<b>External storage area features:</b>	<b>Less than 6 residential units</b>	<b>7 or more residential units</b>	<b>Non-residential (commercial) Development</b>
1	Should not be located near ground storey windows. They should be located within 10 metres of an external access.	✓	✓	✓
2	External storage areas and collection points must be as close as possible to, and preferably within 10 metres of, a place suitable for a collection vehicle to stop.	✓	✓	✓
3	Storage facilities must be at or near street level, and should be accessible via appropriately sized and graded ramps to allow bins to be wheeled to and from the collection point easily.	✓	✓	✓
4	Must be safe for users by being well lit and visible from public vantage points and nearby dwellings / tenancies.	✓	✓	✓
5	Should be unroofed, unless they are fully enclosed and secured (ideally inaccessible to animals).	✓	✓	✓
6	Should be accessible for collection purposes and not impede pedestrian or vehicular access on public thoroughfares or to and from buildings.	✓	✓	✓
7	Should be located as close to the front property boundary as possible, preferably behind the front boundary wall, without detracting from the street scene.		✓	
8	Consideration should be given to the: <ul style="list-style-type: none"> <li>• allocation of additional external storage space in the future, e.g. additional bins,</li> <li>• composting facilities - in residential development with a garden or landscaping,</li> <li>• provision of onsite storage for bulky waste (i.e. furniture) items and potential opportunities for re-use of these items.</li> </ul>		✓	
9	Should be in an enclosed chamber that can be accessed from outside the building.			✓
10	Large developments in areas that are deficient in recycling banks (“bring”) facilities will be expected to incorporate these facilities onsite for use by the general public - must be located in secure and easily accessible communal areas,		✓	✓

### Additional Requirements

- 10.32 Applicants must provide details of storage for waste and recyclables in a proposed development as part of their application. These should be shown on the plans or in the application documents, where possible, and will form part of the approval
- 10.33 For schemes that create 7 or more dwellings, or includes a non-residential component, the applicant must consult Camden's Planning Department prior to making an application to determine the best means of storage and collection for the development. A statement describing the proposed waste storage and collection arrangements should be provided with the application.
- 10.34 For large proposals, or for proposals with complex waste separation or collection arrangements, a management plan might be required as a condition of approval.
- 10.35 Consideration should also be given to materials and finishes, and lighting of waste enclosures, to ensure that they are safe and secure, and do not present a fire hazard. These are dealt with in the Building Regulations.

### Further information

Camden Street Environment Services	Applicants are advised to contact Camden Street Environment Services in the first instant prior to making an application to determine the appropriate means of storage and collection required for a proposal  Address: Roy Shaw Centre 3-5 Cressy Road London NW3 2ND 020 7974 6914/5 <a href="http://www.camden.gov.uk/waste">www.camden.gov.uk/waste</a>
Waste storage requirements	Waste Storage : A Guide for Developers of Commercial and Residential Premises in the London Borough of Camden, Camden Street Environment Services  BS 5906 2005 Waste management in buildings – Code of practice, British Standards
Assistance with the identification of an appropriate company to deal with recyclable waste from the proposed development	Waste recycling <a href="http://www.wasterecycling.org.uk">www.wasterecycling.org.uk</a>  For free environmental guidance for small and medium-sized enterprises, see Environment Agency (NetRegs) <a href="http://www.environment-agency.gov.uk/netregs/default.aspx">www.environment-agency.gov.uk/netregs/default.aspx</a>

- plant and machinery on roofs should not be visible from the street, public vantage points or from immediately adjacent buildings;
- the design and materials used for plant, machinery and ducting, as well as for ancillary structures such as screening, where located on the exterior of the building, must be consistent with those of the building; and
- where possible, plant and machinery should be designed in such a way that does not lead to issues of safety and security.

### **Amenity**

- 11.8 Where ducting, plant or machinery are required on the outside of a building they must not obscure access to daylight and sunlight, or provide any nuisance for occupants of the development or adjacent buildings.
- 11.9 Plant and machinery with moving parts must be separated or insulated from occupants and neighbours who are likely to be sensitive to noise disturbance. Techniques to achieve this separation include the use of flexible ducting, or resilient mountings for structure-borne plant and machinery.
- 11.10 Where mechanical or passive ventilation is required to remove odour emissions, the release point for odours must be located above the roofline of the building and, where possible, adjacent buildings.

### **Sustainability**

- 11.11 Plant and machinery, particularly where located on roofs, must not preclude the installation of required onsite renewable energy facilities in the proposal. Consideration must also be given to the possibility of future renewable energy installations.

### **Conservation areas and listed buildings**

- 11.12 Special consideration should be given to the installation of plant, machinery and ducting on listed buildings and in conservation areas. Fewer external solutions are likely to be appropriate in these locations. Installations must be in keeping with the design and materials of the building. Listed building consent is likely to be required for works to a listed building.

### **Other considerations**

- Access to plant and machinery must be provided to allow for convenient and safe servicing and replacement of installations;
- Machinery must be properly installed and maintained to ensure that impacts are properly mitigated and the situation does not deteriorate over time with continued operation.
- Plant and machinery should be located as close as possible to their end use, e.g. boilers should be located near to the hot water or

heating users, to minimise use of ducting materials, loss of resource and visual blight.

- Disused plant, machinery and ducting must be removed from the exterior of buildings before replacements can be installed. Only in exceptional circumstances will these be allowed to remain.





## 12 Artworks, statues and memorials

### KEY MESSAGES

Applications for artworks, statues or memorials are only likely to be acceptable if they:

- meet the requirements of Camden's corporate guidance 'New statues, memorials and artworks in parks, open spaces and the public highway in Camden' and
- protect and enhance the local character and historic environment and contribute to a harmonious and balanced landscape design.

It may be inappropriate to site any artworks and memorials in some locations for contextual or historic reasons.

### Background

- 12.1 Camden is receiving an increasing number of applications for artworks, statues and memorials and there is a limited and reducing supply of suitable locations in the public realm and parks and gardens to accommodate new works. This guidance sets out the minimum requirements that Camden expects for applications for public art and all commemorative works including statues and memorials.

### Prior to submitting a planning application

- 12.2 Before applying for planning permission you should ensure your proposal meets the requirements of the corporate guidance, you should secure all the relevant permissions, and arrange sufficient funding including for ongoing maintenance. Details of this should be provided as part of your planning application.

### Corporate guidance

- 12.3 LB Camden has prepared corporate guidance entitled 'New statues, memorials and artworks in parks, open spaces and the public highway in Camden'. The guidance sets out what the council expects for artworks and memorials in the borough. The corporate guidance includes the following principles:
- **Site specificity and context:** The subject of an artwork, statue or memorial must have a clear historical or conceptual connection to the proposed location.
  - **20 year principle:** At least 20 years after the death of an individual or the date of the event should elapse before an artwork, statue or memorial is erected in commemoration.
  - **Protected areas:** Artworks, statues and memorials should not be sited in spaces which already have a high concentration of other artworks, statues or memorials. LB Camden Parks and Open Spaces have surveyed key artworks, statues and memorials across the borough

and identified areas where any further development of artworks, statues and memorials is unlikely to be appropriate. These have been identified in site survey documents for Council owned or managed land and also through mapping of the density (saturation) of artworks, statues and memorials across the entire borough. We are unlikely to grant permission for new artworks, statues or memorials where identified as inappropriate in site surveys or in areas mapped as having a high saturated or existing works.

- **Quality:** Statues and memorials must be of the highest quality, from an artist who has been selected through a robust and transparent selection process.

- 12.4 The Council will not grant planning permission for artworks, statues and memorials which are not generally in line with the corporate guidance.

### **Permissions and other legislation**

- 12.5 Prior to applying for planning permission you should you have all relevant permissions includes permission from the land owner and from leaseholders and managers of the land.

- 12.6 You should have regard to other legislation including:

- The Highways Act 1980: works affecting the public highway will require consent of the highway authority.
- Public Statues (Metropolis) Act 1854: Section 5 requires consent of the Secretary of State for Culture, Media and Sport, although this is generally provided as a matter of course if the scheme receives planning permission.
- The London Squares Preservation Act 1931 and Public Statues Act 1884 may be relevant to your proposal.

### **Funding**

- 12.7 You should ensure you have made arrangements for the ongoing maintenance of an artwork, statue or memorial. If the artwork, statue or memorial is on Council owned or managed land you are likely to be required to arrange funding to provide to the Council for maintenance of the work in perpetuity. If the work is on private land you are likely to have to be required to provide a maintenance plan as part of planning permission. You may be required to enter a legal agreement (such as s106 Agreement) to secure these measures.

### **Planning Permission**

#### **When is planning permission required?**

- 12.8 Depending on the size and location, construction or installation of an artwork or memorial may be constitute development under the Town and Country Planning Act 1990 and therefore require planning permission. Artworks or memorials which are outside or will materially alter the appearance of an area or building will generally require planning

permission. Any artworks or memorials on the interior of a building and which do not materially alter the outside appearance of the building are unlikely to require planning permission. If an artwork or memorial forms part of a larger development it should form part of the planning application for the entire scheme. Listed building consent will be required for any work to which affects the special architectural or historic character of a listed building or structure including internal or external alterations.

### **Assessment of applications for artworks and memorials**

- 12.9 Applications for planning permission for memorials and artworks will be assessed against the National Planning Policy Framework, Council's Local Development Framework (LDF) Core Strategy and Development Policies planning policy documents, the relevant Conservation Area Appraisal and Management Plan (if in a Conservation Area), and Camden Planning Guidance.

### **High quality design**

- 12.10 Core Strategy CS14 'Promoting high quality places and conserving our heritage' requires development to be of a high standard of design and respect local character. CS14 promotes high quality landscaping and works to streets and public spaces.
- 12.11 Core Strategy CS15 'Protecting and improving our parks and open spaces and encouraging biodiversity' states that Camden will protect and improve its parks and open spaces.
- 12.12 Development Policy DP24 'Securing high quality design' requires all development to be of the highest standard of design, and expects developments to consider the character, setting, context, form and scale of neighbouring buildings, the quality of materials used, natural features and landscaping. The policy encourages outstanding design in contemporary or traditional styles. The policy requires development to consider existing rhythms, symmetries and uniformities in the townscape, the compatibility of materials and their texture, tone and colour, the contribution of a design to views and vistas, and the wider historic environment and features.
- 12.13 This Camden Planning Guidance document sets out further design considerations, refer to page 7 for general guidance on design and refer to page 43 for guidance on landscape design and trees.

### **Conservation of heritage**

- 12.14 Core Strategy CS14 'Promoting high quality places and conserving our heritage' requires development to respect local character and requires development to preserve and enhance heritage assets including historic parks and gardens.
- 12.15 Development Policy DP25 'Conserving Camden's heritage' requires development take account of conservation area statements, appraisals

and management plans. Development will only be permitted within conservation areas which preserves and enhances the character and appearance of that area. The policy requires the preservation of trees and garden spaces which contribute to the character of the conservation area and protects parks and gardens of Special Historic Interest and London Squares.

- 12.16 If the artwork of memorial is in a Conservation Area you must refer to the relevant Conservation Area Appraisal and Management Plan which are available on [www.camden.gov.uk](http://www.camden.gov.uk).
- 12.17 This Camden Planning Guidance document sets out further heritage considerations, refer to page 13.

#### **Crime prevention through design**

- 12.18 Core Strategy CS17 'Making Camden a safer place' requires developments to demonstrate that they have incorporated design principles which contribute to community safety and security and promotes safer streets and public areas. This may include through design, lighting and management.
- 12.19 This Camden Planning Guidance document sets out further heritage considerations, refer to page 77.

#### **Further considerations for artworks and memorials**

- 12.20 In line with the LDF Core Strategy and Development Policies as summarised above new artworks and memorials will only be permitted where they preserve and enhance the character of the local area, historic environment and heritage assets. Further planning considerations of particular relevant to artworks, statues and memorials are set out below.

#### **Landscape design and over-saturation**

- 12.21 New artworks or memorials should only be sited where they contribute to a harmonious and balanced landscape design. Many of the public spaces in Camden particularly open spaces in Central London have limited opportunities for siting of new artworks or memorials. The existing and historic design of spaces must be respected and new structures should not be imposed where they would not complement or improve this existing landscape design. New artworks or memorials are unlikely to be acceptable in locations where there are a number of existing artworks or memorials. Siting of artworks and memorials should also take consideration of the corporate priority to keep the spaces free of clutter to allow unimpeded pedestrian access and for aesthetic considerations.

#### **Historic and thematic context**

- 12.22 Artworks and memorials will only be permitted where appropriate in terms of the history, context and purpose of a site. The history or context of a

space may make siting of artworks or memorials inappropriate even when it may be acceptable from design or aesthetic considerations. If a location (for example a garden or square) has been traditionally free from artworks or memorials the introduction of a piece can shift the emphasis and meaning of that space from being an open space in its own right to that of a landscaped setting for an artwork, statue or memorial. Due to the impact they have in changing the character of a space artworks, statues or memorials which form the centrepiece or focus to a space, particularly higher profile spaces such as Central London Squares are unlikely to be acceptable in all but exceptional circumstances (for example where there is overwhelming public support for a person or event of national importance). In line with the National Planning Policy Framework great weight will be given to the conservation of heritage assets and development leading to substantial harm to the significance of a designated heritage asset will be refused, unless it can be demonstrated that the substantial harm or loss is necessary to achieve substantial public benefits that outweigh that harm or loss.

### **Temporary artworks and memorials**

- 12.23 Temporary memorials provide a focus for community commemoration while being significantly less costly and time consuming to establish. Planning permission may still be required for temporary structures and you should contact to the Council at an early stage for advice.





## Index

Advertisements .....	73	Grilles (shopfront).....	69
Advertisements (shopfronts).....	63	Heritage .....	15
Alarms .....	70	Hoardings .....	75
Anti-social behaviour.....	79	Landscape design .....	45
Anti-terrorism .....	86	Licensed premises .....	83
Article 4 directions.....	18	Lighting.....	56
ATMs.....	<i>See</i> Cash Machines	Listed Buildings.....	20
Awnings.....	64	Mansard Roofs.....	38
Balconies.....	41	Paving of front gardens .....	51
Banner advertisements .....	76	Railings.....	53
Blinds.....	64	Rear extensions .....	<i>See</i> Extensions
Building services equipment 97, <i>See</i>		Rear gardens .....	<i>See</i> Gardens
Services		Recycling .....	89
Canopies .....	64	Refuse .....	89
Cash machine boxes.....	84	Roller grilles .....	<i>See</i> Grilles
Cash machines .....	70	Roof alterations and extensions..	35
Community Safety.....	81	Roof dormers .....	37
Conservation area statements....	19	Roof lights.....	41
Conservation areas.....	16	Roofs .....	35
Conservatories.....	31	Section 211 .....	48
Crime Prevention .....	80	Shopfronts.....	57
Cross overs.....	51	Shroud advertisements.....	76
Design and Access Statements..	13	Shutters .....	68
Doors.....	27	Side extensions.....	<i>See</i> Extensions
Dormers.....	37	Signs (general).....	73
Extensions .....	25	Signs (shopfronts) .....	63
Extensions (rear).....	29	Solar panels .....	42
Extensions (side) .....	30	Street furniture .....	84
External alterations .....	26	Tall buildings.....	12
External pipework .....	28	Telephone boxes.....	84
Fascias .....	61	Terraces.....	41
Fences.....	53	Tree preservation orders .....	48
Front gardens .....	<i>See</i> Gardens	Trees .....	45
Gardens.....	50	Trees in Conservation Areas .....	48
Gardens (front).....	50	Walls.....	53
Gardens (rear, development in)..	32	Window Displays.....	60
Gating.....	81	Windows .....	26
Green roofs (in roof design).....	42		