



ARBORICULTURAL IMPACT ASSESSMENT REPORT FOR:

9 St-Martins Almshouses
Bayham Street
London
NW1 0BD

INSTRUCTING PARTY:

Christian Knutson
9 St-Martins Almshouses
Bayham Street
London
NW1 0BD

REPORT PREPARED BY

Adam Hollis
MSc ARB MICFor FArbor A MRICS C Env

Ref: MOX/9STM/AIA/01

Date: 19th April 2017

The content and format of this report are for the exclusive use of the Instructing Party. It may not be sold, lent, hired out or divulged to any third party, not directly involved in the subject matter without Landmark Trees' written consent

Web: www.landmarktrees.co.uk
e-mail: info@landmarktrees.co.uk
Tel: 0207 851 4544



London Office: Holden House, 4th Floor, 57 Rathbone Place London W1T 1JU

Registered Office: 15 Abbey Road, Oxford OX2 0AD

Landmark Trees is the trading name of Landmark trees Ltd. Registered in Wales. Reg No. 3882076



PART 1: MAIN TEXT

Section	Content	Page No
1.0	SUMMARY	4
2.0	INTRODUCTION	5
3.0	OBSERVATIONS	7
4.0	DEVELOPMENT CONSTRAINTS	9
5.0	ARBORICULTURAL IMPACTS	12
6.0	DISCUSSION	13
7.0	CONCLUSION	16
8.0	RECOMMENDATIONS	17
9.0	REFERENCES	20

PART 2 - APPENDICES

APPENDIX 1	Survey Data	22
APPENDIX 2	Recommended Tree Works	27

PART 3 - PLANS

PLAN 1	Tree Constraints Plan	25
PLAN 2	Impact Assessment Plan(s)	29

Caveats

This report is primarily an arboricultural report. Whilst comments relating to matters involving built structures or soil data may appear, any opinion thus expressed should be viewed as qualified, and confirmation from an appropriately qualified professional sought. Such points are usually clearly identified within the body of the report. It is not a full safety survey or subsidence risk assessment survey. These services can be provided but a further fee would be payable. Where matters of tree condition with a safety implication are noted during a survey they will of course appear in the report.

A tree survey is generally considered invalid in planning terms after 2 years, but changes in tree condition may occur at any time, particularly after acute (e.g. storm events) or prolonged (e.g. drought) environmental stresses or injuries (e.g. root severance). Routine surveys at different times of the year and within two - three years of each other (subject to the incidence of the above stresses) are recommended for the health and safety management of trees remote from highways or busy access routes. Annual surveys are recommended for the latter.

Tree works recommendations are found in the Appendices to this report. It is assumed, unless otherwise stated ("ASAP" or "Option to") that all husbandry recommendations will be carried out within 6 months of the report's first issue. Clearly, works required to facilitate development will not be required if the application is shelved or refused. However, necessary husbandry work should not be shelved with the application and should be brought to the attention of the person responsible, by the applicant, if different. Under the Occupiers Liability Act of 1957, the owner (or his agent) of a tree is charged with the due care of protecting persons and property from foreseeable damage and injury.' He is responsible for damage and/or nuisance arising from all parts of the tree, including roots and branches, regardless of the property on which they occur. He also has a duty under The Health and Safety at Work Act 1974 to provide a safe place of work, during construction. Tree works should only be carried out with local authority consent, where applicable.

Inherent in a tree survey is assessment of the risk associated with trees close to people and their property. Most human activities involve a degree of risk, such risks being commonly accepted if the associated benefits are perceived to be commensurate.

Risks associated with trees tend to increase with the age of the trees concerned, but so do many of the benefits. It will be appreciated, and deemed to be accepted by the Instructing Party, that the formulation of recommendations for all management of trees will be guided by the cost-benefit analysis (in terms of amenity), of tree work that would remove all risk of tree related damage.

Prior to the commencement of any tree works, an ecological assessment of specific trees may be required to ascertain whether protected species (e.g. bats, badgers and invertebrates etc.) may be affected.

1.0 SUMMARY

Instructing Party:	Christian Knutson	Case Ref:	MXN/9STM/AIA/01
Local Authority:	LB Camden	Date:	18/04/2017
Site Address: 9 St-Martins Almshouses, Bayham Street, London NW1 0BD			
Proposal: Refurbishment and extension of existing property			
Report Checklist	Y/N		Y/N
Arboricultural constraints on site	Y	Trees removal proposed	N
Tree Survey	Y	Topographical Survey	N
BS5837 Report	Y	Conservation Area	N
Tree Preservation Orders	N/k		
Tree Protection Plan:	N/a	(Include in future method statement)	
Tree Constraints Plan:	Y		
Arboricultural Impact Assessment:	Y		
Site Layout			
Site Visit	Y	Date: 04/04/17	Access Full/Partial/None
			F
Trees on Site	Y	Off-site Trees	Y
Trees affected by development	Y	O/s trees affected by development	Y
Tree replacement proposed:	N/a	On or off-site trees indirectly affected by development	N
Trees with the potential to be affected			
Likely footprint of basement and ground floor rear extension encroach within RPA of T2 by 5.95%, assessed as being low impact to tree – manual excavation of top 750mm of basement line through RPA with pre-emptive root pruning proposed as mitigation. Re-landscaping of rear garden will require no-dig construction methodology and a permeable finished surface.			
Comments			
Felling of T1 recommended for sound arboricultural husbandry.			
Recommendations			
1	Proposal will mean the loss of important trees (TPO/CA)		N
2	Proposal has sufficient amelioration for tree loss		N/a
3	Proposals provide adequate tree protection measures		Y
4	Proposal will mean retained trees are too close to buildings		N
5	Specialist demolition / construction techniques required		Y
6	The Proposal will result in significant root damage to retained trees		N
7	Further investigation of tree condition recommended		N

RPA= Root Protection Area

TPP= Tree Protection Plan

AMS= Arboricultural Method Statement

AIA = Arboricultural Implication Assessment

BS5837: 2012 'Trees in relation to design, demolition and construction – Recommendations'

Arboricultural Impact Assessment Report: 9 St-Martins Almshouses, Bayham Street, London NW1 0BD

Instructing party:: Christian Knutson, 9 St-Martins Almshouses, Bayham Street, London NW1 0BD

Prepared by: Adam Hollis of Landmark Trees, Holden House, 4th Floor, 57 Rathbone Place, London W1T 4JU

2. INTRODUCTION

2.1 Terms of Reference

- 2.1.1 LANDMARK TREES were asked by Christian Knutson to provide a survey and an arboricultural impact assessment of proposals for the site: 9 St-Martins Almshouses, Bayham Street, London NW1 0BD. The report is to accompany a planning application.
- 2.1.2 The proposals are for the demolition of the existing non-original rear extension, erection of a new, glazed, basement plus ground floor rear extension of similar footprint. There will also be minor internal alterations and the addition of one skylight above the stairwell, replacement of the first floor terrace door with sash window. Remodelling of the existing patio and garden is also proposed.
- 2.1.3 This report will assess the impact on the trees and their constraints, identified in our survey. Although the proposals were known at the time of the survey, Landmark Trees endeavour to survey each site blind, working from a topographical survey, wherever possible, with the constraints plan informing their evolution.
- 2.1.4 I am a Registered Consultant and Fellow of the Arboricultural Association and a Chartered Forester, with a Masters Degree in Arboriculture and 25 years' experience of the landscape industry - including the Forestry Commission and Agricultural Development and Advisory Service. I am a UK Registered Expert Witness, trained in single and joint expert witness duties. I am also Chairman of the UK & I Regional Plant Appraisal Committee, inaugurated to promote international standards of valuation in arboriculture.

2.2 Drawings Supplied

- 2.2.1 The drawings supplied by the Instructing Party and relied upon by Landmark Trees in the formulation of our survey plans are:
- Existing site survey: MOX-599_001-Sheet – 599_101 – Existing Site Plan*
- Proposals: MOX-599_001-Sheet – 599_221 – Proposed Ground Floor Plan

*In the absence of a full topographical survey, tree positions may be approximate only.

2.3 Scope of Survey

- 2.3.1 As Landmark Trees' (LT) arboricultural consultant, I surveyed the trees on site on 4th April 2017, recording relevant qualitative data in order to assess both their suitability for retention and their constraints upon the site, in accordance with British Standard 5837:2012 Trees in relation to design, demolition and construction – Recommendations [BS5837:2012].
- 2.3.2 Our survey of the trees, the soils and any other factors, is of a preliminary nature. The trees were SURVEYED on the basis of the Visual Tree Assessment method expounded by Mattheck and Breloer (The Body Language of Trees, DoE booklet Research for Amenity Trees No. 4, 1994). LT have not taken any samples for analysis and the trees were not climbed, but inspected from ground level.
- 2.3.3 A tree survey is generally considered invalid in planning terms after 2 years, but changes in tree condition may occur at any time, particularly after acute (e.g. storm events) or prolonged (e.g. drought) environmental stresses or injuries (e.g. root severance). Routine surveys at different times of the year and within two - three years of each other (subject to the incidence of the above stresses) are recommended for the health and safety management of trees remote from highways or busy access routes. Annual surveys are recommended for the latter.
- 2.3.4 The survey does not cover the arrangements that may be required in connection with the laying or removal of underground services.

2.4 Survey Data & Report Layout

- 2.4.1 Detailed records of individual trees are given in the survey schedule in Appendix 1 to this report. General husbandry recommendations are provided at Appendix 2, if for whatever reason the development does not go ahead, our recommendations in Appendix 2 would still apply.
- 2.4.2 A site plan identifying the surveyed trees, based on the Instructing Party's drawings / topographical survey is provided in Part 3 of this report.
- 2.4.3 This plan also serves as the Tree Constraints Plan with the theoretical Recommended Protection Areas (RPA's), tree canopies and shade constraints, (from BS5837: 2012) overlain onto it. These constraints are then overlain in turn onto the Instructing Party's proposals to create a second Arboricultural Impact Assessment Plan in Part 3. General observations and discussion follow, below.

3.0 OBSERVATIONS

3.1 Site Description



Photograph 1: 9 St-Martins Almshouses, Bayham Street, London NW1 0BD

- 3.1.1 The property is part of the St-Martin's Almshouses, a group of two storey houses built in 1818 by Henry Hake Seward. No. 9 is the end of terrace property located at the far right of the St Martins Almhouse development when viewed from Bayham Street.
- 3.1.2 The site is relatively level throughout.
- 3.1.3 In terms of the British Geological Survey, the site overlies the London Clay Formation (see indicated location on Fig.1 plan extract below). The associated soils are generally, highly shrinkable clay; e.g. slowly permeable seasonally waterlogged fine loam over clay. Such highly plastic soils are prone to movement: subsidence and heave. The actual distribution of the soil series are not as clearly defined on the ground as on plan and there may be anomalies in the actual composition of clay, silt and sand content.
- 3.1.4 Clay soils are prone to compaction during development with damage to soil structure potentially having a serious impact on tree health. The design of foundations near problematic tree species will also need to take into consideration subsidence risk. Further advice from the relevant experts on the specific soil properties can be sought as necessary.

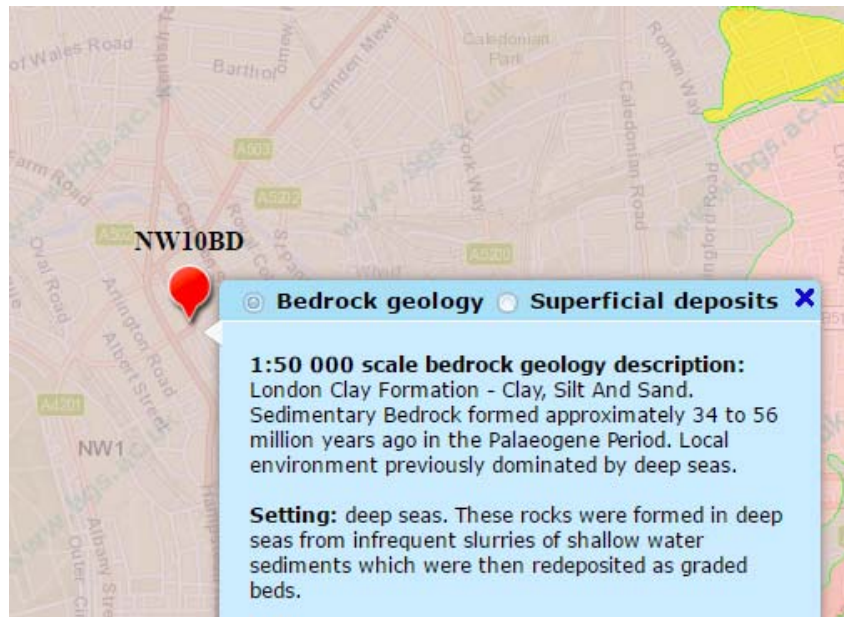

Figure 1: Extract from the BGS Geology of Britain Viewer

3.2 Subject Trees

3.2.1 4 trees were surveyed on and around the site, a semi-mature plum assessed as being U category *(Unsuitable for Retention), 2 mature London planes both assessed as being B category *(Moderate Quality) and a group of early mature common limes assessed as being B category *(Moderate Quality).

3.2.4 Full details of the surveyed trees can be found in Appendix 1 of this report.

3.3 Planning Status

3.3.1 We are not aware of the existence of any Tree Preservation Orders, but understand the site stands within a Conservation Area, which will affect the subject trees: it is a criminal offence to prune, damage or fell such trees without permission from the local authority.

3.3.2 Relevant local planning policies comprise Policy 7.21 of the London Plan 2015, Policies CS15, DP24 and DP25, and DP27 of the London Borough of Camden Local Development Framework Core Strategy.

4.0 DEVELOPMENT CONSTRAINTS

4.1 Primary Constraints

- 4.1.1 BS5837: 2012 gives Recommended Protection Areas (RPA's) for any given tree size. The individual RPA's are calculated in the Tree Schedule in Appendix 1 to this report, or rather the notional radius of that RPA, based on a circular protection zone. The prescribed radius is 12-x stem diameter at 1.5m above ground level, except where composite formulae are used in the case of multi-stemmed trees.
- 4.1.2 Circular RPA's are appropriate for individual specimen trees grown freely, but where there is ground disturbance, the morphology of the RPA can be modified to an alternative polygon, as shown in the diagram below (Figure 2). Alternatively, one need principally remember that RPA's are area-based and not linear – notional rather than fixed entities.

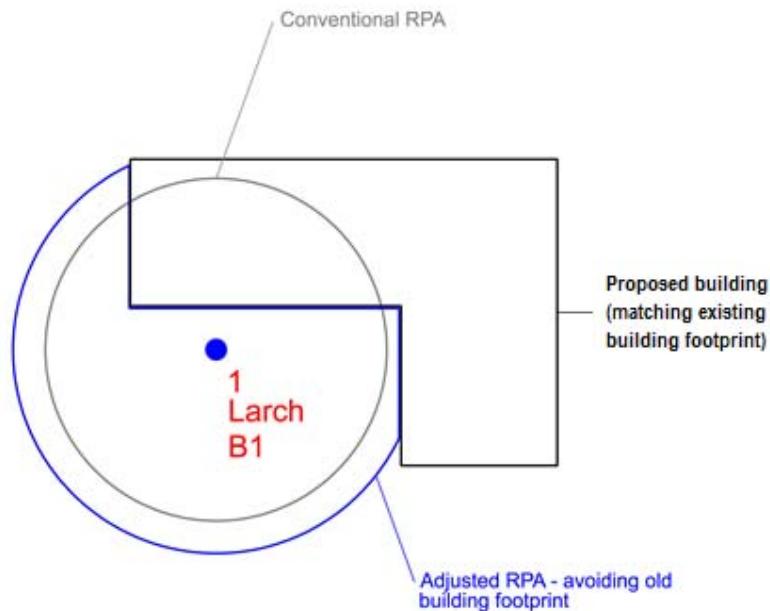

Figure 2 – Generic BS 5837 RPA Adjustments

- 4.1.3 In BS5837, paragraph 4.6.2 states that RPA's should reflect the morphology and disposition of the roots; where pre-existing site conditions or other factors indicate that rooting has occurred asymmetrically, a polygon of equivalent area should be produced. Modifications to the shape of the RPA should reflect a soundly based arboricultural assessment of likely root distribution.
- 4.1.4 No *a priori* modifications have been made in this instance, though further investigations are recommended, where the proposals encroach / come near RPA and their modification could have a bearing on the impact assessment.

4.1.5 The quality of trees will also be a consideration: U Category trees are discounted from the planning process in view of their limited service life. Again, Category-C trees would not normally constrain development individually, unless they provide some external screening function.

4.1.6 At paragraph 5.1.1. BS5837: 2012 notes that "Care should be exercised over misplaced tree preservation; attempts to retain too many or unsuitable trees on a site are liable to result in excessive pressure on the trees during demolition or construction work, or post-completion demands on their removal."

4.1.7 In theory, only moderate quality trees and above are significant material constraints on development. However, the low quality trees would comprise a constraint in aggregate, in terms of any collective loss / removal, where replacement planting would be appropriate, though no such collective impact is proposed.

4.1.8 In this instance, the only internal site tree is unsuitable for retention and therefore few significant primary constraints upon development, provided it will not be necessary to build right up to the boundaries.

4.2 Secondary Constraints

4.2.1 The second type of constraint produced by trees that are to be retained is that the proximity of the proposed development to the trees should not threaten their future with ever increasing demands for tree surgery or felling to remove nuisance shading (Figure 3), honeydew deposition or perceived risk of harm.

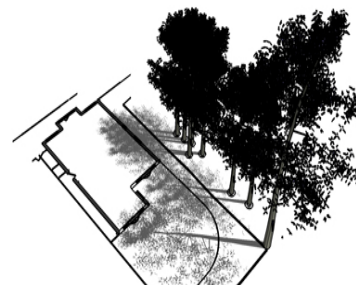

Figure 3 –
Generic Shading Constraints

4.2.2 The shading constraints are crudely determined from BS5837 by drawing an arc from northwest to east of the stem base at a distance equal to the height of the tree, as shown in the diagram opposite. Shade is less of a constraint on non-residential developments, particularly where rooms are only ever temporarily occupied.

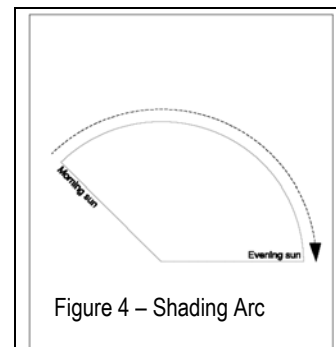

Figure 4 – Shading Arc

4.2.3 This arc (see Figure 4) represents the effects that a tree will have on layout through shade, based on shadow patterns of 1x tree height for a period May to Sept inclusive 10.00-18.00 hrs daily.

4.2.4 Assuming that they will be retained, the orientation of the on-site trees will ensure that shading constraints are minimal, with leaf deposition and honey-dew likely to be as it is today. However, the off-site trees have the potential to provide a variety of secondary constraints, including shading, organic deposition and the potential need to maintain crown clearance in the future. The significance of these constraints will vary depending on the location and proximity to the proposed re-development.

Note: Sections 5 & 6 will now assess the impacts upon constraints identified in Section 4. Table 1 in Section 5 presents the impacts in tabular form (drawing upon survey data presented in Appendices 1 & 2). Impacts are presented in terms of whole tree removal and the effect on the landscape or partial encroachment (% of RPA) and its effect on individual tree health. Section 6 discusses the table data, elaborating upon the impacts' significance and mitigation.

Table 1: Arboricultural Impact Assessment

(Impacts assessed prior to mitigation and rated with reference to Matheny & Clark (1998))

Ref: MXN/9STM/AIA

B.S. Cat.	Tree No.	Species	Impact	Tree / RPA Affected	Age	Growth Vitality	Species Tolerance	Impact on Tree Rating	Impact on Site Rating	Mitigation
B	2	Plane, London	Basement Construction within RPA Note: total impact is 20.4sqm of which 7.2sqm is existing basement	13.2 m ² 5.95 %	Mature	Normal	Good	Low	Low	Hand dig top 750mm of basement line thro' RPA
B	3	Plane, London	Replacement of Patio within RPA	m ² N/A %	Mature	Normal	Good	Very Low	Very Low	No-dig construction

6.0 DISCUSSION

6.1 Rating of Primary Impacts

- 6.1.1 The principal impact in the current proposals comprises the encroachment of the theoretical RPA of T2 by the rear extension, particularly the basement extension. The new basement footprint occupies 20.4sqm of the RPA of T2, of which 7.2sqm is part of the existing basement leaving a new encroachment of some 13.2sqm or 5.95% of the total area. The likely impact of this is assessed as being low, although the presence of the existing foul water drain along the route indicated on the sketch below may well have deflected the passage of roots along its course which will reduce the likely impact. The proposed mitigation of manual excavation of the top 750mm of the basement line with pre-emptive root pruning will further reduce this impact to very low levels
- 6.1.2 Provided the mitigation detailed in paragraph 6.3.1 is adopted, the demolition of the rear extension will be of very low impact to T2.
- 6.1.3 Any replacement and remodelling of the hard landscaping within the RPAs of T2 and T3 will require a no-dig construction methodology and utilise a permeable finished surface.

- 6.1.4 The principal of RPA encroachment is established within BS5837:2012 and supported by the source document, National Joint Utilities Guidelines 10 / Vol. 4 1995 / 2010. NJUG introduced the x12 diameter *Precautionary Zone* for supervised working and *Prohibited Zone* at a universal 1m from the base of the tree. RPA's are frequently confused with the NJUG Prohibited Zone, when they clearly correlate with the NJUG Precautionary Zone.
- 6.1.5 An RPA encroachment of <20% of RPA may be considered as low impact, given the permissive references to 20% RPA relocation and impermeable paving within BS5837:2012 and other published references to healthy trees tolerating up to 30-50% root severance (Coder, Helliwell and Watson in CEH 2006). The trees in question are healthy specimens of species with a good resistance to development impacts, and quite capable of tolerating these low impacts.
- 6.1.6 "In practice 50% of roots can sometimes be removed with little problem, provided there are vigorous roots elsewhere. Inevitably, this degree of root loss will temporarily slow canopy growth and even lead to some dieback" (Thomas 2000). LT do not recommend annexing such high proportions of the root system; rather that within the context of the published science, planning should not be unduly concerned by impacts that are well below the subcritical threshold – *tree health is not at stake*.

6.1.7 BS5837 recommends (at 5.3.a) that if operations within the RPA are proposed, the project arboriculturist should demonstrate that the tree(s) can remain viable and that the area lost to encroachment can be compensated for elsewhere, contiguous with its RPA. On the basis of Thomas et al, above, it is possible to demonstrate that the tree can remain viable, and on the basis that the tree will be rooting no less freely in the garden / lawn / border / pavement than within the proposed footprint, with the RPA encroachment compensated elsewhere on contiguous land. The guide also recommends (at 5.3.b) the arboriculturist propose a series of mitigation measures (to improve the soil environment that is used by the tree for growth). These are provided at 6.3 below.

6.2 Rating of Secondary Impacts

6.2.1 There will always be marginal secondary impacts of honeydew / litter deposition and partial shade on this site, regardless of development. The status quo is unlikely to change with further development, which is the salient point for planning to consider. Thus, the secondary impacts of development are minimal.

6.3 Mitigation of Impacts

6.3.1 All plant and vehicles engaged in demolition works should either operate outside the RPA, or should run on a temporary surface designed to protect the underlying soil structure. The demolition of the building should proceed inwards in a "pull down" fashion. Hard surfacing can be lifted with caution by a skilled machine operator again working away from the tree.

6.3.2 The path of foundations through RPAs will be manually excavated to 750mm depth under arboricultural supervision; any roots encountered within the trenches / pits will be cleanly pruned back to an appropriate junction with a sharp pruning saw or secateurs back to a junction. Roots larger than 25mm diameter may only be cut in consultation with an arboriculturalist.

6.3.3 The replacement paving/hard landscaping will require a no-dig construction technique, either using a cellular confinement system with no fines aggregate for the sub-base or simply building upon the existing sub-base without disturbing the ground below. Choice of construction method will initially depend upon root penetration within the existing sub-grade. The key principle is not to excavate in the presence of roots and to provide a porous surface to promote healthy soil water relations for future root growth. A further consideration in the use of a more expensive cellular confinement system or similar, may be the claimed reduction in risk of possible future slab / surface displacement by roots of trees growing in paved areas.

- 6.3.4 Nuisance deposition can be further mitigated with routine maintenance, light pruning / deadwooding and the fitting of filtration traps on guttering (see Figure 5 below).
- 6.3.5 The shading impacts can be mitigated by building design, with the provision of dual aspect windows and choice of room layout. Some minor crown reduction may be necessary, but not such as to impose a burden of frequent, repetitive management.

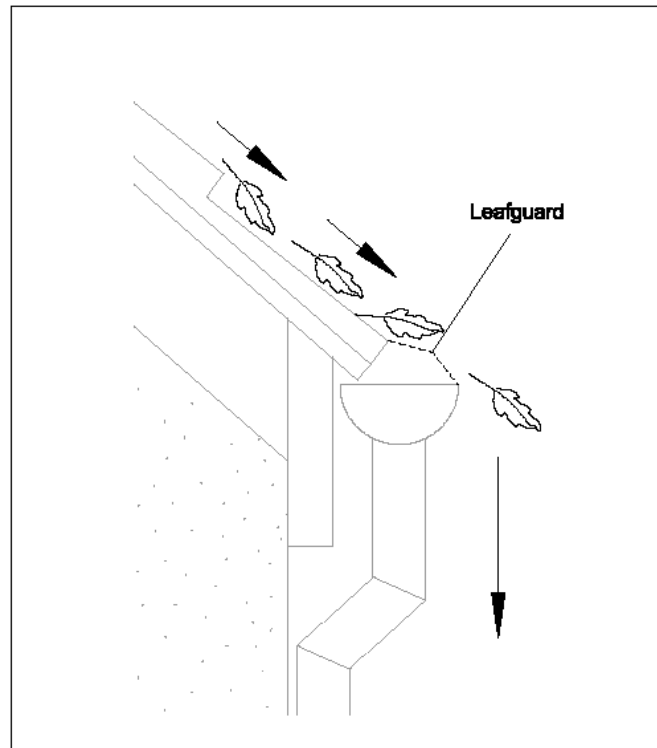

Figure 5: Filtration traps, as shown above, could be fitted on the gutters which can easily be maintained at 2-3m above ground.

7.0 CONCLUSION

- 7.1 The potential impacts of development are all relatively low in terms of both quality of trees removed and also RPA encroachments of trees retained.
- 7.2 The full potential of the impacts can be largely mitigated through design and precautionary measures. These measures can be elaborated in Method Statements in the discharge of planning conditions.
- 7.3 The species affected are generally tolerant of root disturbance / crown reduction and the retained trees are generally in good health and capable of sustaining these reduced impacts.
- 7.4 Therefore, the proposals will not have any significant impact on either the retained trees or wider landscape and thereby comply with Policy 7.21 of the London Plan 2015, Policies CS15, DP24 and DP25, and DP27 of the London Borough of Camden Local Development Framework Core Strategy. Thus, with suitable mitigation and supervision the scheme is recommended to planning.

8.0 RECOMMENDATIONS

8.1 Specific Recommendations

- 8.1.1 Tree works recommendations in Appendix 2 are not part of the current application, but requirements of general maintenance that will need to be applied for (subject to para. 3.3 of this report and any other relevant constraints in planning or leasehold) by the client separately. Consent for the current planning application does not impart any consent for the Appendix 2 maintenance works. Please note, though, the owner and / or manager of a property have a duty to maintain a safe site of work and to protect occupiers of the surrounding land / members of the public from tree hazards. Works recommended in this report should be enacted in a timely fashion by the relevant party regardless of the progress of the development.
- 8.1.2 Excavation and construction impacts within the RPA's of trees identified in Table 1 above, will need to be controlled by method statements specifying mitigation methods suggested in para 6.3 above and by consultant supervision as necessary. These method statements can be provided as part of the discharge of conditions.

8.2 General Recommendations for Sites Being Developed with Trees

- 8.2.1 Any trees which are in close proximity to the proposed development should be protected with a Tree Protection Barrier (TPB). Protective barrier fencing should be installed immediately following the completion of the tree works, remaining in situ for the entire duration of the development unless otherwise agreed in writing by the Council. It should be appropriate for the intensity and proximity of the development, usually comprising steel, mesh panels 2.4m in height ('Heras') and should be mounted on a scaffolding frame (shown in Fig 2 of BS5837:2012). The position of the TPB can be shown on plan as part of the discharge of conditions, once the layout is agreed with the planning authority. The TPB should be erected prior to commencement of works, remain in its original form on-site for the duration of works and be removed only upon full completion of works.
- 8.2.2 A TPB may no longer be required during soft landscaping work but a full arboricultural assessment must be performed prior to the undertaking of any excavations within the RPA of a tree. This will inform a decision about the requirement of protection measures. It is important that all TPBs have permanent, weatherproof notices denying access to the RPA.
- 8.2.3 The use of heavy plant machinery for building demolition, removal of imported materials and grading of surfaces should take place in one operation. The necessary machinery should be located above the existing grade level and work away from any retained trees. This will ensure that any spoil is removed from the RPAs. It is vital that the original soil level is not lowered as this is likely to cause damage to the shallow root systems.

- 8.2.4 Any pruning works must be in accordance with British Standard 3998:2010 Tree work [BS3998].
- 8.2.5 Where sections of hard surfacing are proposed in close proximity to trees, it is recommended that “No-Dig” surfacing be employed in accordance with BS5837:2012 and ‘The Principles of Arboricultural Practice: Note 1, Driveways Close to Trees, AAIS 1996 [APN1]’.
- 8.2.6 If the RPA of a tree is encroached by underground service routes then BS5837:2012 and NJUG VOLUME 4 provisions should be employed. If it is deemed necessary, further arboricultural advice must be sought.
- 8.2.7 Numerous site activities are potentially damaging to trees e.g. parking, material storage, the use of plant machinery and all other sources of soil compaction. In operating plant, particular care is required to ensure that the operational arcs of excavation and lifting machinery, including their loads, do not physically damage trees when in use.
- 8.2.8 To enable the successful integration of the proposal with the retained trees, the following points will need to be taken into account:
- 1) Plan of underground services.
 - 2) Schedule of tree protection measures, including the management of harmful substances.
 - 3) Method statements for constructional variations regarding tree proximity (e.g. foundations, surfacing and scaffolding).
 - 4) Site logistics plan to include storage, plant parking/stationing and materials handling.
 - 5) Tree works: felling, required pruning and new planting. All works must be carried out by a competent arborist in accordance with BS3998.
 - 6) Site supervision: the Site Agent must be nominated to be responsible for all arboricultural matters on site. This person must:
 - be present on site for the majority of the time;
 - be aware of the arboricultural responsibilities;
 - have the authority to stop work that is causing, or may cause harm to any tree;
 - ensure all site operatives are aware of their responsibilities to the trees on site and the consequences of a failure to observe these responsibilities;
 - make immediate contact with the local authority and/or a retained arboriculturalist in the event of any tree related problems occurring.
- 8.2.9 These points can be resolved and approved through consultation with the planning authority via their Arboricultural Officer.

8.2.10 The sequence of works should be as follows:

- i) initial tree works: felling, stump grinding and pruning for working clearances;
- ii) installation of TPB for demolition & construction;
- iii) installation of underground services;
- iv) installation of ground protection;
- v) main construction;
- vi) removal of TPB;
- vii) soft landscaping.

9.0 REFERENCES

- Barlow JF & Harrison G. 1999. Shade By Trees, Arboricultural Practice Note 5, AAIS, Farnham, Surrey.
- British Standards Institute. 2012. Trees in Relation to Design, Demolition and Construction - Recommendations BS 5837: 2012 HMSO, London.
- Centre for Ecology & Hydrology. 2006. Tree Roots in the Built Environment, HMSO, London.
- Helliwell R (1980) Provision for New Trees; Landscape Design; July/August issue
- International Society of Arboriculture (ISA). 1994. The Landscape Below Ground. ISA, Champaign, Illinois. USA.
- Lonsdale D 1999. Research for Amenity Trees No.7: Principles of Tree Hazard Assessment and Management, HMSO, London.
- Matheny, N; Clark, J. R.1998. Trees and Development: A Technical Guide to Preservation of Trees during Land Development. ISA, Champaign, Illinois. USA.
- Mattheck C. & Breloer H. 1994. Research for Amenity Trees No.2: The Body Language of Trees, HMSO, London.
- Thomas P, 2000. Trees: Their Natural History, Cambridge University Press, Cambridge.
- Trowbridge J & Bassuk N (2004) Trees in the Urban Landscape: Site Assessment, Design, and Installation; J Wiley & Sons inc. NJ USA



PART 2 – APPENDICES

APPENDIX 1

TREE SCHEDULE

Botanical Tree Names

Lime, Common	: Tilia x europea	Plum spp	: Prunus spp
Plane, London	: Platanus acerifolia		

Notes for Guidance:

1. Height describes the approximate height of the tree measured in metres from ground level.
2. The Crown Spread refers to the crown radius in meters from the stem centre and is expressed as an average of NSEW aspect if symmetrical.
3. Ground Clearance is the height in metres of crown clearance above adjacent ground level.
4. Stem Diameter (Dm) is the diameter of the stem measured in millimetres at 1.5m from ground level for single stemmed trees. BS 5837:2012 formula (Section 4.6) used to calculate diameter of multi-stemmed trees. Stem Diameter may be estimated where access is restricted and denoted by '#'.
5. Protection Multiplier is 12 and is the number used to calculate the tree's protection radius and area
6. Protection Radius is a radial distance measured from the trunk centre.
7. Growth Vitality - Normal growth, Moderate (below normal), Poor (sparse/weak), Dead (dead or dying tree).
8. Structural Condition - Good (no or only minor defects), Fair (remediable defects), Poor - Major defects present.
9. Landscape Contribution - High (prominent landscape feature), Medium (visible in landscape), Low (secluded/among other trees).
10. B.S. Cat refers to (British Standard 5837:2012 section 4.5) and refers to tree/group quality and value; 'A' – High, 'B' - Moderate, 'C' - Low, 'U' - Unsuitable for retention. The following colouring has been used on the site plans:
 - High Quality (A) (Green),
 - Moderate Quality (B) (Blue),
 - Low Quality (C) (Grey),
 - Unsuitable for Retention (U) (Red)
11. Sub Cat refers to the retention criteria values where 1 is Arboricultural, 2 is Landscape and 3 is Cultural including Conservational, Historic and Commemorative.
12. Useful Life is the tree's estimated remaining contribution in years.



Site: 9 St Martins

Date: 04/04/2017

Appendix 1

Landmark Trees Ltd

020 7851 4544

Surveyor(s): Adam Hollis

Ref: MXN/9STM/AIA

BS5837 Tree Constraints Survey Schedule

Tree No.	English Name	Height	Crown Spread	Ground Clearance	Stem Diamete	Age Class	Protection Radius	Growth Vitality	Structural Condition	B.S. Cat	Sub Cat	Useful Life	Comments
1	Plum	4	5015	2.5	150	Semi-mature	1.8	Moderate	Fair	U		<10	Honey fungus on wounded base, A somewhat sparser than Leaning significantly NW
2	Plane, London	15	4544	3.0	700	Mature	8.4	Normal	Fair	B	2	40+	Pollarded Damaging third party drive and wall
3	Plane, London	14	3343	3.0	540	Mature	6.5	Normal	Fair	B	2	40+	Pollarded Damaging drive
G4	Lime, Common	5	1	3.0	350	Early Mature	4.2	Normal	Fair	B	2	40+	Pleached screen

APPENDIX 2

RECOMMENDED TREE WORKS

Notes for Guidance:

Husbandry 1 - Urgent (ASAP), 2 - Standard (within 6 months), 3 - Non-urgent (2-3 years)

- CB - Cut Back to boundary/clear from structure.
- CL# - Crown Lift to given height in meters.
- CT#% - Crown Thinning by identified %.
- CCL - Crown Clean (remove deadwood/crossing and hazardous branches and stubs)*.
- CR#% - Crown Reduce by given maximum % (of outermost branch & twig length)
- DWD - Remove deadwood.
- Fell - Fell to ground level.
- FInv - Further Investigation (generally with decay detection equipment).
- Pol - Pollard or re-pollard.
- Mon - Check / monitor progress of defect(s) at next consultant inspection which should be <18 months in frequented areas and <3 years in areas of more occasional use. Where the Owner/Instructing Party retain their own ground staff, we recommend an annual in- house inspection and where practical, in the aftermath of extreme weather events.
- Svr Ivy /
- Clr Bs - Sever ivy / clear base and re-inspect base / stem for concealed defects.

*Not generally specified following BS3998:2010

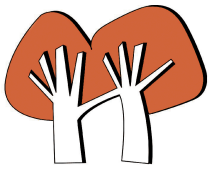

Site: 9 St Martins

Date: 04/04/2017

Surveyor(s): Adam Hollis

Ref: MXN/9STM/AIA

Appendix 2

Recommended Tree Works

[Hide irrelevant](#)
[Show All Trees](#)

Landmark Trees

Tree No.	English Name	B.S. Cat	Height	Ground Clearance	Crown Spread	Recommended Works	Comments/ Reasons
1	Plum	U	4	2.5	5015	Fell	Honey fungus on wounded base, A somewhat sparser than Leaning significantly NW Recommended husbandry 3



PART 3 – PLANS

PLAN 1

TREE CONSTRAINTS PLAN

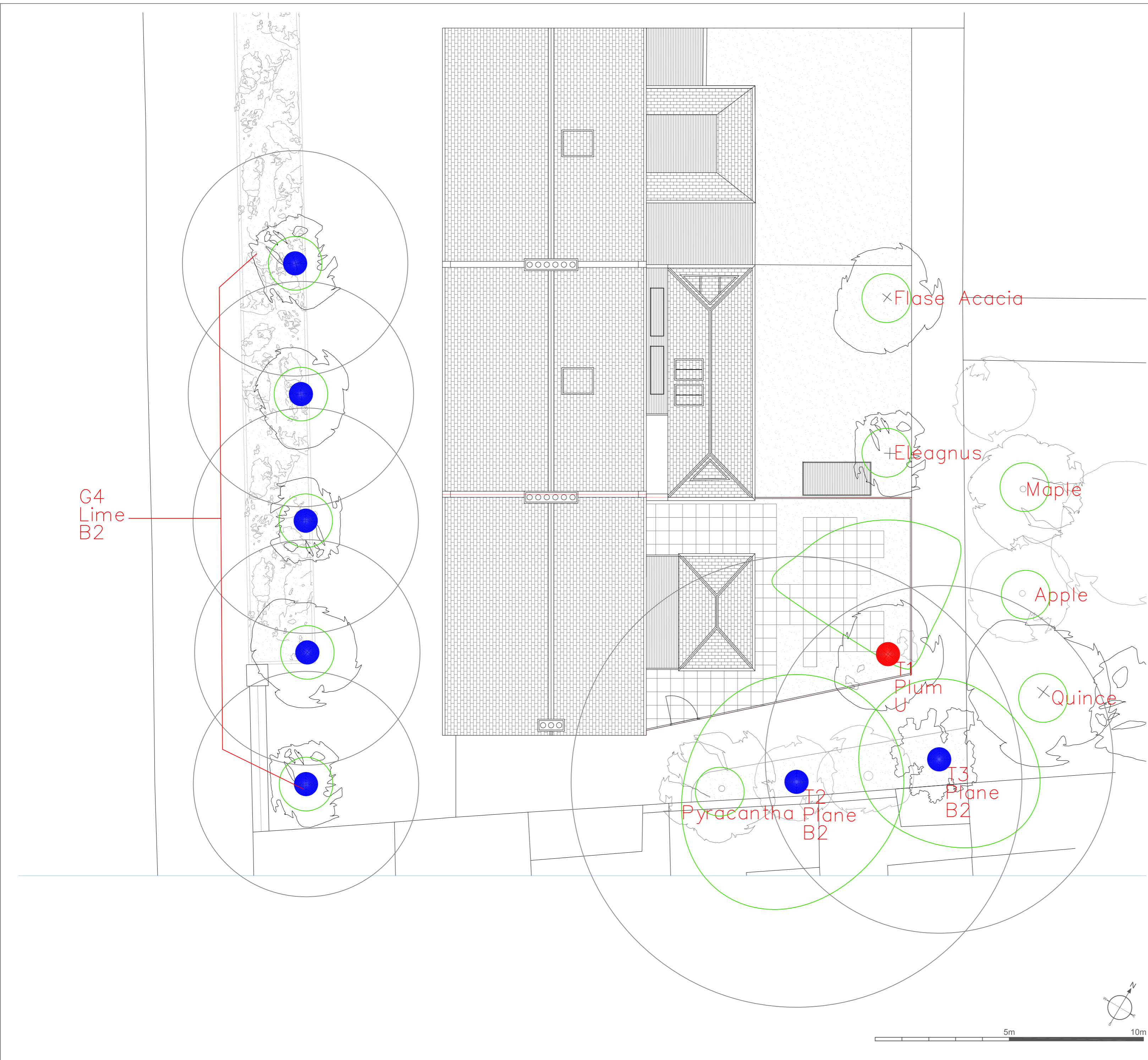

NOTE:
 This survey is of a preliminary nature. The trees were inspected from the ground only on the basis of the Visual Tree Assessment method. No samples were taken for analysis. No decay detection equipment was employed. The survey does not cover the arrangements that may be required in connection with the laying or removal of underground services.
 Branch spread in metres is taken at the four cardinal points to derive an accurate representation of the crown.
 Root Protection Areas (RPA) are derived from stem diameter measured at 1.5 m above adjacent ground level (taken on sloping ground on the upslope side of the tree base).

Landmark Trees
 20 Broadwick Street, London, W1F 8HT
 Tel: 0207 851 4544 Mobile: 07812 989928
 e-mail: info@landmarktrees.co.uk Web: www.landmarktrees.co.uk

Site: 9 St Martins 1:100@ A2
 Drawing Title: Tree Constraints Plan April 2017

Key:

- Category A High Quality
- Category B Moderate Quality
- Category C Low Quality
- Category U Trees Unsuitable for Retention

Category — Crown Spread
 Root Protection Area — Tree Number
 — Species
 — Category

Tree Position Approximate (not shown on original survey)

PLAN 2

ARBORICULTURAL IMPACT ASSESSMENT PLAN (S)

- i. Ground Floor

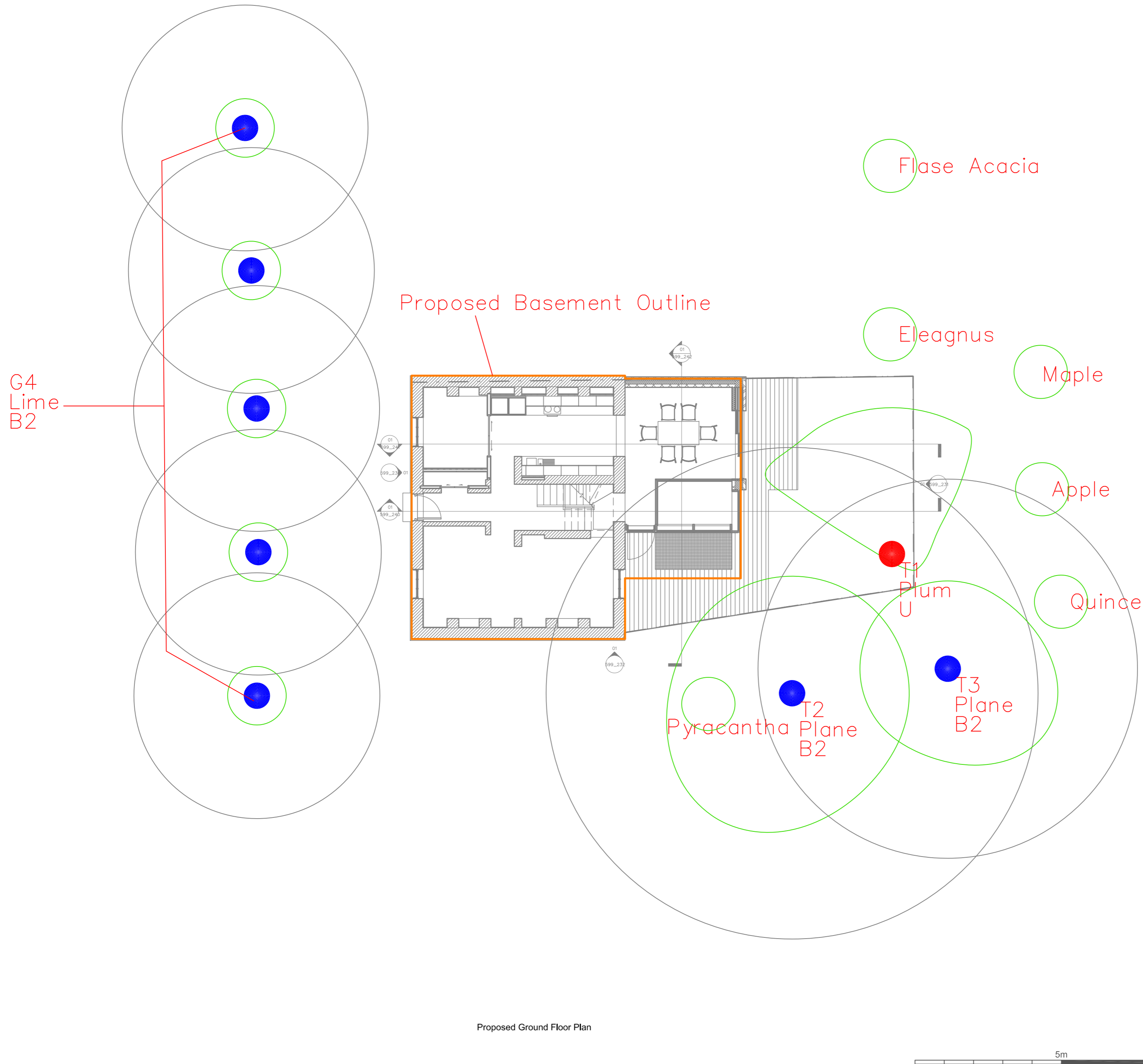

NOTE:
 This survey is of a preliminary nature. The trees were inspected from the ground only on the basis of the Visual Tree Assessment method. No samples were taken for analysis. No decay detection equipment was employed. The survey does not cover the arrangements that may be required in connection with the laying or removal of underground services.
 Branch spread in metres is taken at the four cardinal points to derive an accurate representation of the crown.
 Root Protection Areas (RPA) are derived from stem diameter measured at 1.5 m above adjacent ground level (taken on sloping ground on the upslope side of the tree base).

Landmark Trees
 20 Broadwick Street, London, W1F 8HT
 Tel: 0207 851 4544 Mobile: 07812 989928
 e-mail: info@landmarktrees.co.uk Web: www.landmarktrees.co.uk

Site: 9 St Martins 1:100@ A2

Drawing Title: Arboricultural Impact Assessment Plan April 2017

Key:

- Category A High Quality
- Category B Moderate Quality
- Category C Low Quality
- Category U Trees Unsuitable for Retention

Category — Crown Spread
 Root Protection Area — Tree Number
 — Species
 — Category
 ● Tree Position Approximate (not shown on original survey)