

Window A  
Quantity - 2

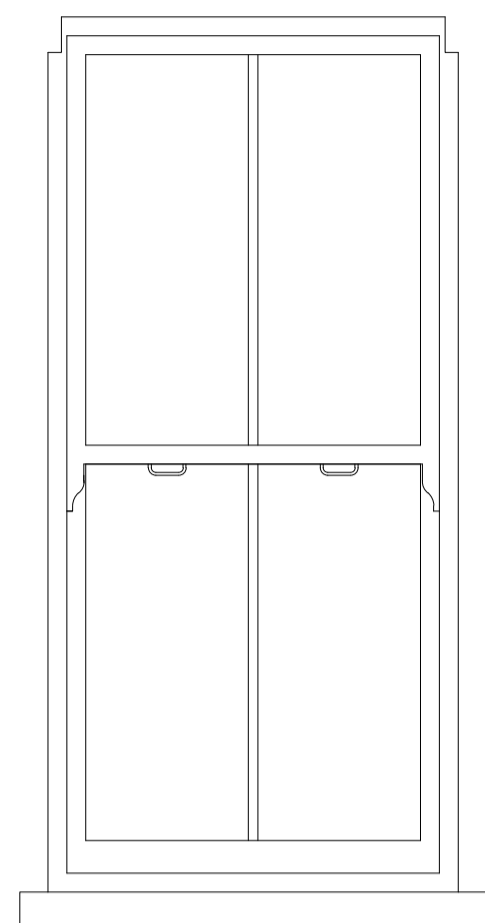

Window B  
Quantity - 2

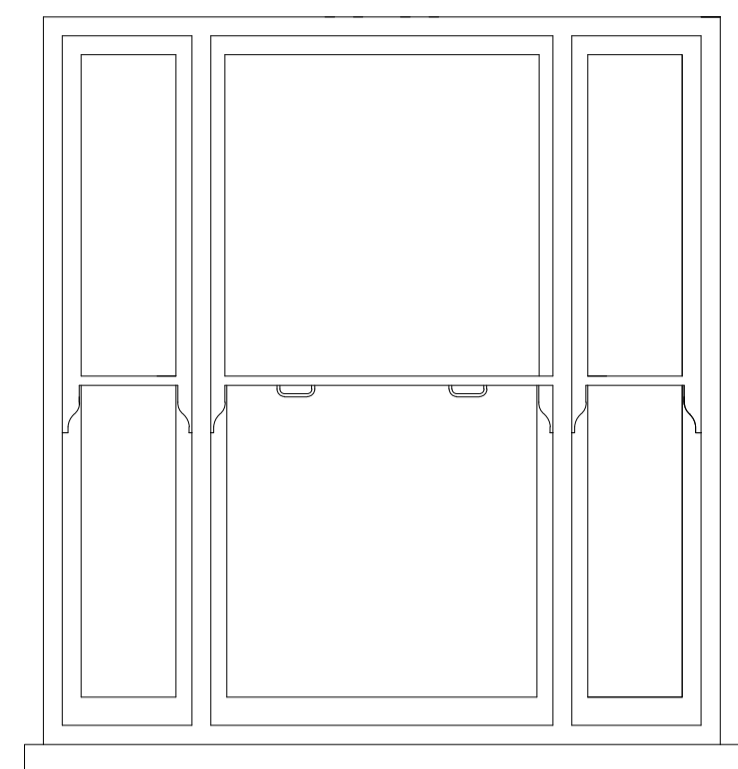

Window C  
Quantity - 1

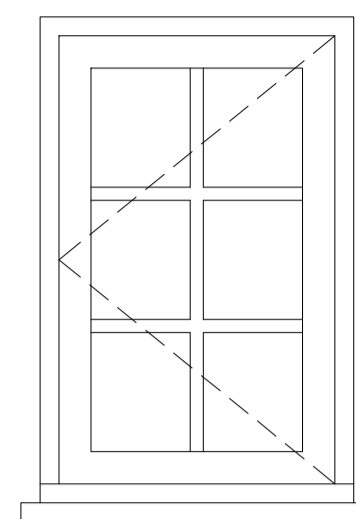

Window D  
Quantity - 1

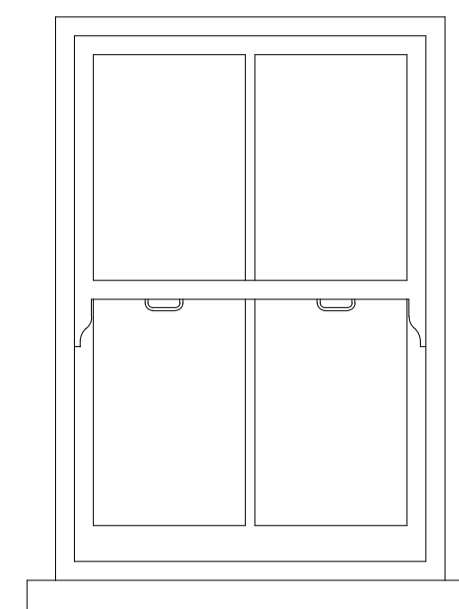

Window E  
Quantity - 1

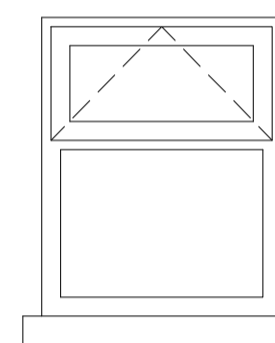

Window F  
Quantity - 1

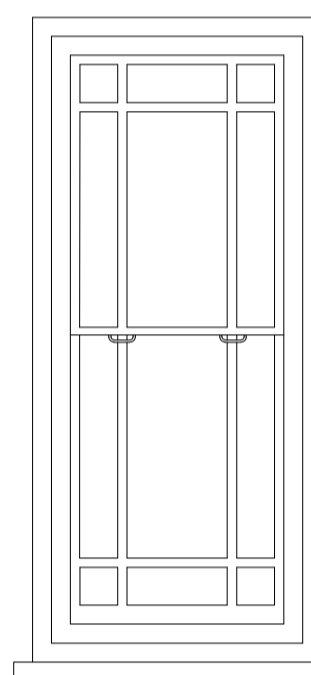

Window G  
Quantity - 1

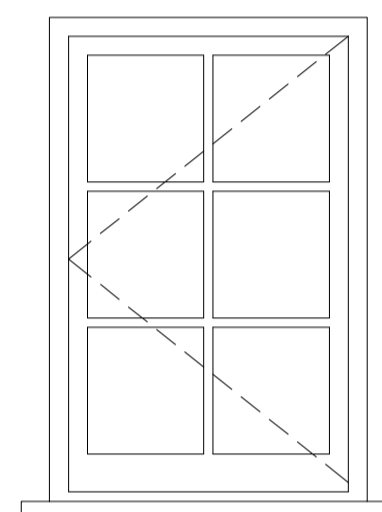

Window H  
Quantity - 1

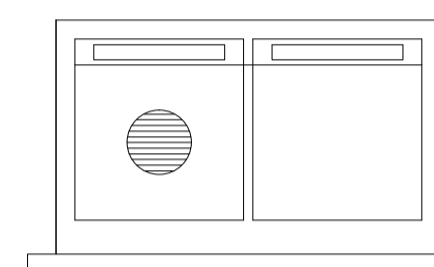

Window I  
Quantity - 1

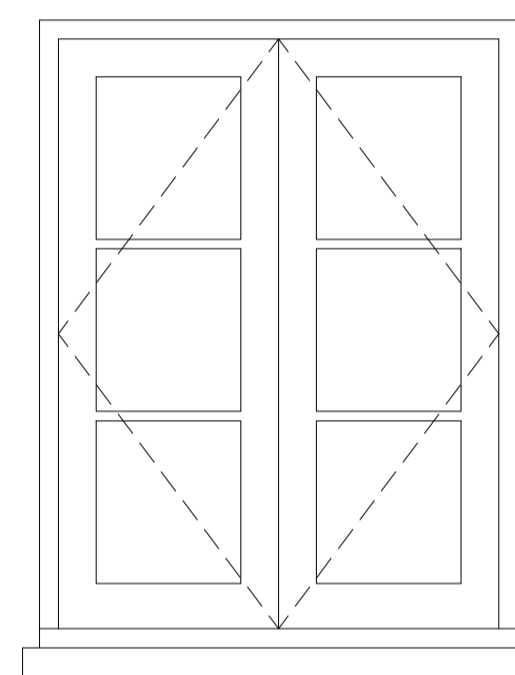

Window J  
Quantity - 1

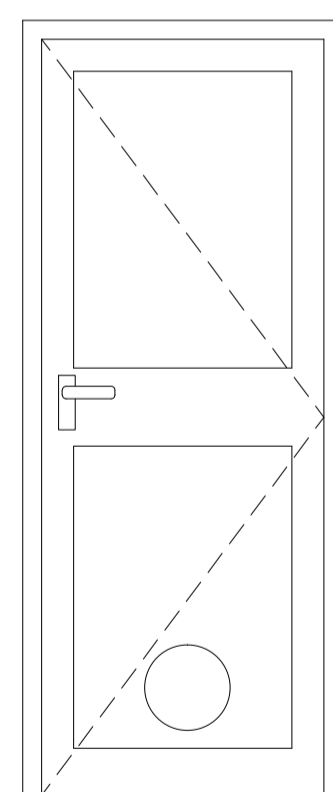

Door A  
Quantity - 1

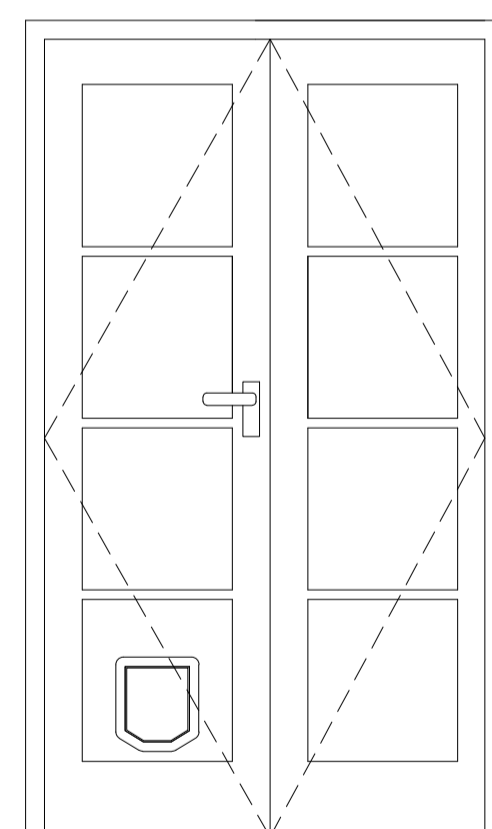

Door B  
Quantity - 1



Arcus Consulting LLP  
 Leeds 0113 218 5350 Manchester 0161 905 3222 Sheffield 0114 227 0096  
 Liverpool 0151 708 1080 Newcastle 0191 272 5781 info@arcus.uk.com  
[www.arcus.uk.com](http://www.arcus.uk.com)

Client  
 Origin Housing Ltd

Project  
 Stevenage Window Replacements 2017  
 177 Malden Road, Belsize Park, London. NW5 4HT

Title  
 Window and Door Schedule

Scale	Date	Stage
1:20@A1	07.07.2017	Planning
Job No	Drawing No	Rev
4655	953	-
Drawn	Approved	
AG	JH	

This drawing is the copyright of Arcus and the information is only to be used for planning purposes. All dimensions, quantities, opening configurations and trickle vent locations are illustrative & it is the contractor's responsibility to carry out a detailed survey prior to manufacture of windows and doors.

# 177 Malden Road - Window and Door Schedule - 1:20@A1