

DR-01

SCALE 1:20

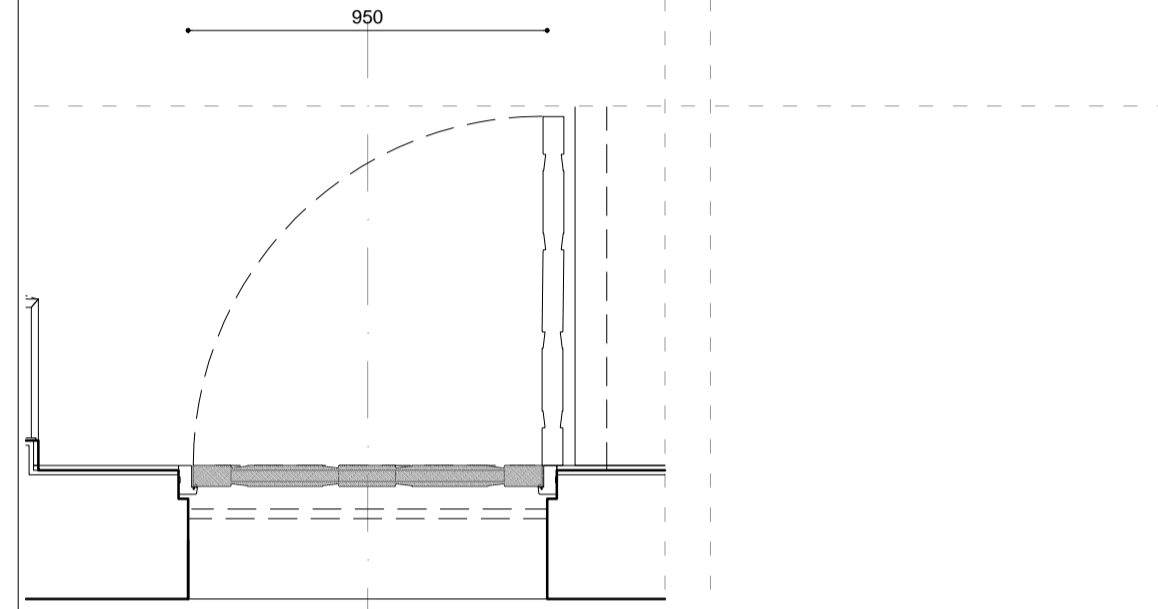

DESCRIPTION - NEW FRONT DOOR TO MATCH NEIGHBOURHOOD

- 1- DOOR LEAF: LAMINESSE FIRE SMOKE SPRUCE LAMINATE CORE FACED WITH MDF BS476 part22 FD30
- 2- FRAME: SOLID TIMBER
- 3- ARCHITRAVE: SOLID TIMBER
- 4- FINISH: TBS
- 5- HINGES: TBS
- 6- SEALS: TBS
- 7- FIRE REG: INTUMESCED STRIP AND SMOKE SEAL ALL AROUND THE PERIMETER
- 8- HANDLE: TBS
- 9- LOCK: BS

FIRE RATING 30 MINUTES

FRAME DETAILS SCALE 1:5

SECTION DETAILS

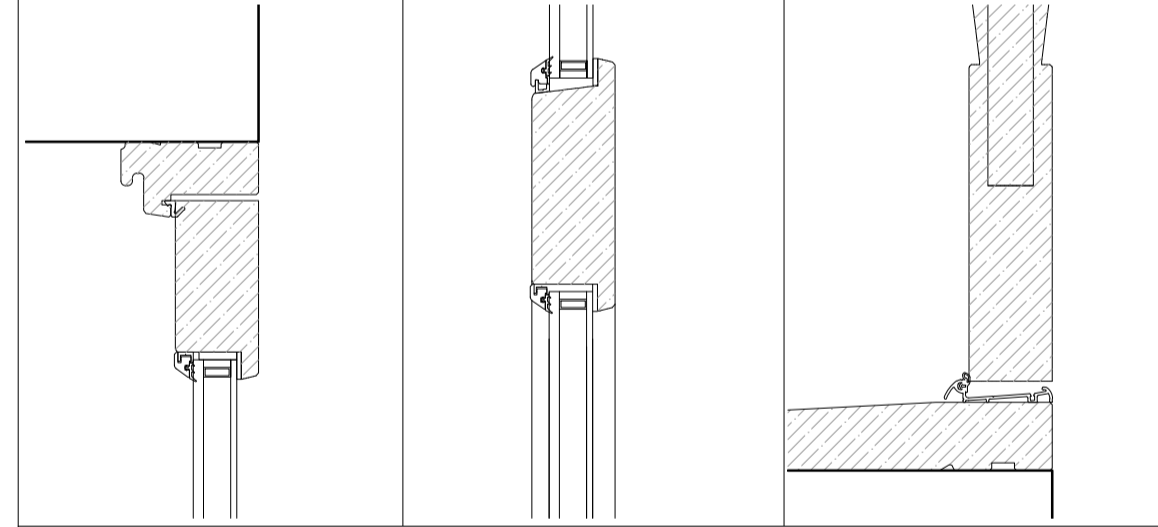

PLAN SECTION PLAN SECTION

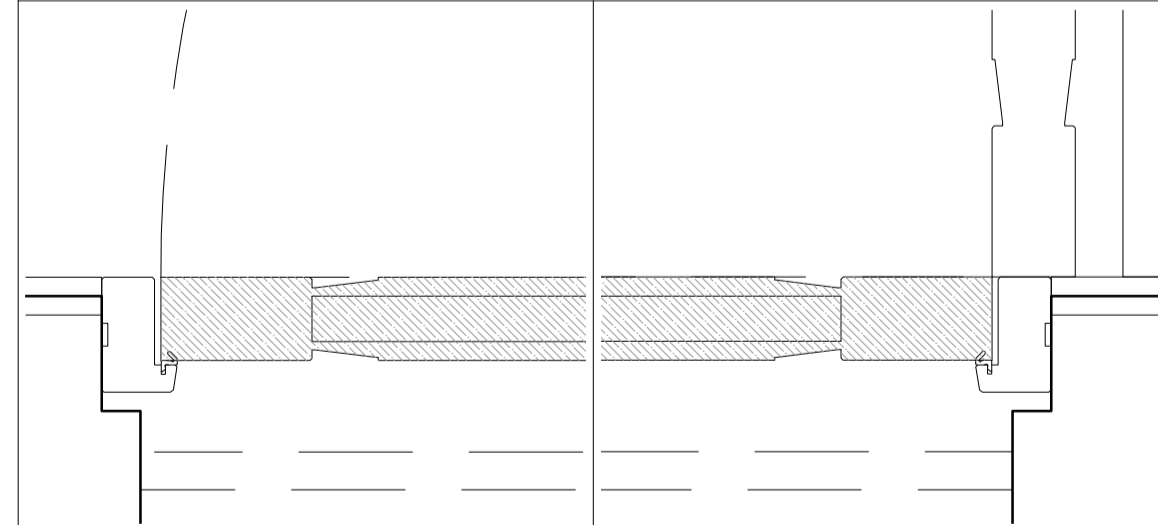

SUPPLY BY CUSTOM MADE

DR-02

SCALE 1:20

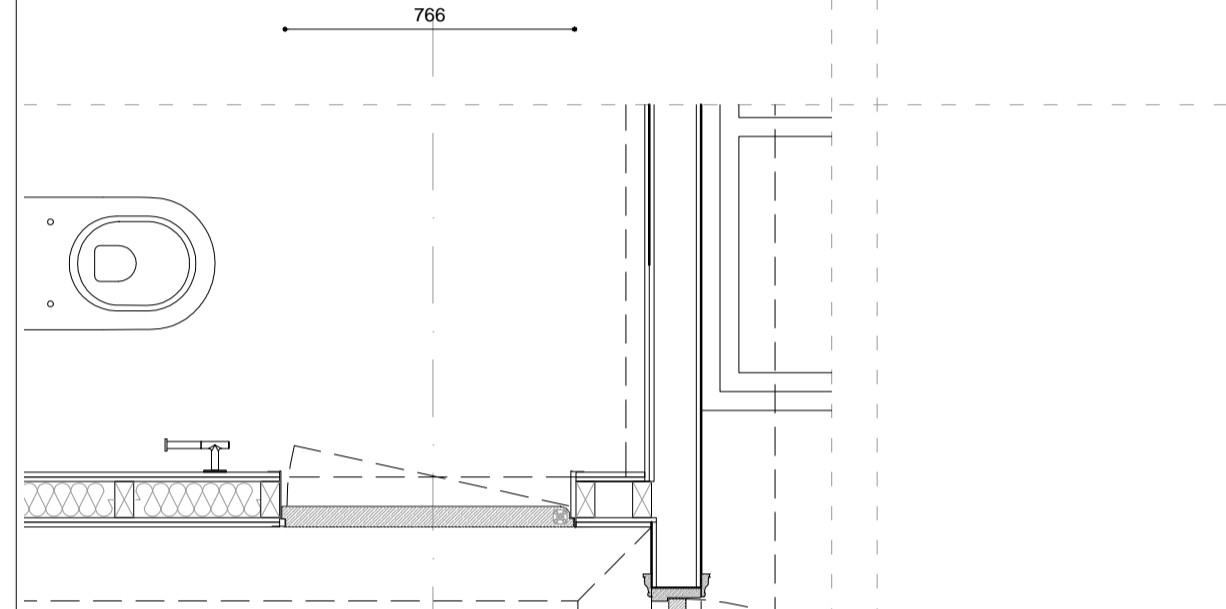
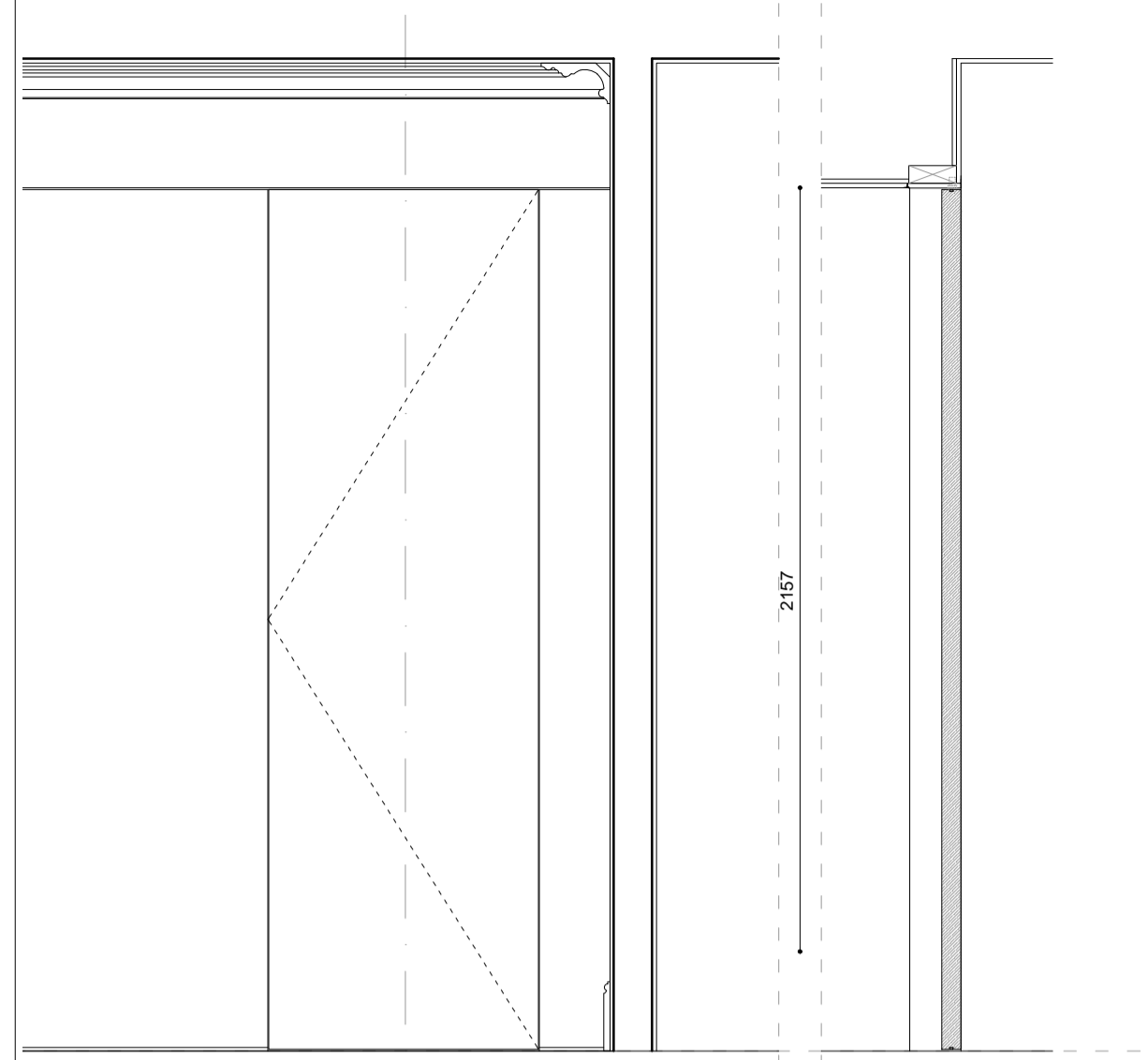

DESCRIPTION - SELQ_INNOVA PIVOT HINGED DOOR

- 1- DOOR LEAF: SEE INNOVA SPECIFICATIONS
- 2- FRAME: SEE INNOVA SPECIFICATIONS
- 3- ARCHITRAVE: SEE INNOVA SPECIFICATIONS
- 4- FINISH: HAND PAINTED FINISH
- 5- HINGES: SEE INNOVA SPECIFICATIONS
- 6- FIRE REG: -
- 7- HANDLE: TBC
- 8- LOCK: TBC

FIRE RATING NO

FRAME DETAILS SCALE 1:5

SECTION DETAILS

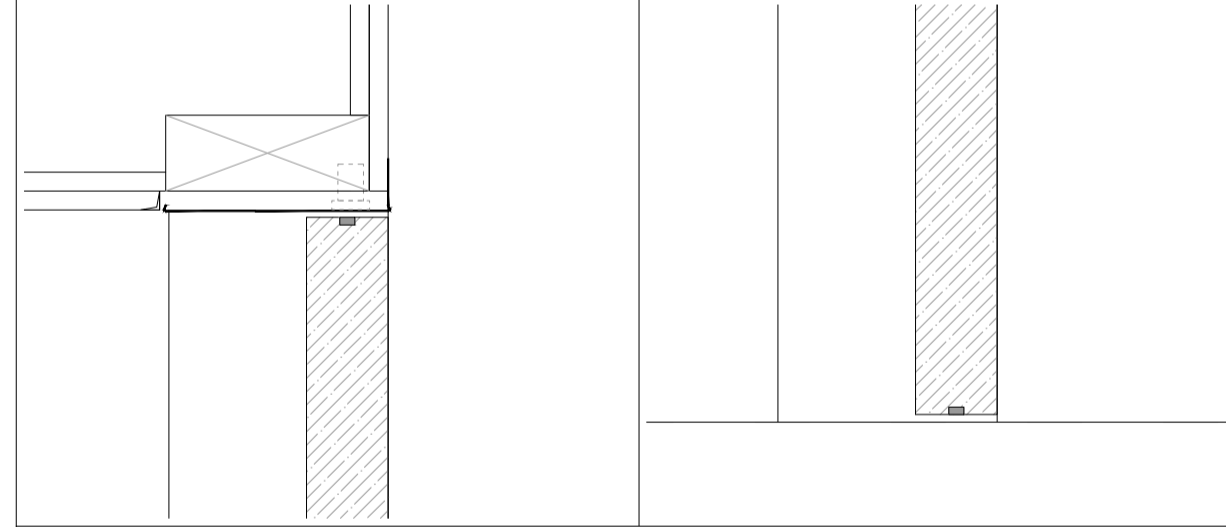

PLAN SECTION

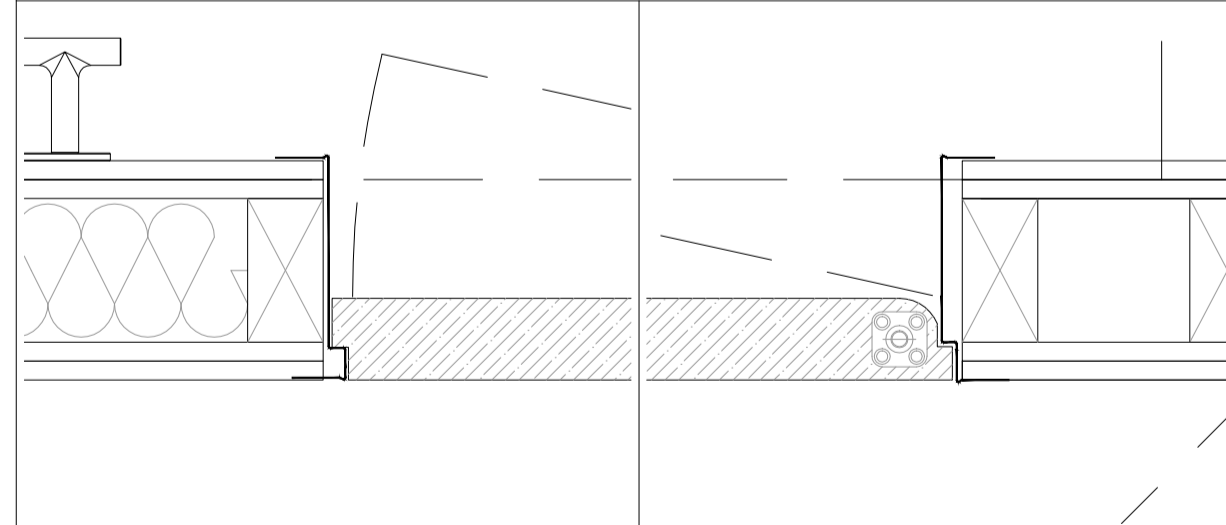

SUPPLY BY SELQ

DR-03

SCALE 1:20

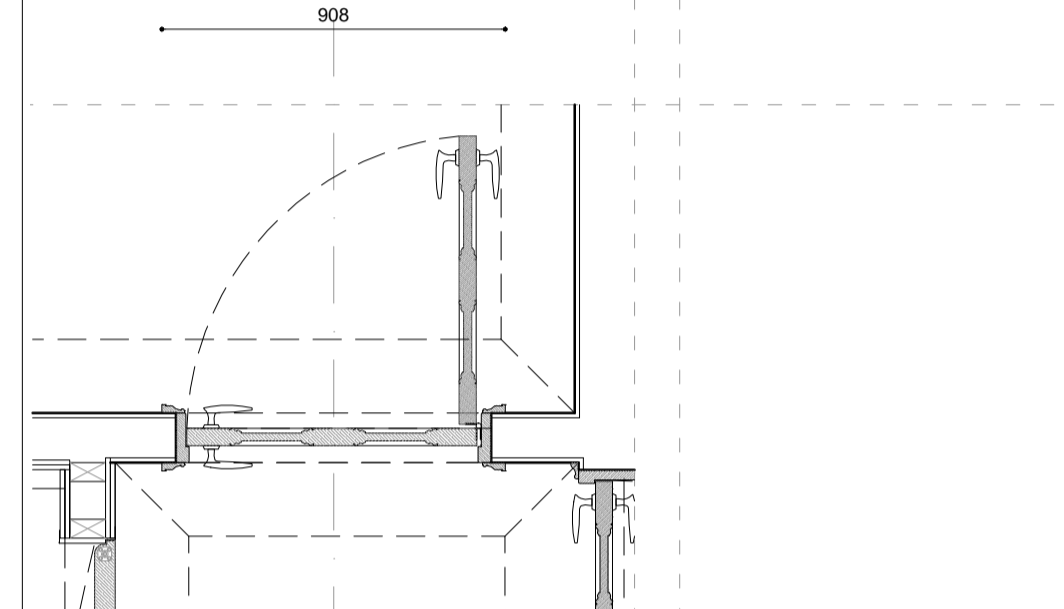
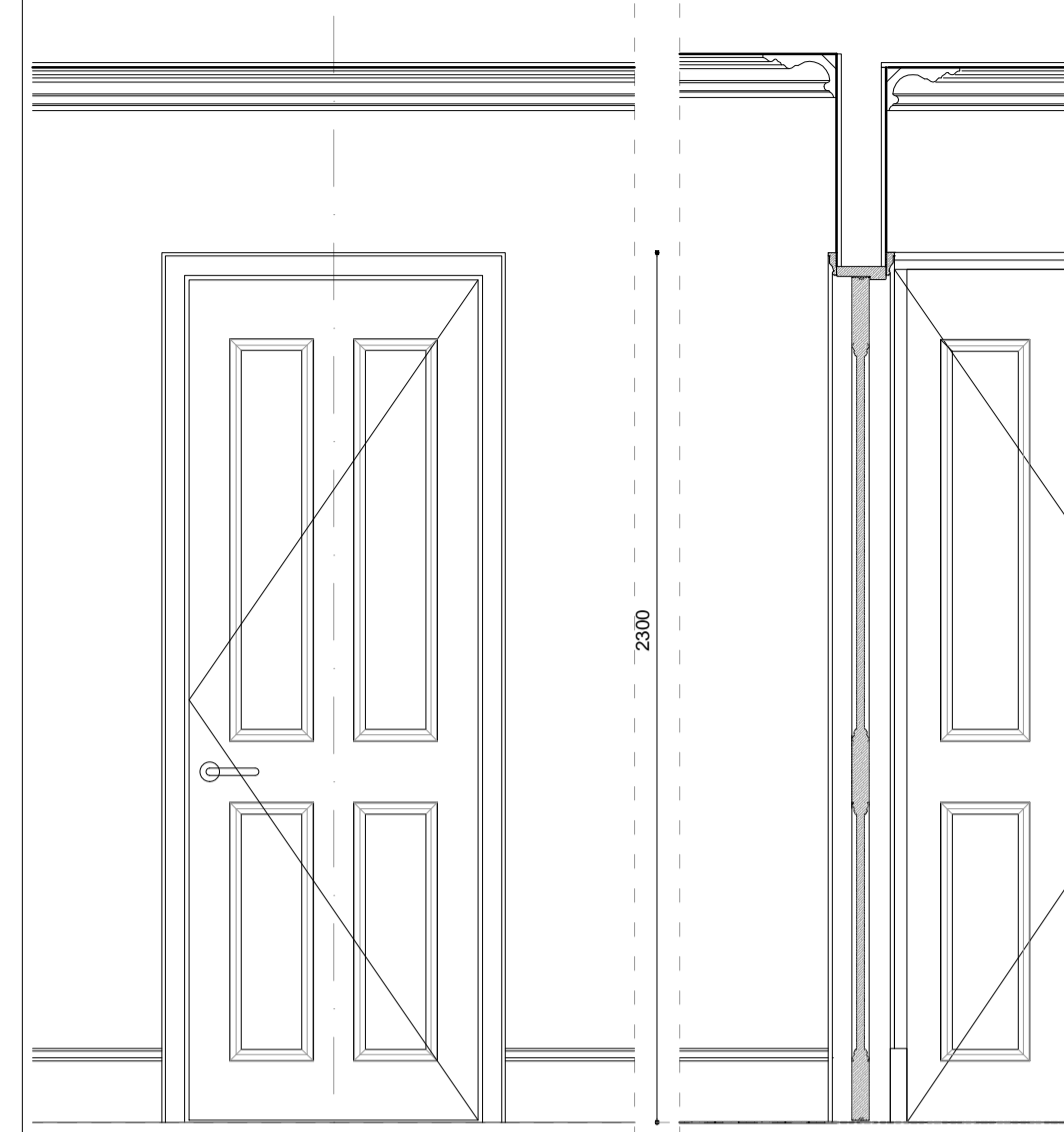

DESCRIPTION

- 1- DOOR LEAF: LAMINESSE FIRE SMOKE SPRUCE LAMINATE CORE FACED WITH MDF BS476 part22 FD30
- 2- FRAME: TIMBER
- 3- ARCHITRAVE: TIMBER
- 4- FINISH: HAND PAINTED
- 5- HINGES: TBS
- 6- FIRE REG: -
- 7- HANDLE: TBC
- 8- LOCK: TBC

FIRE RATING 30 MINUTES

FRAME DETAILS SCALE 1:5

SECTION DETAILS

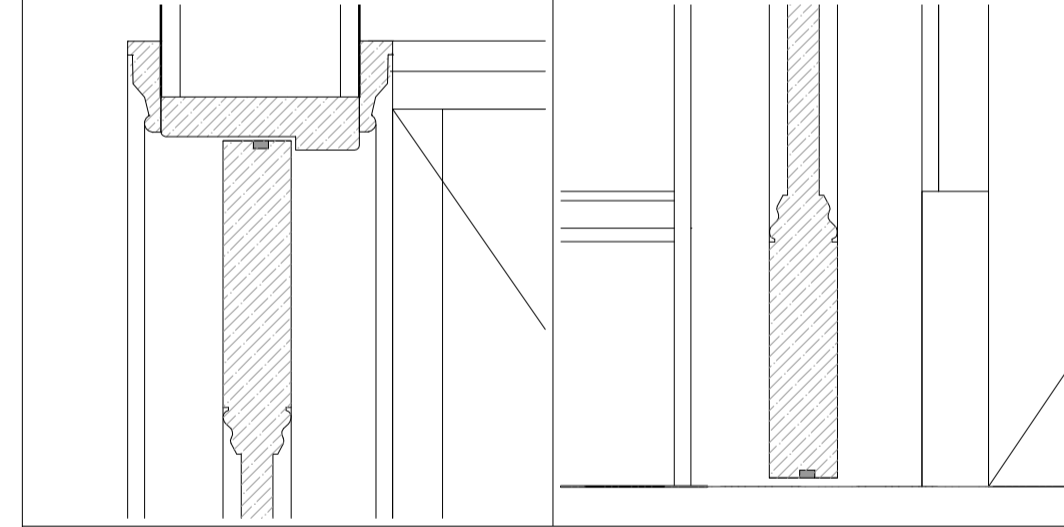

PLAN SECTION

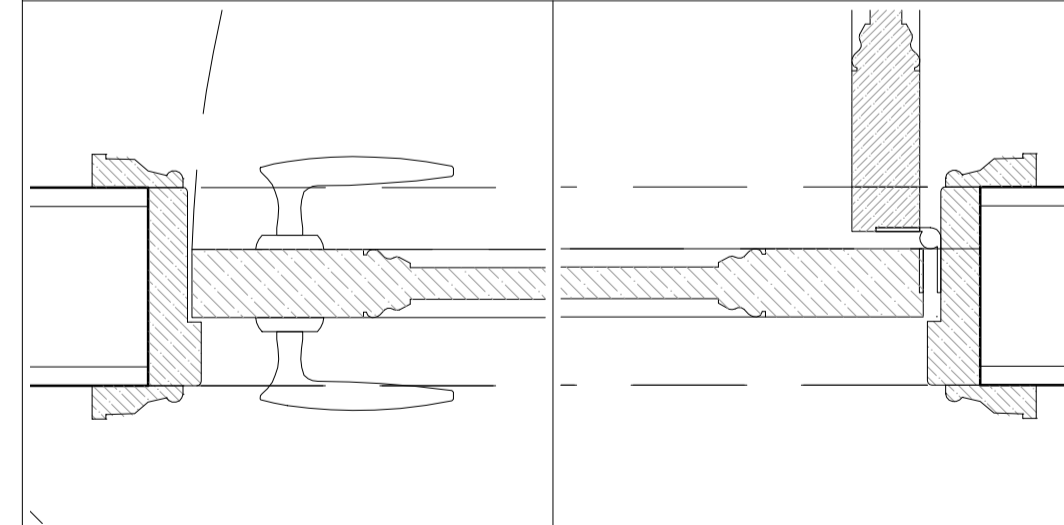

SUPPLY BY CUSTOM MADE

DR-04

SCALE 1:20

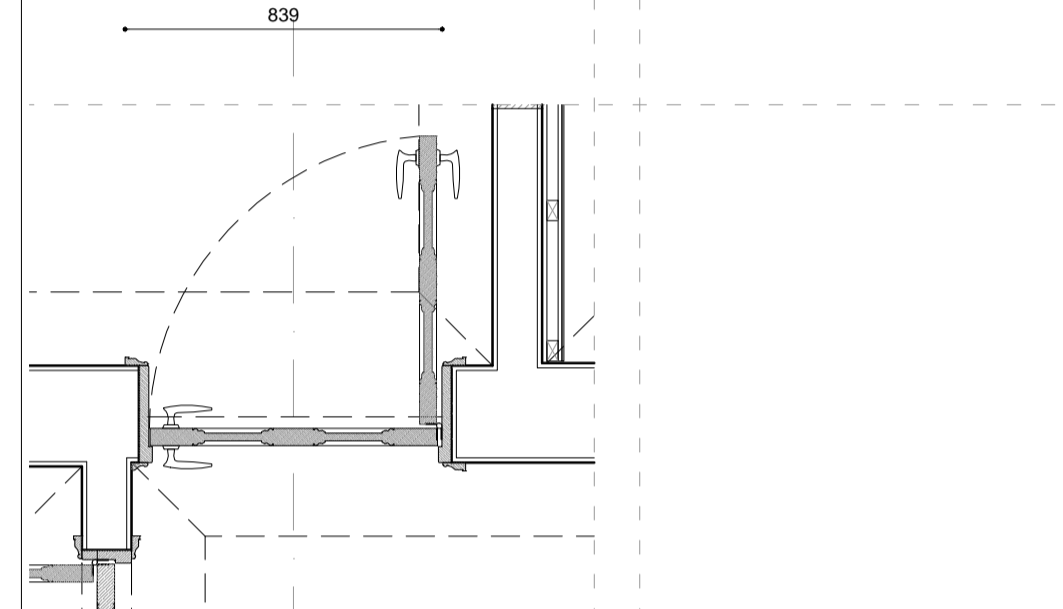
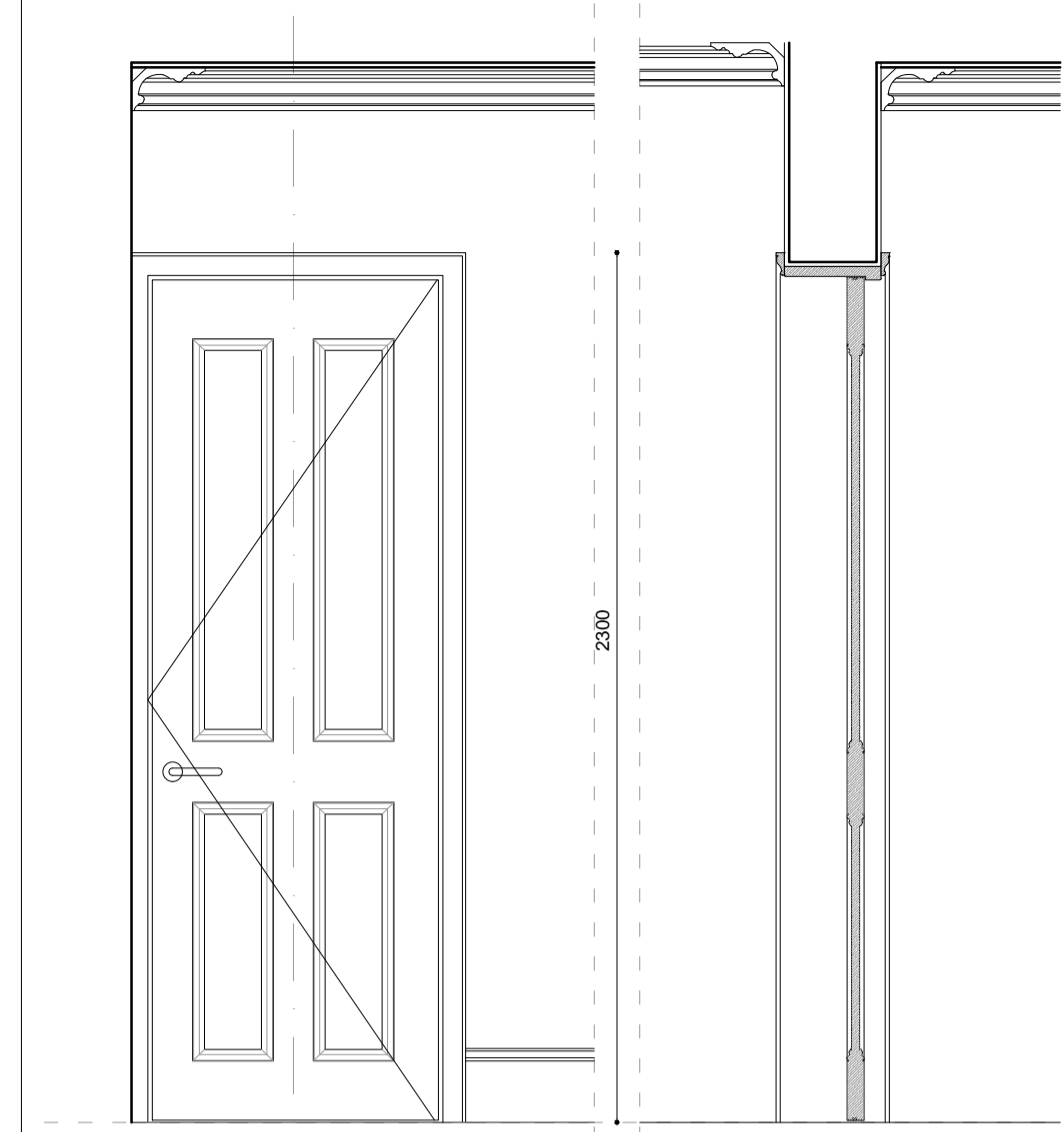

DESCRIPTION

- 1- DOOR LEAF: LAMINESSE FIRE SMOKE SPRUCE LAMINATE CORE FACED WITH MDF BS476 part22 FD30
- 2- FRAME: TIMBER
- 3- ARCHITRAVE: TIMBER
- 4- FINISH: HAND PAINTED
- 5- HINGES: TBS
- 6- FIRE REG: -
- 7- HANDLE: TBC
- 8- LOCK: TBC

FIRE RATING 30 MINUTES

FRAME DETAILS SCALE 1:5

SECTION DETAILS

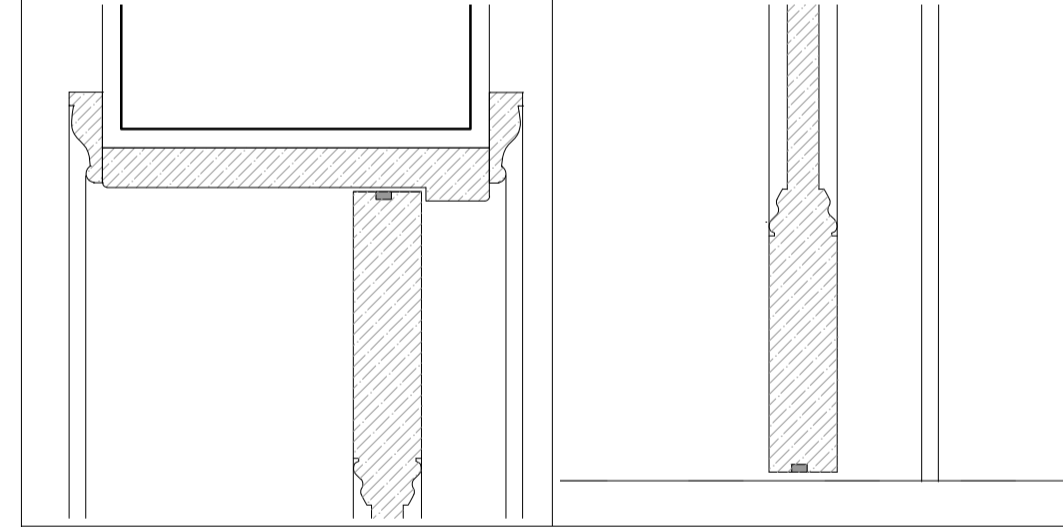

PLAN SECTION

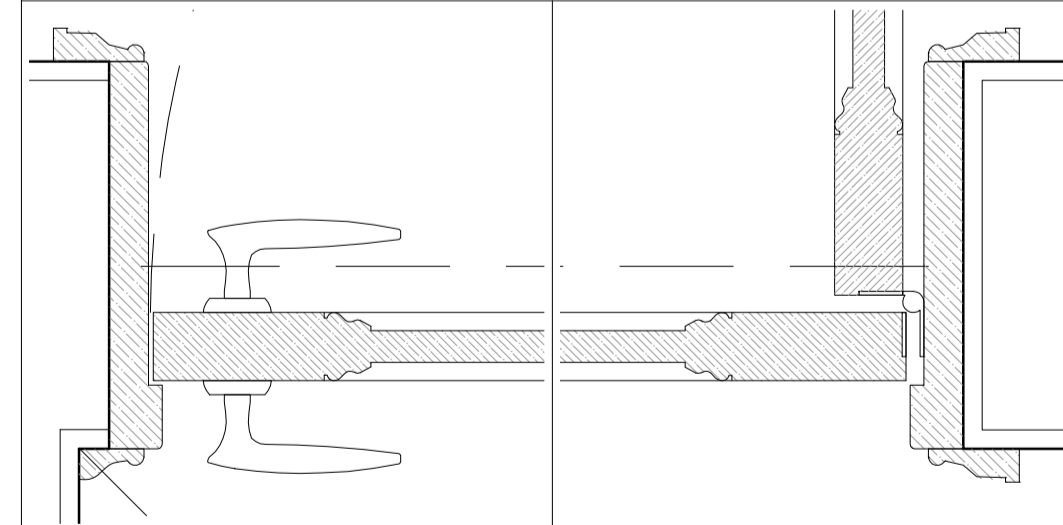

SUPPLY BY CUSTOM MADE

DR-05

SCALE 1:20

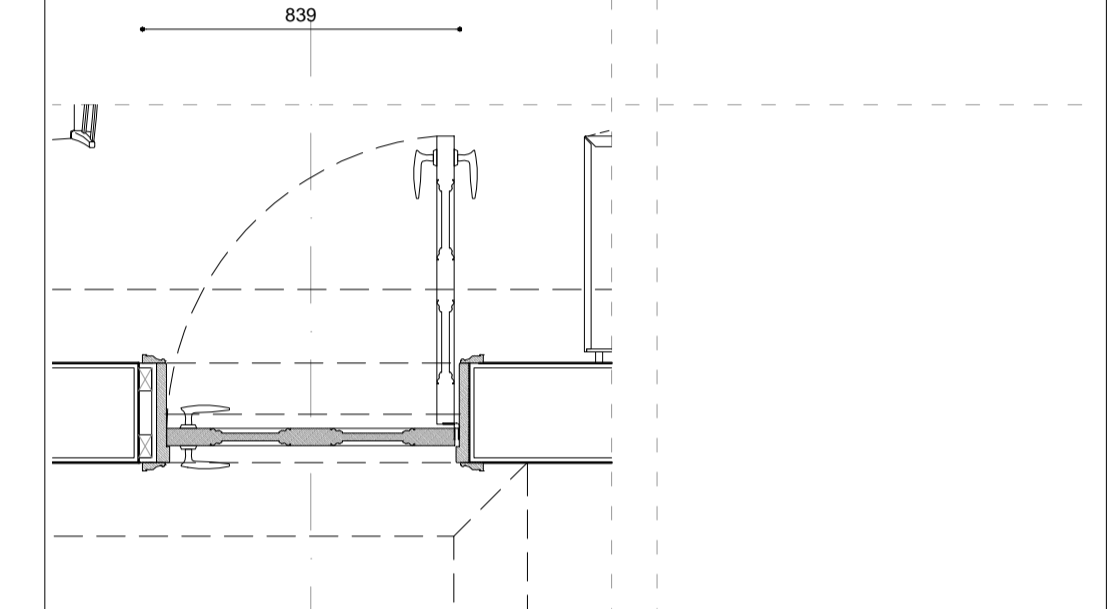
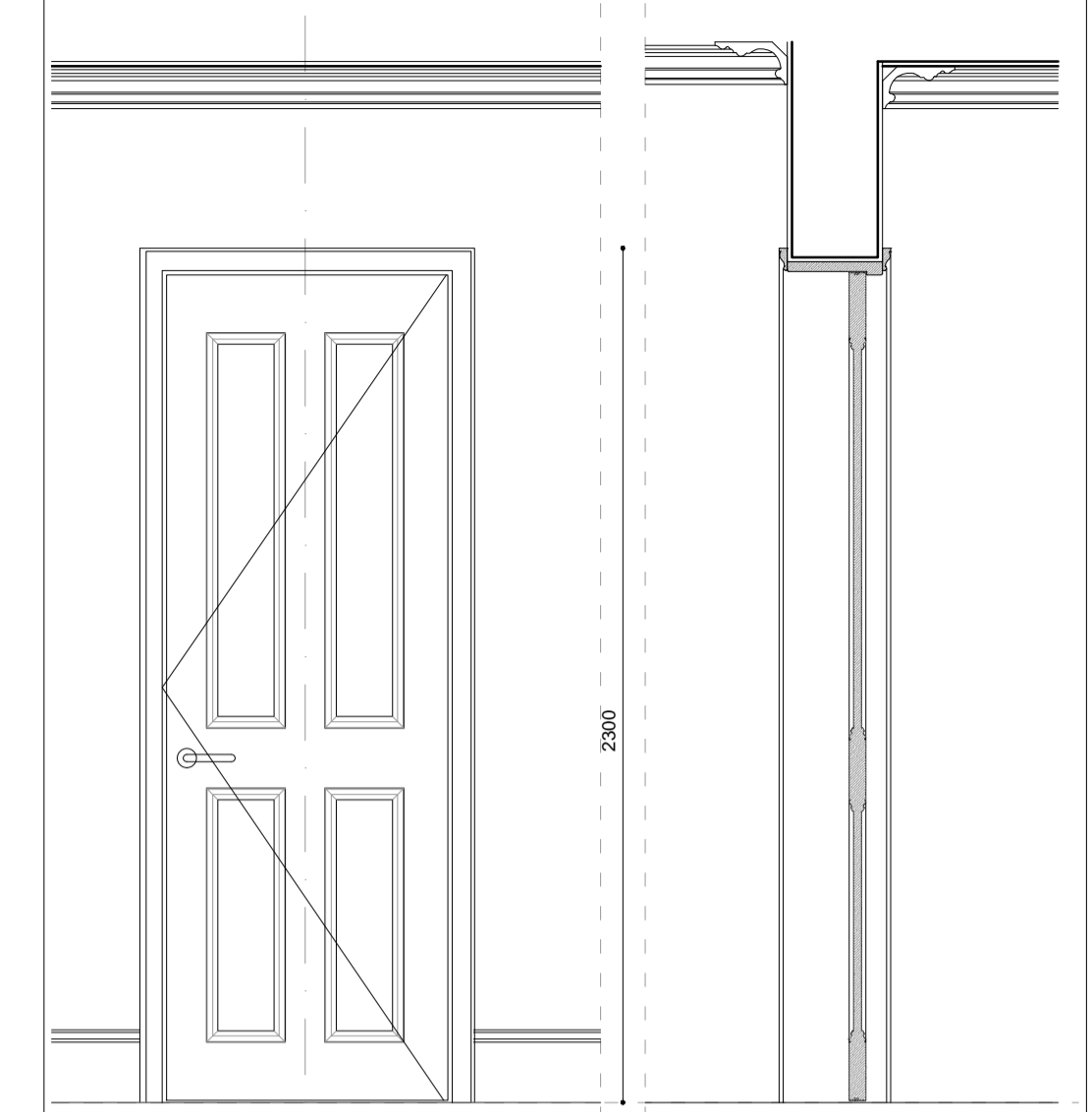

DESCRIPTION

- 1- DOOR LEAF: LAMINESSE FIRE SMOKE SPRUCE LAMINATE CORE FACED WITH MDF BS476 part22 FD30
- 2- FRAME: TIMBER
- 3- ARCHITRAVE: TIMBER
- 4- FINISH: HAND PAINTED
- 5- HINGES: TBS
- 6- FIRE REG: -
- 7- HANDLE: TBC
- 8- LOCK: TBC

FIRE RATING 30 MINUTES

FRAME DETAILS SCALE 1:5

SECTION DETAILS

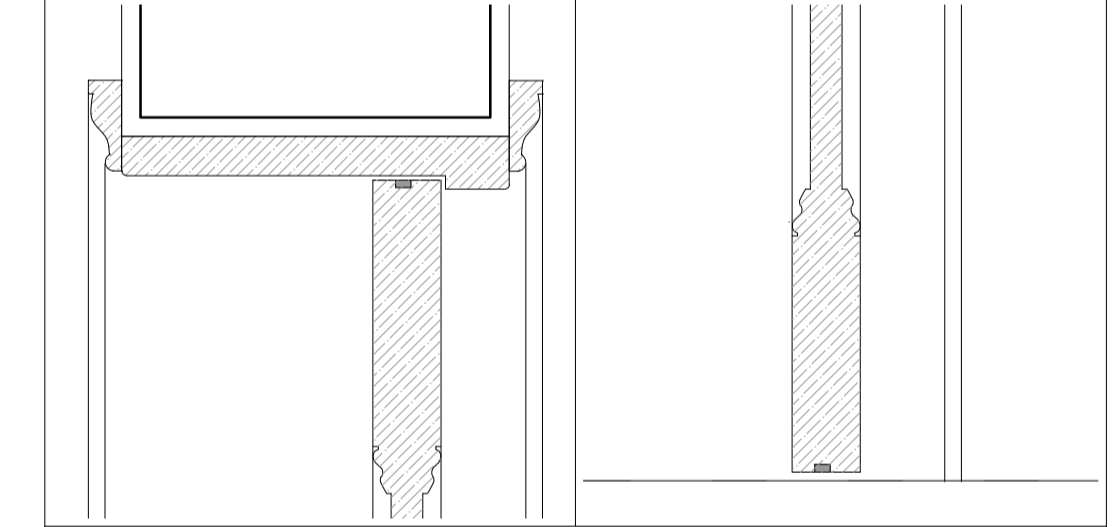

PLAN SECTION

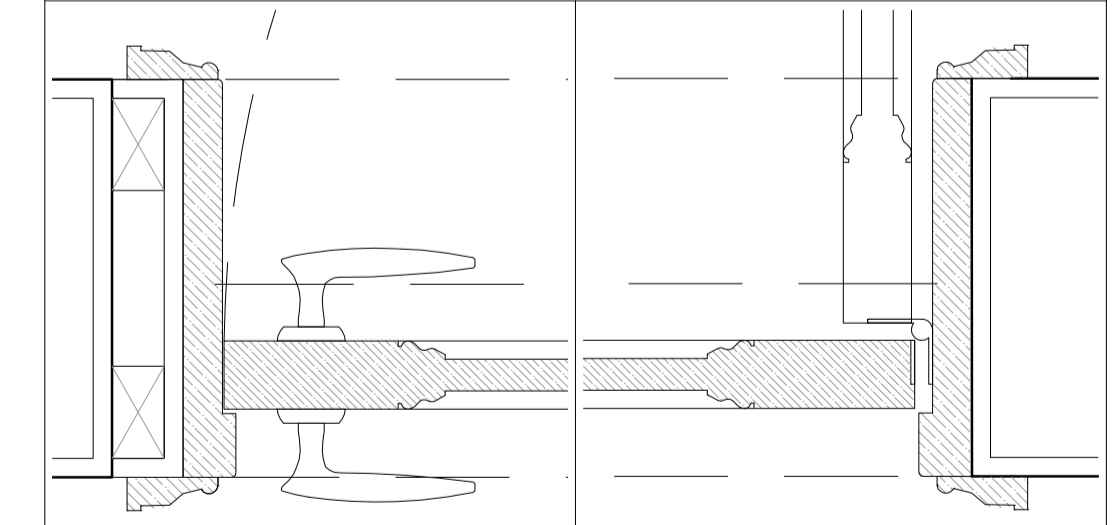

SUPPLY BY CUSTOM MADE

LBMV architects

Lug Morrellsco Ltd.
27 Essex Street, NW1 4UH, London
T+44 (0) 207 483 3880
www.lbmvarchitects.com

STAGE B
PROJECT TITLE
SIDE EXTENSION
REAR EXTENSION
INTERNAL ALTERATIONS

05 Lyndhurst Gardens
NW3 5NR

DATE
02.08.2016
SCALE
1:20@A1

JOB NO
0050
DRAWING NO
A8001

GENERAL NOTE
1. This drawing should be removed from currency immediately when a revised version is issued.
2. All dimensions to be checked on site by the contractor. Discrepancies to be reported before proceeding with the works.
3. This drawing is copyrighted.
4. All dimensions in mm's.
5. All structural elements size and position to be verified from structural engineer drawings.
6. All services to be designed by contractor.
7. All skylights to be cleaned by specialist company.

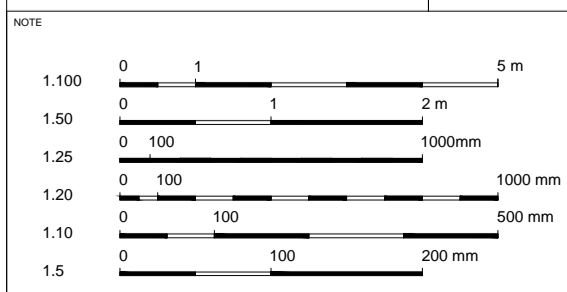

REV	DESCRIPTION	DATE	NAME
01		04/01/2017	000
02		07/12/2016	000
03		02/12/2016	000

DR-06

SCALE 1:20

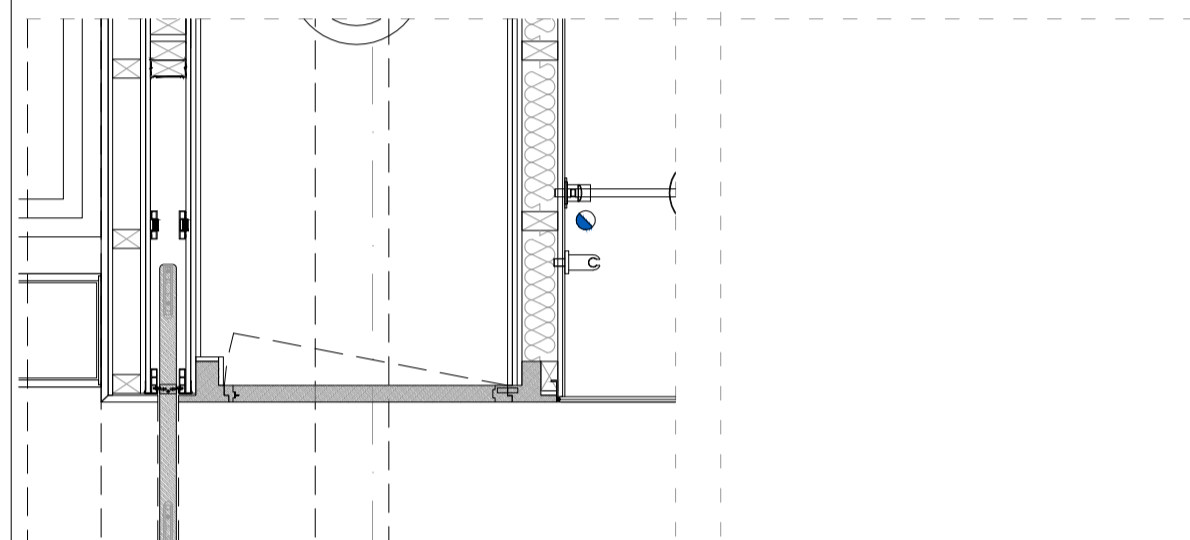
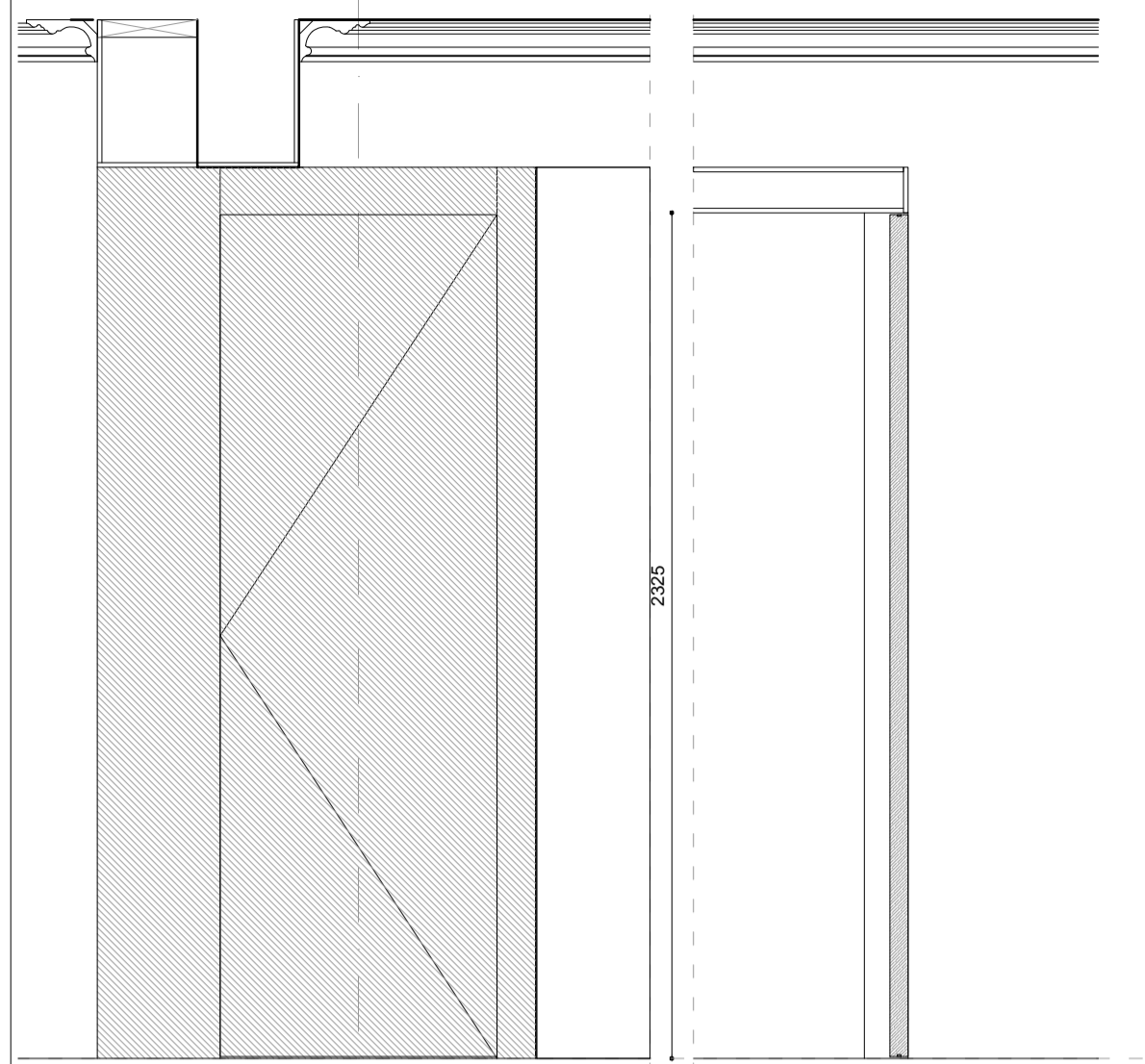

DESCRIPTION
 1- DOOR LEAF: LAMINÉSSE FIRE SMOKE SPRUCE LAMINATE CORE FACED WITH MDF BS476 part22 FD30
 2- FRAME: SOLID TIMBER - SOUNDPROOF PLASTIC SEAL
 3- ARCHITRAVE: SOLID TIMBER
 4- FINISH: OAK VENEER TBC
 5- HINGES: SOSS HINGES - HAFELE WITH SOFT CLOSING
 6- FIRE REG: INTUMESCED STRIP AND SMOKE SEAL ALL AROUND THE PERIMETER
 7- HANDLE: TBS
 8- LOCK: TBS

FIRE RATING

FRAME DETAILS SCALE 1:5

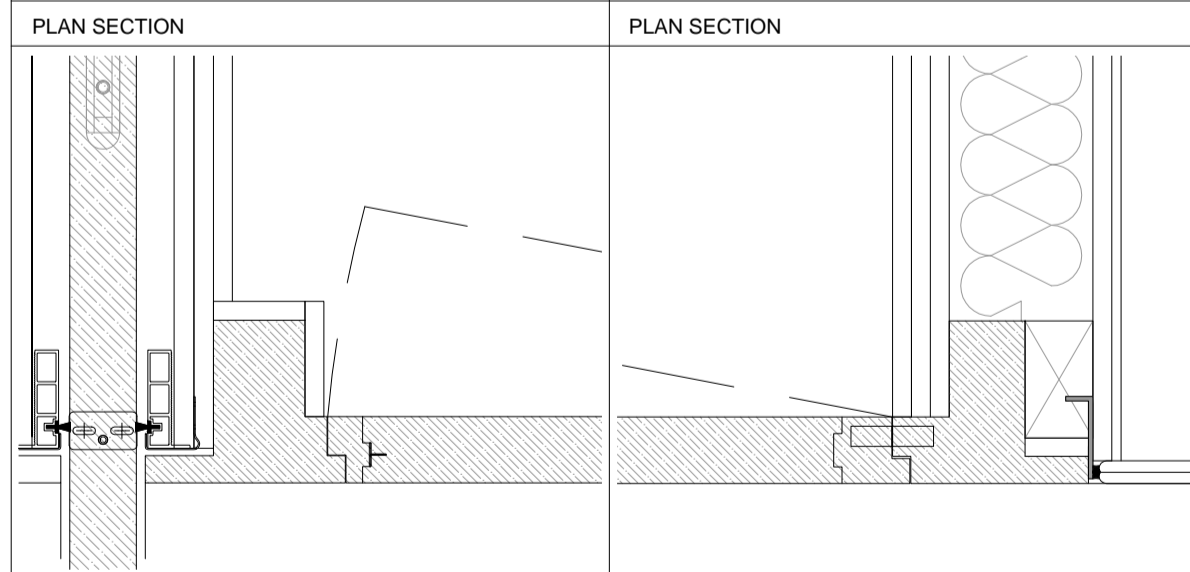
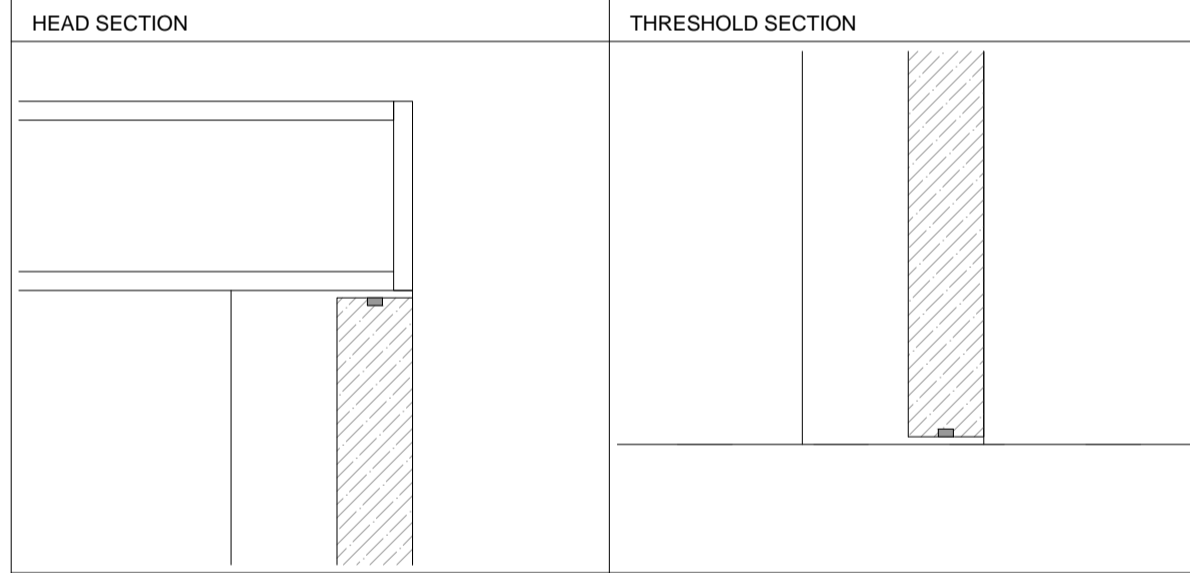

SUPPLY BY CUSTOM MADE

DR-07

SCALE 1:20

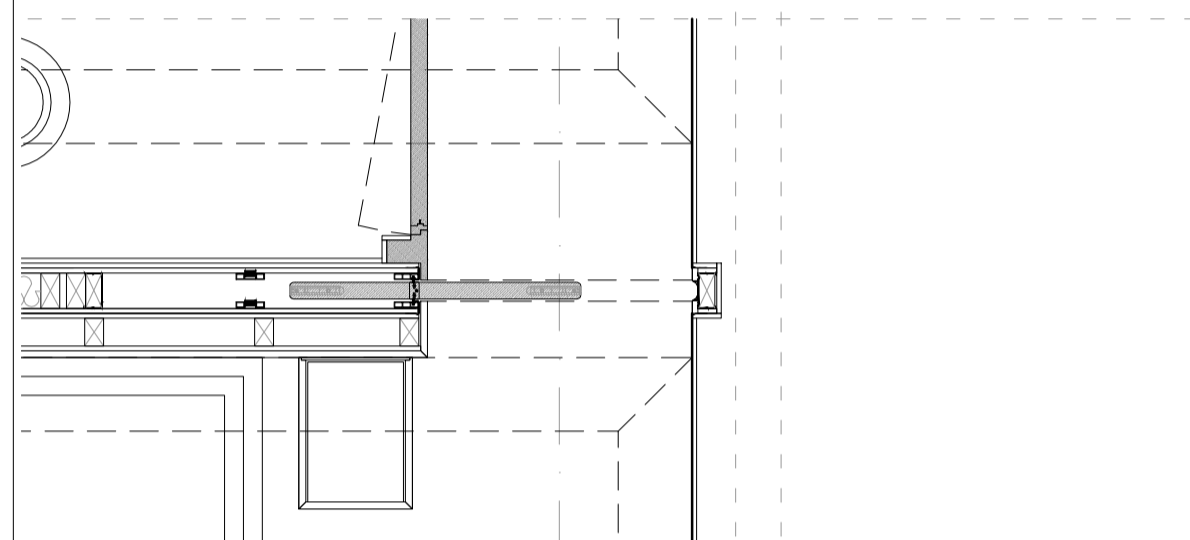
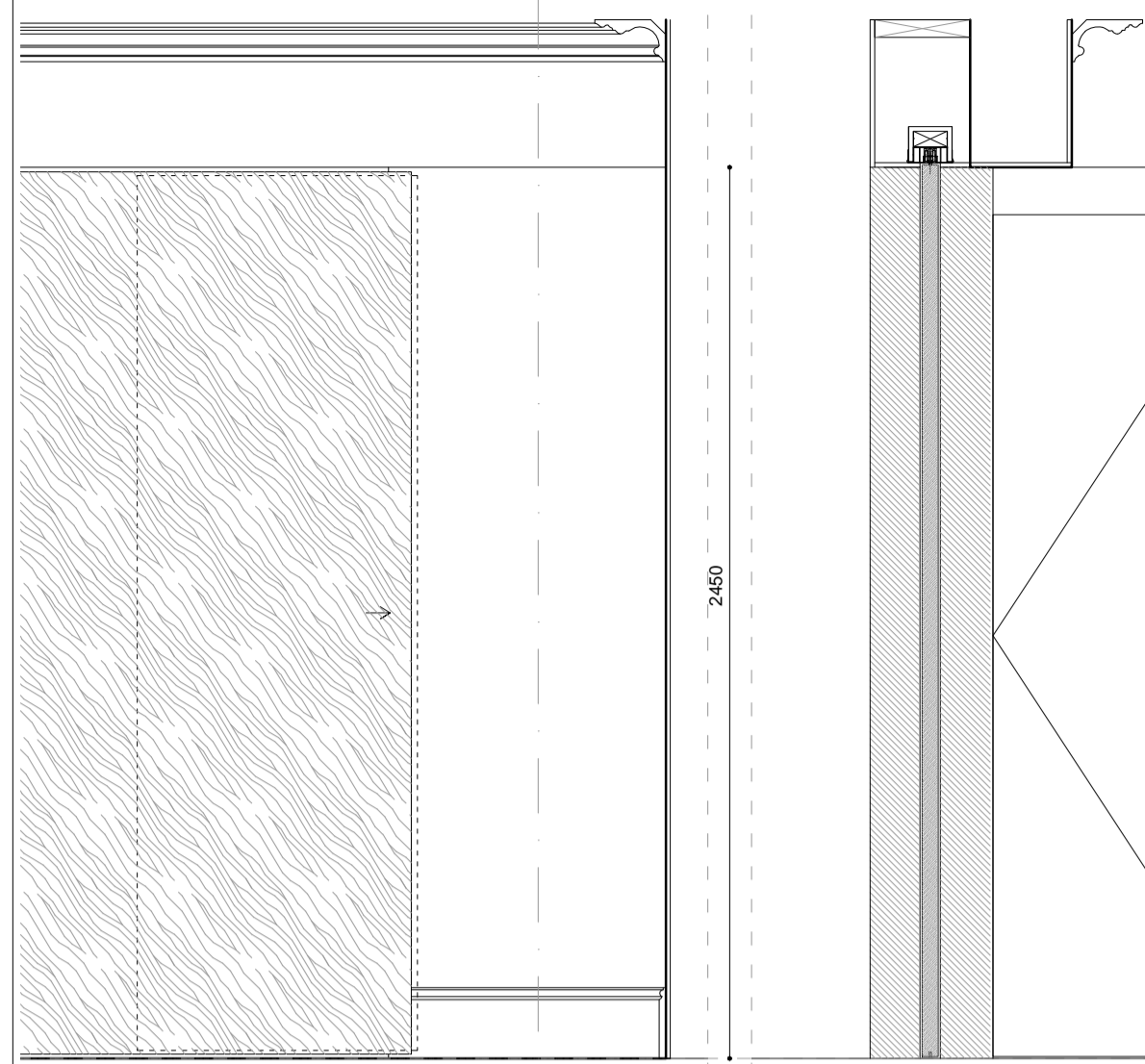

DESCRIPTION
 1- DOOR LEAF: LAMINÉSSE FIRE SMOKE SPRUCE LAMINATE CORE FACED WITH MDF BS476 part22 FD30
 2- FRAME: SOLID TIMBER
 3- ARCHITRAVE: SOLID TIMBER
 4- FINISH: TBS
 5- TRACKS: CONTRACTOR TO SPECIFY
 6- FIRE REG: INTUMESCED STRIP AND SMOKE SEAL ALL AROUND THE PERIMETER
 7- HANDLE: TBC
 8- LOCK: TBC

FIRE RATING

FRAME DETAILS SCALE 1:5

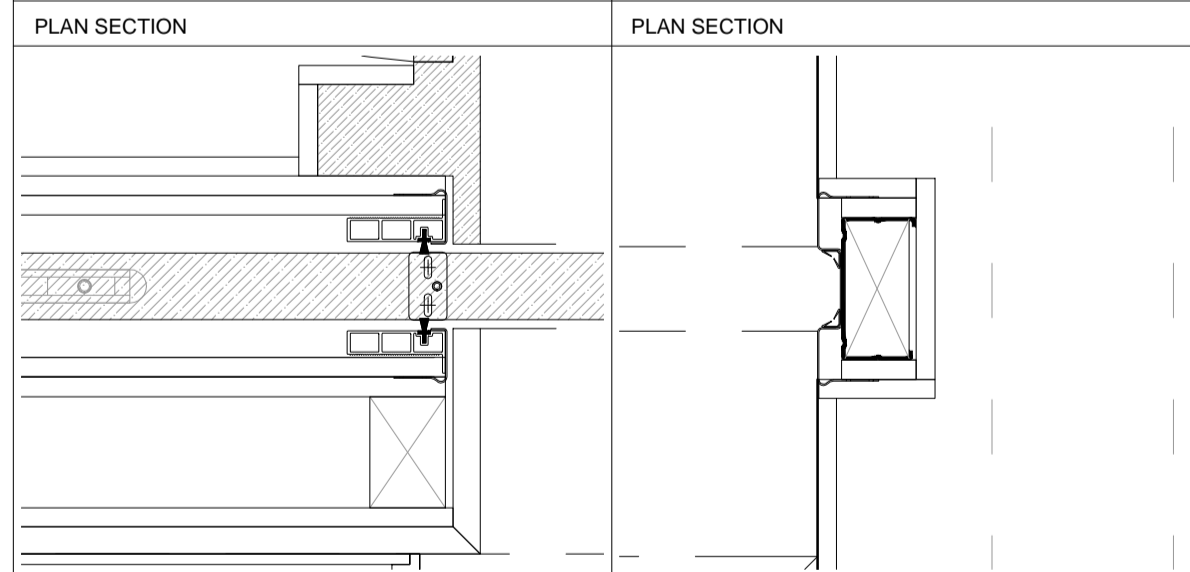
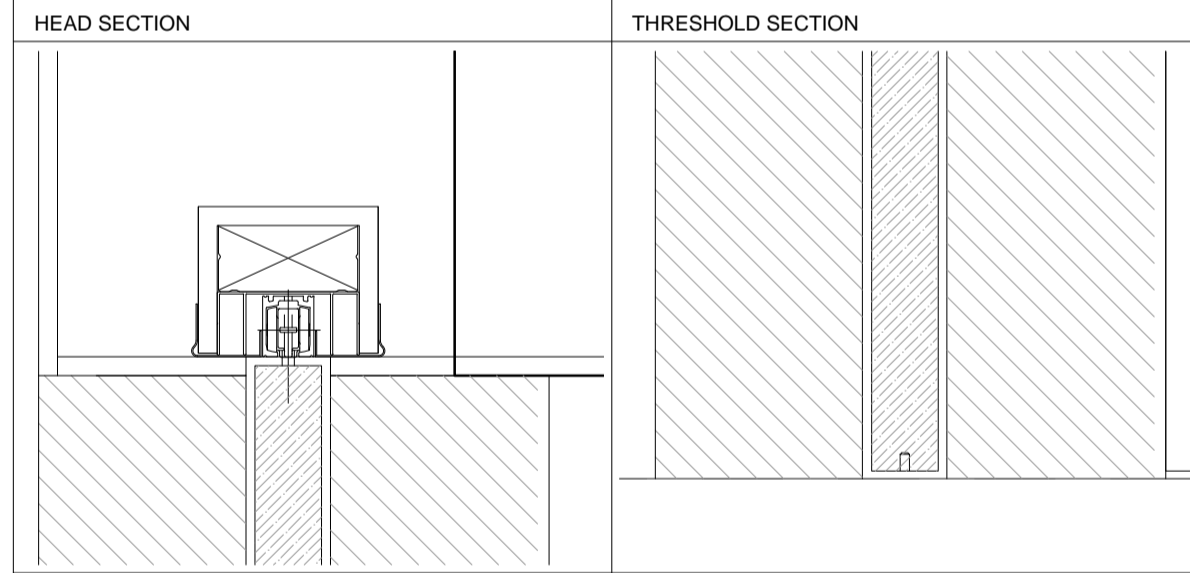

SUPPLY BY CUSTOM MADE

DR-08

SCALE 1:20

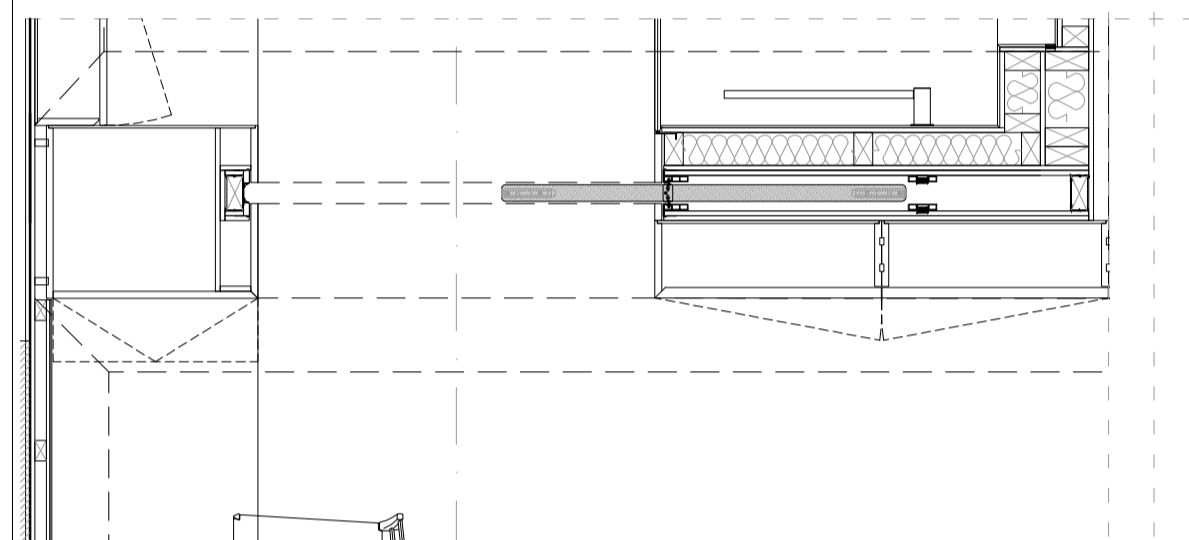
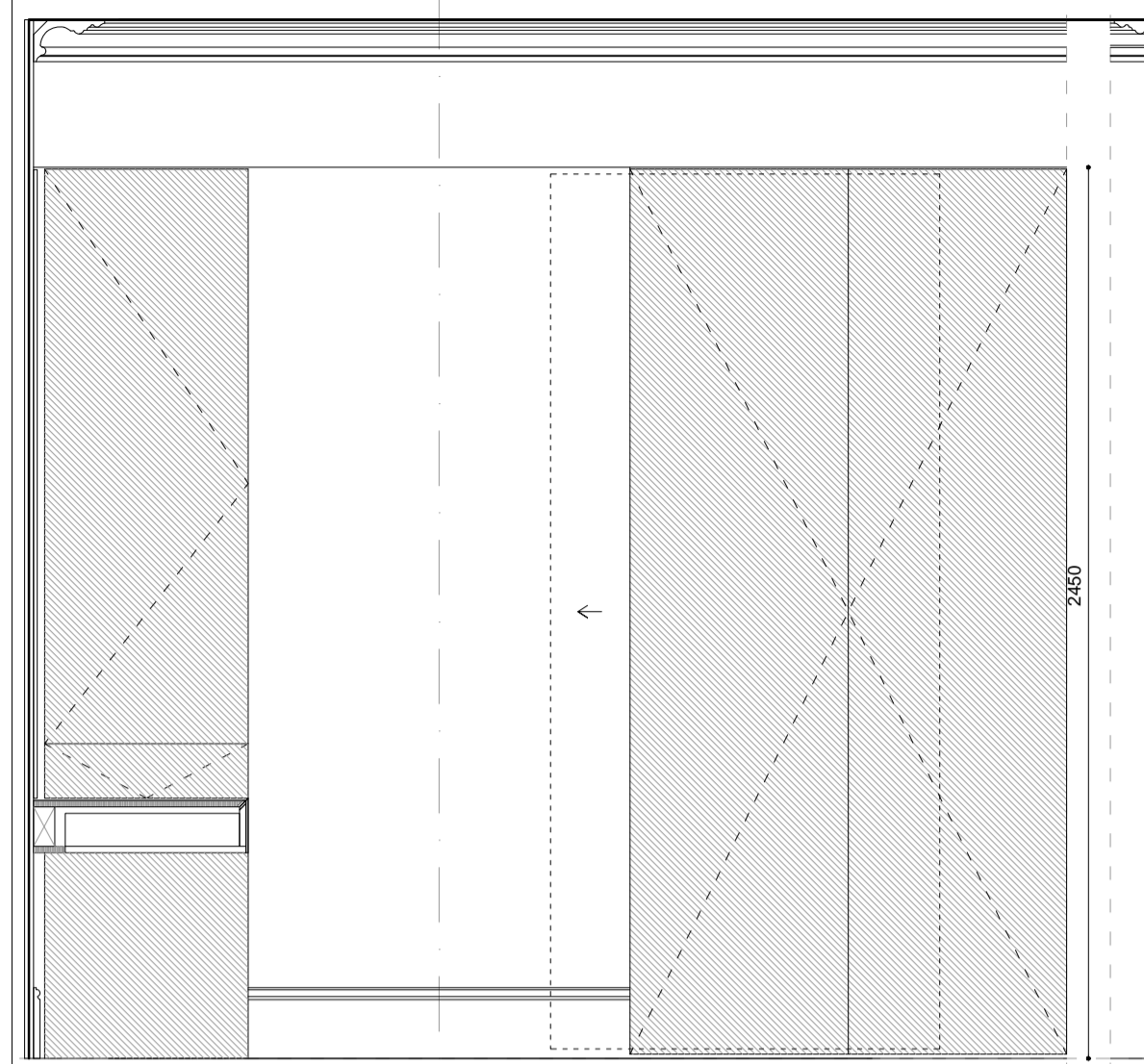

DESCRIPTION
 1- DOOR LEAF: LAMINÉSSE FIRE SMOKE SPRUCE LAMINATE CORE FACED WITH MDF BS476 part22 FD30
 2- FRAME: SOLID TIMBER
 3- ARCHITRAVE: SOLID TIMBER
 4- FINISH: TBS
 5- TRACKS: CONTRACTOR TO SPECIFY
 6- FIRE REG: INTUMESCED STRIP AND SMOKE SEAL ALL AROUND THE PERIMETER
 7- HANDLE: TBC
 8- LOCK: TBC

FIRE RATING

FRAME DETAILS SCALE 1:5

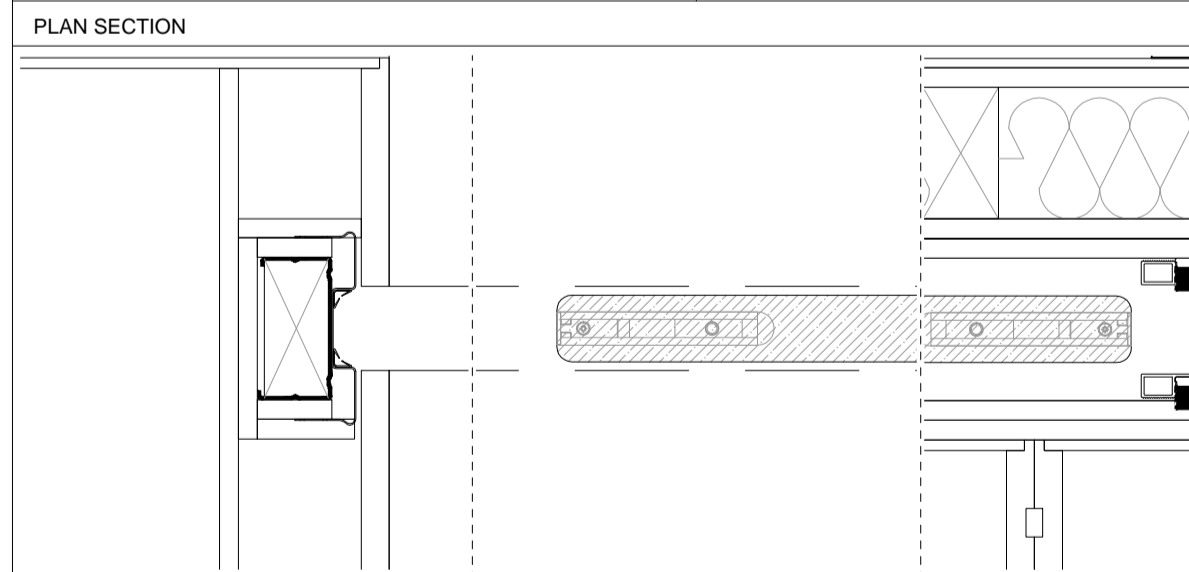
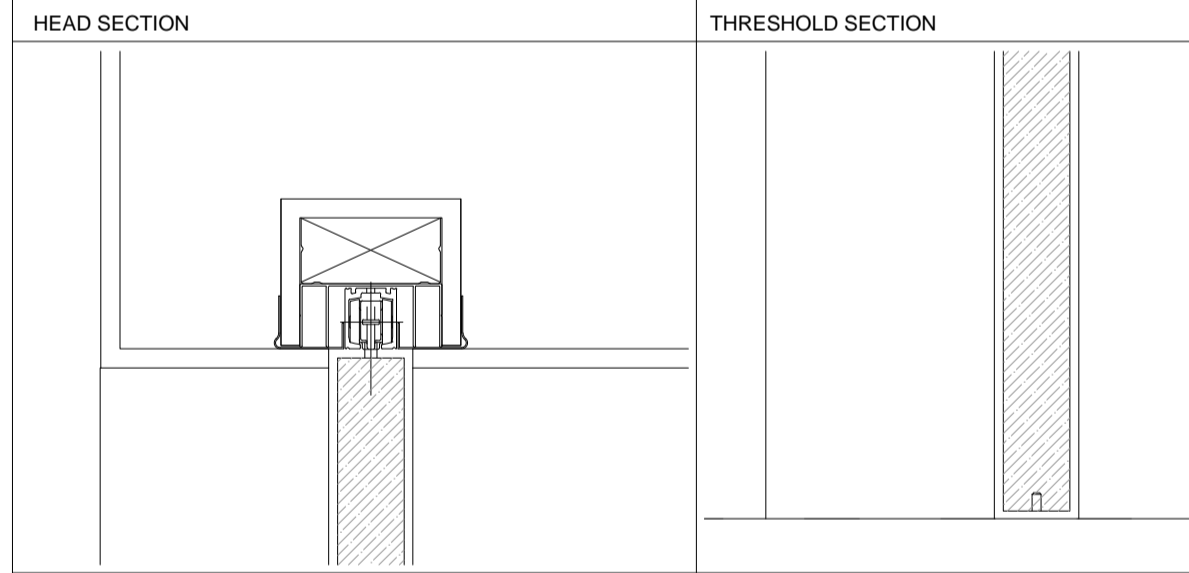

SUPPLY BY CUSTOM MADE

DR-09

SCALE 1:20

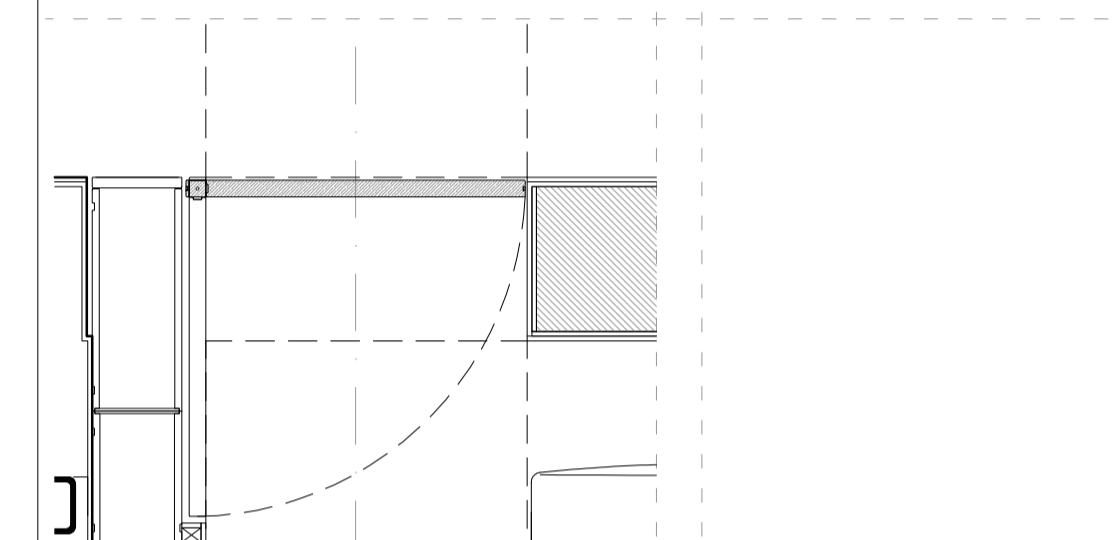
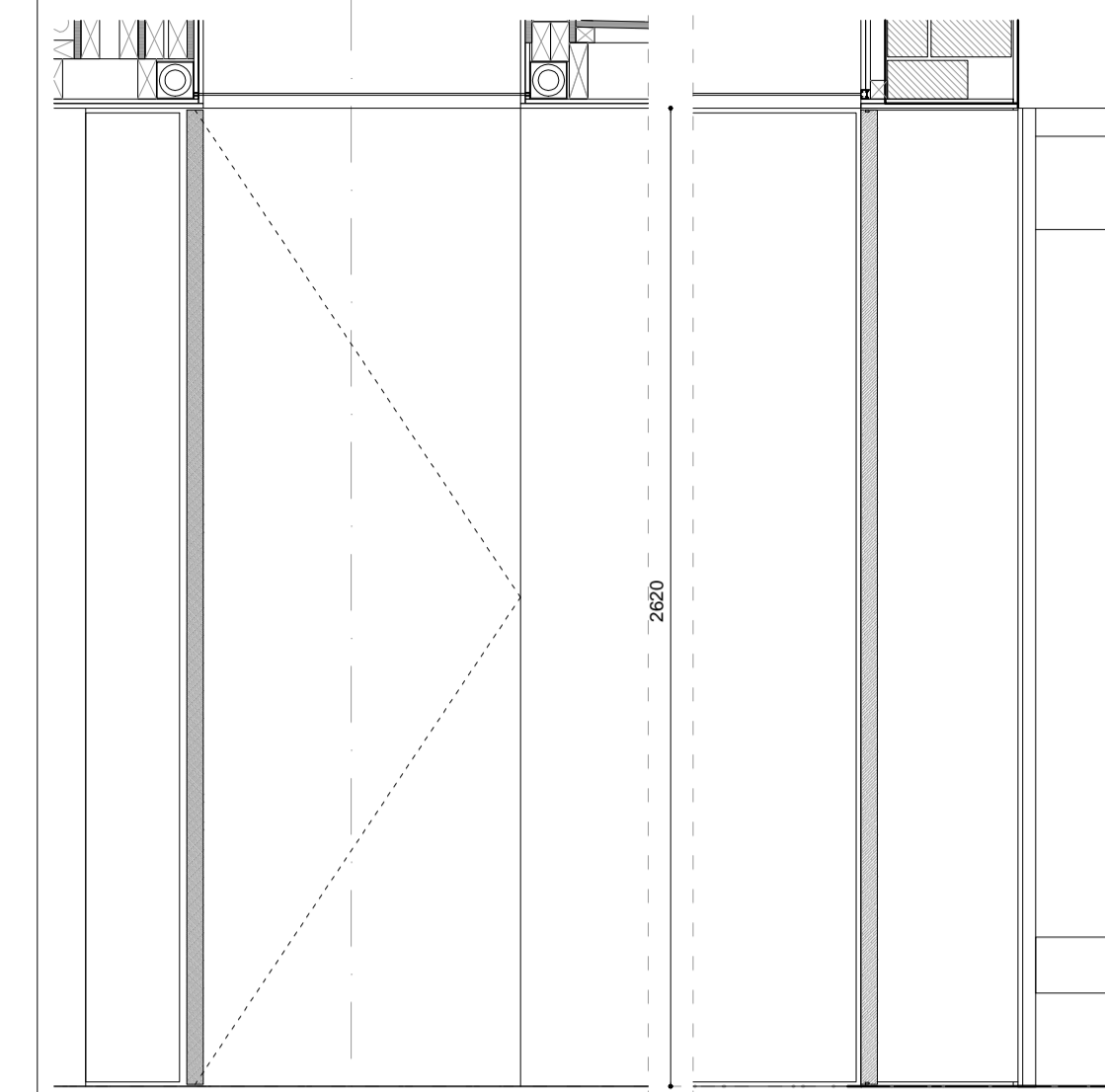

DESCRIPTION
 1- DOOR LEAF: LAMINÉSSE FIRE SMOKE SPRUCE LAMINATE CORE FACED WITH MDF BS476 part22 FD30
 2- FRAME: SOLID TIMBER - SOUNDPROOF PLASTIC SEAL
 3- ARCHITRAVE: SOLID TIMBER
 4- FINISH: TBS
 5- HINGES: PIVOT HINGES
 6- FIRE REG: INTUMESCED STRIP AND SMOKE SEAL ALL AROUND THE PERIMETER
 7- HANDLE: TBS
 8- LOCK: TBS

FIRE RATING

FRAME DETAILS SCALE 1:5

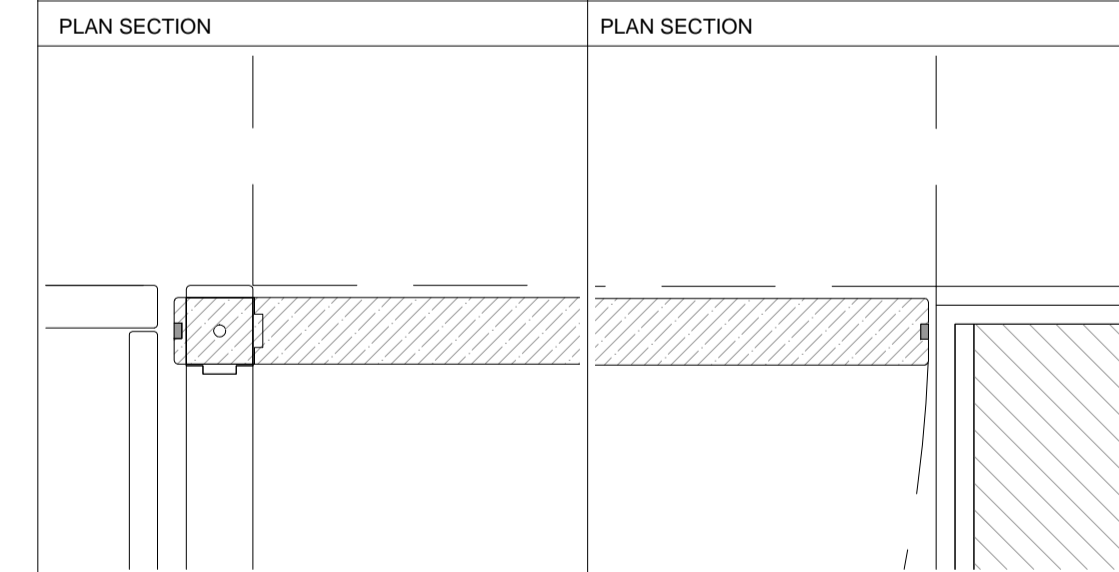
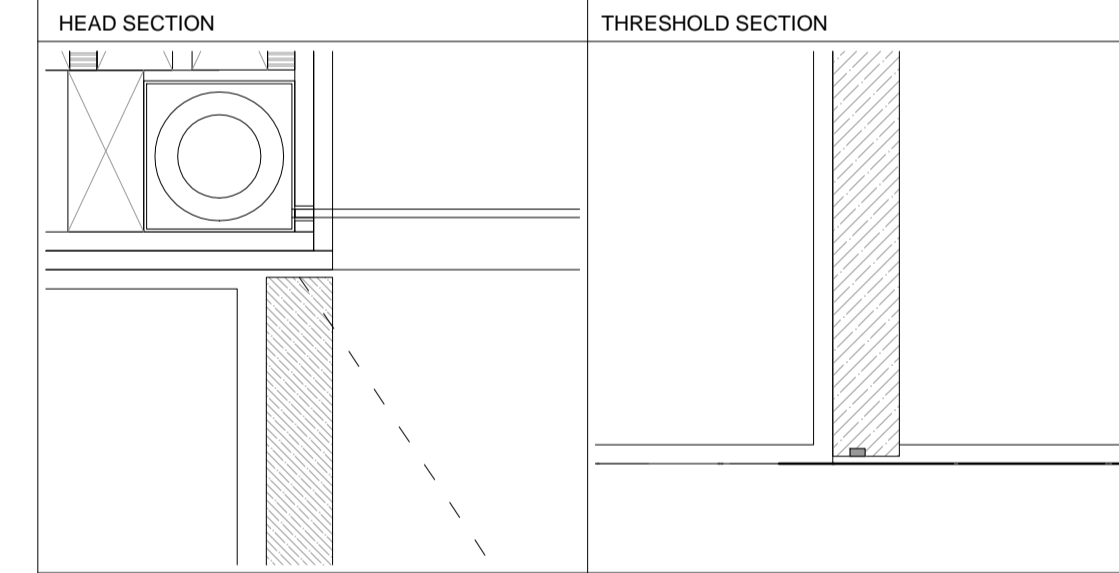

SUPPLY BY CUSTOM MADE

LBMV architects

Lug Morosocco Ltd.
 27 Essex Road, NW3 4JH, London
 T+44 (0) 207 483 3880
 info@lvmv.com
 www.lvmv.com

STAGE B

A1

DATE: 02.08.2016

SCALE: 1:20@A1

PROJECT TITLE:
 SIDE EXTENSION
 REAR EXTENSION
 INTERNAL ALTERATIONS

DRAWING TITLE:
 SCHEDULE OF PROPOSED
 DOORS

JOB NO: 0050

DRAWING NO: A8002

GENERAL NOTE
 1. This drawing should be removed from currency immediately when a revised version is issued.
 2. All dimensions to be checked on site by the contractor. Discrepancies to be reported before proceeding with the work.
 3. This drawing is copyrighted.
 4. All dimensions in mm's.
 5. All structural elements size and position to be verified from structural engineer drawings.
 6. All services to be designed by contractor.
 7. All skylights to be cleaned by specialist company.

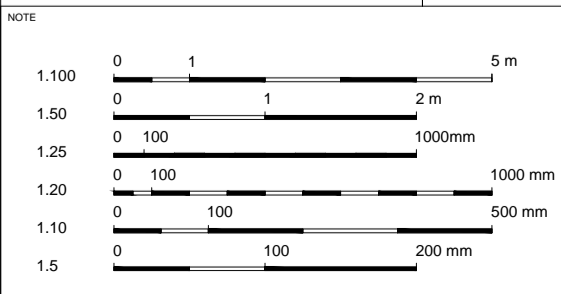

REV	DESCRIPTION	DATE	NAME
04		04/01/2017	000
05		07/12/2016	000
06		02/12/2016	000

DR-10

SCALE 1:20

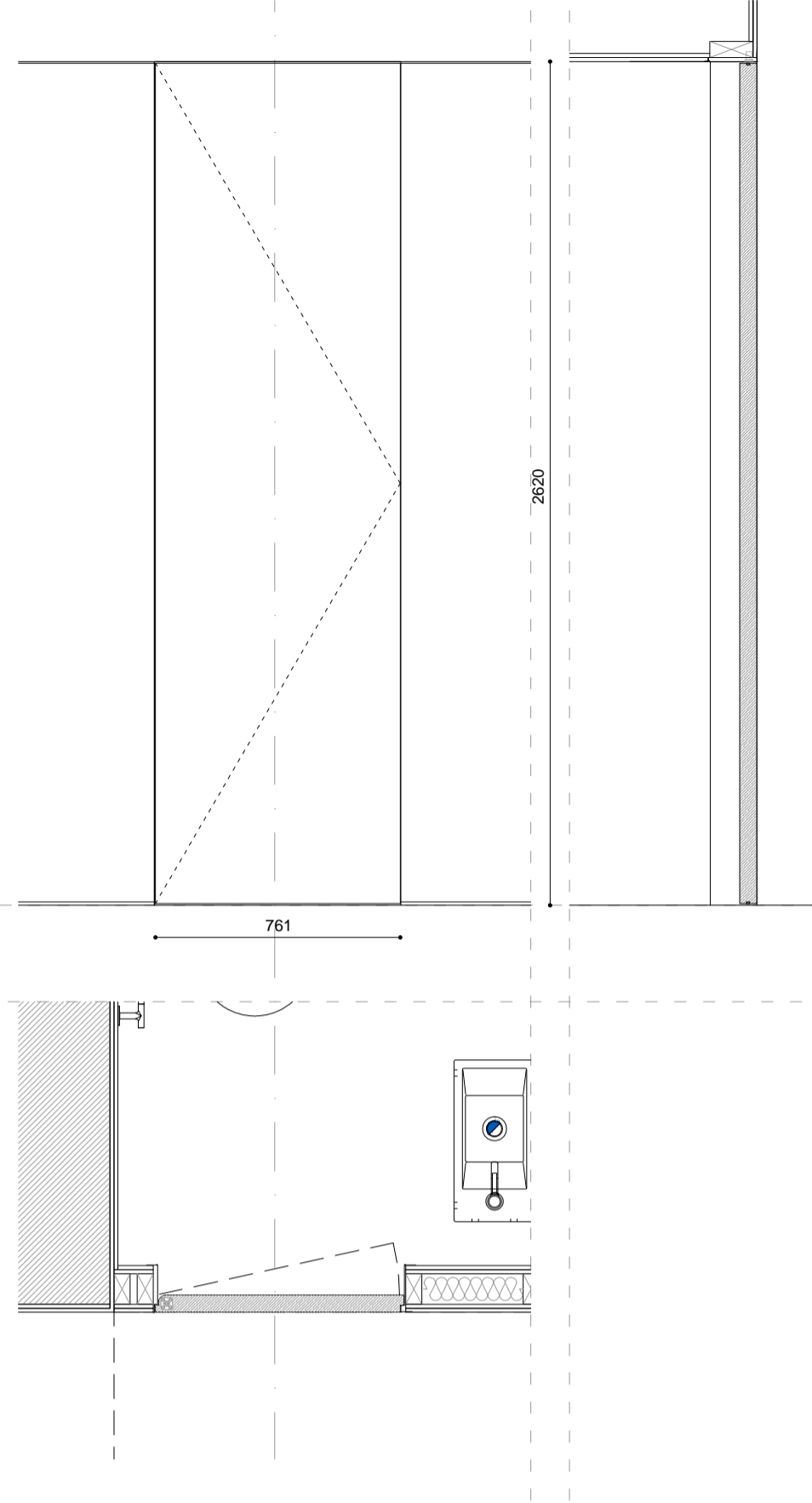

DESCRIPTION - SELO, INNOVA PIVOT HINGED DOOR

- 1- DOOR LEAF: SEE INNOVA SPECIFICATIONS
- 2- FRAME: SEE INNOVA SPECIFICATIONS
- 3- ARCHITRAVE: SEE INNOVA SPECIFICATIONS
- 4- FINISH: HAND PAINTED FINISH
- 5- HINGES: SEE INNOVA SPECIFICATIONS
- 6- FIRE REG: TBC
- 7- HANDLE: TBC
- 8- LOCK: TBC

FIRE RATING NO

FRAME DETAILS SCALE 1:5

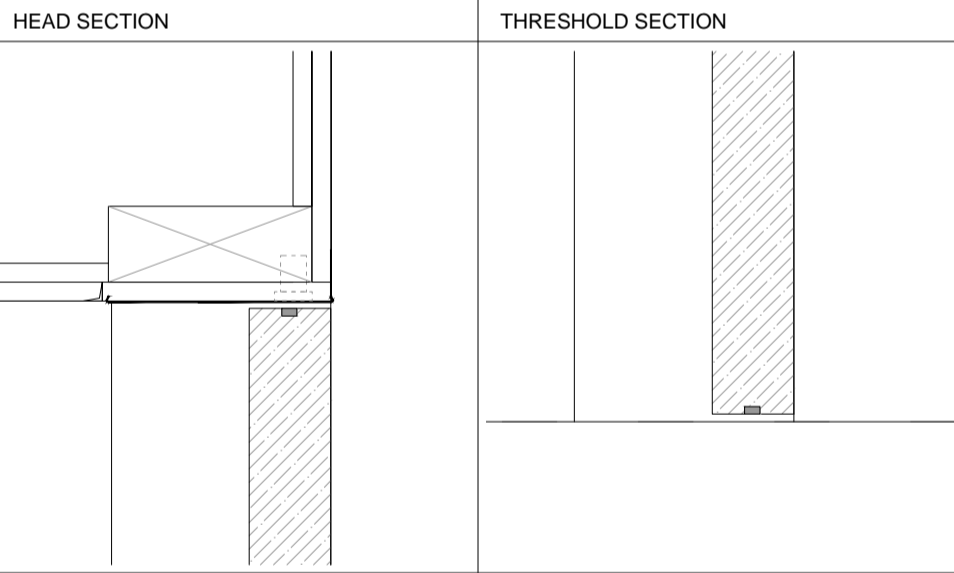

PLAN SECTION

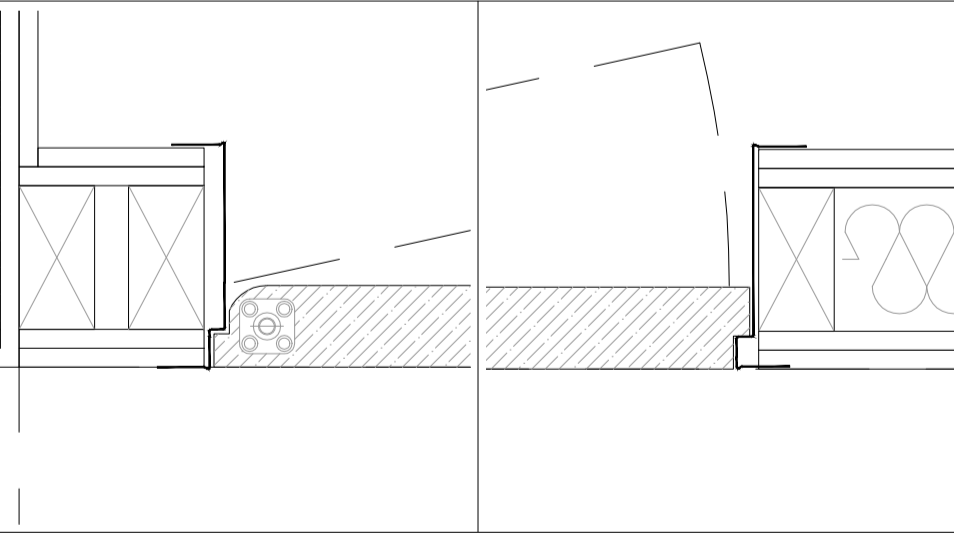

SUPPLY BY SELO

DR-11

SCALE 1:20

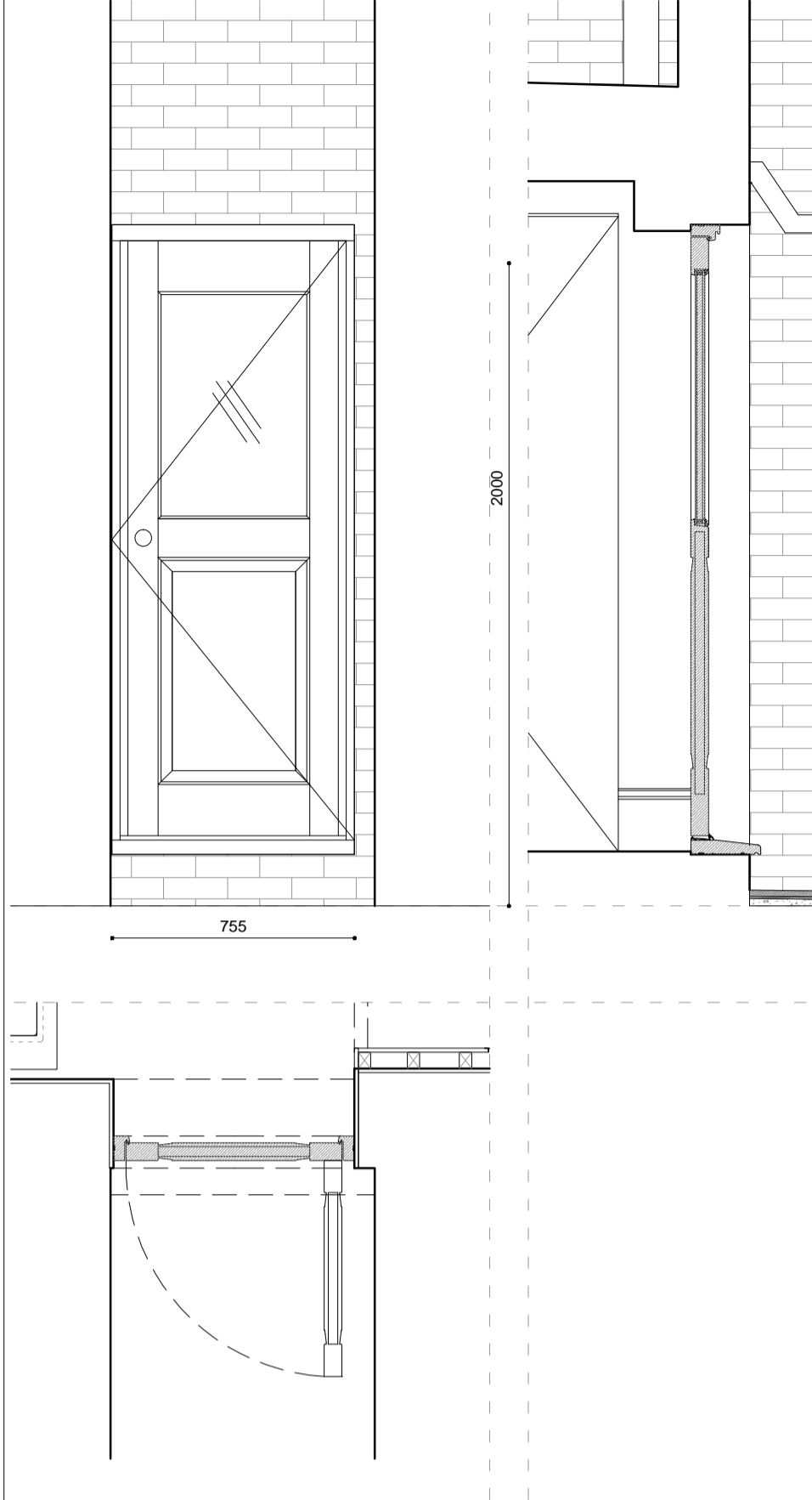

DESCRIPTION

- 1- DOOR LEAF: LAMINATE FIRE SMOKE SPRUCE LAMINATE CORE FACED WITH MDF BS476 part22 FD30
- 2- FRAME: SOLID TIMBER - SOUNDPROOF PLASTIC SEAL
- 3- ARCHITRAVE: NEW 50 mm SOLID TIMBER
- 4- FINISH: HAND PAINTED WHITE
- 5- HINGES: HAFELE - WITH SOFT CLOSING
- 6- FIRE REG: NONE
- 7- HANDLE: TBS
- 8- LOCK: TBS

FIRE RATING

FRAME DETAILS SCALE 1:5

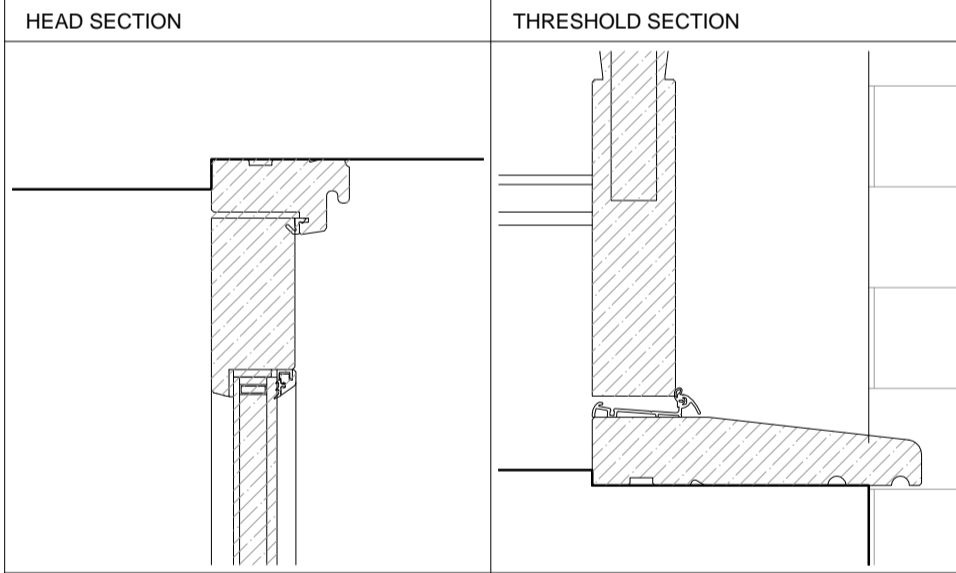

PLAN SECTION

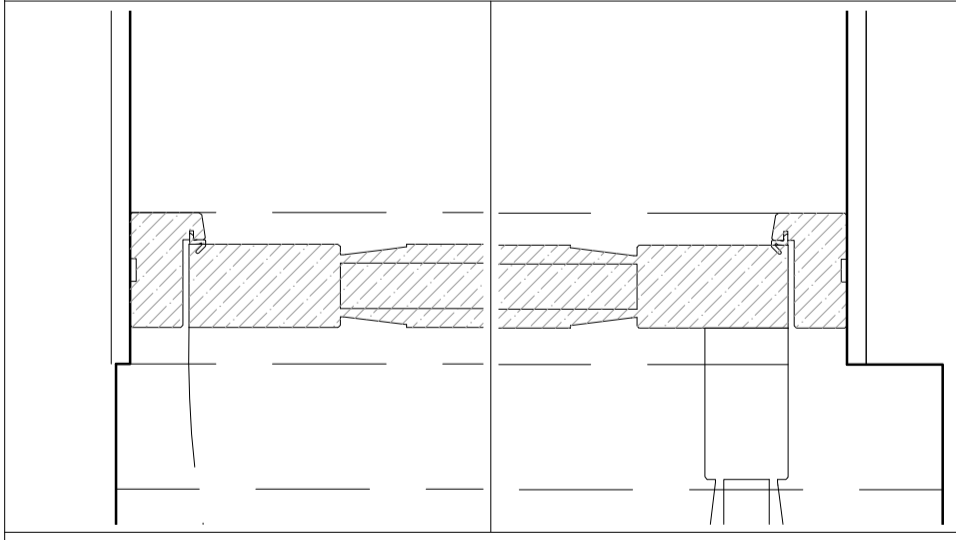

SUPPLY BY CUSTOM MADE

DR-12

SCALE 1:20

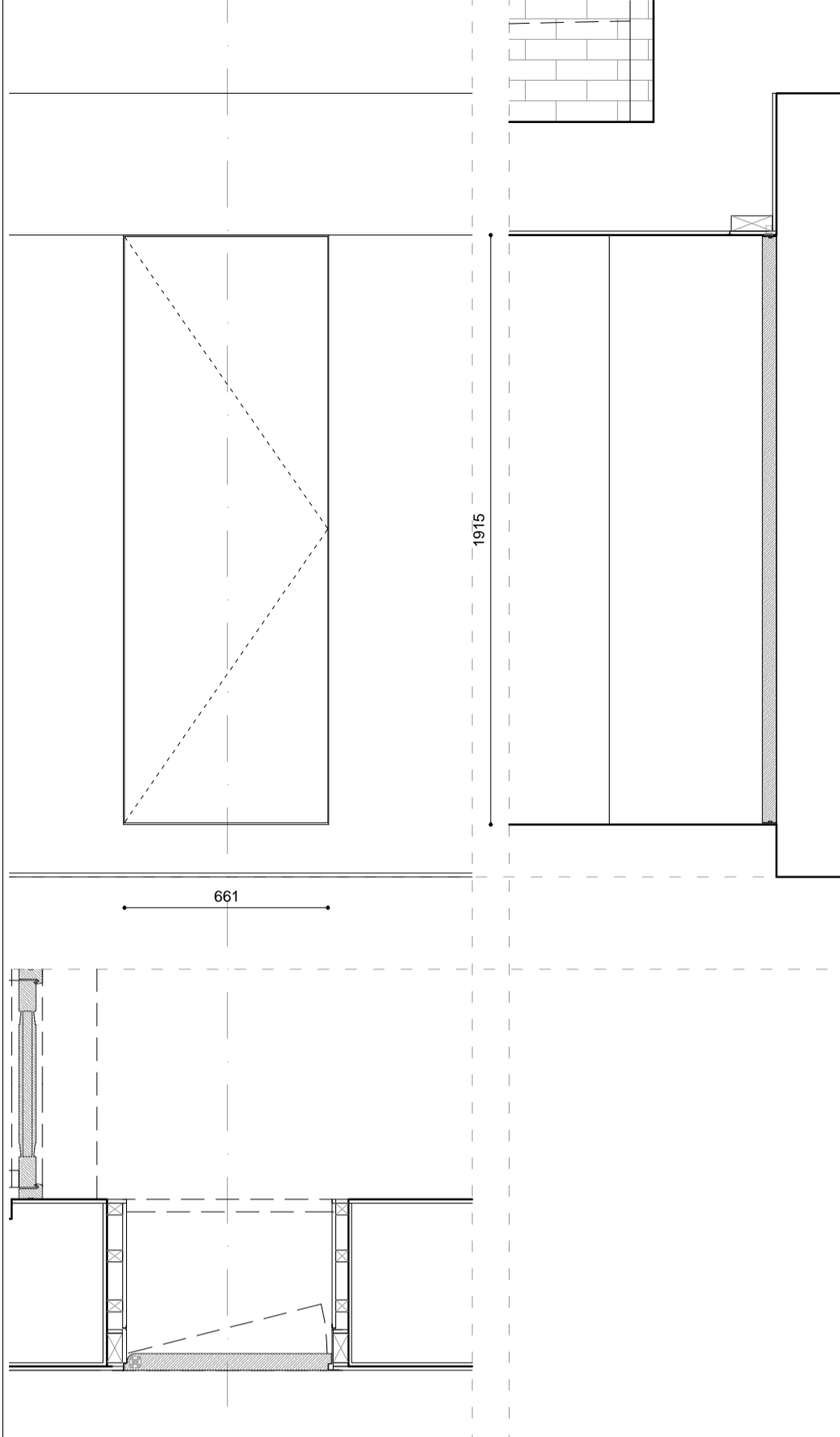

DESCRIPTION - SELO, INNOVA PIVOT HINGED DOOR

- 1- DOOR LEAF: SEE INNOVA SPECIFICATIONS
- 2- FRAME: SEE INNOVA SPECIFICATIONS
- 3- ARCHITRAVE: SEE INNOVA SPECIFICATIONS
- 4- FINISH: HAND PAINTED FINISH
- 5- HINGES: SEE INNOVA SPECIFICATIONS
- 6- FIRE REG: TBC
- 7- HANDLE: TBC
- 8- LOCK: TBC

FIRE RATING

FRAME DETAILS SCALE 1:5

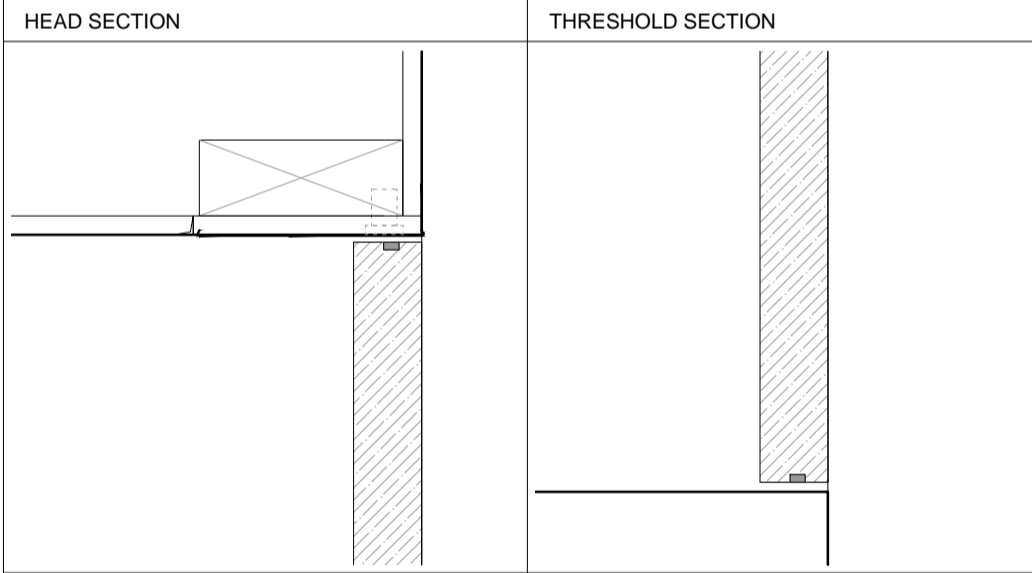

PLAN SECTION

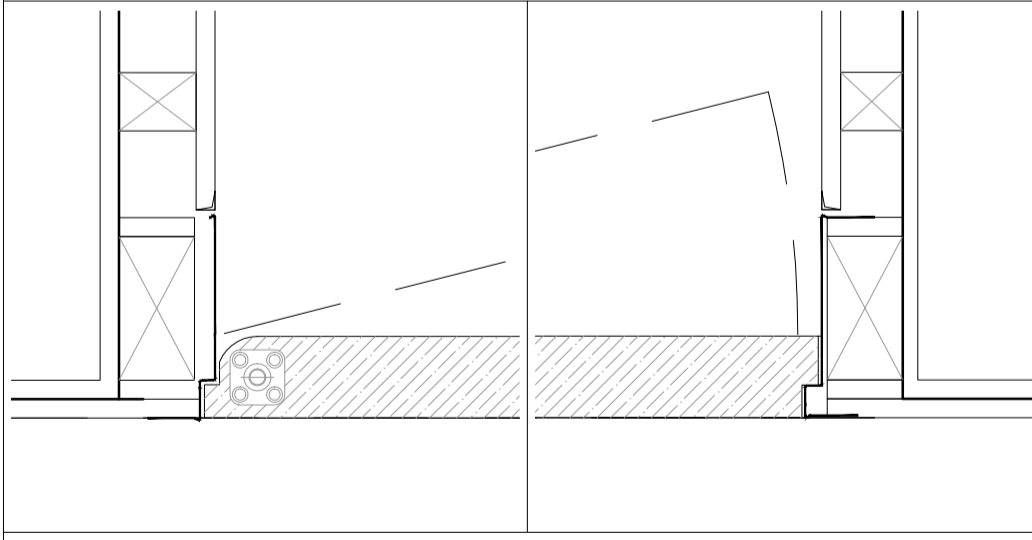

SUPPLY BY SELO

LBMV architects

Lug Morrellsco Ltd
27 Essex Street, NW3 4UH, London
T+44 (0) 207 483 3880
lvm@lvmarchitects.com
www.lvmarchitects.com

STAGE B
PROJECT TITLE
SIDE EXTENSION
REAR EXTENSION
INTERNAL ALTERATIONS
05 Lyndhurst Gardens
NW3 5NR

DATE
02.08.2016
SCALE
1:20@A1
JOB NO
0050
DRAWING NO
A8003

- GENERAL NOTE**
1. This drawing should be removed from currency immediately when a revised version is issued.
 2. All dimensions to be checked on site by the contractor. Discrepancies to be reported before proceeding with the work.
 3. This drawing is copyrighted.
 4. All dimensions in mm's.
 5. All structural elements size and position to be verified from structural engineer drawings.
 6. All services to be designed by contractor.
 7. All skylights to be cleaned by specialist company.

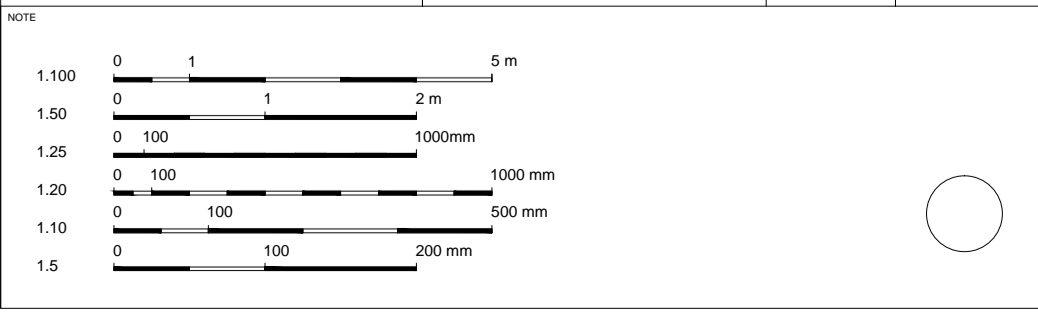

REV	DESCRIPTION	DATE	NAME
04		04/01/2017	000
05		07/12/2016	000
06		02/12/2016	000