

Camden Planning Guidance

# Design

London Borough of Camden

CPG **1**



July 2015



# CPG1 Design

1	Introduction.....	5
2	Design excellence .....	9
3	Heritage.....	15
4	Extensions, alterations and conservatories.....	29
5	Roofs, terraces and balconies .....	39
6	Landscape design and trees.....	49
7	Shopfronts.....	61
8	Advertisements, signs and hoardings .....	77
9	Designing safer environments .....	83
10	Recycling and Waste Storage .....	93
11	Building services equipment.....	101
12	Artworks, statues and memorials.....	105



# 1 Introduction

## What is Camden Planning Guidance?

- 1.1 We have prepared this Camden Planning Guidance to support the policies in our Local Development Framework (LDF). This guidance is therefore consistent with the Core Strategy and the Development Policies, and forms a Supplementary Planning Document (SPD) which is an additional “material consideration” in planning decisions. The Council adopted CPG1 Design on 6 April 2011 following statutory consultation. This document was updated in 2013 to include Section 12 on artworks, statues and memorials, and updated in 2015 to revise the guidance for recycling and waste storage. Details on these updates and the consultation process are available at [camden.gov.uk/cpg](http://camden.gov.uk/cpg).
- 1.2 The Camden Planning Guidance covers a range of topics (such as housing, sustainability, amenity and planning obligations) and so all of the sections should be read in conjunction, and within the context of Camden’s LDF.

## Design in Camden

- 1.3 Camden has many attractive and historic neighbourhoods as well as both traditional and modern buildings of the highest quality. These are a significant reason that the borough is such a popular place to live, work and visit. As well as conserving our rich heritage we should also contribute towards it by ensuring that we create equally high quality buildings and spaces which will be appreciated by future generations.
- 1.4 This objective of achieving high quality design does not just concern new development or large-scale schemes, but also includes the replacement, extension or conversion of existing buildings. The detailed guidance contained within this section therefore considers a range of design-related issues for both residential and commercial property and the spaces around them.



## What does this guidance cover?

1.5 This guidance provides information on all types of detailed design issues within the borough and includes the following sections:

1. Introduction
2. Design excellence
3. Heritage
4. Extensions, alterations and conservatories
5. Roofs, terraces and balconies
6. Landscape design and trees
7. Shopfronts
8. Advertisements, signs and hoardings
9. Designing safer environments
10. Waste recyclables storage
11. Building services equipment
12. Artworks, statues and memorials

1.6 This guidance supports the following Local Development Framework policies:

### Core Strategy

- CS14 Promoting high quality places and conserving our heritage
- CS15 Protecting and improving our parks and open spaces & encouraging biodiversity
- CS17 Making Camden a safer place
- CS18 Dealing with our waste and encouraging recycling

### Development Policies

- DP24 Securing high quality design
- DP25 Conserving Camden's heritage
- DP27 Basements and lightwells
- DP29 Improving access
- DP30 Shopfronts

1.7 It should be noted that the guidance covered in this section only forms part of the range of considerations that you should address when proposing new development. In addition to these specific design matters you should also consider wider issues such as cycle storage, residential space standards, wheelchair housing, designing in sustainability measures and impacts on neighbours. Further guidance on these, and other issues, is contained within the Local Development Framework documents and the Camden Planning Guidance.





## 2 Design excellence

### KEY MESSAGES

Camden is committed to excellence in design and schemes should consider:

- The context of a development and its surrounding area;
- The design of the building itself;
- The use of the building;
- The materials used; and
- Public spaces.

- 2.1 High quality design makes a significant contribution to the success of a development and the community in which it is located. Design of the built environment affects many things about the way we use spaces and interact with each other, comfort and enjoyment, safety and security and our sense of inclusion.
- 2.2 The purpose of this guidance is to promote design excellence and to outline the ways in which you can achieve high quality design within your development.
- 2.3 This guidance primarily relates to Core Strategy Policy CS14 Promoting high quality places and conserving our heritage and Development Policies DP24 Securing high quality design.



### When does this apply?

- 2.4 This guidance applies equally to all development, whether new build, converted, refurbished, extended and altered development. However, the implications for a proposal will vary greatly depending on the nature of the site, the proposed use, the scale of development, its interaction with surrounding sites, and existing buildings and structures on the site.

- 2.5 Other sections in this Camden Planning Guidance (CPG) relate to specific types of developments and relevant design matters, for example advertisements, signs and hoardings, designing safer environments, extensions, alterations and conversions, heritage and shopfronts.

### **General guidance on design**

- 2.6 Camden is committed to excellence in design. The borough contains many special and unique places, many of which are protected by conservation area status. In accordance with draft London Plan policies 7.1–7.7, Core Strategy policy CS14 requires development schemes to improve the quality of buildings, landscaping and public spaces and we will not approve design which is inappropriate to its context or fails to improve the character of an area.
- 2.7 We are working with our partners to promote design excellence and improve public buildings, landscaping and the street environment. We have established the Camden Design Initiative which seeks to encourage involvement, awareness and understanding of good design and this is promoted through the bi-annual Camden Design Awards which acknowledge high quality and innovative design. We are also a promoter of the national Civic Trust Awards which are awarded to buildings judged to have made a positive cultural, social or economic contribution to the local community.
- 2.8 In order to achieve high quality design in the borough we require applicants to consider buildings in terms of context, height, accessibility, orientation, siting, detailing and materials. These issues apply to all aspects of the development, including buildings and other structures (e.g. substations, refuse or cycle storage), outdoor spaces, landscaping and access points and should be considered at an early stage in the design of a development, as these elements are often difficult to change in later stages.



## **Context**

### 2.9 Good design should:

- positively enhance the character, history, archaeology and nature of existing buildings on the site and other buildings immediately adjacent and in the surrounding area, and any strategic or local views. This is particularly important in conservation areas;
- respect, and be sensitive to, natural and physical features, both on and off the site. Features to be considered include, but are not limited to: slope and topography, vegetation, biodiversity, habitats, waterways and drainage, wind, sunlight and shade, and local pollutant sources. Movement of earth to, from and around the site should be minimised to prevent flood risk, land instability and unnecessary transport of aggregates, especially by road; and
- consider connectivity to, from, around and through the site for people using all modes of transport, including pedestrians, cyclists, wheelchair users, those with visual impairments, people with pushchairs, and motorised vehicles.

## **Building design**

### 2.10 Good design should:

- ensure buildings do not significantly overshadow existing/proposed outdoor spaces (especially designated open spaces), amenity areas or existing or approved renewable energy facilities (such as solar panels). For further information, refer to CPG3 Sustainability Renewable energy (A shadowing exercise may be required for tall buildings or where they are near open spaces);
- consider the extent to which developments may overlook the windows or private garden area of another dwelling;
- consider views, both local and London wide, and particularly where the site is within a recognised strategic viewing corridor (as shown on the policy Proposals Map);
- consider the degree of openness of an area and of open spaces, including gardens including views in and out of these spaces
- contributions to the character of certain parts of the borough;
- provide visual interest for onlookers, from all aspects and distances. This will involve attention to be given to both form and detail;
- consider opportunities for overlooking of the street and, where appropriate, provide windows, doors and other 'active' features at ground floor; and
- incorporate external facilities such as renewable energy installations, access ramps, plant and machinery, waste storage facilities and shading devices into the design of the development. Careful consideration must be given to ensure that the facility does not harm the built environment.

### **Land use**

- 2.11 The use of a building should:
- take into account the proposed use, and the needs of the expected occupants of the buildings and other users of the site and development; and
  - provide clear indication of the use of the building. It is noted, however, that reuse of existing buildings, as well as the accommodation of possible future changes of use, can make this difficult.

### **Materials**

- 2.12 Materials should form an integral part of the design process and should relate to the character and appearance of the area, particularly in conservation areas or within the setting of listed buildings. The durability of materials and understanding of how they will weather should be taken into consideration. The quality of a well designed building can be easily reduced by the use of poor quality or an unsympathetic palette of materials. We will encourage re-used and recycled materials, however these should be laid to ensure a suitable level accessible surface is provided. Further guidance is contained within CPG3 Sustainability (Sustainable use of materials).

### **Tall buildings**

- 2.13 Tall buildings in Camden (i.e. those which are substantially taller than their neighbours and/or which significantly change the skyline) will be assessed against a range of design issues, including:
- how the building relates to its surroundings, both in terms of how the base of the building fits in with the streetscape, and how the top of a tall building affects the skyline;
  - the contribution a building makes to pedestrian permeability and improved public accessibility;
  - the relationship between the building and hills and views;
  - the degree to which the building overshadows public spaces, especially open spaces and watercourses; and
  - the historic context of the building's surroundings.
- 2.14 In addition to these design considerations tall buildings will be assessed against a range of other relevant policies concerning amenity, mixed use and sustainability. Reference should be made to this CPG (Heritage chapter), CPG3 Sustainability (Climate change adaptation chapter) and CPG6 Protecting and improving quality of life (Overlooking and privacy and Wind/microclimate chapters).
- 2.15 Where a proposal includes a development that creates a landmark or visual statement, particular care must be taken to ensure that the location is appropriate (such as a particular destination within a townscape, or a particular functional node) and that the development is sensitive to its wider context. This will be especially important where the

development is likely to impact upon heritage assets and their settings (including protected views).

- 2.16 Design should consider safety and access. Guidance on these issues is contained within this CPG (Designing safer environments chapter) and CPG4 Protecting and improving quality of life (Access for all chapter). Schemes over 90m should be referred to the Civil Aviation Authority.

### **Design of public space**

- 2.17 The design of public spaces, and the materials used, is very important. The size, layout and materials used in the spaces around buildings will influence how people use them, and help to create spaces that are welcoming, attractive, accessible, safe and useful. They can also contribute to other objectives such as reducing the impact of climate change (e.g. the use of trees and planters to reduce run-off and provide shading), biodiversity, local food production and Sustainable Urban Drainage Systems (SUDs), and provide useful amenity space. In Conservation Areas there may be particular traditional approaches to landscaping/boundary treatments that should be respected in new designs.
- 2.18 The spaces around new developments should be considered at the same time as the developments themselves and hard / soft landscaping and boundary treatments should be considered as part of wider cohesive design. The landscaping and trees chapter in this CPG, and individual Conservation Area Appraisals, provide further guidance on this issue.
- 2.19 Public art can be a catalyst for improved environmental quality by upgrading and animating public space and enhancing local character and identity through helping create a sense of place. The Council will therefore encourage the provision of art and decorative features as an integral part of public spaces, where they are appropriate to their location and enhance the character and environment.
- 2.20 It is important that public spaces and streets are maintained to a high standard and so, in line with the Local Implementation Plan, the Council will continue to undertake public space enhancement works through specifically targeted programmes. The Designing safer environments chapter in this CPG provides more detailed guidance on the incorporation of safety and security considerations in public spaces.

### **Design and access statements**

- 2.21 Design and Access Statements are documents that explain the design ideas and rationale behind a scheme. They should show that you have thought carefully about how everyone, including disabled people, older people and children, will be able to use the places you want to build.
- 2.22 Design and Access Statements should include a written description and justification of the planning application and sometimes photos, maps and drawings may be useful to further illustrate the points made. The length

and detail of a Design and Access Statement should be related to the related to the size and complexity of the scheme. A statement for a major development is likely to be much longer than one for a small scheme.

- 2.23 Design and Access Statements are required to accompany all planning, conservation and listed building applications, except in certain circumstances as set out on our website [www.camden.gov.uk/planning](http://www.camden.gov.uk/planning). Our website also provides a template for Design and Access Statements and lists the information that each statement should contain. Further guidance on Access Statements is provided in CPG4 Protecting and improving quality of life (Access for all chapter).

### Further information

General	By Design: Urban Design in the Planning System – Towards Better Practice, DETR/CABE, 2000 Design and Access Statements; how to read, write and use them, CABE, 2007
Tall Buildings	Guidance on tall buildings, English Heritage/CABE, 2007
Historic Environment	Understanding Place: conservation areas designation, appraisal and management (2011) Building in Context, English Heritage/CABE, 2002. Seeing History in the View (2011) Good Practice Advice 3- Settings and Views (2015)
Other	Royal Institute of Chartered Surveyors (RICS); and Royal Institute of British Architects (RIBA).



## 3 Heritage

### KEY MESSAGES

Camden has a rich architectural heritage and we have a responsibility to preserve, and where possible, enhance these areas and buildings.

- We will only permit development within conservation areas that preserves and enhances the character and appearance of the area
- Our conservation area statements, appraisals and management plans contain more information on all the conservation areas
- Most works to alter a listed building are likely to require listed building consent
- The significance of 'Non-Designated Heritage Assets' (NDHAs) will be taken into account in decision-making
- Historic buildings can and should address sustainability and accessibility

3.1 This section provides guidance on our identified heritage assets (which include conservation areas, listed buildings and registered parks and gardens), including what they are and the implications of their status and designation. This section also sets out details on how historic buildings can address sustainability.

3.2 This section sets out further guidance on how we will apply Core Strategy Policy CS14 Promoting high quality places and conserving our heritage and Development Policy DP25 Conserving Camden's Heritage.

### When does this apply?

3.3 This guidance applies to all applications which may affect any element of the historic environment and therefore may require planning permission, or conservation area or listed building consent.



## Conservation Areas

### What is a conservation area?

- 3.4 A conservation area is defined in the Planning (Listed Buildings and Conservation Areas) Act 1990 as an area of special architectural or historic interest, the character or appearance of which it is desirable to preserve and, where possible, enhance. PPS5 identifies conservation areas as “heritage assets” and requires that proposals in conservation areas are assessed for their impacts on their historic significance. There are 39 conservation areas in Camden, which vary greatly in appearance, size, character and style and these are identified on the LDF Proposals Map.



Figure 1. Conservation Areas

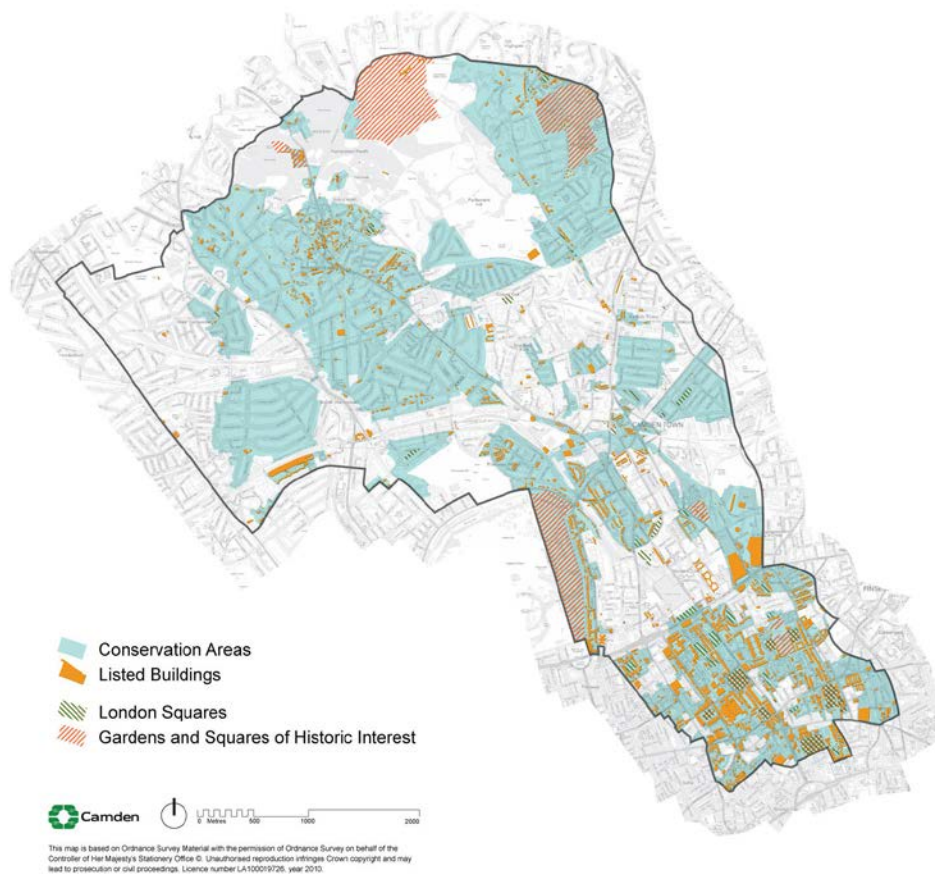

- 3.5 Conservation area designation is a way to recognise the importance of the quality of an area as a whole, as well as giving some protection to individual buildings within it. Conservation areas are not designated to stop all future development or change but to ensure that change is managed to conserve the historic significance of the area as a whole.
- 3.6 Conservation area designation is shown on the proposals map and further information on heritage is available on the 'Conservation and Design' section of the Council's website [www.camden.gov.uk](http://www.camden.gov.uk) and on English Heritage's website [www.english-heritage.org.uk](http://www.english-heritage.org.uk).

#### Effects of conservation area status

- 3.7 We will only permit development within conservation areas, and development affecting the setting of conservation areas, that preserves and enhances the character and appearance of the area (see Planning Policy Statement 5 (PPS5), policy HE8).
- 3.8 The Council has greater control over building work in conservation areas, including demolition, materials and detailed design. Planning permission may be required for alterations or extensions that would not normally need planning permission elsewhere, such as minor roof

alterations, dormer windows, renewable energy installations or installation of a satellite dish.

#### **Renewable energy technology**

Renewable energy technologies generate energy from natural resources such as sunlight, wind, rain and heat in the ground, which are naturally replenished.

### **Demolition in conservation areas**

- 3.9 Conservation Area Consent is required to demolish or substantially demolish a building over 115 cubic metres or a structure such as a wall over 1 metre high that adjoins a highway, or more than 2 metres high elsewhere. When determining your application we will follow the guidance in PPS5, Core Strategy policy CS14 and Development Policy DP24 as well as that in our conservation area statements, appraisals and management plans (see below). It is an offence to totally or substantially demolish a building or structure in a conservation area without first getting consent from us and we would not normally allow their demolition without substantial justification, in accordance with criteria set out in government guidance PPS5 – Planning for the Historic Environment.

### **Trees**

- 3.10 Planning legislation makes special provision for trees in conservation areas. Prior to pruning or felling a tree in a conservation area you must provide the Council six weeks notice in writing. All trees that contribute to the character and appearance of a conservation area should be retained and protected. For further information on trees, please see Landscape Design and Trees chapter in this CPG.



### **Article 4 directions**

- 3.11 A range of minor changes can be made to buildings without the need to apply for planning permission as these have a general permission through planning legislation. These changes are known as permitted development. However, the character of a conservation area depends on the presence of specific original details and where these are lost the historic interest and attractive character of the area deteriorates.

- 3.12 In these situations we can issue an Article 4 direction through Article 4 of the Town and Country Planning (General Permitted Development) Order 1995 (as amended). This removes permitted development rights and means a planning application has to be made for minor works that usually do not need one.
- 3.13 Further information on Article 4 directions, including where they apply in Camden is available on the 'Advice and help with planning applications' section of the Council's website [www.camden.gov.uk](http://www.camden.gov.uk) and English Heritage has published Guidance on making Article 4 Directions, available at [www.english-heritage.org.uk/publications/guidance-on-making-article-4-directions/](http://www.english-heritage.org.uk/publications/guidance-on-making-article-4-directions/)

### **Conservation area statements, appraisals and management plans**

- 3.14 We have published a series of conservation area statements, appraisals and management plans that set out our approach to preserving and enhancing the historic significance of each individual conservation area. Many of these conservation area statements are available for download on our website.
- 3.15 Conservation area statements, appraisals and management plans help guide the design of development in conservation areas and we take these into account when assessing planning applications.
- 3.16 Each conservation area statement, appraisal or management plan contains the following:
- A summary of the location and the historical development of an area;
  - A description of its character;
  - An outline of the key issues and development pressures that are currently of concern;
  - The key policy framework for that particular conservation area, and specific guidance for it;
  - An identification of heritage assets and elements of the wider historic environment which give an area its historic significance; and
  - An identification of sites and features that have a negative impact on the conservation area, or where an opportunity exists for enhancement of the area by redevelopment of a building or site.



## Listed Buildings

### What is a listed building?

- 3.17 A listed building is defined in the Planning (Listed Buildings and Conservation Areas) Act 1990 as a structure or building of special architectural or historic interest. These are included on the Statutory List of Buildings of Architectural or Historic Interest managed by English Heritage. Listed buildings are identified as heritage assets within the LDF and the Council is required to assess the impact that proposals to a listed building, or within their setting, may have on the historic significance of the building.
- 3.18 Listed buildings are graded according to their relative importance as either Grade I, Grade II\* or Grade II. Grades I and II\* are considered of outstanding architectural or historic interest and are of particularly great importance to the nation's heritage. The majority of listed buildings (about 94% nationally) are Grade II. However, the statutory controls on alterations apply equally to all listed buildings irrespective of their grade and cover the interior as well as the exterior and any object or structure fixed to or within their curtilage.

#### **Listing description**

The listing description contains details of a listed building's address, history, appearance and significance. These help to identify what it is about the building that gives it its special historic interest.

- 3.19 Further information on listed buildings in Camden is available on our website [www.camden.gov.uk](http://www.camden.gov.uk)

### How can I alter a listed building?

- 3.20 Most works to alter a listed building are likely to require listed building consent and this is assessed on a case by case basis, taking into



account the individual features of a building, its historic significance and the cumulative impact of small alterations. The listing description is not intended to be exhaustive and the absence of any particular feature in the description does not imply that it is not of significance, or that it can be removed or altered without consent. Listed status also extends to any object or structure fixed to the listed building, and any object or structure within its curtilage which forms part of the land. You should contact the Council at the earliest opportunity to discuss proposals and to establish whether listed building consent is required.

- 3.21 Some 'like for like' repairs and maintenance do not require listed building consent. However, where these would involve the removal of historic materials or architectural features, or would have an impact on the special architectural or historic interest of the building, consent will be required. If in doubt applicants should contact the Council for advice.
- 3.22 In assessing applications for listed building consent we have a statutory requirement to have special regard to the desirability of preserving the building or its setting or any features of special architectural or historic interest which it possesses. We will consider the impact of proposals on the historic significance of the building, including its features, such as:
- original and historic materials and architectural features;
  - original layout of rooms;
  - structural integrity; and
  - character and appearance.
- 3.23 We will expect original or historic features to be retained and repairs to be in matching material. Proposals should seek to respond to the special historic and architectural constraints of the listed building, rather than significantly change them.
- 3.24 Applications for listed building consent should be fully justified and should demonstrate how proposals would affect the significance of a listed building and why the works or changes are desirable or necessary. In addition to listed building consent, some proposals may also require planning permission. These applications should be submitted together and will be assessed concurrently.
- 3.25 It is a criminal offence to undertake unauthorised works to a listed building, even if you are not aware the building is listed, and could result in prosecution and fine or imprisonment (or both).
- 3.26 Some works that are required in order to comply with the Building Regulations (e.g. inclusive access, energy efficiency) may have an impact on the historic significance of a listed building and will require listed building consent.

### **Inclusive access to listed buildings**

- 3.27 It is important that everyone should have dignified and easy access to and within historic buildings, regardless of their level of mobility. With

sensitive design, listed buildings can be made more accessible, while still preserving and enhancing the character of the building.

- 3.28 Further guidance is available in CPG4 Protecting and improving quality of life (Access for all chapter) and in the English Heritage publication “Easy Access to Historic Buildings” [www.english-heritage.org.uk](http://www.english-heritage.org.uk)



### **Non-Designated Heritage Assets (NDHAs)**

- 3.29 Camden has a high quality historic environment which includes listed buildings, conservation areas, parks and gardens recognised for their important architectural or historic interest and many formal squares protected under the London Squares Preservation Act 1931. The Borough also has many attractive, historic, locally significant buildings and features which contribute to the distinctiveness of local areas, but which are not formally designated. The National Planning Policy Framework (NPPF) identifies these features as non-designated heritage assets (NDHAs).
- 3.30 Buildings make up the majority of these NDHAs, but street furniture such as civil parish boundary markers, post boxes or cobbles, and historic natural landscape features such as green spaces, gardens and parks can also be considered NDHAs. Often it is the commonplace things around us that give character to an area, but they may be overlooked because of their familiarity. Pubs, shops, places of meeting, places of worship, benches, statues, whether subtle or idiosyncratic, all contribute to the particular character of a place. They add depth of meaning and make a place special for local people, by acting as a visual marker for the local history, traditions, stories and memories that survive into the present day.

### Identification of NDHAs

- 3.31 Non-designated heritage assets may either be identified as part of the planning process (e.g. pre-application process) or on Camden's Local List.

#### Camden's Local List

- 3.32 Camden's Local List identifies non-designated heritage assets within the borough, providing information about their architectural, historic, townscape and / or social significance. It acts as a valuable resource to residents, developers and other interested parties alike, helping to ensure that the significance of any asset deemed a non-designated heritage asset is carefully considered by the Council in decision making.
- 3.33 In order to ensure that the identification of non-designated heritage assets is consistent and that their significance is properly considered, the selection criteria, set out below, were developed and adopted in November 2012.

To be considered for inclusion on the Local List nominations should satisfy a minimum of two criteria with at least one of them being either criteria 1 or 2.

**CRITERIA 1 - ARCHITECTURAL SIGNIFICANCE** this includes assets that;

- a) demonstrate distinctive artistic, craftsmanship, design or landscaping qualities of merit (e.g. form, layout, proportions, materials, decoration);

and/or

- b) are attributed to a locally known, architect, designer, gardener or craftsman and demonstrates quality of design, execution, and innovation.

and/or

- c) exemplify a rare type or function which survives in anything like its original condition and form.

**CRITERIA 2 - HISTORICAL SIGNIFICANCE** this includes assets that

- a) demonstrate rare evidence of a particular phase or period of the area's history;

and/or

- b) are associated with a locally important historic person, family or group;

and/or

- c) are associated with a notable local historic event or movement.

Nominations under this criteria should retain physical attributes which are of key importance to their historical significance.

**CRITERIA 3 - TOWNSCAPE SIGNIFICANCE** this includes assets which play a key part in supporting the distinctive character of the local neighbourhood either as a landmark, for their aesthetic qualities, through promoting collective identity or group value.

**CRITERIA 4 - SOCIAL SIGNIFICANCE** this includes assets that

a) are associated with distinctive communal, commemorative, symbolic or spiritual significance;

and/or

b) are associated with locally distinctive cultural heritage, such as art, literature, music or film;

which have support from and are valued by a wider community or society. Nominations under this criteria should retain physical attributes which are of key importance to their social significance.

- 3.34 The Local List can accessed online via the Local List webpage [www.camden.gov.uk/locallist](http://www.camden.gov.uk/locallist)
- 3.35 The Local List is an evolving document that will develop over time, e.g. as new non-designated heritage assets are identified, or new information requires an existing item on the Local List to be amended. A revised Local List will be published online annually to take account of any necessary amendments, and may also be periodically reviewed and updated.

#### **Implications of being a non-designated heritage asset (NDHA)**

- 3.36 Unlike proposals that will affect designated assets (such as statutorily Listed Buildings) being identified as a non-designated heritage asset (either identified on the Local List or as part of the planning process) does not automatically affect your permitted development rights.

However if planning permission is required for any proposal that would either directly or indirectly affect the significance of a non-designated heritage asset (either on the Local List or not) then the Council will treat the significance of that asset as a material consideration when determining the application.

**OFFICERS** - will make a balanced judgment having regard to the scale of any harm or loss and the significance of the asset/s affected. They will take account of:

- the desirability of sustaining and enhancing the significance of any non-designated heritage asset/s and putting them to viable uses consistent with their conservation;
- the positive contribution that the conservation of heritage assets can make to sustainable communities including their economic vitality;



- the desirability of new development that affects non-designated heritage assets to preserve and enhance local character and distinctiveness.

**APPLICANTS** - will need to show how the significance of the asset, including any contribution made by their setting, has been taken into consideration in the design of the proposed works. The level of detail required will be proportionate to the asset/s importance and no more than is sufficient to understand the potential impact of the proposal on the significance of the asset/s affected;

**PLEASE NOTE: There is a presumption in favour of retaining NDHAs which are either identified as part of planning process or on the Local List.**

- 3.37 The use of Article 4 Direction/s to remove specific permitted development rights from buildings/features identified as non-designated heritage assets will be considered where it is deemed necessary and appropriate.

#### **Non-designated heritage assets and Conservation Areas**

- 3.38 The identification of NDHAs and the process of local heritage listing aims to focus attention on buildings/features which are considered to be locally significant but whose architectural and historic value is not formally recognised (and therefore do not currently benefit from protection as part of the planning process).
- 3.39 For this reason the focus of Camden's Local List is largely with buildings/features located outside designated conservation areas and does not include buildings that are identified as making a positive contribution to the character of a conservation area. However there may be exceptional circumstances where a building, landscape or feature is located within a conservation area but can still be considered for inclusion on the local list.
- 3.40 For information on conservation areas please refer to the section 3.4-3.16 in this chapter and our conservation area appraisals which are available on our website.



### **How can historic buildings address sustainability?**

- 3.41 We recognise the role that the historic environment can play in reducing the impact of climate change. For example, reusing existing buildings could avoid the material and energy cost of new development. There are many ways to improve the efficiency and environmental impact of historic buildings, for example improving insulation, draught-proofing and integrating new energy-saving and renewable-energy technologies. We will seek to balance achieving higher environmental standards with protecting Camden's unique built environment (in accordance with LDF Core Strategy policies CS13 Tackling climate change through promoting higher environmental standards and CS14 Promoting high quality places and conserving our heritage) and PPS5 policy HE.1.
- 3.42 More detailed guidance on how to modify buildings without compromising their significance is contained within CPG3 Sustainability (Energy efficiency: new buildings, Energy efficiency: existing buildings, Renewable energy, Climate change adaptation, Water efficiency, Flooding and Sustainable use of materials). For further information see the links at the end of this chapter.

### **Planning obligations relating to heritage assets**

- 3.43 Many of the potential impacts of development on historic buildings and in archaeological priority and conservation areas can be covered through design and by conditions on the planning permission, for example the need to carry out surveys or the storage and restoration of artefacts. Some objectives for building and area conservation or archaeology are unlikely to be satisfactorily controlled by a condition or in such cases and where impacts are off-site, or involve a particularly sensitive or complex programme of works, involving phasing, the Council may require implementation of these measures through a Section 106 Agreement.

## Further information

National Planning Policy Framework (NPPF)	<p>The Government's national policies on the historic environment are set out in:</p> <ul style="list-style-type: none"> <li>National Planning Policy Framework (NPPF) Chapter 12, Conserving and enhancing the historic environment – DCLG, 2012 <a href="https://www.gov.uk/government/publications/national-planning-policy-framework--2">https://www.gov.uk/government/publications/national-planning-policy-framework--2</a></li> </ul> <p>If you want guidance implement this national policy, it is provided in:</p> <ul style="list-style-type: none"> <li>Planning Practice Guidance, guidance category - Conserving and enhancing the historic environment <a href="http://planningguidance.planningportal.gov.uk/blog/guidance/conserving-and-enhancing-the-historic-environment/">http://planningguidance.planningportal.gov.uk/blog/guidance/conserving-and-enhancing-the-historic-environment/</a></li> <li>PPS 5 Practice Guidance for the Historic Environment is still extant whilst the government prepares further guidance in the form of Technical Advice Notes, due out for consultation summer 2014. <a href="http://www.english-heritage.org.uk/professional/advice/government-planning-policy/pps-practice-guide/">http://www.english-heritage.org.uk/professional/advice/government-planning-policy/pps-practice-guide/</a></li> </ul>
English Heritage	<p><a href="http://www.englishheritage.org.uk">www.englishheritage.org.uk</a></p> <p>Guidance on heritage assets:</p> <ul style="list-style-type: none"> <li>Guidance on Conservation Area Appraisals, 2006 – English Heritage;</li> <li>Guidance on Management of Conservation Areas, 2006 – English Heritage;</li> <li>Climate Change and the Historic Environment (2008); and</li> <li>Heritage at Risk Register - English Heritage <a href="http://risk.english-heritage.org.uk/2010.aspx">http://risk.english-heritage.org.uk/2010.aspx</a></li> <li>Good Practice Guide to Local Heritage Listing (2012) <a href="http://www.english-heritage.org.uk/caring/listing/local/local-designations/local-list/">http://www.english-heritage.org.uk/caring/listing/local/local-designations/local-list/</a></li> </ul> <p>Guidance on sustainability measures in heritage buildings:</p> <ul style="list-style-type: none"> <li>Energy Conservation in Traditional Buildings</li> <li>Climate Change and the Historic Environment</li> </ul> <p>There is also an online resource dedicated to climate change and the historic environment, available at:</p> <ul style="list-style-type: none"> <li><a href="http://www.englishheritage.org.uk/climatechangeandyourhome">www.englishheritage.org.uk/climatechangeandyourhome</a></li> </ul>
Energy Saving Trust	<p><a href="http://www.est.org.uk">www.est.org.uk</a></p>



## 4 Extensions, alterations and conservatories

### KEY MESSAGES

- Alterations should always take into account the character and design of the property and its surroundings.
- Windows, doors and materials should complement the existing building.
- Rear extensions should be secondary to the building being extended.
- You can make certain types of minor alterations without planning permission (see below) external alterations.

4.1 This guidance provides advice to those seeking to alter or extend a residential property, including the erection of conservatories. The principles of this guidance also apply to extensions and alterations to other types of property. It expects high quality design that respects and enhances the character and appearance of a property and its surroundings, and also covers matters such as outlook, privacy and overlooking.

4.2 This guidance relates to Core Strategy Policy CS14 Promoting high quality places and conserving our heritage and Development Policies DP24 Securing high quality design.

### When does this apply?

4.3 This guidance applies to all proposals for alterations and extensions to residential properties, although some aspects will be relevant to alterations and extensions to other types of buildings.

4.4 You can make certain types of minor changes to your property without needing to apply for planning permission. These are called "permitted development rights", and further details can be found on the planning portal website [www.planningportal.gov.uk](http://www.planningportal.gov.uk) or by contacting the Council. In some conservation areas, Article 4 directions have been introduced which have removed certain permitted development rights. Details of Article 4 Directions, including where they apply in Camden can be found in the Conservation and Urban Design section of our website [www.camden.gov.uk](http://www.camden.gov.uk).

4.5 In addition to this guidance, you should also make reference to chapters on Heritage, Design excellence and Roofs, Terraces and balconies, in this CPG. If your property is situated within a conservation area then you should also refer to the relevant Conservation Area Statement, Appraisal or Management Plan, which sets out detailed guidelines for development in a particular area. Many of these are available on our website.

## Guidance for all extensions and alterations

### External alterations

- 4.6 The good practice principles set out below and the general design considerations for residential façades shown in Figure 1 – ‘Alterations to Residential Façades’ should be followed when undertaking external alterations. A façade is the front or face of a building.

### Good practice principles for external alterations

- 4.7 Alterations should always take into account the character and design of the property and its surroundings. A harmonious contrast with the existing property and surroundings may be appropriate for some new work to distinguish it from the existing building; in other cases closely matching materials and design details are more appropriate so as to ensure the new work blends with the old.

### Windows

- Where it is necessary to alter or replace windows that are original or in the style of the originals, they should be replaced like with like wherever possible in order to preserve the character of the property and the surrounding area. New windows should match the originals as closely as possible in terms of type, glazing patterns and proportions (including the shape, size and placement of glazing bars), opening method, materials and finishes, detailing and the overall size of the window opening.
- Where timber is the traditional window material, replacements should also be in timber frames. uPVC windows are not acceptable both aesthetically and for environmental reasons, including their relatively short lifespan and inability to biodegrade. Similarly, where steel is the traditional window material, steel replacements will be sought wherever possible, see also CPG3 Sustainability (Sustainable use of materials chapter), which gives guidance on the use of sustainable materials).
- Reference should be made to the Building Research Establishment’s (BRE) Green Guide to Specification when sourcing replacement window frames.
- Where the original glazing bars are highly detailed and intricate, or contain stained glass or leaded panes these should be retained and repaired. See also the Camden leaflet *A Guide to Windows (2006)*, which is available on our website, for advice on secondary glazing and other ways to improve energy efficiency while retaining attractive original features.
- Where windows are replaced they should have the lowest ‘U-value’ feasible.
- Listed building consent will be required for replacement windows, secondary glazing and double-glazing in listed buildings.
- In conservation areas original single-glazed windows often contribute to the character and appearance of the area, and should be retained

and upgraded. There may however be some instances where double-glazing can be installed in a design that matches the original, for instance sash windows or casements with large individual pane sizes, or in secondary glazing. In such cases, the window frame and glazing bars of the replacement windows should match the existing.

- Further guidance on window alterations and the effect that this can have on energy efficiency and protecting heritage assets can be found on English Heritage's 'Climate Change and your Home' website: [www.climatechangeandyourhome.org.uk](http://www.climatechangeandyourhome.org.uk)

### Doors

- Where you are looking to replace doors their design should match the dimensions, proportions, joinery details, panelling and glazing of the original. Where timber replacement doors are proposed the timber should be sustainably sourced.
- Characteristic doorway features, such as porches, such be retained where they make a positive contribution to the character of groups of buildings.

### Materials

- Wherever possible you should use materials that complement the colour and texture of the materials in the existing building, see also CPG3 Sustainability (Sustainable use of materials chapter). In historic areas traditional materials such as brick, stone, timber and render will usually be the most appropriate complement to the existing historic fabric; modern materials such as steel and glass may be appropriate but should be used sensitively and not dominate the existing property.
- Materials for alterations should weather well, so their ageing process contributes positively to the character of the building, and the site's wider context.
- Original surface finishes should be retained or replicated wherever possible, as they are usually central to the architectural design / character treatment of a building. These may cover the entire building or façade (such as stucco facing), the roof elements (such as roof tiles and roof ridges), highlight specific features (such as windows or doors) or act as decorative elements (such as ironwork or terracotta panels).
- When repairing existing wall finishes, the composition of the original material (such as plaster, stucco or render) should be determined, the defective area cut out and a replacement material of identical chemical composition applied and properly bonded. Concrete repairs are generally non-original and unsympathetic to historic buildings, and can damage bricks, and should be replaced with a more traditional lime-based finish.
- The insulating quality of materials should be considered, along with their embodied energy (the energy used in manufacture) and the potential for re-use and recycling.



- Alterations or repairs to brickwork or stonework should match the original in all respects while satisfying the needs of durability and maintenance. This should include matching the original bond, mortar colour and texture. Retention of any existing pointing is encouraged wherever possible.
- Samples of brick type and mortar colour will normally be required to be submitted to the Council as part of any application.
- Painting, rendering or cladding of brickwork will normally be resisted, as it is often unsightly and can damage the appearance of a building by obscuring the texture and original colour of the façade. Painting, rendering or cladding may also trap moisture, which can cause major damp problems in the masonry.

### External pipework

- Original external pipework and guttering should be repaired or reinstated in a like-for-like manner, where possible. In the case of historic buildings, cast iron replicas of original pipework are preferable to uPVC pipes. New pipework should be restricted to the side and rear elevations of buildings to avoid spoiling the appearance of the principal façade and should be grouped together and located in a discrete position.

### Scale

- 4.8 Extensions should be subordinate to the original building in terms of scale and situation unless the specific circumstances of the site, such as the context of the property or its particular design, would enable an exception to this approach. More detailed guidance on design considerations is contained within CPG1 Design (Design excellence chapter).

**Figure 2. Alterations to residential facades**

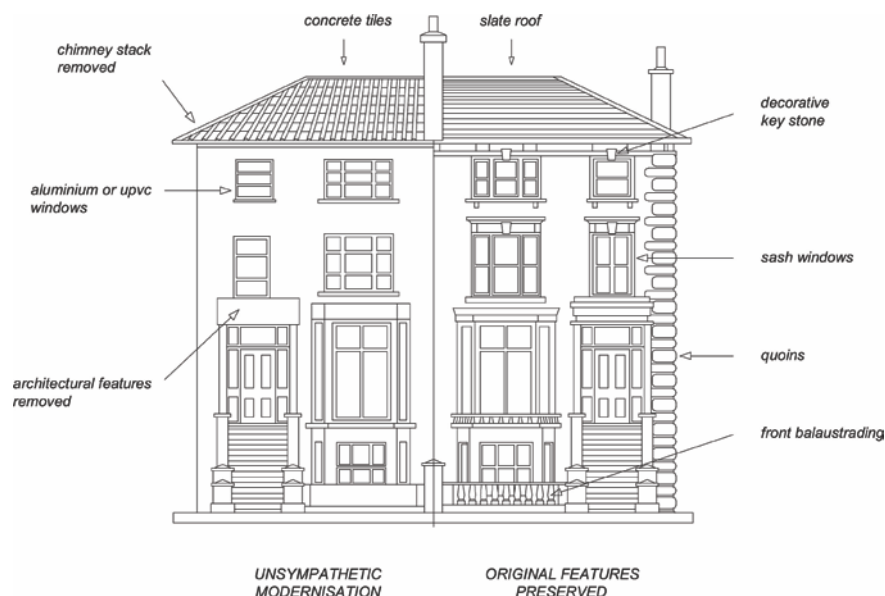



## Rear extensions

- 4.9 A rear extension is often the most appropriate way to extend a house or property. However, rear extensions that are insensitively or inappropriately designed can spoil the appearance of a property or group of properties and harm the amenity of neighbouring properties, for example in terms of outlook and access to daylight and sunlight.

### General principles

- 4.10 Rear extensions should be designed to:
- be secondary to the building being extended, in terms of location, form, scale, proportions, dimensions and detailing;
  - respect and preserve the original design and proportions of the building, including its architectural period and style;
  - respect and preserve existing architectural features, such as projecting bays, decorative balconies or chimney stacks;
  - respect and preserve the historic pattern and established townscape of the surrounding area, including the ratio of built to unbuilt space;
  - not cause a loss of amenity to adjacent properties with regard to sunlight, daylight, outlook, overshadowing, light pollution/spillage, privacy/overlooking, and sense of enclosure;
  - allow for the retention of a reasonable sized garden; and
  - retain the open character of existing natural landscaping and garden amenity, including that of neighbouring properties, proportionate to that of the surrounding area.
- 4.11 Materials should be chosen that are sympathetic to the existing building wherever possible (see also CPG3 Sustainability on Sustainable use of materials).

### Height of rear extensions

- 4.12 In order for new extensions to be subordinate to the original building, their heights should respect the existing pattern of rear extensions, where they exist. Ground floor extensions are generally considered preferable to those at higher levels. The maximum acceptable height of an extension should be determined in relation to the points outlined in paragraph 4.10 above. In cases where a higher extension is appropriate, a smaller footprint will generally be preferable to compensate for any increase in visual mass and bulk, overshadowing and overlooking that would be caused by the additional height.
- 4.13 In most cases, extensions that are higher than one full storey below roof eaves/parapet level, or that rise above the general height of neighbouring projections and nearby extensions, will be strongly discouraged.

### **Width of rear extensions**

- 4.14 The width of rear extensions should be designed so that they are not visible from the street and should respect the rhythm of existing rear extensions.
- 4.15 In addition, the rear of some buildings may be architecturally distinguished, either forming a harmonious composition, or visually contributing to the townscape. The Council will seek to preserve these where appropriate. Some of the Borough's important rear elevations are identified in conservation area statements, appraisals and management plans.

### **Side extensions**

- 4.16 Certain building forms may lend themselves to side extensions. Such extensions should be designed in accordance with the general considerations set out above in paragraph 4.10. Side extensions should also:
- be no taller than the porch; and
  - set back from the main building.
- 4.17 In many streets in the north of the Borough houses have mature rear gardens that can often be seen through gaps between buildings, softening the urban scene and providing visual interest. The infilling of gaps will not be considered acceptable where:
- significant views or gaps are compromised or blocked;
  - the established front building line is compromised;
  - the architectural symmetry or integrity of a composition is impaired;
  - the original architectural features on a side wall are obscured; or
  - access to the rear of a property is lost.
- 4.18 Where a property is located in a conservation area, reference should be made to the relevant conservation area statements, appraisals and management plans, which often identify important gaps and vistas where infilling would be inappropriate.

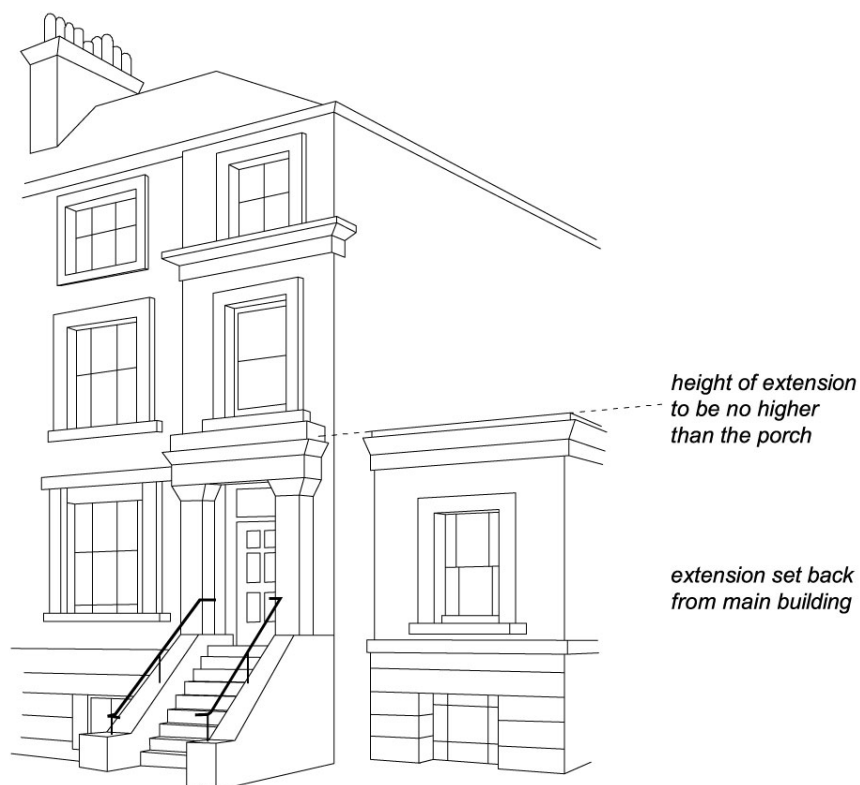
**Figure 3. Side extensions**

## Conservatories

4.19 Conservatories should normally:

- be located adjacent to the side and rear elevations of the building;
- be subordinate to the building being extended in terms of height, mass, bulk, plan form and detailing;
- respect and preserve existing architectural features, e.g. brick arches, windows etc;
- be located at ground or basement level. Only in exceptional circumstances will conservatories be allowed on upper levels;
- not extend the full width of a building. If a conservatory fills a gap beside a solid extension, it must be set back from the building line of the solid extension; and
- be of a high quality in both materials and design.

4.20 Conservatories should not overlook or cause light pollution to neighbouring properties, including to those in flats above. In order to minimise overlooking, opaque lightweight materials such as obscured glass may be necessary on façades abutting neighbouring properties. Also, in order to minimise light pollution, solid lightweight materials, one-way glass or obscured glass may be required.

- 4.21 Further guidance is contained within CPG4 Protecting and improving quality of life (Light Pollution chapter).

#### **Development in rear gardens and other open land**

- 4.22 The construction of garden buildings, including sheds, stand-alone green houses and other structures in rear gardens and other undeveloped areas, can often have a significant impact upon the amenity, biodiversity and character of an area. They may detract from the generally soft and green nature of gardens and other open space, contributing to the loss of amenity for existing and future residents of the property.
- 4.23 Large garden buildings may also affect the amenity value of neighbours' gardens, and if used for purposes other than storage or gardening, may intensify the use of garden spaces.
- 4.24 Development in rear gardens should:
- ensure the siting, location, scale and design of the proposed development has a minimal visual impact on, and is visually subordinate to, the host garden
  - not detract from the open character and garden amenity of the neighbouring gardens and the wider surrounding area
  - use suitable soft landscaping to reduce the impact of the proposed development
  - ensure building heights will retain visibility over garden walls and fences
  - use materials which complement the host property and the overall character of the surrounding area. The construction method should minimise any impact on trees (also see Landscape design and trees chapter in this CPG), or adjacent structures
  - address any impacts of extensions and alterations upon water run-off and groundwater flows, both independently or cumulatively with other extensions, and demonstrate that the impact of the new development on water run-off and groundwater flows will be negated by the measures proposed. Reference should be made to CPG3 Sustainability (Flooding chapter).
- 4.25 Pockets of privately owned land make important contributions to the character of certain parts of the borough, both in established neighbourhoods and areas of new development, creating village greens, informal verges, set backs for established structures or settings for listed buildings. Building on such areas will generally be discouraged.
- 4.26 Where any type of development, either in a rear garden or on private land that forms part of a public space, may be appropriate in principle, a full assessment should be made prior to the commencement of the development to avoid any potential impact upon trees or other vegetation in the surrounding area. This assessment may be required as part of an application for planning permission.

### **Further information**

- 4.27 The following professional bodies provide further guidance and advice on buildings and design matters:
- Royal Institute of Chartered Surveyors (RICS); and
  - Royal Institute of British Architects (RIBA).



## 5 Roofs, terraces and balconies

### KEY MESSAGES

Roof extensions fall into two categories:

- Alterations to the overall roof form; or
- Smaller alterations within the existing roof form, such as balconies and terraces.

When proposing roof alterations and extensions, the main considerations should be:

- The scale and visual prominence;
- The effect on the established townscape and architectural style;
- The effect on neighbouring properties

- 5.1 This guidance provides advice on roof alterations and extensions and on proposals for balconies and terraces. The Council will seek to ensure that roof alterations are sympathetic and do not harm the character and appearance of buildings or the wider townscape in the borough.
- 5.2 This guidance replates primarily to Development Policies DP24 Securing high quality design and DP25 Conserving Camden's Heritage.

### When does this apply?

- 5.3 This guidance applies to all planning applications involving roof alterations, roof extensions, balconies and terraces, and is particularly relevant to residential properties.
- 5.4 For properties in conservation areas, reference should also be made to the relevant conservation area statements, appraisals and management plans. These describe the area and its special character and contain specific area-based advice.
- 5.5 Where buildings are listed, reference should also be made to planning guidance on Heritage.

### Roof alterations and extensions – general principles

- 5.6 Proposals to alter and extend roofs fall into two categories: those that are accommodated within the existing roof form, such as dormer windows and roof lights, and those which alter the overall roof form, such as the construction of mansard roofs.
- 5.7 Additional storeys and roof alterations are likely to be **acceptable** where:
- There is an established form of roof addition or alteration to a terrace or group of similar buildings and where continuing the pattern of development would help to re-unite a group of buildings and townscape;

- Alterations are architecturally sympathetic to the age and character of the building and retain the overall integrity of the roof form;
- There are a variety of additions or alterations to roofs which create an established pattern and where further development of a similar form would not cause additional harm.

5.8 A roof alteration or addition is likely to be **unacceptable** in the following circumstances where there is likely to be an adverse affect on the skyline, the appearance of the building or the surrounding street scene:

- There is an unbroken run of valley roofs;
- Complete terraces or groups of buildings have a roof line that is largely unimpaired by alterations or extensions, even when a proposal involves adding to the whole terrace or group as a co-ordinated design;
- Buildings or terraces which already have an additional storey or mansard;
- Buildings already higher than neighbouring properties where an additional storey would add significantly to the bulk or unbalance the architectural composition;
- Buildings or terraces which have a roof line that is exposed to important London-wide and local views from public spaces;
- Buildings whose roof construction or form are unsuitable for roof additions such as shallow pitched roofs with eaves;
- The building is designed as a complete composition where its architectural style would be undermined by any addition at roof level;
- Buildings are part of a group where differing heights add visual interest and where a roof extension would detract from this variety of form;
- Where the scale and proportions of the building would be overwhelmed by additional extension.

5.9 Materials, such as clay tiles, slate, lead or copper, that visually blend with existing materials, are preferred for roof alterations and repairs. Where roofs are being refurbished, original materials such as keyhole ridge tiles or decorative chimney stacks and chimney pots should be reused. Replacement by inappropriate substitutes erodes the character and appearance of buildings and areas.

5.10 Where the principle of an additional storey is acceptable, the more specific guidance set out below will apply. This advice is supplemented by more specific area-based advice as set out in the Council's conservation area statements, appraisals and management plans which set out our approach to preserving and enhancing such areas. Many of these appraisals and management plans are available for download on our website, or are available as hard copies from our Planning reception.



## Roof dormers

- 5.11 Alterations to, or the addition of, roof dormers should be sensitive changes which maintain the overall structure of the existing roof form. Proposals that achieve this will be generally considered acceptable, providing that the following circumstances are met:
- a) The pitch of the existing roof is sufficient to allow adequate habitable space without the creation of disproportionately large dormers or raising the roof ridge. Dormers should not be introduced to shallow-pitched roofs.
  - b) Dormers should not be introduced where they cut through the roof ridge or the sloped edge of a hipped roof. They should also be sufficiently below the ridge of the roof in order to avoid projecting into the roofline when viewed from a distance. Usually a 500mm gap is required between the dormer and the ridge or hip to maintain this separation (see Figure 4). Full-length dormers, on both the front and rear of the property, will be discouraged to minimise the prominence of these structures.
  - c) Dormers should not be introduced where they interrupt an unbroken roofscape.
  - d) In number, form, scale and pane size, the dormer and window should relate to the façade below and the surface area of the roof. They should appear as separate small projections on the roof surface. They should generally be aligned with windows on the lower floors and be of a size that is clearly subordinate to the windows below. In some very narrow frontage houses, a single dormer placed centrally may be preferable (see Figure 4). It is important to ensure the dormer sides (“cheeks”) are no wider than the structure requires as this can give an overly dominant appearance. Deep fascias and eaves gutters should be avoided.
  - e) Where buildings have a parapet the lower edge of the dormer should be located below the parapet line (see Figure 4).
  - f) Materials should complement the main building and the wider townscape and the use of traditional materials such as timber, lead and hanging tiles are preferred.

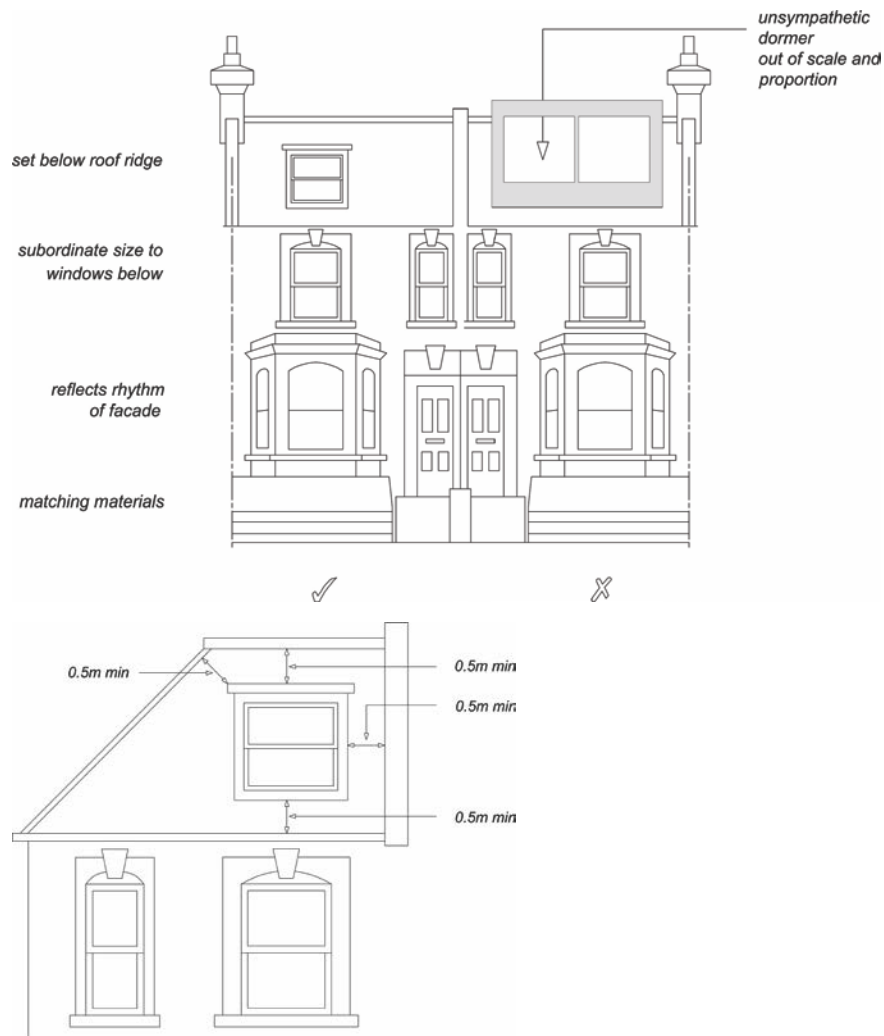
**Figure 4. Dormer windows**

5.12 See CPG2 Housing (Residential development standards chapter) for further information, particularly the section on ceiling heights.

5.13 The presence of unsuitably designed new or altered dormers on neighbouring properties will not serve as a precedent for further development of the same kind.

### **Mansard Roofs**

5.14 Mansard roofs are a traditional means of terminating a building without adding a highly visible roof. This form is acceptable where it is the established roof form in a group of buildings or townscape.

Figure 5. Mansard Roofs

TRUE MANSARD

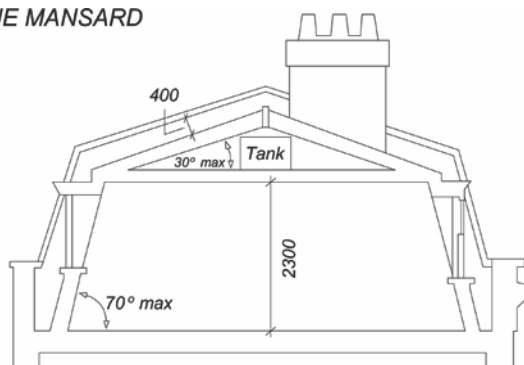

FLAT TOP MANSARD

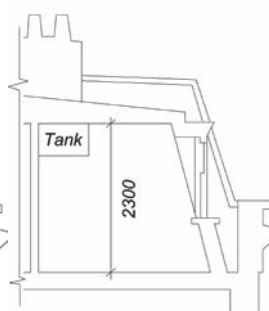
**True Mansard**

Lower slope is at a steeper angle than the upper, and the upper slope is visible

**Flat topped Mansard**

Upper slope of a pitch below 5° or totally flat

- 5.15 Mansard roofs are often the most appropriate form of extension for a Georgian or Victorian dwelling with a raised parapet wall and low roof structure behind. Mansard roofs should not exceed the height stated in Figure 5 so as to avoid excessive additional height to the host building. They are often a historically appropriate solution for traditional townscapes. It should be noted that other forms of roof extensions may also be appropriate in situations where there is a strong continuous parapet and the extension is sufficiently set back or where they would match other existing sympathetic roof extension already in the terrace.

**Parapet wall**

A low wall or railing that is built along the edge of a roof, balcony or terrace for protection purposes.

**Cornice**

The topmost architectural element of a building, projecting forward from the main walls, originally used as a means of directing rainwater away from the building's walls.

- 5.16 The three main aspects to consider when designing a mansard roof extension are its:
- pitches and profile;
  - external covering; and
  - windows.
- 5.17 The lower slope (usually 60-70°) should rise from behind and not on top of the parapet wall, separated from the wall by a substantial gutter. Original cornice, parapet and railing details should be retained and where deteriorated or lost, should be incorporated into the design of new roof extensions. Visible chimney stacks should be retained and increased in height, where necessary. Only party walls with their chimney stacks and windows should break the plane of the roof slope, and should be accommodated in a sensitive way and be hidden as far

as is possible. (See also guidance on dormer windows and roof lights). Dormer windows or roof lights should be confined to the lower slope.

- 5.18 Roofing materials should be of the highest quality because of their significant visual impact on the appearance of a building and townscape and the need to be weather-tight. Natural slate is the most common covering and this should be laid with a traditional overlap pattern. Artificial slate or felt are not acceptable roof coverings in conservation areas. Where a roof in a conservation area is being re-covered, the choice of covering should replicate the original, usually natural slate or clay tile.

### Valley or Butterfly roofs

- 5.19 On buildings with a 'valley' or 'butterfly' roof if a mansard extension is considered acceptable in terms of the guidance in paragraphs 5.7 and 5.8 of this chapter, then the parapet should be retained. The new roof should start from behind the parapet at existing hopper-head level, forming a continuous slope of up to a maximum of 70° (see Figure 6). In this context, it is usually more appropriate to introduce conservation-style roof lights, which are flush with the roof slope, rather than dormers. Terraces and additional railings will not usually be acceptable.

**Figure 6. Butterfly roofs**

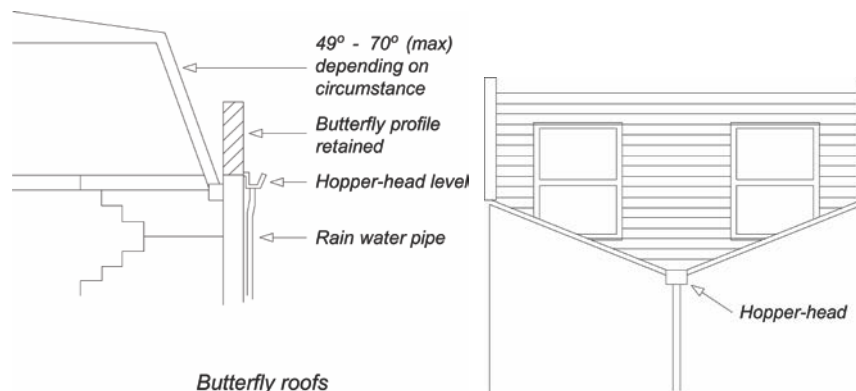

#### **Hopper head level**

The level at which the 'hopper head' (a square or funnel shaped receptacle to connect rainwater or waste pipes to a down-pipe) is positioned.

### Other roof additions

- 5.20 On some contemporary buildings a less traditional form of roof addition may be more appropriate. In such cases, proposals should still have regard for the following general principles:
- The visual prominence, scale and bulk of the extension;
  - Use of high quality materials and details;

- Impact on adjoining properties both in terms of bulk and design and amenity of neighbours, e.g. loss of light due to additional height;
- Sympathetic design and relationship to the main building.

### **Roof lights**

- 5.21 Roof lights can have an adverse impact upon the character and appearance of buildings and streetscapes. This occurs where they are raised above the roof slope rather than being flush with the roof profile, or where they are an incompatible introduction into an otherwise uncluttered roofscape, or where they conflict with other architectural roof elements, e.g. gables and turrets.
- 5.22 Roof lights should be proportioned to be significantly subordinate both in size and number and should be fitted flush with the roof surface. Some properties, particularly listed buildings and those within conservation areas with prominent roof slopes may be so sensitive to changes that even the installation of roof lights may not be acceptable.

### **Balconies and terraces**

- 5.23 Balconies and terraces can provide valuable amenity space for flats that would otherwise have little or no private exterior space. However, they can also cause nuisance to neighbours. Potential problems include overlooking and privacy, daylight, noise, light spillage and security.
- 5.24 Balconies and terraces should form an integral element in the design of elevations. The key to whether a design is acceptable is the degree to which the balcony or terrace complements the elevation upon which it is to be located. Consideration should therefore be given to the following:
- detailed design to reduce the impact on the existing elevation;
  - careful choice of materials and colour to match the existing elevation;
  - possible use of setbacks to minimise overlooking – a balcony need not necessarily cover the entire available roof space;
  - possible use of screens or planting to prevent overlooking of habitable rooms or nearby gardens, without reducing daylight and sunlight or outlook; and
  - need to avoid creating climbing opportunities for burglars.

### **Roof Level**

- 5.25 A terrace provided at roof level should be set back behind the slope of a pitched roof in accordance with Figure 7, or behind a parapet on a flat roof. A terrace should normally comply with the following criteria:
- The dimensions of the roof should be sufficient to accommodate a terrace without adversely affecting the appearance of the roof or the elevation of the property.
  - A terrace will only normally be acceptable on the rear of properties. It is normally inappropriate to set back a mansard to provide a terrace.

- It should not result in the parapet height being altered, or, in the case of valley/butterfly roofs, the infilling of the rear valley parapet by brickwork or railings.
- Any handrails required should be well set back behind the line of the roof slope, and be invisible from the ground.
- It should not result in overlooking of habitable rooms of adjacent properties.

- 5.26 When a terrace is provided within the slope of a pitch as in Figure 7, the adjacent tiles or slates should be kept unbroken above the eaves. The width of the terrace should be no wider than a dormer opening. A terrace may be acceptable behind an existing parapet. Where the height of the parapet is less than 1.1m, a railing will be required to fulfil Building Regulations.

**Figure 7. Roof terraces**

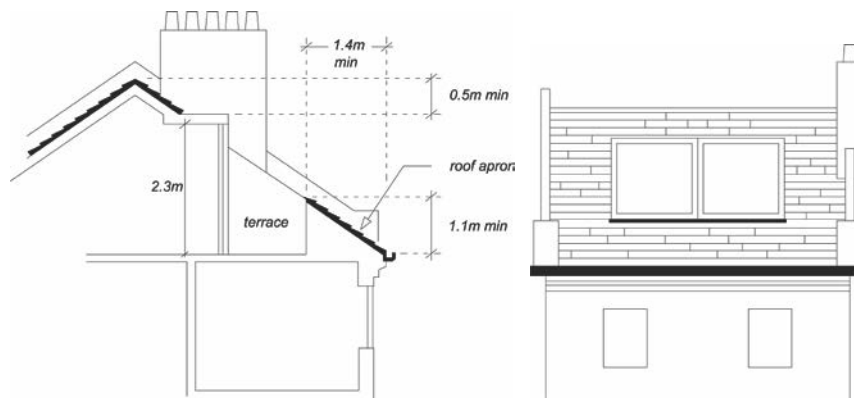

### **Building services equipment**

- 5.27 New building services equipment and water tanks should be accommodated within the envelope of the building and its siting should be considered as part of the overall design (see chapter on Building services equipment in this CPG). Building services equipment includes, but is not limited to, heating and cooling systems, ventilation and extraction systems and associated ducting for electricity, communications and plumbing.

### **Green roofs**

- 5.28 We encourage the incorporation of green roofs into schemes where appropriate in design terms (see chapter on Green roofs and walls in CPG3 Sustainability). You should contact the Council to confirm whether planning permission is required for green roofs. Planning permission is not required on flat roofs which are concealed by a parapet.

### **Solar panels**

- 5.29 We encourage the installation of solar panels into schemes and for some properties these will not need planning permission. You should

contact the Council and visit the Planning Portal website [www.planningportal.gov.uk](http://www.planningportal.gov.uk) to confirm whether planning permission is required for solar panels. Solar panels should be sited so as to maximise efficiency but minimise their visual impact and glare, for example utilising valley roofs and concealed roof slopes. Reference should be made to CPG3 Sustainability (Energy Efficiency: existing buildings and Energy Efficiency: new buildings chapters).





## 6 Landscape design and trees

### KEY MESSAGES

- Camden's trees and green spaces are integral to its character.
- Landscape design and green infrastructure should be fully integrated into the design of schemes from the outset.
- We require a survey of existing trees and vegetation to be carried out prior to the design of a scheme.

- 6.1 This guidance sets out how to protect trees and vegetation and design high quality landscapes in conjunction with development proposals to ensure an attractive, safe, accessible, sustainable and ecologically diverse environment.
- 6.2 This chapter sets out:
- how existing trees and landscape should be protected;
  - what specific protection is given to some trees;
  - how new landscaping should be incorporated into developments; and
  - considerations for specific landscaped areas and types of landscaping.
- 6.3 The green landscape of the Borough is formed by parks and open spaces, railway and canal corridors, trees, gardens, green walls and roofs. These landscape components provide Camden's green infrastructure and play a key role in maintaining the local climate, reducing storm water run off, increasing biodiversity, providing space for urban food production and providing public enjoyment.
- 6.4 We expect landscape design and the provision of green infrastructure to be fully integrated into the design of development proposals from the beginning of the design process.
- 6.5 This section sets out further guidance on how we will apply Core Strategy Policy CS14 Promoting high quality places and conserving our heritage and Development Policy DP24 Securing high quality design.

### **Where does this guidance apply?**

- 6.6 This guidance applies to all proposals affecting or including landscape design on and around buildings and proposals relating to on and off site trees.

### **How should existing Trees and Landscape be protected?**

#### **Benefits of retaining vegetation and trees**

- 6.7 Vegetation of all types is at a premium in Camden given the Borough's dense urban environment. Camden's tree canopy and other existing vegetation are integral to its character. If you maintain existing trees and

vegetation on a development site it will help provide a sense of maturity to a development and integrate a development into its setting. Existing trees and vegetation are a key component in adapting to climate change and conserving biodiversity. See CPG3 Sustainability chapters on Climate change adaptation and Biodiversity. Existing species can serve as an indicator of what might be successfully grown on the site when selecting additional plants. The retention of existing mature trees and vegetation also make an important contribution to the sustainability of a project. For example by reducing the impacts and energy demand associated with the provision of new plants such as in their transportation and the irrigation required.

### **How should existing trees and vegetation be protected?**

- 6.8 We will require a survey of existing trees and vegetation to be carried out prior to the design of a scheme in order to identify what trees and vegetation should be retained and protected on site. We will expect developers to follow the principles and practices set out in BS 5837: 2005 Trees in relation to construction to integrate existing trees into new developments.



- 6.9 BS5837: 2005 Trees in relation to construction outlines the survey method for identifying which trees should be retained and protected. Once the survey has identified the important trees and vegetation a Tree Constraints Plan (TCP) needs to be prepared for the site. The TCP is essential to site planning as it provides the limitations for development including:
- site layout and building lines;
  - changes in levels;
  - foundation design; and

- service provision where the root zones and crown spread of trees are to be protected.

#### **NEW UTILITIES**

Useful guidance for the installation of new utilities in the vicinity of trees is also provided in National Joint Utilities Group (NJUG) Vol 4 - Guidelines for the Planning, Installation and Maintenance of Utility Apparatus in Proximity to Trees

- 6.10 The TCP should also identify the provision of sufficient space, above and below ground for new planting to develop and mature and existing trees to continue to grow (see paragraph 6.42 below regarding soft landscape design).
- 6.11 Where trees are identified to be retained it is imperative that contracting and site supervision procedures are in place to ensure that there is no damage during and after construction. We will normally seek a Method Statement which sets out how trees that are to be retained, both on and adjacent to the site will be protected. The Method Statement should identify how the provision of site accommodation, storage areas, site access and the positioning, heights and arcs of cranes will not affect the trees and vegetation that are to be protected.

#### **Root zone**

The area and volume of soil around the tree in which roots are found. May extend to three or more times the branch spread of the tree, or several times the height of the tree.

#### **Crown spread**

The extent of the branches, twigs and leaves that form the top of the tree

#### **Specific protection for trees**

- 6.12 Where a planning application involves works that affect trees either within the application site or on adjacent land (including street trees) we will require the following information to determine the application:
1. A Tree Survey  
(see section 4.2 of BS5837:2005)
  2. A Tree Constraints Plan  
(see sections 5.2 and 5.3 of BS5837:2005)
  3. An Arboricultural Implications Assessment  
(see section 6 of BS5837:2005)
  4. An Arboricultural Method Statement for the protection of trees to be retained including a Tree Protection Plan  
(see section 7 of BS5837:2005)
- 6.13 Failure to supply the documents outlined above may lead to a planning application not being validated.

- 6.14 To obtain a copy of BS5837:2005 please visit [www.StandardsUK.com](http://www.StandardsUK.com) and for a list of arboricultural consultants visit [www.trees.org.uk](http://www.trees.org.uk), [www.charteredforesters.org](http://www.charteredforesters.org) and [www.consultingarboristssociety.co.uk](http://www.consultingarboristssociety.co.uk).

### **Tree preservation orders**

- 6.15 Many trees in Camden are covered by a Tree Preservation Order (TPO). Please contact the Council to find out if a tree is protected by a TPO.

#### **TREE PRESERVATION ORDER**

A tree preservation order is made by the Council to legally protect specific trees or groups of trees that provide public amenity.

Unauthorised works to a tree with a TPO is a criminal offence and may result in prosecution and, upon conviction, a fine.

- 6.16 Works (above or below ground) to trees with a TPO require our permission. Application forms for these works are available at [www.camden.gov.uk](http://www.camden.gov.uk).
- 6.17 Works to a tree with a TPO required to enable the implementation of a planning permission are dealt with as part of a planning application. A further TPO application is not required.

### **Trees in Conservation Areas**

#### **SECTION 211**

Under Section 211 of the Town & Country Planning Act 1990, anyone proposing to cut down or carry out work on a tree in a Conservation Area must provide the Council 6 weeks notice of their intention to do so.

- 6.18 All trees in Conservation Areas with a trunk diameter of 75mm or greater measured at 1.5m above ground level are protected under section 211 of the Town and Country Planning Act 1990 (as amended). If you are proposing works to a tree in a Conservation Area, above or below ground, you are required to give Camden Planning Services six weeks notice of your proposals (See above link for forms). Works to a tree in a Conservation Area required to facilitate the implementation of a planning permission are dealt with as part of a planning application. A further section 211 Notification is not required. If you carry out unauthorised works to a tree in a Conservation Area is a criminal offence and may result in prosecution and, upon conviction, a fine.

### **How should new landscaping be included into a development?**

#### **General principles**

- 6.19 Urban landscape design encompasses the following types of spaces:
- streets and associated public spaces,
  - parks, public and private squares, gardens,
  - amenity and servicing space around buildings; and

- buildings themselves.

6.20 The principle components of landscape design are soft landscape details (planting) and hard landscape details (the constructed aspects of design) for example surfaces, lighting, seating, water features and boundary treatments.

6.21 Urban spaces have particular character which results from a combination of factors including geology, ecology, topography and the history of their development and use. We will expect new landscape design to respond to, preserve and enhance local character, including through the:

- preservation of existing trees and hedges;
- planting of new trees and hedges; and
- detailed design of boundary treatments and spaces within the site particularly where they are visible to the public domain.



6.22 Planning applications will be assessed against

- the successful resolution of the above elements into the design of the site
- whether the site design has optimised opportunities to increase a site's sustainability and function in adapting to climate change (see CPG3 Sustainability for further details on Biodiversity and Climate change adaptation)
- the need to reduce opportunities for criminal behaviour (see the chapter in this guidance on Designing safer environments)
- the need to provide inclusive environments (see CPG6)

### **Specific areas that are landscaped and contain trees**

6.23 Areas within a development site that are generally landscaped include:

- gardens;
- access and servicing routes;
- parking spaces and cycle stores;
- boundary walls, fences and railings; and



- building roofs and walls.

### Gardens

- 6.24 Front, side and rear gardens make an important contribution to the townscape of the Borough and contribute to the distinctive character and appearance of individual buildings and their surroundings. Gardens are particularly prone to development pressure in the Borough with their loss resulting in the erosion of local character and amenity, biodiversity and their function in reducing local storm water run off.

### Front Gardens

- 6.25 The design of front gardens and forecourt parking areas make a large impact on the character and attractiveness of an area and in particular the streetscene. The design of front gardens and other similar forecourt spaces should:
- consider a balance between hard and soft landscaping. Where changes take place no more than 50% of the frontage area should become hard landscape. Where parking areas form part of the forecourt enough of the front boundary enclosure should be retained to retain the spatial definition of the forecourt to the street and provide screening;
  - retain trees and vegetation which contribute to the character of the site and surrounding area;
  - retain or re-introduce original surface materials and boundary features, especially in Conservation Areas such as walls, railings and hedges where they have been removed. If new materials are to be introduced they should be complementary to the setting; and
  - prevent the excavation of lightwells as a means of providing access to basements where this does not form part of the historical means of access to these areas.





## Paving of front gardens

### CHANGES TO PERMITTED DEVELOPMENT

The General Permitted Development Order no longer allows the creation of more than 5 square meters of impermeable surfaces at the front of dwelling houses that would allow uncontrolled runoff of rainwater from front gardens onto roads without first obtaining planning permission.

Changes to frontages incorporating hard standings may also be affected by Article 4 Directions. Article 4 Directions are issued by the Council in circumstances where specific control over development is required, primarily where the character of an area of acknowledged importance would be threatened, such as conservation areas

- 6.26 Planning Permission will not be granted for hard standings greater than five square metres that do not incorporate sustainable urban drainage systems (SUDS) into the design. SUDS incorporate permeable surfaces to allow water to soak into the subsoil, rather than being diverted into the stormwater system. SUDS are particularly appropriate in the parts of the borough north of Euston Road as this area has predominantly clay soils. Methods for choosing the appropriate design of a SUDS are provided in “Responsible rainwater management around the home” available from [www.paving.org.uk](http://www.paving.org.uk). Planning applications which incorporate car parking areas into developments will be required to demonstrate that the chosen solution is appropriate to the underlying soil type.

### Creating a cross over

- 6.27 For single family dwellings planning permission is not required for the creation of a cross over unless the property is affected by an Article 4 Direction or the cross over is to a classified road. However permission is required for the formation of a cross over from the Highways Authority. The Highways Authority will generally refuse permission where it would result in the loss of on street car parking spaces.
- 6.28 Planning permission is required for forecourt parking at the fronted of buildings divided into flats. Listed Building Consent is required to alterations to structures affecting listed buildings including structures within their curtilage.

#### Listed building consent

Legally required in order to carry out any works to a Listed Building which will affect its special value. This is necessary for any major works, but may also be necessary for minor alterations and even repairs and maintenance. Listed Building Consent may also be necessary for a change of use of the property.

## Rear Gardens

- 6.29 Rear gardens are important as they:
- form part of the semi public domain where they are over looked by large numbers of properties and the occupants of surrounding buildings benefit from the outlook.

- form the character of an area in terms of the relationship between buildings and spaces and the resulting openness or sense of enclosure
- provide a sense of the greenery where they can be viewed through gaps between buildings
- provide a sense of visual separation and privacy
- soften the impact of buildings and integrate them into their setting
- play a significant role in maintaining the biodiversity of the borough (see CPG3 Sustainability for further details on Biodiversity). In particular groups of trees and vegetation along the rear boundaries of garden provide important wild life corridors within existing development patterns.

6.30 The potential detrimental affects of new structures in gardens can be reduced by:

- carefully siting structures away from vegetation and trees,
- designing foundation to minimises damage to the root protection zones of adjacent trees,
- including green roofs, green walls on new development and vegetation screens.

**Root protection zone**

The area around the base or roots of the tree that needs to be protected from development and compaction during construction to ensure the survival of the tree.

6.31 Planning permission is unlikely to be granted for development whether in the form of extensions, conservatories, garden studios, basements or new development which significantly erode the character of existing garden spaces and their function in providing wildlife habitat (See the chapters on Extensions, Alterations and Conservatories in this guidance document, and CPG4 on Basements).

**Access and servicing areas**

6.32 Where underground parking and/or servicing forms part of a larger development, access should be integral to the design of the development. Entrances and ramps should be discrete.

6.33 Entrances and adjoining areas of buildings are often spaces which require the integration of a number of competing needs such as the provision of bins, cycle storage, meters and inspection boxes and external lighting. These elements should be constructed with materials sympathetic to the site and surroundings. You can minimise the visual impact of storage areas by careful siting and incorporating planters to screen developments and incorporating green roofs as part of their structure.

6.34 Space and location requirements for the storage of waste and recycling can be found in this guidance in chapter on Waste and recycling

storage. Further guidance on how access to site and parking areas should be designed can be found in CPG6 Transport.

### **Boundary Walls, Fences and Railings**

- 6.35 Boundary walls, fences and railings form the built elements of boundary treatments. They should be considered together with the potential for elements of soft landscaping. For example, we encourage the combination of low brick boundary walls and hedges as a boundary treatment. Boundary treatments should:
- delineate public and private areas;
  - contribute to qualities of continuity and enclosure within the street scene; and
  - provide site security and privacy.
- 6.36 Due to the prominence of the boundary treatments in the streetscene we will expect the design, detailing and materials used to provide a strong positive contribution to the character and distinctiveness of the area and integrate the site into the streetscene.
- 6.37 With regards to boundary walls, fences and railings, we will expect that:
- you consider repairing boundary walls, fences and railings before they are replaced;
  - they make a positive contribution to the appearance and character of the development site and to the streetscene;
  - you consider designs to be effective for their function.
  - the design and construction does not damage any on site or off site trees that are identified for retention (See paragraphs 6.15 to 6.18 above).
- 6.38 For boundary treatments around listed buildings or in a conservation area we will expect:
- the elements are repaired or replaced to replicate the original design and detailing and comprise the same materials as the original features
  - the works preserve and enhance the existing qualities and context of the site and surrounding area
- 6.39 Planning Permission is not required for the erection of a boundary treatment no higher than 1m where it abuts the highway or 2m on any other boundary. These heights are measured from ground level and include any structure that may be attached for example a trellis attached to the top of boundary wall.
- 6.40 Listed Building consent may be required for any works to boundary treatments within the curtilage of a listed building.

### **Types of landscaping**

- 6.41 Landscaping are divided into the following broad types:

- soft landscaping (planting);
- hard landscaping; and
- landscaping on building.

#### **Soft Landscape Details (Planting)**

6.42 Soft Landscape is a term to describe the organic, vegetative or natural elements of Landscape Design. There are three main objectives in planting design (1) Functional (2) Ecological and (3) Aesthetic. Each of these objectives is likely to be inter related however one may be prioritised over another for the purpose of a particular project.

6.43 Functional objectives include:

- integrating a site with its surroundings;
- providing spatial definition and enclosure;
- directing pedestrian and vehicular movement;
- providing shelter,
- providing micro climatic amelioration and
- providing SUDS.

#### **Ecological Objectives include:**

- maintaining and enhancing natural processes; and
- increasing the biodiversity value of a site.

#### **Aesthetic Objectives include:**

- creating or contributing to the character of a place; and
- adding to people's sensory enjoyment in the use of a space.

<b>Crown canopy</b>
---------------------

The uppermost layer in a forest or group of trees.
--

6.44 Landscaping schemes need to maintain and plant large canopy trees as a means of countering the negative effects of increasing urban temperatures due to climate change. Existing large canopy trees are part of the character of several areas in the Borough. In these areas in particular and other areas where the opportunity arises space should be made for the growth and development of large canopy trees. Large canopy trees are usually considered to be trees which reach a mature height of 15-20m+. Site design should make provision for the expansion of the crown canopy of these trees and sufficient soil volume to support a trees growth to maturity. As a general rule the soil volume required to support a healthy large canopy tree is 6m x 6m x 1m depth. The detailed requirements for the growth and development of large canopy urban trees can be found in "Up by the Roots" by James Urban (International Society for Arboriculture, 2008).

6.45 The long term success of planting schemes will determine species selection suitable for local growing conditions (soil conditions, temperature ranges, rainfall, sun light and shade) and provision for on

going maintenance. Generally native species are considered to be most adapted to local conditions however there are a range of exotic plants which are at least equally adaptable to the unique ecology of urban areas and which provide an important contribution to a site's biodiversity.

- 6.46 Maintenance requirements should be considered at the design stage in terms of ensuring there is access for maintenance, whether maintenance materials need to be stored on site and that there are available sources of water. Water conservation should be intrinsic to the design of a planting scheme whether it is by selecting drought tolerant plants, maintaining soil conditions conducive to water retention with, for example, mulching or providing for on site water harvesting and grey water recycling.
- 6.47 Planning applications will be assessed against the degree to which planting schemes meet their objectives and that the chosen objectives are appropriate for the site. Planning applications should be accompanied by:
1. a statement of the design objectives of planting plans;
  2. planting plans indicating species, planting patterns, planting size and density; and
  3. where appropriate managements plans.

#### **Hard Landscape Details**

- 6.48 Hard landscape is a term used to describe the hard materials used in landscape design such as paving, seating, water features, lighting, fences, walls and railings (see paragraphs 6.35 to 6.38 above for guidance on boundary walls, fences and railings and the chapter on Design excellence regarding the design of public space).
- 6.49 Hard landscape makes a significant contribution to the character of the Borough. The scale, type, pattern and mix of materials help define different uses and effects the perception of the surrounding buildings and soft landscape and overall quality of an area. To help integrate the development with its surroundings and contribute to the sustainability of the project we will expect:
- the selection of materials, patterning and methods of workmanship to consider those already at use in the area;
  - traditional and natural materials to be used, especially in Conservation Areas (Guidance can be found in Conservation Area Statements, Appraisals and Management Plans);
  - the use of salvaged and re used materials, where appropriate; and
  - all paving to be level and accessible where used by pedestrians, this needs careful consideration where the use of historic materials is proposed.
- 6.50 The Council will discourage the replacement of soft landscaping with hard landscaping in order to preserve the environmental benefits of vegetation identified above. However where hard landscape is

unavoidable we will seek sustainable drainage solution to any drainage (see CPG3 Sustainability chapter on Flooding).

### **Lighting**

- 6.51 Lighting can make an important contribution to the attractiveness of an area. It is also important for the security and safety of an area. The design and siting of columns and lights can provide a significant role in the creation of the character of a place. Other lighting techniques include wall mounting, bollards with integral lights and ground level up lighters. While adequate lighting is required, the intensity of lighting should be appropriate to its function. Care should be taken not to over light which can lead to unnecessary light pollution and energy consumption and in some cases become a nuisance to neighbouring residential properties. Lightning can also become a disturbance to local wildlife, particularly bats, and can affect the wildlife that uses and lives on the canal.

### **Landscaping on buildings**

- 6.52 Landscaping on buildings includes both soft and hard landscaping and occurs in the forms of green and brown roofs and green walls. Green roofs, brown roofs and green walls can provide important landscape detail, biodiversity improvements, prevent local flooding and keep a building insulated. See CPG3 Sustainability (Green roofs and walls chapter).

## 7 Shopfronts

### KEY MESSAGES

Shopfront alterations should respect the detailed design, materials, colour and architectural features of the shopfront and building itself.

This section provides information on how to deal with the five key shopfront features:

- Shopfront components,
- Signs and lighting,
- Blinds and canopies,
- Security shutters,
- Cash machines.

- 7.1 Well designed shopfronts increase the attractiveness of a building and the local area and can have an impact on commercial success by increasing the attraction of shops and shopping centres to customers. This is particularly important in town centres and the character and appearance of where conservation area and listed buildings. On the other hand, insensitive shopfront design can harm the appearance and character of buildings and shopping areas
- 7.2 This guidance relates to Core Strategy Policy – CS14 – Promoting High Quality places and Conserving Our Heritage and Development Plan Policies – DP30 – Shopfronts – and to planning applications for new shopfronts and alterations for existing.



### When does this guidance apply?

#### General

- 7.3 This guidance applies to all applications which may materially alter the external appearance of a building or any element of the historic environment and therefore may require planning permission, or conservation area or listed building consent.



- 7.4 You will generally need planning permission for:
- a new shopfront;
  - alterations to an existing shopfront including awnings and canopies, external security shutters, blinds, grilles and security measures; and
  - change of use will generally require planning permission.
- 7.5 Planning permission is not normally required for routine maintenance works, such as redecoration or straightforward repairs. For further detailed guidance check with the Council.
- 7.6 Any alterations (or replacement) of shopfronts that form part of a listed building will require Listed Building Consent and will need to be consistent with the age and style of the building. For further information see the chapter 3 Heritage of this CPG. More stringent controls will apply for the following works:
- re-painting a shopfront in a different colour,
  - installing a security alarm or extractor fan,
  - altering the shop interior,
  - installing blinds or shutters, and
  - advertisements.
- 7.7 Conservation Area Consent is required for the proposed complete or substantial demolition of any building in a conservation area. This includes the removal of a shopfront or of any feature that gives character to a building. In assessing applications to alter shopfronts within conservation areas special attention will be given to the desirability of preserving and enhancing the character and appearance of the Conservation Areas (for further information see chapter 3 Heritage of this CPG).
- 7.8 For shops in conservation areas, reference should also be made to the relevant Conservation Area Statement/Conservation Area Appraisal & Management Strategy (there are 39 in total). These describe the area and its special character and include guidelines that provide the framework for development proposals in the area and the appraisals contain audits of shopfronts of merit.
- 7.9 Advertisement consent is a separate procedure that applies to the display of advertisements on shopfronts. You can find further guidance in the document Outdoor advertisements and signs: A guide for advertisers (CLG, 2007) and chapter 8 'Advertisements, signs and hoardings' of this CPG).

#### **BUILDING REGULATIONS APPROVAL**

You need building regulations approval for all work which alters the shop's structure, entrance arrangement, changes its fire escape, or affects the level of access currently provided.

## Guidance for Shopfronts

### Design and appearance of shopfronts

7.10 The basic architectural features that make up shopfronts are illustrated in Figure 8.

Figure 8. Shopfront elements

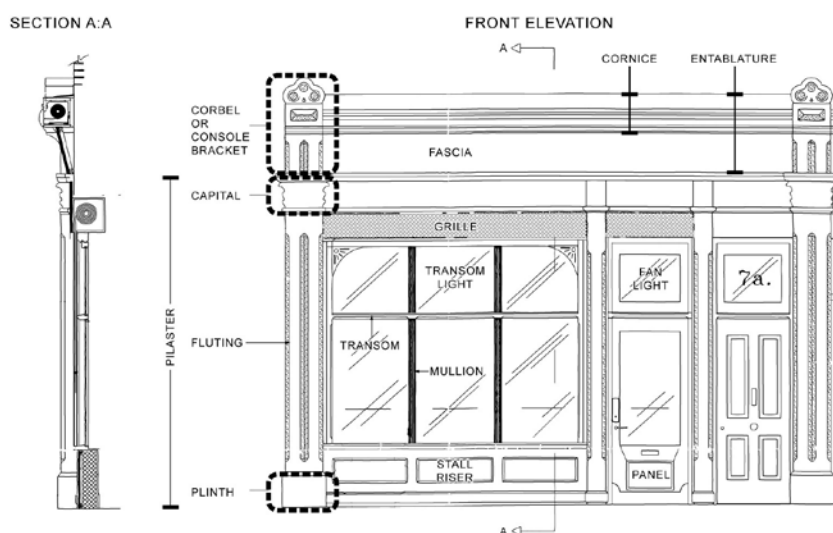

### General principles

7.11 Shopfront alterations should respect the detailed design, materials, colour and architectural features of the shopfront and building itself, the following will need to be considered:

- Historic, locally distinctive or characteristic shopfronts which contribute to the townscape should be retained. In some cases the reinstatement of missing features will be encouraged.
- New shopfronts should be designed as part of the whole building and should sensitively relate to the scale, proportions and architectural style of the building and surrounding facades.
- Shopfronts forming part of a larger new development should be considered as an integral part of the overall design.
- Standardised “house-style” frontages may have to be amended in order to harmonise with the surrounding context and respect the building, particularly in conservation areas and for listed buildings.
- All shopfronts should be designed to provide access into the premises for all.

## Key shopfront components

- 7.12 The following are key shopfront design components you need to consider when making alterations to an existing shopfront:

### Window Displays

- The window display is the main visual element of a shopfront. Shop frontages should be largely glazed to maintain a window display rather than creating a solid frontage (including obscured glass) which will be discouraged.
- On traditional shopfronts large expanse of undivided glass should be avoided. Vertical glazing bars (mullions) should be used to subdivide large windows to help visually relate the shopfront with the upper elevations of the building.

### Entrances

- The design of the door should be in keeping with the other elements of the shopfront. The solid bottom panel should align with the stallriser. The top of the door should align with the transom.
- Decorative tiling should be retained.
- All new build shop units and shopfronts should be designed to be fully accessible to everyone.
- In the case of existing buildings, particularly where a new shop front is proposed, the following guidance should be followed:
  - Shops that have a change in level from pavement to shop floor surface can usually incorporate ramped access into or within the shop. Exceptions preventing a ramped area to be created may include the presence of structural beams or floor slabs..
  - Entrance doors should be accessible to all, particularly wheelchair users and people with limited manual dexterity. 1000mm minimum clear door width in new buildings and 775mm door width in existing buildings where a new shop front or alterations to a shop front are proposed.
- to ensure that services are reasonably accessible to disabled people refer to Camden Planning Guidance on Access for all.

### Shopfront recess

- Where there is an existing shopfront recess - often found in older traditional shopfronts e.g. listed buildings and conservation areas - they should be retained.
- Traditional horizontally-operated lattice security gates can in some cases be employed to protect recessed shop entrances, but they should not extend across windows. On traditional shopfronts, removable timber or metal lattice style shutters is often more appropriate.
- New recesses in shopfronts will be strongly discouraged due to their potential for attracting anti-social behaviour.

## **Fascias**

- The fascia should be of a suitable size and proportion in relation to the building and should not normally extend above the cornice or below the capital as it would upset the overall balance and proportions of a shopfront or parade (see Figure 9 and Figure 10).
- Fascia signs should not obscure or damage existing architectural features. Deep box fascias which project beyond the shopfront frame should be avoided.
- Lettering on fascia signs should be proportionate to the scale of the shopfront. To aid identification, fascia signs should include the street number of the premises.
- Where a shopfront and fascia extend across two or more shop unit bays, the removal of intervening pilasters are not acceptable as it would:
  - weaken the frame's visual support to the upper floors; and
  - disrupt the character and rhythm of a shopping frontage created by the widths of individual shopfronts.
- Lettering on fascia signs should be proportionate to the scale of the shopfront. Main fascias should also be of a suitable size and proportion in relation to the building and should sit between cornice and shopfront itself and should not project above or below the cornice level obscuring upper floor or shop windows.
- Fascia and box signs should not obscure or damage existing architectural features.

Figure 9. Good shopfront section and elevation

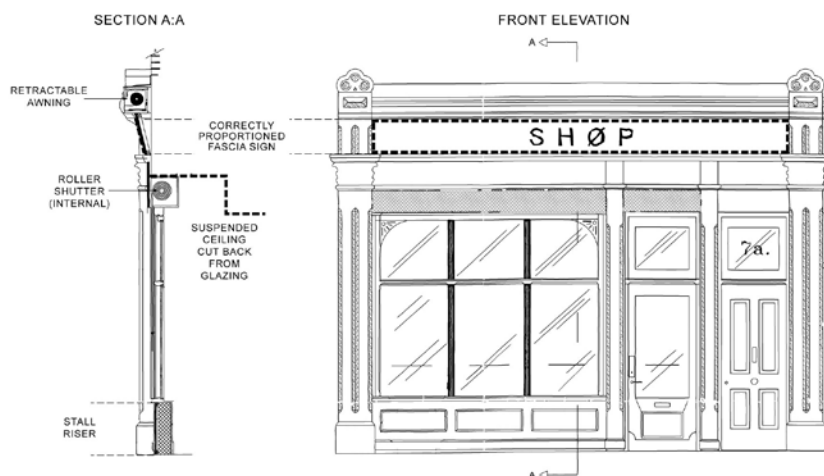
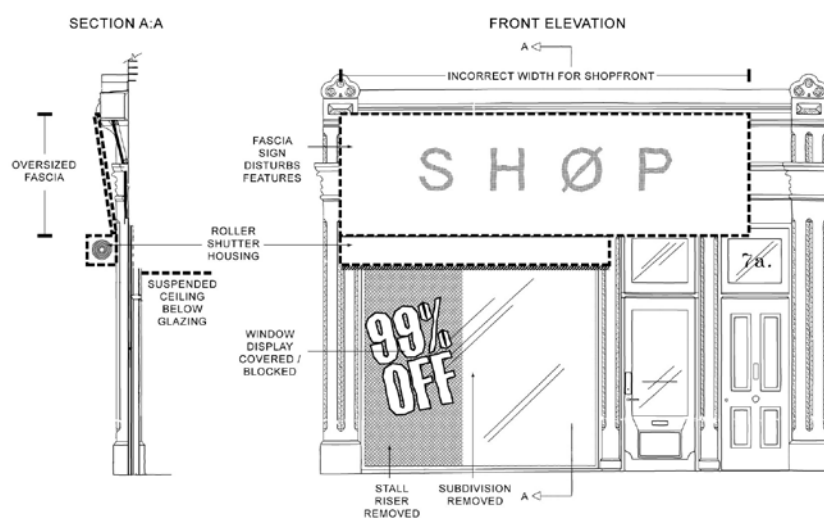

Figure 10. Inappropriate shopfront section and elevation



### Pilasters

- New pilasters are preferably placed in line with solid wall, not windows above, to emphasise their function. This is particularly important in the case of shopping frontages on sloping sites where existing stepped profiles of fascias and stallrisers should be preserved or reintroduced wherever possible.

### Stallrisers

- Stallrisers consist of solid elements below shop windows. They form a base to the shopfront display, and prevent the glazing from being damaged or soiled.
- Stallrisers should be retained and generally incorporated to any new shopfront on a period buildings.

- Where stallrisers are provided, they should be at least 300mm high or to the top of the pilaster base or door panel and faced in appropriate materials for the context. They should not provide ledges that can be sat upon. Glazing should be brought to the front of a stallriser.

### **Colour and materials**

- Materials should be chosen for their durability and appropriateness to their location. Traditional materials such as timber, stone and render are the most appropriate for new shopfronts, particularly for listed buildings and in conservation areas.
- More contemporary materials such as colour-coated steel, aluminium and bronze instead of timber may be appropriate in some circumstances.
- Existing glazed brickwork or tiling should be retained.
- Colour schemes for shopfronts and in particular the projecting framework should be carefully considered, particularly in conservation areas and for listed buildings.
- Proposals should be accompanied by full details of materials, finishes and colours (or sample and specification cards).

### **Folding shopfronts**

- Folding shopfronts are not generally acceptable, particularly those on historic buildings such as listed buildings and those in Conservation Areas. When open, they erode the appearance of the shopfront, creating a visual void, and can increase disturbance to neighbouring properties, particularly in the case of food and drink premises. When closed they appear as a row of doors rather than a shopfront. This creates a heavier appearance than a shopfront mullion and reduces the area of glass in the shopfront.

### **Lightwells / grilles**

- Pavement lights or small lightwells covered with metal grilles are typically found in front of shopfronts. These provide light into the areas beneath whilst allowing shoppers close inspection of the window display.
- Creating open lightwells with railings in front of a shopfront is not generally acceptable as it prevents window shopping and disrupts the buildings relationship to the rhythm of the street. This is also the case if the shopfront has been converted into residential accommodation.

### **Advertisements and signs**

- 7.13 Shops and businesses need to ensure that their name and other details are clearly displayed on their premises and, as a result, signs are among the most prominent forms of advertising on buildings. However, signs that are unsympathetically designed can cause significant harm to the building and the local townscape. Signs should relate well to the

character, scale and architectural features of the building and respect their local context.

- 7.14 Properties should only have one main fascia sign and one ancillary projecting or hanging sign per street frontage, although two projecting signs may be appropriate in cases of large shopfronts stretching across two or more shop units. Too many adverts/signs on a property contribute to visual clutter and can detract from the appearance of the street scene.

### **Projecting and hanging signs**

- 7.15 Projecting and hanging signs should normally be level with the fascia rather than below or above it. They should be positioned to the side of the shopfront at fascia level.
- 7.16 Signs at upper floor levels will be discouraged. Advertising for upper floor premises by lettering on windows or by suspended banners on large frontages will only be considered acceptable where advertising a specific event for a temporary period.
- 7.17 Advert signs - including those on canopies/blinds, should:
- be considered as an integral part of a shopfront or building, designed in from the outset with new structures;
  - be in harmony with the existing building, and neighbouring ones, in terms of their proportions, design and materials;
  - See Camden Planning Guidance on Advertisements, signs and hoardings.

### **Canopies, awnings and blinds**

- 7.18 Blinds can add colour and interest to the street scene. However, it is important to ensure that they do not dominate a shopfront or shop parade.

#### **Canopy**

A decorative structure providing a sheltered walk to the entrance of a building.

#### **Awning**

A sheet of canvas or synthetic fabric hung above a shopfront as protection against rain or sun

#### **Blind**

A structure of canvas or other material stretched used to keep sun or rain off a shop window.



7.19 Shopfront canopies and blinds are only likely to be acceptable where they are:

- retractable;
- traditional canvas;
- blind box integrated with the overall design;
- attached between the fascia and shopfront; and
- be flush with the fascia level.

Figure 11. Appropriate ways to install shopfront awnings

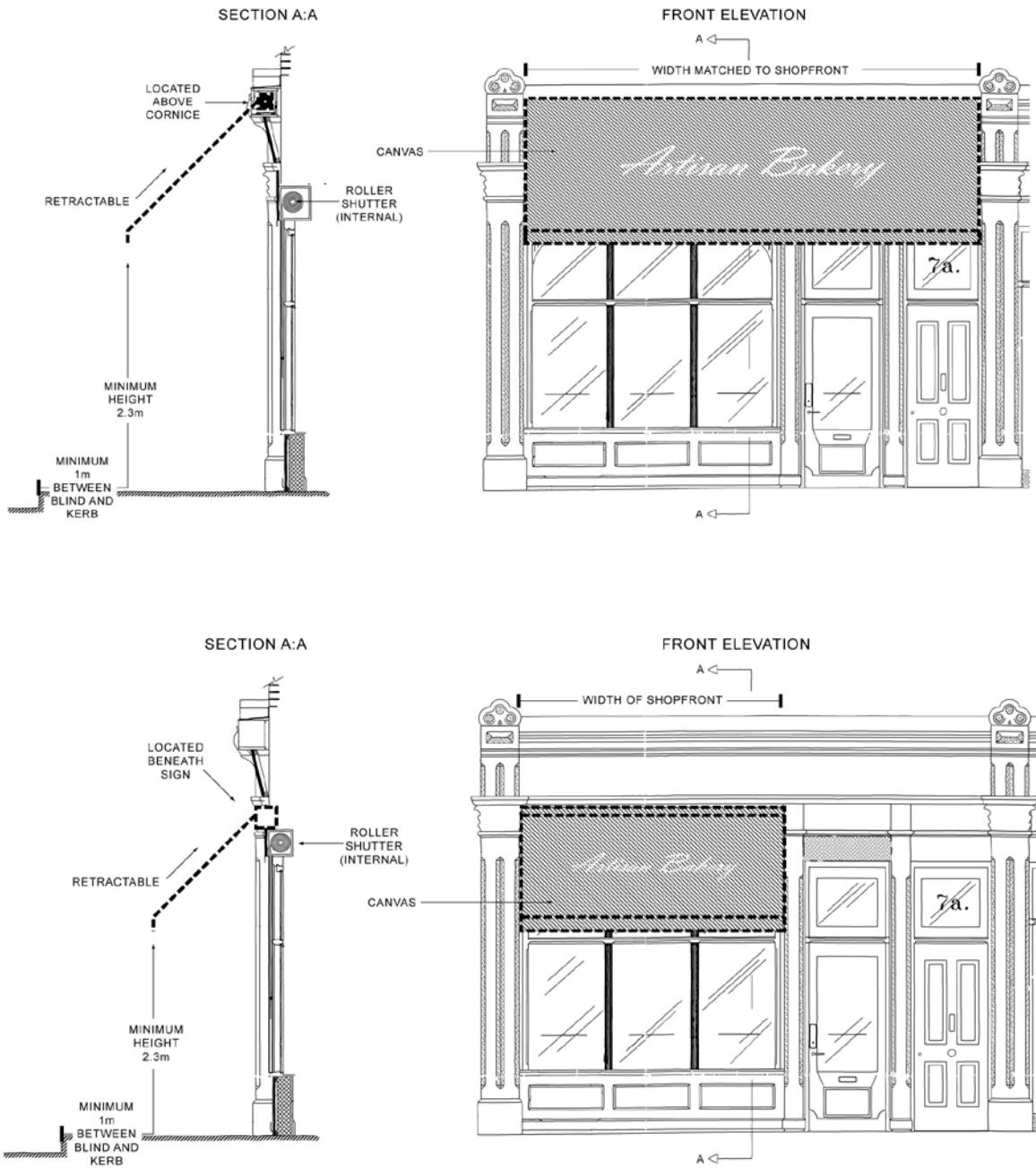

### Inappropriate ways to install shopfront awnings

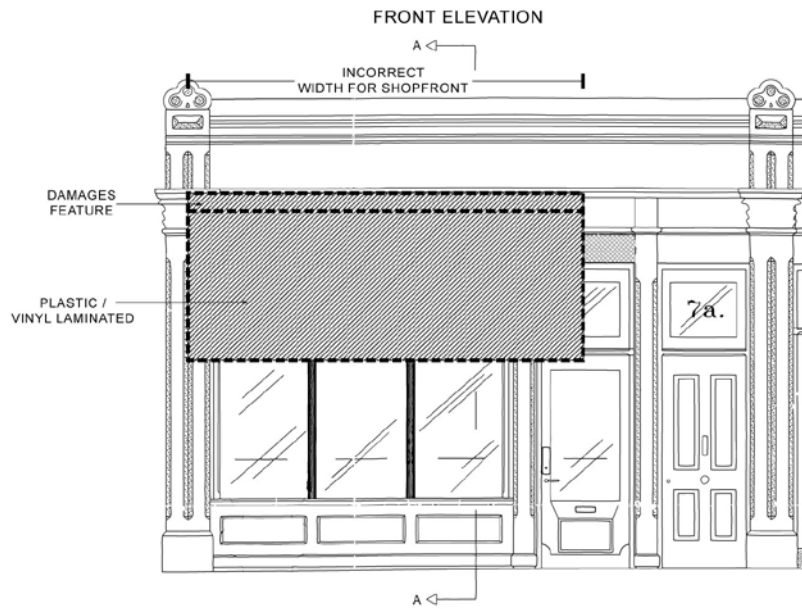
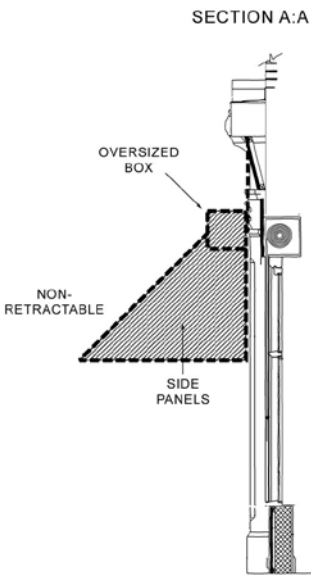
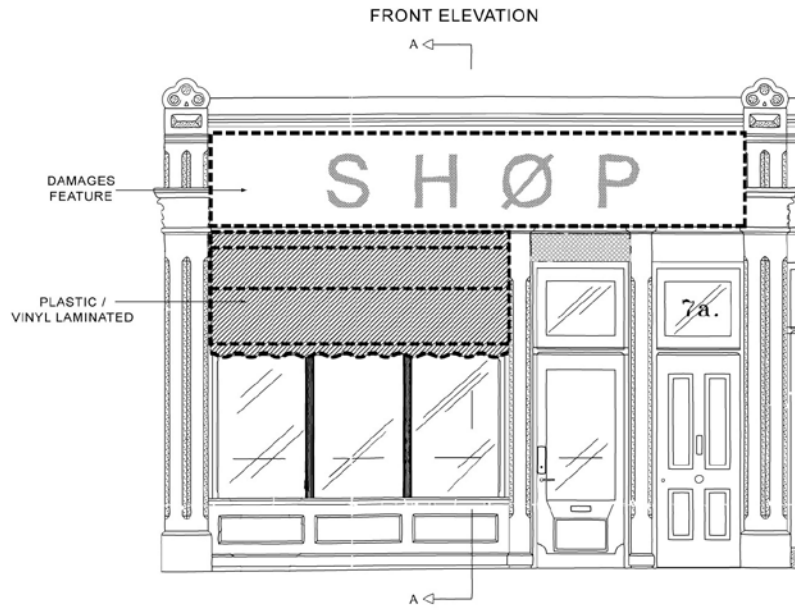
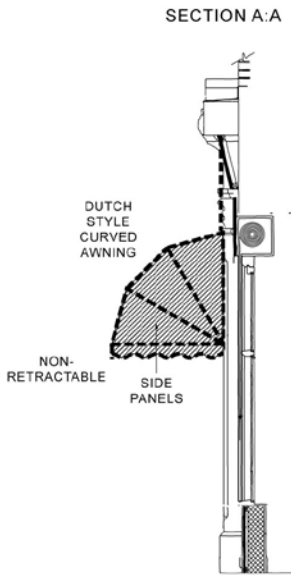

### **Retractable**

- 7.20 Retracting awnings and blinds do not normally require planning permission, although they may require advertisement consent in certain cases. They should not:
- obscure or damage the fascia and other important features of the shopfront and buildings;
  - have discordant and over-dominant shapes, but be appropriate in position, design and materials to the character and scale of both the shopfront, building and locality.

### **Fixed**

- 7.21 Fixed canopies, require planning permission. Acrylic / plastic “Dutch blinds”, or similarly reflective materials will be strongly discouraged, due to their bulk and materials and the resulting visual clutter.

### **Materials**

- 7.22 Canvas blinds are often characteristic features of historic shopfronts and should therefore be retained or replaced using a similar design – acrylic or plastic blinds are not normally suitable.

### **Signage**

- 7.23 Canopies or blinds with signage (a letter or words for advertising purposes or not), they are treated as advertisements and therefore advertisement consent will be required rather than planning permission (See chapter 8 ‘Advertisements, signs and hoardings’ in this CPG).
- 7.24 In general all blinds should be designed and installed to:
- ensure public safety;
  - incorporate a minimum of 2.3 metres between the bottom of the blind and the pavement; and
  - incorporate a minimum of 1 metre between the blind and the kerb edge.

### **Shopfront security**

- 7.25 Security shutters can be visually unattractive and create a 'dead', hostile appearance (especially out of opening hours), which can affect the commercial viability of an area and harm the pedestrian experience.
- 7.26 These guidelines offer suggest the most appropriate means of providing security protection while minimising impacts on the appearance of the shopfront, the building and the character of the area.

### **Shutters**

- 7.27 The Council strongly encourages internal rather than external shopfront security measures. Other forms of enhanced shopfront security should

be considered instead of external shutters. For example, improved internal lighting, alarm systems, the use of toughened or laminated glass, etc. In cases where external measures (shutters, grilles or alarm boxes, etc) are proposed they would only be permitted where they do not harm the character of shopfronts, such as internal brick bond grilles or collapsible gates.

- 7.28 External security shutters will normally require planning permission, whilst internal shutters normally do not. Where internal shutters are installed they should be set back to leave a window display. In the case of listed buildings, the installation of any shopfront security measures, external or internal, will require listed building consent. On listed buildings, there will be a presumption against the use of external security shutters and grilles in favour of internal.
- 7.29 Where an external shutter is proposed it may only be considered acceptable provided it is integrated into the shopfront in terms of design, materials and colour. External measures should avoid using solid roller shutters. This includes the 'pin-hole' versions that rely upon internal illumination for any transparent effect. These designs have negative environmental impacts including:
- obscuring the shopfront and hiding window displays;
  - attracting graffiti;
  - preventing natural surveillance;
  - creating a hostile and unsafe appearance in streets and shopping centres; and
  - being visually unattractive.

### **Shutter boxes**

- 7.30 Shutter boxes should be discrete and should not project forward of the fascia or obscure any architectural features. They should be concealed wherever possible, for example set behind or within the fascia panel, the guide rails concealed within the frame of the shopfront and shutter should be close onto the stallriser.

### **Grilles**

- 7.31 Roller grilles are preferable to solid or pin-hole shutters as they provide security without obscuring window displays and allow views of the shop interior, which enhances surveillance and security.

### **Removable grilles**

- 7.32 Removable or collapsible grilles can be used internally or externally and in both cases allow a certain degree of visibility. These only require planning permission if installed externally. However, listed building consent will also be required for internal grilles in listed buildings.
- 7.33 Removable grilles are expected to remain in place only outside trading hours and should be stored inside at all other times. Any fixings should

be discretely placed and must not harm architectural features or mouldings.

- 7.34 Where there is a recessed entrance it is preferable to install 'Concertina style gate between the openings.

### **Finishes**

- 7.35 All grilles and shutters should have an acceptable finish. They should be coloured (painted, powder coated or stove enamelled) to match the rest of the shopfront, including signs. Uncoated shutters, galvanised steel, a milled finish or anodised aluminium are not considered acceptable finishes. In the exceptional cases where solid shutters are acceptable, original designs by artists will be encouraged provided they respect their location, particularly in Conservation Areas.

### **Burglar Alarms**

- 7.36 Burglar alarm devices must be sited so that they are both adequately visible as a deterrent but do not detract from the visual character of the shopfront.

### **Cash machines**

- 7.37 Cash machines require planning permission and, in the case of listed buildings, listed building consent. Illuminated advertising for cash machines should be discreet and is subject to advertisement consent.
- 7.38 Cash machines (also known as cash points and ATMs) are only likely to be acceptable provided they are:
- treated as an integral part of a building's design wherever possible;
  - not dominant in the shop display frontage in terms of size or materials;
  - positioned sensitively and not be located where queuing could cause problems;
  - with minimal amount of display material;
  - located on the busiest elevation of a building to reduce the risk of robbery;
  - fully accessible to disabled people in both location and detailed arrangement; and
  - in existing bank buildings of traditional design they are most successfully inserted into existing stone recesses or beneath window bays.

### **Further information**

- 7.39 English Heritage has also prepared guidance on heritage assets within:
- English Heritage – ‘Easy Access to Historic Buildings’ 2012 - [www.english-heritage.org.uk](http://www.english-heritage.org.uk)
  - English Heritage – ‘Easy Access to Historic Landscapes 2013 - [www.english-heritage.org.uk](http://www.english-heritage.org.uk)
- 7.40 For further guidance on how to make shopfronts more accessible to all users as well as disabled users, see:
- The Disability Rights Commission publication “Making access to goods and services easier for disabled customers: A practical guide for businesses and other small service providers
  - BS 8300:2009+A1:2010 ‘Design of buildings and their approaches to meet the needs of disabled people’ – Code of Practice’ (BSI)
  - Inclusive Mobility – A guide to best practice on Access to Pedestrian and Transport Infrastructure, 2005 (Dept for Transport).





## 8 Advertisements, signs and hoardings

### KEY MESSAGES

In general, the most satisfactory advertisements are those which take into account:

- the character and design of the property;
- the appearance of the surroundings; and
- the external fabric of the building.

- 8.1 The purpose of this guidance is to provide advice on the design and siting of advertisements so that they contribute positively to the appearance and character of an area. All advertisements affect the appearance of the building, structure or place where they are displayed, to the extent that they can sometimes be the most dominant feature in an urban setting.
- 8.2 This guidance relates to Core Strategy Policy CS14 Promoting high quality places and conserving our heritage and Development Policies DP24 Securing high quality design and DP30 Shopfronts.
- 8.3 This guidance applies to all advertisements requiring advertisement consent, i.e. those which do not have “deemed consent” under the regulations.

### DEEMED CONSENT

This allows the display of certain "specified classes" of advertisement without first having to make an application to the local planning authority

- 8.4 Guidance on advertisements is also contained within Outdoor advertisements and signs: A guide for advertisers (CLG, 2007, [www.communities.gov.uk/publications/planningandbuilding/outdooradvertisements](http://www.communities.gov.uk/publications/planningandbuilding/outdooradvertisements)). Where advertisements have deemed consent and do not require formal advertisement consent the guidance in this document should still be applied as a matter of good practice. Reference should also be made to chapter 7 Shopfronts, in this guidance, and the Fact Sheet on Estate agent boards.

### What advertisements and signs are acceptable?

- 8.5 Good quality advertisements respect the architectural features of the host building and the character and appearance of the surrounding area. As a general guide, the most satisfactory advertisements are those which take into account the character and design of the property, its surroundings and alter the external fabric of the building as little as possible.

### All advertisements

- 8.6 Advertisements and signs should respect the form, fabric, design and scale of the host building and setting. All signs should serve as an

integral part of the immediate surroundings and be constructed of materials that are sympathetic to the host building and the surrounding area. Interesting and unique styles of advertisements and signs will be considered acceptable where they are compatible with the host buildings and surrounding environment.

- 8.7 Generally advertisements will only be acceptable at fascia level or below. Advertisements above fascia level can appear visually obtrusive and unattractive and, where illuminated, they can cause light pollution to neighbouring residential properties. If an advertisement is required at high level for a specific business use then this will usually be restricted to non illuminated images on windows.

**Fascia**

Runs horizontally across the ends of the roof rafters, below the lower edge of the roof.

- 8.8 Advertisements will not be considered acceptable where they impact upon public safety, such as being hazardous to vehicular traffic (e.g. block sight lines, emit glare) or pedestrian traffic (e.g. disrupt the free flow of pedestrian movement).
- 8.9 Advertisements in conservation areas and on or near listed buildings require detailed consideration given the sensitivity and historic nature of these areas or buildings. Any advertisements on or near a listed building or in a conservation area must not harm their character and appearance and must not obscure or damage specific architectural features of buildings.

**Advertising on street furniture**

**Street furniture**

A collective term for objects on streets and roads, including benches, bollards, post boxes, phone boxes, streetlamps, traffic lights, traffic signs, bus stops etc

- 8.10 Free standing signs and signs on street furniture will not normally be accepted where they contribute to visual and physical clutter and create a hindrance to movement along the pavement or pedestrian footway.

**Illumination**

- 8.11 The illumination levels of advertisements should be in accordance with the standards set by the Institute of Lighting Engineers Technical Report Number 5 (Second Edition).
- 8.12 The type and appearance of illuminated signs should be sympathetic to the design of the building on which it is located. The method of illumination (internal, external, lettering, neon, etc) should be determined by the design of the building. Illuminated signs should not be flashing or intermittent, whether internal or external.

- 8.13 Externally illuminated signs should be unobtrusively sized and sited. Spotlights and trough lights should be fixed and sized as discreetly as possible. Corporate designs involving internally illuminated signs may need to be modified where they are considered unsuitable, especially in residential areas, or conservation areas, or on listed buildings.

**Trough lighting**

An enclosed sign lighting unit using high powered fluorescent tubes.

- 8.14 To ensure that an advertisement does not become unduly dominant in the streetscene, disturb adjoining residents at night, or cause safety hazards to drivers, consideration should be given to the:

- intensity of illumination;
- surface area to be illuminated; and
- positioning and colours.

- 8.15 Internally illuminated box signs are discouraged. Generally, the internal illumination of individual letters, rather than the whole fascia or projecting sign on a shopfront, will be more appropriate.

### **Hoardings**

**Hoarding**

A billboard or large outdoor signboard.

- 8.16 Where advertisement consent is required for the display of hoardings, the following guidance will be applicable:
- 8.17 Advertisement hoardings or posters will not usually be acceptable in predominantly residential areas and will be carefully controlled in conservation areas and on or near listed buildings to ensure that they do not detract from the area's and building's character and appearance. However, if an area has a mix of uses or is predominantly in commercial use some poster or hoarding advertising may be acceptable where they satisfactorily relate to the scale of the host building or feature and its surroundings. They should be designed and positioned as an integral feature of the building. Some guidelines on when hoardings will not be considered acceptable include:
- in locations where they may prevent or significantly damage views or obscure light;
  - where they are forward of the face of adjoining buildings;
  - where they project above roof ridge/eaves level;
  - where they obscure architectural features or landmarks (including windows or window recesses); and
  - on side walls where they would be unduly dominant.
- 8.18 Temporary poster hoardings used to screen buildings or construction sites while work is being carried out have deemed consent under the 2007 Regulations (please refer to Class 8 in the regulations for specific

details) for commercial, industrial or business uses only. This deemed consent is not available for any residential development and is also not available in conservation areas.

- 8.19 The impact of illumination will be taken into consideration and where it is considered to be a nuisance or out of character with the area then it will not be considered acceptable.

### **Shroud / banner advertisements**

#### **Shroud advertisement**

Large scale advert, covering an entire building elevation, often used to shield construction work.

- 8.20 Shroud advertisements come in a range of forms but are generally large-scale and can cover the entire elevation of a building. As a result of the scale and size of shroud advertisements their appearance can create a conflict with the surrounding environment and the streetscene and, where the advertisement partially obscures a building, the visual appearance of the building itself. However, they can help to shield unsightly construction work.
- 8.21 Conservation areas and listed buildings are particularly sensitive to these types of advertisements as they can appear overwhelming, and disrupt the appearance of a high quality built environment. Therefore, given the scale and size of shroud advertisements these types of advertisement proposals will only be considered acceptable primarily in commercial areas and only where they screen buildings under construction, alteration or refurbishment. If considered acceptable they will be allowed for a temporary period and should be removed on completion of the works should they be sooner than the approved period. Longer consents will require additional advertisement consent.
- 8.22 Shroud on scaffolding will only be permitted where:
- The scaffolding covers the entire elevation of the building and the netting on the scaffolding contains a 1:1 image of the completed building which is undergoing construction work (scaffolding is only to be erected for the purposes of carrying out building works and will be removed upon completion of the works); and
  - The advertisement covers no more than 20% of each elevation and is not fragmented. The advertisement must also respect the architectural form and scale of the host building. Where shroud and banner advertisements are considered acceptable on listed buildings or in conservation areas the advertisement should not cover more than 10% of each elevation and should not be fragmented. The location of the advertisement on the shroud will depend on the character of the local built form and the nature of views within it.
  - In some highly sensitive locations or where the building plays a particularly important role in the appearance of the area, a visual representation of the building that is shrouded may be considered necessary to mitigate any harm to the appearance of the area.

8.23 Banner advertisements on buildings will only be permitted where:

- They relate to landmark or unique buildings, such as festival venues, museums, and do not detract from the appearance and form of the host building or the surrounding environment.
- In some commercial areas flags or banners may be considered a suitable form of display. Within residential areas, conservation areas, and on or near listed buildings we will be primarily concerned with safeguarding the amenity, character and appearance of these areas and buildings and therefore it is unlikely that such advertisements will be supported.

8.24 NB: The erection of a banner or shroud advertisement may require a specific licence from our Highways Management Team. If advertisement consent is granted for a banner or shroud, this does not indicate that a licence will also be granted. The Highways Management Team should be contacted for more information. For information on licences please contact the Camden Highways Management Team.





## 9 Designing safer environments

### KEY MESSAGES

- You should demonstrate that all impacts of your proposal on crime and safety have been considered;
- Security features should be considered early in the design process.
- Designing out crime features should complement other design considerations.

- 9.1 Good design, where due consideration is given to community safety, can create safe and attractive places to live and work and also prevent the need for security measures which can be expensive, unattractive and reactive in nature.
- 9.2 The aim of this guidance is to ensure that development contributes towards breaking down the link between the built environment and crime and anti-social behaviour (ASB), wherever possible, by ensuring that all developments consider and address any impact on crime and the perceptions of crime that may arise.
- 9.3 This guidance relates to Core Strategy policy CS17 Making Camden a safer place, and Development Policy DP24 Securing high quality design.
- 9.4 This guidance applies to all planning applications that will result in a physical alteration to the built environment that may have an impact on crime, anti-social behaviour or community safety.

### How can I design safer environments?

#### General principles

- 9.5 In accordance with Core Strategy policy CS17 Making Camden a safer place, we will require applicants to demonstrate that all impacts of their proposal on crime and community safety have been considered and addressed. Applicants should be able to demonstrate that they have consulted the Police Crime Prevention Design Adviser (details of which can be found at [www.securedbydesign.com](http://www.securedbydesign.com) and that proposals take into account the advice given, where appropriate.

#### Police Crime Prevention Design Officer

Can provide professional risk management advice, at the design stage, on all aspects of security of a development.

#### Urban design

Urban design is concerned with improving the quality, appearance and functionality of places, particularly the public realm. It works on a scale larger than architecture and smaller than town planning.

**Designing out crime**

A method of minimising crime by designing or organising the environment in such a way that the opportunity for crime is reduced and potential offenders feel exposed and uncomfortable.

9.6 Good urban design will significantly reduce opportunities for crime and anti social behaviour. Security features should be considered early in the design process as it can be more difficult to incorporate features in a sensitive way at a later stage. It is important to take a proactive approach at an early stage to reduce risks and opportunities for crime and ASB to occur, rather than relying on reactive measures such as CCTV, which should be used as part of a package of measures to reduce crime. Incorporating designing out crime features into a development should complement other key design considerations. High quality architecture and design should still be achieved.

9.7 You should consider:

- good urban design principles, including active frontages to buildings and interesting and innovative design treatments that can reduce the need for physical barriers;
- using a local assessment of design to ensure that places are both well connected and secure;
- the effect of designing against crime on properties adjacent to and in the vicinity of a development, and the personal safety of people who will use the locality; and
- avoiding a 'fortress approach' as it tends to be unattractive and can result in an oppressive environment for both residents and passing pedestrians.

**Active frontage**

Building frontages which add interest and life to public spaces, through the use of doors and windows or shopfronts and lively uses.

9.8 We expect developments to reflect the considerations contained within the publication Safer Places – The Planning System and Crime Prevention (ODPM April 2004). This identifies seven attributes of sustainable communities that are particularly relevant to crime prevention. Therefore, we expect the following elements to be considered in planning proposals:

Access and movement	to, from and within any development
Structure	layout, type and design of buildings, and of public space
Surveillance	maximisation of overlooking, lighting, the promotion of active frontages and through the introduction of crime prevention measures
Ownership	clear delineation between public, communal, semi-private and private space
Physical protection	strengthening of the security of building in order to reduce or minimising the risk of attack or theft
Activity	compatible mix of uses and attractiveness and sustainability of any public realm components
Management and maintenance	inclusion of details of management and maintenance systems where appropriate

- 9.9 We require a crime impact assessment as part of the Design Statement to be included with all applications of 10 residential units or more or for sites of 1000 sq m or more. This should demonstrate that any impact on crime and antisocial behaviour has been considered, addressed and where appropriate designed out. For smaller schemes it will be expected that designing against crime principles will be incorporated into the scheme. These designing against crime principles are set out in Safer Places: The Planning System and Crime Prevention, ODPM, 2004.

**Design Statement:**

Documents that explain the design thinking behind a planning application. They should show that you have thought carefully about how everyone will be able to use the places you want to build.

### Addressing Community Safety Concerns

- 9.10 To enhance community safety, we would like to see developments consider:
- maximising accessibility by encouraging usage of safe routes to, from and through developments;
  - the design and layout of pedestrian, cycle and vehicular routes into and within the site, including how these integrate with existing patterns; and
  - lighting and the use of CCTV where appropriate, accessibility and ease of movement through a development scheme, which can enhance overlooking, thereby reducing the opportunity for crime and anti-social behaviour and increasing perceptions of personal safety.

### Movement and Gating

- 9.11 Gating can be seen as a solution to problems of crime and anti social behaviour. Gating and other ways of restricting access to developments

can have a divisive effect on communities, creating separate residential areas and often necessitating long alternative routes. It can create and reinforce negative perceptions of an area and for these reasons gating should be seen as a last resort.

- 9.12 We expect that developments will demonstrate the accepted principles of good urban design as laid out by the Commission for Architecture and the Built Environment (CABE) in 'By Design', a companion guide to Planning Policy Statement 1, which sets out the 7 objectives of urban design. One of these that is particularly relevant to movement and gating is "Ease of movement – a place that is easy to get to and move through. To promote accessibility and local permeability by making places that connect with each other and are easy to move through, putting people before traffic and integrating land use and transport."
- 9.13 We will not support applications for restricting access to, from or gating of, the public highway or designated open spaces that are currently accessible to the public. All applications which seek to reduce access to, from or through the public spaces will need to:
- explain clearly the rationale for the reduction in access and be able to demonstrate that it is an appropriate solution, which minimises negative impacts in, adjacent to and in the vicinity of the development;
  - provide evidence of anti-social behaviour and crime to support the proposed restricted access; and
  - demonstrate the alternative steps they have taken to address the problems.
- 9.14 We will consider whether the proposed restriction will:
- have an adverse impact on accessibility in the local area by reducing the opportunity for local people to use established routes. For further information refer to CPG4 Protecting and improving the quality of life (Access for all chapter);
  - result in the loss of natural surveillance by neighbours and passers-by thereby increasing the opportunity for crime and anti-social behaviour;
  - necessitate long alternative routes to take account of the proposed restriction;
  - have an adverse impact on the community cohesion and security of the local environment by creating separate residential areas;
  - have an unacceptable adverse impact on the safety or perception of safety adjacent to and in the vicinity of the development;
  - prevent the type of anti-social behaviour crime evidenced by the applicant; and
  - prevent unauthorised entry into the development.
- 9.15 In all cases we will consider time limiting permissions for gating, thereby allowing flexibility should any incidents of crime and anti-social behaviour decrease.

- 9.16 Rather than gating we wish to see developments enhance community safety by maximising accessibility through encouraging the usage of routes to, from and through development. Good design, lighting, the use of CCTV where appropriate and public accessibility can reduce the opportunity for crime and anti-social behaviour.

### **Licensed premises and alcohol related violence**

- 9.17 Licensed premises, because of their nature can be the location of alcohol related violence. This can be limited by good design, employing open layouts and maximising natural surveillance where possible. Where an application is received for alterations to new or existing licensed premises, we will seek to:

- maximise visibility into the premises by ensuring, where possible, clear glass is used on all street elevations; and
- reduce the number of entry points to a minimum.

### **Recesses**

<p><b>Recesses</b></p>
------------------------

<p>Set-backs in the line of building frontages.</p>
---

- 9.18 Recesses, including recessed doorways, can provide the opportunity for anti-social behaviour and can have an impact on crime and the perception of crime.
- 9.19 In consultation with our Building Control Service and the Fire Authority, opportunities can be taken to reduce the number of emergency exit doors within recesses or minimise their impact. Bringing the doors forward should be investigated when schemes are being designed, by:
- allowing the doors to open inwards, where there are 60 users or less of emergency exit doors and it is not a licensed premises;
  - allowing the door to continue to open outwards if there is a private forecourt which it can open onto. Measures must be put in place to divert pedestrians away from the opening arc of the doors; and
  - allowing for the outward opening of the door where there are 60 or more users and the footway is very wide.
- 9.20 Where bringing the doors forward is deemed unacceptable, it should be ensured that:
- the recess is no deeper than 600mm or no greater than required for the opening of the door within the recess;
  - the edges of the recess are angled to improve visibility;
  - transparent elements are incorporated into the door;
  - the recess is widened so that it does not create hidden spaces; and
  - where appropriate and if the building is unoccupied for periods of time, open-weave grille shutters or collapsible gates are installed, to be opened when the building is occupied.

- 9.21 In all circumstances, overlooking of the recess should be maximised where possible by considering replacing the emergency exit door with an all glazed or top half glazed door with thick laminated glass. An open weave grille can be installed internally for additional security. Further guidance is contained within chapter 7 Shopfronts, in this guidance.

### **Walls and fences**

- 9.22 Careful consideration should be given to walls and fences, or other boundary treatments. If boundary walls are used in certain locations, where anti-social behaviour is identified as a problem, they should not have a flat horizontal top, which is inviting to sit on. Angled tops could be used to avoid the wall being used as an informal seat. Further guidance is contained within chapter 6 Landscape design and trees, in this guidance.

### **Public realm and street furniture**

#### **Street furniture**

A collective term for objects and pieces of equipment installed on streets and roads, including benches, bollards, post boxes, phone boxes, streetlamps, traffic lights, traffic signs, bus stops etc

- 9.23 Well designed street furniture and public art in streets and public places can contribute to a safe and distinctive urban environment. Street furniture should not obstruct pedestrian views or movement or be positioned to encourage anti social behaviour.
- 9.24 All features within public space and elements of street furniture should be designed to make a positive contribution to community safety and discourage anti-social behaviour. Careful consideration should therefore be given to their location and detailed design.

### **Cash machine boxes**

- 9.25 Cash Machine boxes are stand-alone structures located on the footway, which house Automatic Teller Machines (ATMs). We will refuse the siting of these in areas of high crime. Permission will only be granted where the police designing out crime advisors believe that it would not act encourage crime or interrupt important sightlines. Where they are allowed, the design should ensure maximum visibility into and through the proposed structure. Please see chapter 7 Shopfronts, in this guidance for further information.

### **Telephone boxes**

- 9.26 Although we have only limited and discretionary control over the siting and appearance of public call boxes, we are consulted on the siting of new telephone boxes on the public highway. In all cases we will request that the provider demonstrates the need for the siting of the new facility. In certain areas of the Borough, public call boxes can be seen as crime generators and in these areas we will consider whether the proposed location will have an impact on crime levels.

- 9.27 All new phone boxes should have a limited impact on the sightlines of the footway. The size of the box or other supporting structure that the phone box is in should be minimised to limit its impact on the streetscene and to decrease the opportunities for crime and anti-social behaviour. There should be a minimum footway width of 2m adjacent to the phone box. Designs which are dominated by advertising space are not acceptable. Any advertising should not be placed where it significantly reduces natural surveillance or CCTV coverage of, or into, the call box. Designs should seek to maximise views into and through the phone box and along the footway.

### Lighting

- 9.28 Good lighting can have a number of benefits, including:
- enhancing the built environment by increasing the potential for natural surveillance;
  - reducing the opportunity for criminal activity to take place;
  - where crime does occur, increasing the likelihood of it being challenged and/or reported; and
  - ensuring that CCTV footage is of sufficient quality to assist in the detection of crime.
- 9.29 Where used inappropriately, however, it can result in light pollution which is intrusive and can have an impact on residential amenity. It can also result in pooling of light which means that pedestrians walk from areas well lit to those with little light. This impacts on their perceptions of their own safety and can influence the way in which they use their environment.
- 9.30 We will seek to encourage good quality lighting provision in all developments to use metal halide lamps or the equivalent and high quality refractors where appropriate to maximise the perception of colour and increase the controllability of where light falls. This will encourage uniformity of light provision. Uniformity of light is very important in people's perception of how well an environment is lit and has a greater impact than absolute lighting levels. It is also necessary for people with sight impairments, whose eyes adjust to different light levels more slowly than fully sighted people. Lighting should be designed so as to minimise glare and reflection problems.

#### **Metal halide lamp**

A type of light source used in a variety of applications which produces a large amount of quality light without being a huge, bulky light bulb.

- 9.31 Where lighting is provided to increase on-site security, this should not have an adverse effect on the perception of lighting levels in areas adjacent to the site and where possible should enhance this provision.
- 9.32 Mounting of lighting should be considered to ensure that it is resistant to vandalism and does not act as a climbing aid.



### Landscaping

- 9.33 Where landscaping is created it can be important to consider sightlines as the landscaping matures. There may be a requirement for a maintenance agreement to ensure that planting as it matures does not impact on sightlines or CCTV coverage.

### Maintenance

- 9.34 How an area is maintained can have a major impact on people's perceptions of crime and anti-social behaviour. Where a development creates public space we may seek to agree a management and maintenance plan with the applicant.

### Car parks

- 9.35 Applications for car parks should demonstrate that they are well lit and secured in order to discourage anti-social behaviour. Underground car parks in particular should be securely designed and access limited to users.

### Anti-terrorism

- 9.36 Terrorism can pose a very real threat in some areas of the borough. It is beyond the scope of this document to deal with these threats in detail but we will work with counter terrorism security advisors (CTSAs) on a case by case basis. Where appropriate the principles of the Government guidance, *Crowded Places: The Planning System and Counter-Terrorism* should be applied.

### Conservation Areas and Listed Buildings

- 9.37 Incorporating designing out crime features into a development should complement other key design considerations such as the character and appearance of conservation areas and listed buildings. Measures for designing out crime will require careful consideration in these often more sensitive settings and some may not be considered appropriate within conservation areas or within the setting of a listed building. In these cases imagination should be used to come to a sensitive alternative solution.

### Design and access statements

- 9.38 In situations where crime and anti-social behaviour is a concern, applicants should demonstrate within Design and Access Statements their understanding of the local issues relating to crime, and how the design will address them. In these situations, Design and Access statements should outline:
- Current levels of crime and anti-social behaviour in the immediate area;
  - Activity levels in the streets and public spaces at all times of the day and night;

- The extent of natural surveillance of neighbouring properties, streets and public spaces; and
- Any other relevant local characteristics.

### **Further information**

9.39 For further guidance on designing against crime:

- Safer Places: The Planning System and Crime Prevention, ODPM, 2004.



## 10 Recycling and Waste Storage

### KEY MESSAGES

Planning for waste recycling and storage should ensure that developments accommodate:

- adequate space (designed) for the storage of recyclables and waste;
- safe location - accessible for all users and collectors and minimise nuisance to occupiers and neighbours (and their amenity space) e.g. noise, obstruction, odours, pests, etc.;
- recycling and refuse collection for any waste contractor (and allow for reasonable changes to collection services in the future);
- containers should have designated storage areas; and
- sensitively designed/located, especially in conservation areas/or listed buildings.

- 10.1 This section seeks to ensure that appropriate storage for recyclables and waste is provided in all developments in Camden. Its key aim is to assist those involved in the design and management of buildings to best provide for the storage of waste and maximise the amount that can be sent for recycling.
- 10.2 This guidance relates to Core Strategy Policy – CS18 - Dealing with our waste and encouraging recycling and Development Plan Policies - DP26 – Managing the impact of development on occupiers and neighbours and DP22 – promoting sustainable design and construction.
- 10.3 This guidance also relates to the British Standard BS5906-2005 – Waste management in buildings – Code of practice.
- 10.4 The following section provides detailed guidance on the space requirements for both internal and external storage features. It covers residential developments of 6 or fewer dwellings, residential developments of more than 6 dwellings, and non-residential or commercial dwellings.
- 10.5 This guidance applies to:
- all new build developments;
  - developments that significantly increases amount of floor space and on-site waste; and
  - other activities that significantly increase the amount of waste generated on-site.
- 10.6 This guidance does not cover construction and demolition waste, or hazardous waste. For further information on these topics please refer to CPG4 Sustainability, particularly the chapter Sustainable use of Materials and Hazardous substances and Construction Management Plans.

## Guidance on standards for waste storage

- 10.7 This section provides detailed guidance on the requirements for both internal and external recycling and waste facilities to ensure designs allow sufficient space for the storage of recyclable material and waste in developments. To encourage occupants to recycle, internal storage areas should be designed into each unit of a new development. This will enable occupants to segregate their waste into refuse and recyclables, and store it temporarily, until it can be transferred to external bins.

### Residential development of 6 dwellings or fewer

#### Space requirements

- 10.8 Residential development of 6 dwellings or fewer are usually serviced by a kerbside recyclables and waste collection. The designs for recycling and waste facilities need to provide sufficient internal and external storage areas for each unit, ensuring:
- that internal space is provided for recycling and refuse storage, comprising adequate space for a recycling receptacle (typically a green reusable box or bag), food waste caddy, and waste bin for non-recyclables. Kitchens and utility rooms are generally the most appropriate locations;
  - there is external storage for mixed (commingled) recyclables, organic kitchen waste and non-recyclable waste, providing space for the following:
    - a free-standing 140l or 240l wheelie bin for the storage of commingled recycling;
    - a free-standing kitchen waste caddy;
    - seasonal storage of garden waste i.e. in large hessian sacks;
    - a free-standing receptacle for the storage of refuse (should the developer or resident wish to purchase one, as the Council does not currently provide containers for refuse);
    - for details of container dimensions please see Figure 13, below.

### Residential development of 7 dwellings or more

- 10.9 Collection services for developments with 7 or more residential dwellings vary depending on the individual circumstances of the premises. For this type of development a kerbside collection is preferred, where possible. For external storage requirements, the guidance for residential development of 6 or fewer units should be used.
- 10.10 Where communal facilities are required (i.e. the dwellings will share central recycling and refuse bins), the following steps should be followed:
- 10.11 The table below can be used to calculate the total volume of all waste and recycling generated in a week:

Size of household	Number in development	Projected Weekly Waste per household	Waste produced from all households
Studio / one bedroom	A	100 litres	A x 100 = W litres
Two bedroom	B	170 litres	B x 170 = X litres
Three bedroom	C	240 litres	C x 240 = Y litres
Total Weekly Waste Arising			W+X+Y = Z litres

- 10.12 If there are more than six households in a block of flats we recommend the use of bulk bins. The standard Eurobins we use have a capacity of 1,100 or 1,280 litres. The minimum required can be calculated as below:

$$\text{Number of bulk bins required} = \frac{\text{(Z) litres (from Table 1)}}{1,100 \text{ litres (volume of bulk bin)}}$$

- 10.13 Provision of bins should at least be split equally between refuse and recycling including provision for food waste – e.g. if a building requires 4.5 x 1,100l bins, 2 should be for refuse and 2 for dry recycling, plus a 660l bin for food waste.

#### Space requirements

- 10.14 Internal storage: Bulk bins must be placed on smooth impervious material that is 100 mm thick to withstand the weight. If multiple bins are needed they are better kept in an enclosure. This discourages non-residents from using the bins and also improves the aesthetics of the development. The dimensions of bulk bins are given in the table below.

**Figure 13. Storage containers and dimensions**

<b>Container Type</b>	<b>Use</b>	<b>External dimensions mm (H x W x D)</b>
55l green box	Storage of mixed dry recycling by households without space for a wheelie bin. Can be stored internally or externally, collected from the kerbside.	350 x 390 x 585
45l reusable green bag	Storage of mixed dry recycling by households without space for a wheelie bin. Can be stored internally or externally, collected from the kerbside	350 x 300 x 450
7l kitchen caddy	Internal storage of food waste. Contents are then transferred to a larger outdoor caddy or communal food waste bin.	252 x 252 x 229
23l kitchen caddy	External storage and collection of food waste by households with a kerbside collection	405 x 320 x 400
90l white sack	Seasonal external storage of compostable garden waste	450 x 450 x 450
140l wheelie bin	External storage and collection of mixed dry recycling by households with a kerbside collection.	1070 x 580 x 550
240l wheelie bin	External storage and collection of mixed dry recycling by households with a kerbside collection	1070 x 580 x 740
500l Eurobin	Communal external storage and collection of food recycling for households with communal collections	1145 x 1305 x 745
1100l Eurobin	Communal external storage and collection of mixed dry recycling and refuse for households with communal collections	1370 x 1260 x 990

(NB: This list, including the bin dimensions, is subject to change. It is only to be used for preliminary design purposes)

- 10.15 Residents should not be expected to carry their waste more than 30 metres in the horizontal distance from their front door to the bin store.
- 10.16 The enclosure or chamber should be large enough to allow clearance of 150 mm between each bin and the walls.
- 10.17 There should be space in front of the bins to allow residents to easily access the bins when depositing waste.
- 10.18 If multiple bins are used then there should be sufficient space to rotate the bins in between collections.



- 10.19 The walls should be made from an impervious, non-combustible material that ideally has a fire resistance of one hour when tested to BS 476-21.
- 10.20 If a gate or door is added to the enclosure or chamber it should be metal, hardwood or softwood clad with metal. Ideally it should have a fire resistance of 30 minutes when tested to BS 476-22. The door frame should allow clearance of 150 mm either side of the bin, when it is being pulled out for collection. The door frame should be rebated into the reveals of the opening. There should be a latch or clasp to hold the door open while the collection process takes place.
- 10.21 Arrangements should be made for the cleansing of the bin stores with water and disinfectant. A hose union tap should be installed for the water supply. Drainage should be by means of trapped gully connected to the foul sewer. The floor of the bin store area should have a suitable fall (no greater than 1:20) towards the drainage points.
- 10.22 If the chambers are inside the building they should have a light. The lighting should be a sealed bulkhead fitting ( housings rated to IP65 in BS EN 60529:1992).
- 10.23 Internal bin chambers should have appropriate passive ventilators to allow air flow and prevent unpleasant odours. The ventilation must be fly and vermin proofed and near to either the roof or floor, but away from the windows of dwellings.

#### **Access for collections**

- 10.24 Collectors should not have to cart a bulk bin more than 10 metres from the point of storage to the collection vehicle.
- 10.25 The gradient of any path that the bulk bins have to be moved on should ideally be no more than 1:20, with a width of at least 2 metres, and the surface should be smooth.
- 10.26 If the storage area is raised above the area where the collection vehicle parks, then a dropped kerb is needed to safely move the bin to level of the collection vehicle.
- 10.27 The roadway the vehicle parks on should be able to accommodate the weight and size of a 26 tonne vehicle.

#### **Non-residential and commercial buildings**

- 10.28 Occupiers of commercial premises are legally obliged to make an arrangement with either the Council or a licensed waste carrier for the collection of the waste produced from the premises.
- 10.29 The volume of waste generated and thus the number and type of containers that a commercial development requires is ultimately dependent on the use of the building. Further information can be found on the Council's website:  
<http://camden.gov.uk/ccm/content/environment/waste-and-recycling/commercial-waste/duty-of-care.en>

- 10.30 Where an extension or change of use to an existing property is proposed, this may result in the removal of existing container storage areas, typically, to the rear of a property. This may be acceptable provided that an alternative storage area is designated as part of the proposed development, in line with this guidance. For external storage requirements, Figure 14: External Storage Requirements should be used.

#### Space requirements

- Internal collection and storage points should always be considered for all types of waste to maximise the amount of recyclable material.
- External storage must be provided in most cases. As a guide, approximately one cubic metre storage space is required for every 300-500sq m of commercial space (includes both recyclable and non-recyclable waste). Storage space must be designed to accommodate bins to hold this amount of waste, separated, and should be designed in consultation with the waste collection contractor.
- Waste and recyclables from residential and commercial components of a development must be stored separately, but they should be stored using the same container type to facilitate ease of collection.
- For a summary of external waste storage requirements see Figure 14

#### RESTAURANTS AND FOOD WASTE

Special consideration must be given to the location and nature of external storage areas. The volume of waste generated is generally high and has a high biodegradable content, therefore can potentially cause nuisance from odour, visual blight, and through attraction of vermin and scavengers. Storage of such waste should be in solid receptacles which ameliorate negative environmental impacts

Since 1st January 2006 developments that generate food waste have had to comply with the requirements of the Animal By-Products Regulations 2005. The Regulations place controls on the collection, handling, transport, storage and disposal of animal by-products, which includes catering waste. This may have implications for the design of the building and the waste containers required. Further information on The Animal By-Products Regulations 2005 should be sought from DEFRA – [www.defra.gov.uk/animalh/by-prods/default.htm](http://www.defra.gov.uk/animalh/by-prods/default.htm)

#### Location Requirements

- 10.31 The table below summarises the key external storage requirements. In particular, the first six features apply to all developments regardless of size and type of units.

Figure 14. External storage requirements

	<b>External storage area features:</b>	<b>Less than 6 residential units</b>	<b>7 or more residential units</b>	<b>Non-residential (commercial) Development</b>
1	Should not be located near ground storey windows. They should be located within 10 metres of an external access.	✓	✓	✓
2	External storage areas and collection points must be as close as possible to, and preferably within 10 metres of, a place suitable for a collection vehicle to stop.	✓	✓	✓
3	Storage facilities must be at or near street level, and should be accessible via appropriately sized and graded ramps to allow bins to be wheeled to and from the collection point easily.	✓	✓	✓
4	Must be safe for users by being well lit and visible from public vantage points and nearby dwellings / tenancies.	✓	✓	✓
5	Should be unroofed, unless they are fully enclosed and secured (ideally inaccessible to animals).	✓	✓	✓
6	Should be accessible for collection purposes and not impede pedestrian or vehicular access on public thoroughfares or to and from buildings.	✓	✓	✓
7	Should be located as close to the front property boundary as possible, preferably behind the front boundary wall, without detracting from the street scene.		✓	
8	Consideration should be given to the: <ul style="list-style-type: none"> <li>• allocation of additional external storage space in the future, e.g. additional bins,</li> <li>• composting facilities - in residential development with a garden or landscaping,</li> <li>• provision of onsite storage for bulky waste (i.e. furniture) items and potential opportunities for re-use of these items.</li> </ul>		✓	
9	Should be in an enclosed chamber that can be accessed from outside the building.			✓
10	Large developments in areas that are deficient in recycling banks (“bring”) facilities will be expected to incorporate these facilities onsite for use by the general public - must be located in secure and easily accessible communal areas,		✓	✓

### Additional Requirements

- 10.32 Applicants must provide details of storage for waste and recyclables in a proposed development as part of their application. These should be shown on the plans or in the application documents, where possible, and will form part of the approval
- 10.33 For schemes that create 7 or more dwellings, or includes a non-residential component, the applicant must consult Camden's Planning Department prior to making an application to determine the best means of storage and collection for the development. A statement describing the proposed waste storage and collection arrangements should be provided with the application.
- 10.34 For large proposals, or for proposals with complex waste separation or collection arrangements, a management plan might be required as a condition of approval.
- 10.35 Consideration should also be given to materials and finishes, and lighting of waste enclosures, to ensure that they are safe and secure, and do not present a fire hazard. These are dealt with in the Building Regulations.

### Further information

Camden Street Environment Services	Applicants are advised to contact Camden Street Environment Services in the first instant prior to making an application to determine the appropriate means of storage and collection required for a proposal  Address: Roy Shaw Centre 3-5 Cressy Road London NW3 2ND 020 7974 6914/5 <a href="http://www.camden.gov.uk/waste">www.camden.gov.uk/waste</a>
Waste storage requirements	Waste Storage : A Guide for Developers of Commercial and Residential Premises in the London Borough of Camden, Camden Street Environment Services  BS 5906 2005 Waste management in buildings – Code of practice, British Standards
Assistance with the identification of an appropriate company to deal with recyclable waste from the proposed development	Waste recycling <a href="http://www.wasterecycling.org.uk">www.wasterecycling.org.uk</a>  For free environmental guidance for small and medium-sized enterprises, see Environment Agency (NetRegs) <a href="http://www.environment-agency.gov.uk/netregs/default.aspx">www.environment-agency.gov.uk/netregs/default.aspx</a>

# 11 Building services equipment

## KEY MESSAGES

Building services equipment should:

- be incorporated into development;
- have a minimal impact on the environment; and
- Should not harm occupant or neighbour amenity.

- 11.1 Building services equipment, whether it is used for heating and cooling, communications, power, plumbing, ventilation, access or security, if not considered appropriately, can cause significant visual blight and nuisance for neighbours.
- 11.2 The purpose of this guidance is to ensure that necessary building services equipment can be incorporated into development, while having minimal impacts on their environment. Impacts that are likely to require minimisation or mitigation include visual blight, light nuisance, noise nuisance and vibration, odour, and other environmental pollutants or nuisance.
- 11.3 This guidance relates to Camden Development Policy DP24 Securing high quality design, DP26 Managing the impact of development on occupiers and neighbours and DP28 Noise and vibration.
- 11.4 This guidance does not specifically apply to renewable energy installations, or telecommunications as they are considered in other guidance but principles may be the same. For further information see CPG3 Sustainability (Energy efficiency: existing buildings, Energy efficiency: new buildings and Renewable energy chapters) and PPG8: Telecommunications.

## How should building services equipment be treated?

### Design considerations

- 11.5 In new development, all building services equipment:
- must be integrated within the building or development structure;
  - must be incorporated into the external building design where, because of its nature, it cannot be integrated within the building; and
  - should not be a dominant feature of the building.
- 11.6 In refurbished development, plant and machinery should be accommodated within the building structure, or incorporated into the design of external modifications.
- 11.7 Other design considerations for building services equipment include:
- screening or other techniques to minimise the impacts of plant, machinery and ducting must, in themselves, not cause visual blight;

- plant and machinery on roofs should not be visible from the street, public vantage points or from immediately adjacent buildings;
- the design and materials used for plant, machinery and ducting, as well as for ancillary structures such as screening, where located on the exterior of the building, must be consistent with those of the building; and
- where possible, plant and machinery should be designed in such a way that does not lead to issues of safety and security.

### **Amenity**

- 11.8 Where ducting, plant or machinery are required on the outside of a building they must not obscure access to daylight and sunlight, or provide any nuisance for occupants of the development or adjacent buildings.
- 11.9 Plant and machinery with moving parts must be separated or insulated from occupants and neighbours who are likely to be sensitive to noise disturbance. Techniques to achieve this separation include the use of flexible ducting, or resilient mountings for structure-borne plant and machinery.
- 11.10 Where mechanical or passive ventilation is required to remove odour emissions, the release point for odours must be located above the roofline of the building and, where possible, adjacent buildings.

### **Sustainability**

- 11.11 Plant and machinery, particularly where located on roofs, must not preclude the installation of required onsite renewable energy facilities in the proposal. Consideration must also be given to the possibility of future renewable energy installations.

### **Conservation areas and listed buildings**

- 11.12 Special consideration should be given to the installation of plant, machinery and ducting on listed buildings and in conservation areas. Fewer external solutions are likely to be appropriate in these locations. Installations must be in keeping with the design and materials of the building. Listed building consent is likely to be required for works to a listed building.

### **Other considerations**

- Access to plant and machinery must be provided to allow for convenient and safe servicing and replacement of installations;
- Machinery must be properly installed and maintained to ensure that impacts are properly mitigated and the situation does not deteriorate over time with continued operation.
- Plant and machinery should be located as close as possible to their end use, e.g. boilers should be located near to the hot water or

heating users, to minimise use of ducting materials, loss of resource and visual blight.

- Disused plant, machinery and ducting must be removed from the exterior of buildings before replacements can be installed. Only in exceptional circumstances will these be allowed to remain.





## 12 Artworks, statues and memorials

### KEY MESSAGES

Applications for artworks, statues or memorials are only likely to be acceptable if they:

- meet the requirements of Camden's corporate guidance 'New statues, memorials and artworks in parks, open spaces and the public highway in Camden' and
- protect and enhance the local character and historic environment and contribute to a harmonious and balanced landscape design.

It may be inappropriate to site any artworks and memorials in some locations for contextual or historic reasons.

### Background

- 12.1 Camden is receiving an increasing number of applications for artworks, statues and memorials and there is a limited and reducing supply of suitable locations in the public realm and parks and gardens to accommodate new works. This guidance sets out the minimum requirements that Camden expects for applications for public art and all commemorative works including statues and memorials.

### Prior to submitting a planning application

- 12.2 Before applying for planning permission you should ensure your proposal meets the requirements of the corporate guidance, you should secure all the relevant permissions, and arrange sufficient funding including for ongoing maintenance. Details of this should be provided as part of your planning application.

### Corporate guidance

- 12.3 LB Camden has prepared corporate guidance entitled 'New statues, memorials and artworks in parks, open spaces and the public highway in Camden'. The guidance sets out what the council expects for artworks and memorials in the borough. The corporate guidance includes the following principles:
- **Site specificity and context:** The subject of an artwork, statue or memorial must have a clear historical or conceptual connection to the proposed location.
  - **20 year principle:** At least 20 years after the death of an individual or the date of the event should elapse before an artwork, statue or memorial is erected in commemoration.
  - **Protected areas:** Artworks, statues and memorials should not be sited in spaces which already have a high concentration of other artworks, statues or memorials. LB Camden Parks and Open Spaces have surveyed key artworks, statues and memorials across the borough

and identified areas where any further development of artworks, statues and memorials is unlikely to be appropriate. These have been identified in site survey documents for Council owned or managed land and also through mapping of the density (saturation) of artworks, statues and memorials across the entire borough. We are unlikely to grant permission for new artworks, statues or memorials where identified as inappropriate in site surveys or in areas mapped as having a high saturated or existing works.

- **Quality:** Statues and memorials must be of the highest quality, from an artist who has been selected through a robust and transparent selection process.

- 12.4 The Council will not grant planning permission for artworks, statues and memorials which are not generally in line with the corporate guidance.

### **Permissions and other legislation**

- 12.5 Prior to applying for planning permission you should you have all relevant permissions includes permission from the land owner and from leaseholders and managers of the land.

- 12.6 You should have regard to other legislation including:

- The Highways Act 1980: works affecting the public highway will require consent of the highway authority.
- Public Statues (Metropolis) Act 1854: Section 5 requires consent of the Secretary of State for Culture, Media and Sport, although this is generally provided as a matter of course if the scheme receives planning permission.
- The London Squares Preservation Act 1931 and Public Statues Act 1884 may be relevant to your proposal.

### **Funding**

- 12.7 You should ensure you have made arrangements for the ongoing maintenance of an artwork, statue or memorial. If the artwork, statue or memorial is on Council owned or managed land you are likely to be required to arrange funding to provide to the Council for maintenance of the work in perpetuity. If the work is on private land you are likely to have to be required to provide a maintenance plan as part of planning permission. You may be required to enter a legal agreement (such as s106 Agreement) to secure these measures.

### **Planning Permission**

#### **When is planning permission required?**

- 12.8 Depending on the size and location, construction or installation of an artwork or memorial may be constitute development under the Town and Country Planning Act 1990 and therefore require planning permission. Artworks or memorials which are outside or will materially alter the appearance of an area or building will generally require planning

permission. Any artworks or memorials on the interior of a building and which do not materially alter the outside appearance of the building are unlikely to require planning permission. If an artwork or memorial forms part of a larger development it should form part of the planning application for the entire scheme. Listed building consent will be required for any work to which affects the special architectural or historic character of a listed building or structure including internal or external alterations.

### **Assessment of applications for artworks and memorials**

- 12.9 Applications for planning permission for memorials and artworks will be assessed against the National Planning Policy Framework, Council's Local Development Framework (LDF) Core Strategy and Development Policies planning policy documents, the relevant Conservation Area Appraisal and Management Plan (if in a Conservation Area), and Camden Planning Guidance.

### **High quality design**

- 12.10 Core Strategy CS14 'Promoting high quality places and conserving our heritage' requires development to be of a high standard of design and respect local character. CS14 promotes high quality landscaping and works to streets and public spaces.
- 12.11 Core Strategy CS15 'Protecting and improving our parks and open spaces and encouraging biodiversity' states that Camden will protect and improve its parks and open spaces.
- 12.12 Development Policy DP24 'Securing high quality design' requires all development to be of the highest standard of design, and expects developments to consider the character, setting, context, form and scale of neighbouring buildings, the quality of materials used, natural features and landscaping. The policy encourages outstanding design in contemporary or traditional styles. The policy requires development to consider existing rhythms, symmetries and uniformities in the townscape, the compatibility of materials and their texture, tone and colour, the contribution of a design to views and vistas, and the wider historic environment and features.
- 12.13 This Camden Planning Guidance document sets out further design considerations, refer to page 7 for general guidance on design and refer to page 43 for guidance on landscape design and trees.

### **Conservation of heritage**

- 12.14 Core Strategy CS14 'Promoting high quality places and conserving our heritage' requires development to respect local character and requires development to preserve and enhance heritage assets including historic parks and gardens.
- 12.15 Development Policy DP25 'Conserving Camden's heritage' requires development take account of conservation area statements, appraisals

and management plans. Development will only be permitted within conservation areas which preserves and enhances the character and appearance of that area. The policy requires the preservation of trees and garden spaces which contribute to the character of the conservation area and protects parks and gardens of Special Historic Interest and London Squares.

- 12.16 If the artwork of memorial is in a Conservation Area you must refer to the relevant Conservation Area Appraisal and Management Plan which are available on [www.camden.gov.uk](http://www.camden.gov.uk).
- 12.17 This Camden Planning Guidance document sets out further heritage considerations, refer to page 13.

#### **Crime prevention through design**

- 12.18 Core Strategy CS17 'Making Camden a safer place' requires developments to demonstrate that they have incorporated design principles which contribute to community safety and security and promotes safer streets and public areas. This may include through design, lighting and management.
- 12.19 This Camden Planning Guidance document sets out further heritage considerations, refer to page 77.

#### **Further considerations for artworks and memorials**

- 12.20 In line with the LDF Core Strategy and Development Policies as summarised above new artworks and memorials will only be permitted where they preserve and enhance the character of the local area, historic environment and heritage assets. Further planning considerations of particular relevant to artworks, statues and memorials are set out below.

#### **Landscape design and over-saturation**

- 12.21 New artworks or memorials should only be sited where they contribute to a harmonious and balanced landscape design. Many of the public spaces in Camden particularly open spaces in Central London have limited opportunities for siting of new artworks or memorials. The existing and historic design of spaces must be respected and new structures should not be imposed where they would not complement or improve this existing landscape design. New artworks or memorials are unlikely to be acceptable in locations where there are a number of existing artworks or memorials. Siting of artworks and memorials should also take consideration of the corporate priority to keep the spaces free of clutter to allow unimpeded pedestrian access and for aesthetic considerations.

#### **Historic and thematic context**

- 12.22 Artworks and memorials will only be permitted where appropriate in terms of the history, context and purpose of a site. The history or context of a

space may make siting of artworks or memorials inappropriate even when it may be acceptable from design or aesthetic considerations. If a location (for example a garden or square) has been traditionally free from artworks or memorials the introduction of a piece can shift the emphasis and meaning of that space from being an open space in its own right to that of a landscaped setting for an artwork, statue or memorial. Due to the impact they have in changing the character of a space artworks, statues or memorials which form the centrepiece or focus to a space, particularly higher profile spaces such as Central London Squares are unlikely to be acceptable in all but exceptional circumstances (for example where there is overwhelming public support for a person or event of national importance). In line with the National Planning Policy Framework great weight will be given to the conservation of heritage assets and development leading to substantial harm to the significance of a designated heritage asset will be refused, unless it can be demonstrated that the substantial harm or loss is necessary to achieve substantial public benefits that outweigh that harm or loss.

### **Temporary artworks and memorials**

- 12.23 Temporary memorials provide a focus for community commemoration while being significantly less costly and time consuming to establish. Planning permission may still be required for temporary structures and you should contact to the Council at an early stage for advice.





## Index

Advertisements .....	77	Grilles (shopfront).....	73
Advertisements (shopfronts).....	67	Heritage .....	15
Alarms .....	74	Hoardings .....	79
Anti-social behaviour.....	83	Landscape design .....	49
Anti-terrorism .....	90	Licensed premises .....	87
Article 4 directions.....	18	Lighting .....	60
ATMs .....	<i>See</i> Cash Machines	Listed Buildings.....	20
Awnings .....	68	Mansard Roofs.....	42
Balconies.....	45	Paving of front gardens .....	55
Banner advertisements .....	80	Railings.....	57
Blinds.....	68	Rear extensions .....	<i>See</i> Extensions
Building services equipment....	101,	Rear gardens .....	<i>See</i> Gardens
<i>See</i> Services		Recycling .....	93
Canopies .....	68	Refuse .....	93
Cash machine boxes.....	88	Roller grilles .....	<i>See</i> Grilles
Cash machines .....	74	Roof alterations and extensions..	39
Community Safety.....	85	Roof dormers .....	41
Conservation area statements....	19	Roof lights.....	45
Conservation areas.....	16	Roofs .....	39
Conservatories.....	35	Section 211 .....	52
Crime Prevention .....	84	Shopfronts.....	61
Cross overs.....	55	Shroud advertisements.....	80
Design and Access Statements..	13	Shutters .....	72
Doors.....	31	Side extensions.....	<i>See</i> Extensions
Dormers.....	41	Signs (general).....	77
Extensions .....	29	Signs (shopfronts) .....	67
Extensions (rear).....	33	Solar panels .....	46
Extensions (side) .....	34	Street furniture .....	88
External alterations .....	30	Tall buildings.....	12
External pipework .....	32	Telephone boxes.....	88
Fascias .....	65	Terraces.....	45
Fences.....	57	Tree preservation orders .....	52
Front gardens .....	<i>See</i> Gardens	Trees .....	49
Gardens.....	54	Trees in Conservation Areas .....	52
Gardens (front).....	54	Walls.....	57
Gardens (rear, development in)..	36	Window Displays.....	64
Gating.....	85	Windows .....	30
Green roofs (in roof design).....	46		

Camden Planning Guidance

# Amenity

London Borough of Camden

CPG 6





## CPG6 Amenity

1	Introduction .....	5
2	Air quality .....	7
3	Contaminated land .....	15
4	Noise and vibration .....	19
5	Artificial light .....	25
6	Daylight and sunlight .....	31
7	Overlooking, privacy and outlook .....	37
8	Construction management plans .....	39
9	Access for all .....	45
10	Wind and micro-climate .....	53
11	Open space, outdoor sport and recreation facilities .....	59
12	Planning for healthy communities .....	79





# 1 Introduction

## What is Camden Planning Guidance?

- 1.1 We have prepared this guidance to support the policies in our Local Development Framework (LDF). It is therefore consistent with the Camden Core Strategy and Development Policies, and is a formal Supplementary Planning Document (SPD) which is an additional “material consideration” in planning decisions. This guidance will replace Camden Planning Guidance 2006, updating advice where appropriate and providing new guidance on matters introduced or strengthened in the LDF.
- 1.2 Camden Planning Guidance covers a range of topics (such as design, housing, sustainability and planning obligations) and all of sections should be read in conjunction with, and within the context of, Camden’s other LDF documents.

## Amenity in Camden

- 1.3 A key objective of the Camden Core Strategy is to sustainably manage growth so that it avoids harmful effects on the amenity of existing and future occupiers and to nearby properties.

## What does this guidance cover?

- 1.4 This guidance provides information on all types of amenity issues within the borough and includes the following sections:
  1. Air quality
  2. Contaminated land
  3. Noise and vibration
  4. Artificial light
  5. Daylight and sunlight
  6. Overlooking, privacy and outlook
  7. Construction management plans
  8. Access for all
  9. Wind and micro-climate
  10. Open space, outdoor sport and recreation facilities

- 1.5 This guidance supports the following Local Development Framework policies:

## Camden Core Strategy

- CS5 - Managing the impact of growth and development
- CS15 - Protecting and improving our parks and open spaces & encouraging biodiversity
- CS16 - Improving Camden’s health and well-being

**Camden Development Policies**

- DP26 - Managing the impact of development on occupiers and neighbours
- DP28 - Noise and vibration
- DP31 - Provision of, and improvements to, public open space and outdoor sport and recreation facilities
- DP32 - Air quality and Camden's Clear Zones



## 2 Air quality

### KEY MESSAGES:

- All of Camden is a designated Air Quality Management Area due to the high concentrations of nitrogen dioxide (NO<sub>2</sub>) and particulate matter (PM<sub>10</sub>).
- All developments are to limit their impact on local air quality.

2.1 Poor air quality can harm health and the environment. The Council aims to make sure that new development does not harm air quality. This guidance provides advice on how to address air quality issues in planning applications.

2.2 Camden Core Strategy policy CS16 - *Improving Camden's health and well-being* and policy DP32 – *Air quality and Camden's Clear Zone* of the Camden Development Policies sets out our approach to air quality in the borough.

2.3 *Planning Policy Statement PPS23: Planning and Pollution Control* contains the Government's core policies and principles on air quality and air pollution. The London Plan outlines regional policies related to protecting local air quality during the planning process.



### Air quality in Camden

2.4 An Air Quality Management Area (AQMA) must be declared by the local authority for an area that is unlikely to meet the national air quality targets for specific air pollutants. The authority then produces a Local Air Quality Action Plan. See Camden's website for our air quality plan.

2.5 The whole of Camden is an Air Quality Management Area (AQMA) as it does not meet national air quality targets for nitrogen dioxide (NO<sub>2</sub>) and particulate matter (PM<sub>10</sub>). The main sources of air pollution in Camden are road transport and gas boilers. The Council's Air Quality Action Plan outlines measures to reduce emissions from the key sources of air pollution in the borough. Included in the plan are measures to minimise and control NO<sub>x</sub> and PM<sub>10</sub> emissions associated with new developments both during the construction of a building and its future use.

2.6 Air quality is particularly poor in the south of borough which is characterised by high levels of traffic. We will only grant planning permission for development that significantly increases travel demand in

the south of the borough where it includes appropriate measures to minimise the transport impact of development.

- 2.7 Where appropriate we will seek developments to include monitoring equipment to allow us to better understand local air quality.

#### **WHAT DOES THE COUNCIL REQUIRE?**

The Council's overarching aim is for new development is to be 'air quality neutral' and not lead to further deterioration of existing poor air quality.

You will be required to include mitigation and offsetting measures to deal with any negative air quality impacts associated with your development proposals. At the same time your development should be designed to minimise exposure of occupants to existing poor air quality.

To manage and prevent further deterioration of air quality in Camden, we will require an air quality assessment with planning applications for development that could have a significant negative impact in air quality. This impact can arise during both the construction and operational stages of a development as a result of increased NO<sub>x</sub> and PM<sub>10</sub> emissions.

- 2.8 An air quality assessment will also be required for a proposal if it introduces uses that are susceptible to poor air quality, such as housing or a school, into areas of particularly poor air quality.
- 2.9 The Council will not grant planning permission for developments that could significantly harm air quality or introduce people into areas of elevated pollution concentrations, unless mitigation measures are adopted to reduce the impact to acceptable levels and protect public exposure (see paragraph 32.4 of policy DP32 of the Camden Development Policies).
- 2.10 Although all of Camden is covered by an AQMA we will only require an air quality assessments where development could potentially cause significant harm to air quality as set out in the table below.

**An Air Quality Assessment is required in developments:**

- with potential to significantly change road traffic on any road exceeding 10,000 vehicles per day. Significant changes include:
  - increase in traffic volumes > 5% (Annual Average Daily Traffic (AADT) – or peak);
  - lower average vehicle speed or significant increase in congestion;
  - significant increase in the percentage of HGVs;
- that introduce, or increase car parking facilities by, 100 spaces or more;
- with commercial floorspace of more than 1,000sq m;
- with more than 75 homes;
- where people will be exposed to poor air quality for significant periods of the day, in particular developments located on busy roads;
- involving the following - biomass boilers, biomass or gas combined heat and power (CHP);
- involving industrial or commercial floorspace regulation under the Environmental Permitting (England and Wales) Regulations (EPR) which will be subject to Environmental Assessment under the Town and Country Planning (Environmental Impact Assessment) Regulations 1999.

**What should an air quality assessment cover?**

- 2.11 Air quality assessments for developments potentially contributing to poor air quality are to include the following:
- a) An inventory of the PM<sub>10</sub> and NO<sub>x</sub> emissions associated with the proposed development, including the type and quantity of emission concentrations, during the construction and operational phase. This shall cover transport, stationary and mobile emission sources.
  - b) The application of atmospheric dispersion modelling to predicted existing and future NO<sub>2</sub> and PM<sub>10</sub> concentrations, both with and without the proposed development. Dispersion modelling shall be carried out in accordance with Air Quality and Planning Guidance, London Councils (2007) and Technical Guidance Note (TG09). (Specific guidance for modelling combustion plant emissions can be obtained from the Council's Sustainability Team – see Useful Contacts at the end of this section).
  - c) An assessment of the significance of air quality impacts during both the construction and operational phases. Reference shall be made to the Environmental Protection UK Guidance Note: Development Control: Planning for Air Quality (2010 Update).
  - d) Consideration of the potential cumulative impacts on air quality which may arise during the construction or operational phases as a result of emissions arising from other developments within a 100m radius of the development.
  - e) Where a biomass boiler or combined heat and power (CHP)/combined cooling, heating and power (CCHP) will be used for

on site energy generation, you are to complete the Council's Air Quality Information Request Form. This requires specific technical details related to the appliance, fuel type, emission concentrations, maintenance and exhaust stack. The forms can be obtained from Camden's Air Quality Officer or the Council's air quality webpage under Environment.

- f) Applications which include biomass boilers or biomass CHP, the air quality assessment shall compare the impact of emissions from the intended biomass boiler/CHP and a gas boiler/CHP of identical thermal rating.
- g) An indication of the number of new occupiers and users of the site who will be exposed to poor air quality as a result of the development (the occupiers/users should also be shown on a map). For further information please refer to the Environmental Protection UK Guidance Note: Development Control: Planning For Air Quality (2010 Update).
- h) An assessment of the impacts on air quality of the demolition and construction phase and details of mitigation methods for controlling dust and emissions from plant and machinery. Reference should be made to the Best Practice Guidance: The control of dust and emissions at construction and demolition, London Councils (2006).
- i) An outline of, and justification for, mitigation measures associated with the design, location and operation of the development in order to reduce air pollution and exposure to poor air quality.

#### **Developments containing sensitive uses**

- 2.12 Developments which will not result in additional NO<sub>x</sub> and/or PM<sub>10</sub> emissions and present no risk in worsening air quality, but introduce new sensitive uses to an area which breaches the air quality standards for NO<sub>2</sub> or PM<sub>10</sub> need to submit an assessment of the local air quality but can omit requirements B, D and E above.

#### **What measures can reduce air pollution emissions and protect public exposure?**

- 2.13 Various actions can be taken to mitigate air pollution emissions arising from the construction and operational phases of a new development. Additional actions can be adopted to curtail public exposure in areas where air pollution levels are particularly high. These should be taken into account during the design stage of an application. The key measures are detailed below:

#### **Demolition and construction**

- 2.14 The impact of the construction and demolition phases of a development on air quality must be taken into account as part of your planning application. Exhaust



emissions from construction vehicles and machinery such as generators, piling and grinding equipment can result in:

- dust emissions;
- gases (NO<sub>x</sub>); and
- fine particles.

2.15 Controlling dust emissions is important to:

- prevent disturbance to local residents due to soiling;
- minimise damage to vegetation; and
- reduce impacts on local PM<sub>10</sub> concentrations, thereby protecting public health.

2.16 We may require PM<sub>10</sub> monitoring, before and during the construction and demolition phase, dependant upon the scale of the proposed development.

2.17 We will encourage best practice measures to be adopted during construction and demolition work to reduce and mitigate air pollution emissions. You will be encouraged to adopt the procedures outlined in the London Council's best practice guidance *The control of dust and emissions from construction and demolition*. These focus around three principles to control emissions – prevention, suppression and containment. We will expect you to include the following items in construction management plans:

- Identification of whether demolition/construction represents a low, medium or high risk site in the context of air quality.
- Identification of the best practice measure required to control and mitigate plant and vehicles exhaust emissions.  
(See section 8 of this Guidance on Construction management plans for further details).

#### **Distance of impacts**

Depending of the size, location and characteristics of your development, impacts from demolition and construction phases can occur at distance of 10 to 500m.

#### **Building location and design**

2.18 The location of a development has a direct influence on exposure to elevated air pollution levels. This is particular relevant where developments include sensitive uses such as hospitals, schools and children's playgrounds. Suitable building design, layout and orientation can avoid increasing exposure whilst minimising energy demand and energy loss. The Council requires the impact of outdoor air pollution on indoor air quality in new developments to be taken into account at the earliest stages of building design.

- 2.19 The location of outside space is also an important consideration and any exposure of gardens and roof terraces should be screened and, where practicable, minimised through appropriate positioning and orientation. You should take care not to locate flues and exhaust vents in close proximity to recreational areas such as roof terraces or gardens. An energy efficient building design can minimise air pollution resulting from the use of gas boilers. Adopting sustainable building design (e.g. the Code for Sustainable Homes and the Building Research Establishment Environmental Assessment Method (BREEAM)), will reduce thermal heat losses and result in less gas use leading to lower NO<sub>x</sub> emissions. See Camden Planning Guidance 3 – Sustainability for further details on the Code and BREEAM.

### Gas boilers

- 2.20 Gas boilers are a large source of NO<sub>x</sub> emissions in Camden. In order to minimise NO<sub>x</sub> emissions arising from heating and hot water systems the Council requires boilers fitted in new development to achieve a NO<sub>x</sub> emissions of <40 mg/m<sup>3</sup> and an energy efficiency rating >90%.

### Renewable Energy and Combined Heat and Power

- 2.21 Core Strategy policy CS13 promotes the use of renewable energy technologies to reduce carbon emissions and tackle climate change. The adoption of renewable energy and energy efficiency technologies in major developments can minimise air pollution emissions through reductions in gas consumption required for heating and hot water. These include solar thermal collectors and ground source heat pumps in addition to gas and hydrogen fuel cell combined heat and power (CHP) or combined cooling heat and power (CCHP).

#### Hydrogen fuel cell

A fuel cell is an electrochemical cell that converts energy from a fuel (hydrogen) into electricity.

- 2.22 Biomass boilers however can give rise to higher emissions of NO<sub>x</sub> and PM<sub>10</sub> emissions than conventional gas boilers. Permission to operate these appliances will only be granted if the air quality impacts are demonstrated to be equivalent or lower than those associated with a conventional gas boiler of similar thermal rating. Where an assessment demonstrates adverse effects on air quality, this type of biomass boiler should not be used in the development.
- 2.23 You are advised to refer to the national guidance note *Biomass and Air Quality Guidance Note for Local Authorities*, published by Environmental Protection UK. In cases where emissions released from a biomass boiler do not lead to negative impacts on air quality, the





appliance will be required to meet high standards of air pollution control with particular emphasis given to:

- boiler design and operation;
- pollution abatement equipment;
- servicing and maintenance;
- fuel quality, storage and delivery; and
- exhaust stack height.

2.24 We will require evidence that the exhaust stack height of gas CHP/CCHP has been appropriately calculated to guarantee that NO<sub>x</sub> emissions are effectively dispersed, and do not risk increasing ground level NO<sub>2</sub> concentrations. An air quality assessment will be required for developments including CHP/CCHP. Where the assessment reveals a negative impact on air quality, mitigation measures will be required entailing the best available techniques to reduce emissions. This includes the installation of NO<sub>x</sub> abatement technology such as:

- use of low NO<sub>x</sub> burners; or
- increasing stack height.

2.25 A programme of on-going maintenance and servicing will be necessary to minimise gas emissions released from CHP/CCHP.

2.26 The Council will use Section 106 obligations to set requirements for controlling emissions from biomass boilers and CHP/CCHP.

### **Traffic Reduction**

2.27 Reducing car usage caused by new developments is the principle way to minimise vehicle emissions and protect local air quality. Please refer to transport policy *CS11 - Promoting sustainable and efficient travel* in the Camden Core Strategy for more on our approach to improving air quality through transport measures. This requires:

- the adoption of car free and car capped developments;
- provision cycling facilities to encourage sustainable transport;
- green travel plans;
- provision of car club bays; and
- infrastructure for low emissions vehicles such as electric vehicle recharging points.



### Further information

Planning Guidance	<ul style="list-style-type: none"> <li>• Planning Policy Statement 23: Planning and Pollution Control (2004)</li> <li>• Planning Policy Statement 23 Annex 1: Pollution Control, Air and Water Quality These documents outline the government's advice on methods of planning for pollution control.</li> </ul>
Air Quality Guidance	<ul style="list-style-type: none"> <li>• Technical Guidance Note: Assessment of Air Quality Issues of Planning Applications, Association of London Government (ALG), 2006 This provides technical advice on how to deal with planning applications that could have an impact on air quality.</li> <li>• Development Control: Planning for Air Quality. Environmental Protection UK, 2010 This advises of the significance of air quality assessments within the planning process.</li> <li>• Best Practice Guidance - The control of dust and emissions from construction and demolition (London Councils) 2006 The aim of this guidance is to protect the health of on-site workers and the public and to provide London-wide consistency for developers.</li> <li>• Biomass and Air Quality Guidance for Local Authorities (Environmental Protection UK) 2009 This guidance details procedures for assessing and managing the effects of biomass on air quality and provides background material.</li> <li>• Low Emission Strategies (Beacon Low Emission Group) 2009 This provides advice on how to reduce emissions of air pollutants and greenhouse gases from transport.</li> </ul>
Useful Contacts	<p>Camden Council Corporate Sustainability Team  <a href="http://www.camden.gov.uk/smallsteps">www.camden.gov.uk/smallsteps</a> (020 7974 4444)          provides guidance on air quality in Camden</p>

## 3 Contaminated land

### KEY MESSAGES:

- Contaminated land can pose a serious risk to health.
- The Council will expect developers to identify and assess potentially contaminated land at an early stage.
- Developers will be expected to follow the Council's Contaminated Land Strategy.

3.1 This guidance provides advice on how to approach the development of potentially contaminated sites. This guidance should be read in conjunction with Core Strategy policy CS16 – *Improving Camden's health and well-being*.

3.2 To protect the local environment and the health and well-being of residents, workers and visitors, we will carefully assess any proposals for the redevelopment of sites that:

- are known to be contaminated;
- have the potential to be contaminated, through previous or current uses; or
- are located in close proximity to these sites.

### What is contaminated land?

3.3 Contaminated land is land that has been polluted with harmful substances to the point where it now poses a serious risk to health and the environment.

### Causes of land contamination

- improper chemical handling or disposal practices,
- accidental spillages, or leakages of chemicals during manufacturing or storage.
- polluted groundwater migrating under a site
- particles settling from factory emissions.

3.4 The most common pollutants of land are metals and organic compounds. Typical land uses that can cause land contamination include petrol stations and gas works.

3.5 Contamination can also come from historical activities dating back many hundreds of years, such as spoil heaps from some Roman lead mines, and even from naturally occurring substances.

3.6 Contaminants may still be present above acceptable levels even though the polluting use stopped many years ago. 'Contaminated land' has a specific legal definition which is used in relation to an 'unacceptable risk'

of harm to health. For more information please see Department for Environment, Food and Rural Affairs (DEFRA) web pages.

- 3.7 In principle we will support the redevelopment of contaminated sites where the contamination issue can be successfully addressed and where future uses can be carried out safely. Remediation is particularly important where people have access to ground for gardening, play or planting food for consumption within redeveloped sites.

### **What should you do if your site is contaminated or potentially contaminated?**

- 3.8 In accordance with Planning Policy Statement (PPS) 23: Planning and Pollution Control, if you propose a development on contaminated or potentially contaminated land, it is your responsibility to ensure that contaminated land issues are considered at the planning application stage.
- 3.9 Where contamination is known or suspected on a site or the proposed use would be vulnerable to contamination, we will expect you to provide, as a part of your planning application, the necessary information as outlined in this chapter to determine whether the proposed development is acceptable.
- 3.10 The information required will need to be sufficient for us to determine:
- the existence or otherwise of contamination;
  - the nature of the contamination and the risks it may pose; and
  - whether these can be satisfactorily reduced to an acceptable level.
- Please refer to Annex 2 of PPS23 for further details.
- 3.11 The identification and assessment of land contamination issues is to be carried out by a qualified and experienced consultant, in consultation with the Council's Environmental Health Service. The contamination report is to be submitted with your planning application so that contamination issues can be assessed at the planning application stage and any necessary remediation measures secured through conditions or a Section 106 legal agreement.
- 3.12 The Council's Contaminated Land Strategy sets out how we will:
- deal with contaminated land;
  - make information available to the public; and
  - implement the requirements of the Part IIa of the Environmental Protection Act 1990 and Environment Act 1995. This and other documents are available on the Council's website ([www.camden.gov.uk/contaminatedland](http://www.camden.gov.uk/contaminatedland)) and should be referred to where contamination is a potential issue.
- 3.13 If there is any existing contamination (or potential risk of contamination) to ground or surface water or to land with statutory nature conservation designation, either from the existing state of land or from proposed

works, the Environment Agency must be informed and their consent obtained to any works. The English Heritage Archaeological Section should be contacted where contaminated land is included within an Archaeological Priority Area.

**Archaeological Priority Area**

As specified in the Camden Proposals Map, and Map 4 of the Camden Development Policies, to help protect archaeological remains that might be affected by development. See policy DP25 Conserving Camden's Heritage of the Camden Development Policies for further guidance on the borough's Archaeological Priority Areas.

- 3.14 Your report should comply with the policies and advice given in PPS23 and its annexes. There are also various best practice documents and British Standards that should be followed. The London Boroughs have produced a local guidance document titled *Contaminated Land: A Guide to Help Developers Meet Planning Requirements*. This document provides guidance on what information should be contained within a contamination report and is available on Camden's website.

### Supporting documents

PPS23	<p>Planning Policy Statement 23: Planning and Pollution Control. Office of the Deputy Prime Minister, November 2004. <a href="http://www.odpm.gov.uk">www.odpm.gov.uk</a></p> <p>In particular Annex 2 should be referred to as this section deals specifically with contaminated land issues. The policies and advice contained in PPS23 is not repeated in this guidance and therefore should be consulted for detailed guidance.</p>
Camden Council Website	<p>Information on the Council approach to management of land contamination, information on historical land uses in the Borough and a copy of the London Borough's 'Guide for Developers on Contaminated Land'.</p> <p><a href="http://www.camden.gov.uk/contaminatedland">http://www.camden.gov.uk/contaminatedland</a></p>
Department of Food, Environment and Rural Affairs	<p>has published a number of documents on land contamination. These can be found at:</p> <p><a href="http://www.defra.gov.uk/environment/land/contaminated/index.htm">www.defra.gov.uk/environment/land/contaminated/index.htm</a></p>
Environment Act 1995	<p>Available from Stationary Office:</p> <p><a href="http://www.opsi.gov.uk/acts/acts1995/Ukpga_19950025_en_1.htm">www.opsi.gov.uk/acts/acts1995/Ukpga_19950025_en_1.htm</a></p>

### Useful Contacts

Camden Environmental Health Service (Contaminated Land) web page [www.camden.gov.uk/contaminatedland](http://www.camden.gov.uk/contaminatedland) has more information on the Council's approach to contaminated land.

English Heritage [www.english-heritage.org.uk](http://www.english-heritage.org.uk) can provide advice on the approach to contaminated land within Archaeological Priority Areas.

## 4 Noise and vibration

### KEY MESSAGES:

We will ensure that noise and vibration is controlled and managed to:

- Limit the impact of existing noise and vibration sources on new development; and
- Limit noise and vibration emissions from new development.

- 4.1 The impact of noise and vibration can have a major affect on amenity and health and can severely affect people's quality of life.
- 4.2 Policy *DP28 – Noise and Vibration* of the Camden Development Policies aims to ensure that noise and vibration is controlled and managed. It sets out the Council's thresholds for noise and vibration and goes beyond the thresholds set out in Planning Policy Guidance 24: Planning and noise (see below). DP28 contains noise/vibration thresholds for the day, evening and night.



## **How can the impact of noise and vibration be minimised?**

4.3 The main sources of noise and vibration in Camden are generated from:

- Road traffic;
- Railways;
- Industrial uses;
- Plant and mechanical equipment;
- Entertainment uses (such as bars and nightclubs); and
- Building sites.

4.4 For details on how to manage noise and vibration from building sites see section 8 on Construction management plans.

## **Ways to minimise the impact of noise on your development**

### **Design**

- Locating noise sensitive areas/rooms away from the parts of the site most exposed to noises;
- Creating set backs;
- Designing the building so its shape and orientation reflect noise and protect the most sensitive uses;
- Stacking similar rooms (such as kitchens and living rooms) above each other; and
- Positioning non-residential uses closer to the noise source in mixed use developments.

### **Built fabric**

- Insulating and soundproofing doors, walls, windows, floors and ceilings;
- Sealing air gaps around windows;
- Double glazing;
- Including architectural fins (where appropriate); and
- Laminated glass.

### **Landscaping and amenity areas**

- Incorporating planting, landscaping, fencing/barriers and solid balconies to reflect sound.

4.5 Our preference for controlling noise:

- Begins with attempting to reduce noise at its source;
- Then to separate the development (or at least the sensitive parts e.g. habitable rooms) from the source or to use noise barriers; and



- Finally construction materials such as acoustic glazing should be used.

- 4.6 When you consider measures to minimise noise and vibration you also need to take into account our policies on design and crime prevention. You should consider the implications of noise and vibration at the beginning of the design process to enable prevention or mitigation measures to be designed into the scheme. Poorly designed schemes will not be acceptable.
- 4.7 Proposals will be expected to include appropriate attenuation to alleviate or mitigate the impact of noise and vibrations to an acceptable level, as set out in policy *DP28 – Noise and vibration* of the Camden Development Policies. Where appropriate, the Council will consider the cumulative impact of noise sources (for example, air conditioning units).
- 4.8 Everyday domestic activities can also generate noise, e.g. communal entrances and roof terraces. Sufficient sound insulation must be provided between dwellings to prevent the transmission of noise between them, particularly in conversions where new partition walls are often deficient in terms of insulation.

### **Ways to mitigate noise emitted by your development**

#### **Engineering**

- Reducing the noise emitted at its point of generation (e.g. by using quiet machines and/or quiet methods of working);
- Containing the noise generating equipment (e.g. by insulating buildings which house machinery and/or providing purpose-built barriers around the site); and
- Protecting any surrounding noise-sensitive buildings (e.g. by improving sound insulation in these buildings and/or screening them by purpose-built barriers).

#### **Layout**

- Ensuring an adequate distance between source and noise-sensitive buildings or areas; and
- Screening by natural barriers, buildings, or non-critical rooms in the development.

#### **Administrative**

- Limiting the operating time of the source;
- Restricting activities allowed on the site; and
- Specifying an acceptable noise limit.

- 4.9 If your proposal could result in noise and vibration that would cause an unacceptable impact to nearby uses or occupiers, or proposes sensitive uses near a source of noise or vibration and cannot be adequately attenuated then planning permission is likely to be refused.

Developments will be assessed against the thresholds set out in policy DP28.

### **How will the Council manage the impact of noise and vibration?**

- 4.10 Detailed acoustic/noise and vibration information in the form of a report will be required if your development proposes:
- The installation of plant, ventilation or air conditioning equipment;
  - A use that will create significant noise (e.g. new industry, nightclub)
  - A noise-sensitive development in an area where existing noise sources are present (e.g. an existing industrial site, busy road, railway line);
  - A use that will generate a significant amount of traffic.

#### **Noise sensitive developments**

Those developments located near sources of noise, including housing, schools and hospitals as well as offices, workshops and open spaces.

- 4.11 The list above is a guide only and you may need to provide noise and vibration information for other developments depending on the circumstances of the site or proposal.
- 4.12 The appropriate amount and detail of information required will depend on the specific circumstances of your proposal. At a minimum you will be expected to provide the following information to support your application:
- Description of the proposal;
  - Description of the site and surroundings, a site map showing noise and vibration sources, measurement locations and noise receivers;
  - Background noise levels;
  - Details of instruments and methodology used for noise measurements (including reasons for settings and descriptors used, calibration details);
  - Details of the plant or other source of noise and vibration both on plan and elevations and manufacturers specifications;
  - Noise or vibration output from proposed plant or other source of noise and vibration, including:
    - Noise or vibration levels;
    - Frequency of the output;
    - Length of time of the output;
    - Features of the noise or vibration e.g. impulses, distinguishable continuous tone, irregular bursts;
  - Manufacturers' specification of the plant, supporting structure, fixtures and finishes;

- Location of neighbouring windows (and use if applicable);
- Details of measures to mitigate noise or fume emissions and vibration;
- Details of any associated work including acoustic enclosures and/or screening;
- Cumulative noise levels of all the proposed and existing units;
- Hours/days of operation.

4.13 Where appropriate the Council will seek a legal agreement to control or reduce noise levels where this is unlikely to be met through the use of a condition attached to a planning permission.

### Further information

PPG24	<p>Planning Policy Guidance Note 24: Planning and Noise provide Government guidance on noise. This guidance defines four Noise Exposure Categories (A-D) and outlines what should be done if your proposal falls into one of these categories. Advice is also provided on how to address noise issues and secure amelioration methods through the planning system.</p> <p><a href="http://www.communities.gov.uk/publications/planningandbuilding/ppg24">www.communities.gov.uk/publications/planningandbuilding/ppg24</a></p>
DEFRA	<p>The Department of Food, Environment and Rural Affairs provide a number of publications on noise and noise related issues.</p> <p><a href="http://www.defra.gov.uk">www.defra.gov.uk</a></p>
Camden Council website	<p>Camden's Environmental Health web pages provide strategic information on noise in Camden including the results of monitoring that has taken place</p> <p><a href="http://www.camden.gov.uk/noise">www.camden.gov.uk/noise</a></p> <p>Also see <i>Camden's Guide for Contractors working in Camden</i> on the Camden website.</p>
The Mayor's Ambient Noise Strategy	<p>This provides details on the Mayor of London's approach to reducing noise in London.</p> <p><a href="http://legacy.london.gov.uk/mayor/strategies/noise/docs/noise_strategy_all.pdf">http://legacy.london.gov.uk/mayor/strategies/noise/docs/noise_strategy_all.pdf</a></p>



## 5 Artificial light

### KEY MESSAGES:

When considering proposals for artificial lighting the Council will consider the:

- need for planning permission;
- need for the lighting;
- design of the lighting; and
- impacts on biodiversity.

5.1 This section provides guidance on the Council's approach to artificial lighting. This guidance should be read in conjunction with policy *DP26 Managing the impact of development on occupiers and neighbours* of the Camden Development Policies.

5.2 Artificial lighting has many benefits, however excessive or poorly designed lighting can be damaging to the environment and result in visual nuisance including by:

- Having a detrimental impact on the quality of life of neighbouring residents;
- Significantly changing the character of the locality;
- Altering wildlife and ecological patterns; and
- Wasting energy.



5.3 Nuisance often occurs due to glare and 'light spillage' because the lighting has been poorly designed.

5.4 *Planning Policy Statement 23 (PPS23): Planning and Pollution Control* enables the Council to take account of the possible obtrusive impact of

lighting and paragraph 3.25 of PPS23 permits us to use conditions or planning obligations to protect the environment.

#### **WHAT IS LIGHT POLLUTION?**

Light pollution is the term used to describe any adverse effect of artificial lighting. Light pollution includes:

- Glare - the uncomfortable brightness of a light source when viewed against a dark sky;
- 'Light trespass' – the spread of light spillage the boundary of the property on which a light is located; and
- 'Sky glow' - the orange glow we see around urban areas caused by a scattering of artificial light by dust particles and water droplets in the sky.

### **Will planning permission be required for lighting?**

- 5.5 Structures supporting, and the installation of lighting equipment may require planning permission, especially if they are substantial or affect the external appearance of a building. Planning permission is not required for the carrying out of maintenance which affects only the interior of the building or does not materially affect the external appearance of the building. Temporary lighting schemes generally do not require planning permission.
- 5.6 Planning permission is normally required for:
- the erection of columns to support lighting or other similar structures;
  - the erection of substantial structures or installations that affect the external appearance of a property;
  - external lighting as part of an industrial or commercial scheme;
  - new lighting structures or works which are integral to other development requiring planning permission; and
  - illuminated advertisements, although there are some exceptions such as those indicating medical services and some commercial advertisements on the front of business premises (See Camden Planning Guidance 1 - Design).
- 5.7 You are advised to check with the Planning Service before installing any lighting scheme. You will need to provide the following details:
- Number of lights;
  - Likely lux output;
  - The height of the lighting columns (if applicable); and
  - The area to be lit.
- In accordance with policy DP26 in Camden Development Policies, schemes that would cause harm to amenity will not be permitted.

### **What information should accompany a planning application?**

- 5.8 Where planning permission for lighting schemes is required you will need to submit the information required by paragraph 5.7. We will also expect the submission of the following additional information:
- The design of lights and infrastructure;
  - A plan or plans showing layout of the lights, including orientation of the beams of light;
  - Lighting levels, lumen details, lamp type, wattage;
  - Control systems including types and location of sensors, times lighting will be on; and
  - The need for the lighting, that is, an explanation of what activity the lighting is supporting.



- 5.9 All light installations must be energy efficient and 'Dark Sky' compliant, thereby not causing obtrusive light pollution, glare or spillage (by reference to the British Astronomical Association Campaign for Dark Skies).

**Lumen**

This is a measurement of the light output from a light source.

**Lux**

This is a measurement of the light intensity falling on a surface.

**Dark sky compliance**

To design lighting schemes in order to avoid lighting that extends beyond its intended target and would be inefficient and waste energy. It also avoids glare and light in unwanted areas.

## What should you consider when designing lighting?

### General lighting requirements

- 5.10 To minimise obtrusive light you should follow the general principles taken from the Institution of Lighting Engineers, Guidance Notes for the Reduction of Obtrusive Light (2005):
- a) Lighting is to be directed downwards wherever possible to illuminate its target. If there is no alternative to up lighting, then the use of shields will help reduce the spill of light to a minimum. Up lighting is a particularly bad form of obtrusive light and contributes to sky glow.
  - b) Lighting is to be designed to minimise the spread of light near to, or above, the horizontal. Again, any light that shines above the horizontal line of the light adds to the sky glow effect.
  - c) Lighting should be designed to the correct standard for the task. Over-lighting is a cause of obtrusive light and also represents a waste of money and energy.
  - d) The main beam angle of all lights proposed directed towards any potential observer is to be kept below 70°. It should be noted that the higher the mounting height, the lower the main beam angle could be. This will help reduce the effect of glare and light spill on neighbouring dwellings, passing motorists, pedestrians, etc.
  - e) Lighting should be directed to minimise and preferably avoid light spillage onto neighbouring properties. Wherever possible use floodlights with asymmetric beams that permit the front glazing to be kept at, or near parallel to, the surface being lit.
  - f) The lights used should be the most efficient taking into account cost, energy use, and the purpose of the lighting scheme required. All lighting schemes should meet British Standards.
- 5.11 We will seek to ensure that artificial lighting is sited in the most appropriate locations to cause minimal disturbance to occupiers and wildlife, while still illuminating the intended area. This includes considering any occupiers located above the lighting source.

- 5.12 Consideration should be given to lighting associated with buildings of special historic and architectural interest in order to protect their special interest and that of the wider area. This applies both to the lighting of such buildings and the impact of the lighting installation when seen by day.

### **Lighting Infrastructure**

- 5.13 The visual effect of lighting infrastructure when viewed in the daytime needs to be considered. These elements can include junction boxes, poles, brackets and cabling. The design, size and colours of the physical infrastructure needs to be carefully considered and should relate to the building it is located on.

### **Use**

- 5.14 The design of lighting should be specific to the use it supports (e.g. for recreation facilities). Hours of lighting should be limited to the times needed to support the use (both in summer and winter) and be restricted through the use of timers and sensors where relevant (e.g. for security lighting).
- 5.15 The Council may seek to secure conditions to any planning permission in order to control the hours of operation of any approved lighting scheme.

### **Why do impacts on biodiversity need to be considered?**

- 5.16 Artificial lighting can often impact on wildlife habitats, particularly where lighting is proposed in open spaces, for example to provide lighting for sports courts and pitches or to improve security (such as along Regents Canal). Artificial lighting can have particularly severe implications for the natural daily rhythms of a range of animals and plants, and therefore sites and habitats identified for their nature conservation value should not be adversely affected by lighting. (See the Local Development Framework Proposals Map for a list of nature conservation sites).
- 5.17 If your proposed lighting is located within or adjacent to areas of open space we will expect that any biodiversity impacts arising from the installation or operation of the lighting is mitigated. This may require a survey to identify if there are any nesting birds in the immediate vicinity or if it is close to an area where bats may hibernate or emerge at feeding time. This is particularly important if the operation of the lighting extends beyond dusk, which is roughly the time bats will come out to forage. See Camden Planning Guidance 3 – Sustainability for further information on our approach to protecting biodiversity.
- 5.18 You should contact Camden's Biodiversity Officer at an early stage to discuss measures to mitigate the impact of lighting schemes on biodiversity.

### Further information

PPS23	Planning Policy Statement 23: Planning and Pollution Control. Office of the Deputy Prime Minister, November 2004. <a href="http://www.odpm.gov.uk">www.odpm.gov.uk</a>
DEFRA	The Department of Food, Environment and Rural Affairs has published a number of documents on light pollution. These can be found at: <a href="http://www.defra.gov.uk/environment">http://www.defra.gov.uk/environment</a>
Environment Act 1995	Available at the Stationary Office: <a href="http://www.opsi.gov.uk/acts/acts1995/Ukpga_19950025_en_1.htm">www.opsi.gov.uk/acts/acts1995/Ukpga_19950025_en_1.htm</a>

### Useful Contacts

Camden Planning Service [www.camden.gov.uk/planning](http://www.camden.gov.uk/planning)

The Institution of Lighting Professionals [www.theilp.org.uk](http://www.theilp.org.uk) promotes good practice and excellence in lighting schemes.

The Chartered Institute of Building Services Engineers [www.cibse.org](http://www.cibse.org) provides information on appropriate lighting designs and mechanisms.

## 6 Daylight and sunlight

### KEY MESSAGES:

- We expect all buildings to receive adequate daylight and sunlight.
- Daylight and sunlight reports will be required where there is potential to reduce existing levels of daylight and sunlight.
- We will base our considerations on the Average Daylight Factor and Vertical Sky Component.

6.1 Access to daylight and sunlight is important for general amenity, health and well-being, for bringing warmth into a property and to save energy from reducing the need for artificial lighting and heating. The Council will carefully assess proposals that have the potential to reduce daylight and sunlight levels for existing and future occupiers.

6.2 This guidance relates to:

- Camden Core Strategy policy CS5 - *Managing the Impact of Growth and Development*;
- Core Strategy policy CS14 - *Promoting high quality places and conserving our heritage*; and
- Policy DP26 – *Managing the impact of development on occupiers and neighbours* of the Camden Development Policies.

DP26 sets out how the Council will protect the quality of life of building occupiers and neighbours by only granting permission for development that does not cause harm to amenity.

### **When will a daylight/sunlight report be required?**

6.3 The Council expects that all developments receive adequate daylight and sunlight to support the activities taking place in that building.

6.4 A daylight and sunlight report should assess the impact of the development following the methodology set out in the most recent version of Building Research Establishment's (BRE) "Site layout planning for daylight and sunlight: A guide to good practice". Reports may be required for both minor and major applications depending on whether a proposal has the potential to reduce daylight and sunlight levels. The impact will be affected by the location of the proposed development and its proximity to, and position in relation to, nearby windows.

### WHAT DOES THE COUNCIL REQUIRE?

The Council will require a daylight and sunlight report to accompany planning applications for development that has the potential to reduce levels of daylight and sunlight on existing and future occupiers, near to and within the proposal site.

Daylight and sunlight reports should also demonstrate how you have taken into consideration the guidance contained in the BRE document on passive solar design; and have optimised solar gain. Please refer to the BRE guidance on daylight and sunlight.

- 6.5 While we strongly support the aims of the BRE methodology for assessing sunlight and daylight we will view the results flexibly and where appropriate we may accept alternative targets to address any special circumstances of a site. For example, to enable new development to respect the existing layout and form in some historic areas. This flexible approach is at the Council's discretion and any exception from the targets will be assessed on a case by case basis.

#### Daylight

- 6.6 We will aim to minimise the impact of the loss of daylight caused by a development on the amenity of existing occupiers and ensure sufficient daylight to occupiers of new dwellings taking in account overall planning and site considerations. If your proposal will have an unreasonable impact on amenity the planning application will be refused. When assessing daylight issues, we will use the guidelines and methods contained in the BRE's *Site layout planning for daylight and sunlight: A guide to good practice*.
- 6.7 There are two quick methods that can be used to assess access to daylight:

#### Daylight to new development

- project a 25 degree line, starting 2m above ground level from a wall of your proposed development;
- if none of the existing surrounding buildings extend above this line, then there is potential for good daylighting to be achieved in the interior of your new development.

#### Daylight to existing development

- project a 25 degree line from the centre of the lowest window on the existing building;
- if the whole of your new development is lower than this line then it is unlikely to have a substantial effect on the daylight enjoyed by occupants in the existing building.

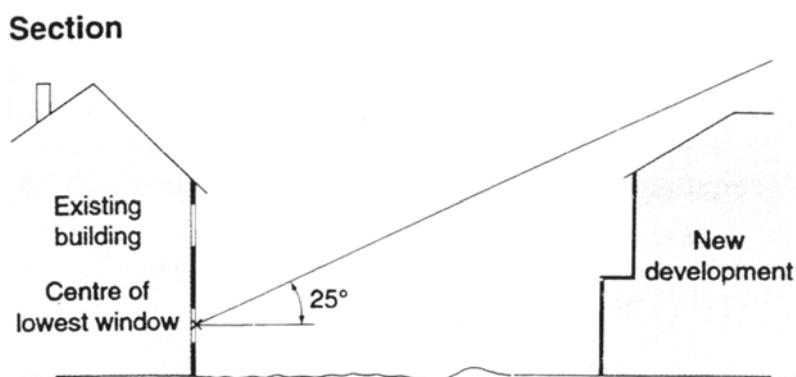

Source: BRE, Site layout planning for daylight and sunlight: A guide to good practice.

- 6.8 For either test, if buildings extend above the 25 degree line a more detailed test needs to be carried out to fully assess either the loss of daylight in existing buildings or the level of daylight achievable in the new development. The two most common measurements of daylight of the more detailed test are the Vertical Sky Component (VSC) and the Average Daylight Factor (ADF).

**Vertical Sky Component**

The amount of light striking the face of a window

- 6.9 The Vertical Sky Component is expressed as a ratio of the maximum value of daylight achievable for a completely unobstructed vertical wall. The maximum value is almost 40%. This is because daylight hitting a window can only come from one direction immediately halving the available light. The value is limited further by the angle of the sun. This is why if the VSC is greater than 27% enough sunlight should be reaching the existing window. Any reduction below this level should be kept to minimum.
- 6.10 Windows to some existing rooms may already fail to achieve this target under existing conditions. In these circumstances it is possible to accept a reduction to the existing level of daylight to no less than 80% of its former value. Any greater reduction than this is likely to have a noticeable affect on amenity. If this occurs then applications may be refused.

**Average Daylight Factor**

Average Daylight Factor is a measure of the level daylight in a room. It can be used to establish whether a room will have a predominantly daylight appearance. It provides light levels below which a room should not fall even if electric lighting is provided.

- 6.11 The Average Daylight Factor can be used as a measure to determine whether a room will receive adequate daylight (expressed as a percentage). The ADV takes into account the:
- net glazed area of windows;

- the total area of the room surfaces (ceiling, floor, walls, and windows);
  - the average reflectance; and
  - the angle of visible sky.
- 6.12 If a predominately daylit appearance is required, then the daylight factor should be 5% or more if there is no supplementary electric lighting, or 2% or more if supplementary electric lighting is provided. This figure should be as high as possible to enable occupiers to rely on as much natural light and not use artificial lighting, but as a minimum for dwellings the figures should be 2% for kitchens, 1.5% for living rooms and 1% for bedrooms.
- 6.13 These minimum figures may not be applicable when measuring the impact of new buildings on existing dwellings as the simple preservation of minimum ADFs will not necessarily be seen as an indication of acceptability, especially if the VSC demonstrates a significant worsening in daylight levels. For existing dwellings the Council will consider the overall loss of daylight as opposed to the minimum acceptable levels of daylight. As the BRE guidance suggests, the readings will be interpreted flexibly as their aim is to support rather than constrain natural lighting. However, daylight is only one of the many factors in site layout design. Therefore, when applying these standards in Camden, we will take into consideration other site factors and constraints.
- 6.14 The calculation of the VSC and the ADF is complex. For full details on how these calculations are carried out you should refer to the most up to date version the BRE's "Site layout planning for daylight and sunlight: A guide to good practice". For more complex and larger developments we will expect a daylight study to be submitted with the planning application showing the windows that will be affected and provide before development and post development figures for VSC and ADF.
- 6.15 Other methods can be used to measure daylight and these can be incorporated in daylight and sunlight reports, where necessary, as a supplement to VSC and ADF measurements, such as the No Sky Line (NSL) test contained within BRE guidance.

### **Sunlight**

- 6.16 The design of your development should aim to maximise the amount of sunlight into rooms without overheating the space and to minimise overshadowing.



**WHAT DOES THE COUNCIL EXPECT?**

New developments should be designed to provide at least one window to a habitable space facing within 90 degrees of south, where practical. This window should receive at least 25% of Annual Probable Sunlight Hours, including at least 5% of Annual Probable Sunlight Hours between 21 September and 21 March, where possible.

**Annual Probable Sunlight Hours**

The annual amount of sunlight a window receives in an average year.

- 6.17 The BRE's "Site layout planning for daylight and sunlight: A guide to good practice" provides guidance on access to sunlight in relation to:
- site layout, building orientation and overshadowing for new buildings;
  - protecting sunlight to existing buildings, and
  - new and existing gardens and open spaces.
- 6.18 Design for access to sunlight will be specific to the orientation of your site, and the specific design and uses within your proposed development. You should follow the detailed design requirements recommended in the "Sunlighting" section of the BRE document. The Council recognises that not all of the guidance contained within the BRE document, particularly orientation, can be adhered to in all developments due to the dense and constrained urban nature of Camden.

**Other considerations****Right to Light**

- 6.19 The right to light is a legal right which one property may acquire over the land of another. If a structure is erected which reduces the light to an unobstructed property to below sufficient levels this right is infringed. A right to light can come into existence if it has been enjoyed uninterrupted for 20 years or more, granted by deed, or registered under the Rights of Light Act 1959. Planning permission does not override a legal right to light, however where a right to light is claimed, this is a matter of property law, rather than planning law. The Council will have no role or interest in any private dispute arising and it will be for the owner or occupier affected to seek a legal remedy.

**Supporting documents**

- 6.20 For further information on daylight and sunlight please refer to:  
Building Research Establishment (BRE). Site layout planning for daylight and sunlight: A guide to good practice.  
Copies of this are available directly from BRE.

BRE Bookshop, 151 Roseberry Avenue, London, EC1R 4GB  
020 7505 6622  
brebookshop@emap.com  
[www.constructionplus.co.uk](http://www.constructionplus.co.uk)

## 7 Overlooking, privacy and outlook

### KEY MESSAGES:

- Development are to be designed to protect the privacy of existing dwellings;
- Mitigation measures are to be included when overlooking is unavoidable;
- Outlook from new developments should be designed to be pleasant;
- Public spaces benefit from overlooking as natural surveillance.

- 7.1 This section aims to ensure that when designing your development you successfully consider the potential impact on the privacy and outlook of neighbouring properties.
- 7.2 This guidance relates to Core Strategy policy CS5 Managing the Impact of Growth and Development and Core Strategy policy CS14 Promoting high quality places and conserving our heritage.
- 7.3 Policy *DP26 – Managing the impact of development on occupiers and neighbours* of the Camden Development Policies outlines how the Council will protect the quality of life of occupiers and neighbours by only granting permission for development that does not cause harm to amenity.

### Overlooking and privacy

- 7.4 Development should be designed to protect the privacy of both new and existing dwellings to a reasonable degree. Spaces that are overlooked lack privacy. Therefore, new buildings, extensions, roof terraces, balconies and the location of new windows should be carefully designed to avoid overlooking. The degree of overlooking depends on the distance and the horizontal and vertical angles of view. The most sensitive areas to overlooking are:
- Living rooms;
  - Bedrooms;
  - Kitchens; and
  - The part of a garden nearest to the house.

### WHAT IS GOOD PRACTICE?

To ensure privacy, there should normally be a minimum distance of 18m between the windows of habitable rooms of different units that directly face each other. This minimum requirement will be the distance between the two closest points on each building (including balconies).

- 7.5 Where this standard cannot be met we may require you to incorporate some of the following design measures into your scheme to ensure

overlooking is reduced to an acceptable level. Design measures to reduce the potential for overlooking and the loss of privacy include:

- Careful consideration of the location of your development, including the position of rooms;
- Careful consideration of the location, orientation and size of windows depending on the uses of the rooms;
- Use of obscure glazing;
- Screening by walls or fencing; and
- Screening by other structures or landscaping.

7.6 Where landscaping is used as a method of screening, arrangements for ongoing maintenance should be put in place and this may be secured by a planning condition.

7.7 Public spaces and communal areas will benefit from a degree of overlooking due to the increased level of surveillance it can provide.

### **Outlook**

7.8 Outlook is the visual amenity enjoyed by occupants when looking out of their windows or from their garden. How pleasant an outlook is depends on what is being viewed. For example, an outlook onto amenity space is more pleasant than an outlook across a servicing yard. You should design developments so that the occupiers have a pleasant outlook. You should screen any unpleasant features with permanent landscaping.

7.9 When designing your development you should also ensure the proximity, size or cumulative effect of any structures do not have an overbearing and/or dominating effect that is detrimental to the enjoyment of their properties by adjoining residential occupiers. You should carefully consider the location of bin or cycle stores if they are in close proximity to windows or spaces used by occupiers.

7.10 You should take particular care if your development adjoins properties with a single aspect over your development.

7.11 You should note that the specific view from a property is not protected as this is not a material planning consideration.

### **Further information**

*Better Places to Live: By Design - A companion guide to PPG3* (ODPM) makes number of design recommendations which recognise the importance of privacy in the home.

*Perceptions of Privacy and Density in Housing* report available from Design for Homes; 0870 416 3378 or [www.designforhomes.org](http://www.designforhomes.org). This report highlights some of the issues facing households living at higher densities, and the implications for future design of buildings.

## 8 Construction management plans

### KEY MESSAGES:

- Construction management plans are required for developments that are on constrained sites or are near vulnerable buildings or structures;
- They are essential to ensure developments do not damage nearby properties or the amenity of neighbours.

- 8.1 The purpose of this guidance is to give details on how construction management plans can be used to manage and mitigate the potential impacts of the construction phase of a development.
- 8.2 All construction and demolition work will cause at least some noise and disturbance. Where construction impact is particularly significant Camden will ensure it is managed through a legally binding construction management plan.
- 8.3 This guidance relates to Core Strategy Policy CS5 Managing the impact of growth and development and policies DP20 Movement of goods and materials, and DP26 Managing the impact of development on occupiers and neighbours of the Camden Development Policies.

### When does this guidance apply?

- 8.4 This guidance applies to all development proposals which, having regard to the nature of the surrounding area, are likely to give rise to significant noise and other disturbance during construction. Details on the circumstances in which the Council will expect construction management plans are set out within this guidance.

### How should construction management plans be prepared?

- 8.5 Camden's planning policies make it clear that the effect on local amenity and the highway network from construction and demolition is a material planning consideration. Construction management plans are used to set out the measures a developer should take (both on-site and off-site) in order to reasonably minimise and manage the detrimental effects of construction on local amenity and/or highway safety. Usually Camden will secure construction management plans through a Section 106 Agreement, although sometimes for less complicated schemes they may be secured by using a condition attached to planning permission.
- 8.6 Whilst construction management plans are a 'planning led' document they will incorporate mechanisms controlling planning considerations that overlap with other regulatory regimes (particularly highways and environmental protection). Hence, most construction management plans will be an umbrella document managing all impacts of the demolition, excavation and construction process.

- 8.7 Besides ensuring measures under these different regimes are coordinated in one document, construction management plans represent a proactive way of dealing with construction issues. They encourage developers to work with the Council and local people in managing the construction process with a view to ensuring that problems do not arise in the first place.

**Circumstances Camden will expect a construction management plan**

- 8.8 Whether a construction management plan is required for a particular scheme will be assessed on a case by case basis, although the Council will usually require a construction management plan for larger schemes (i.e. over 10 residential units or 1,000sq m of new commercial floorspace). However, occasionally a relatively large development will have comparatively little impact on its neighbourhood.
- 8.9 Conversely, small schemes on confined or inaccessible sites can have very significant impacts, particularly where the construction process will take place over a number of months (or even years) or outside normal working hours. When assessing smaller developments, special regard should be had to on-site factors that would seriously exacerbate the impact of the development works on the surrounding area. These could include development in residential areas, in close proximity to a school or a care home or very narrow or restricted site access (e.g. development in a mews with no footways). Regard will also be had to the nature and layout of a site. It will be much more difficult to fully absorb or contain the effects of demolition and construction in terms of noise, dust vibration etc within the boundaries of a small constrained site. Furthermore, lack of on-site space for plant, storage of materials and loading and unloading of construction may mean that construction effects will inevitably take place close to the boundary and spill out on to the highway network – a particular issue in much of Camden.
- 8.10 The types of schemes where a CMP will usually be appropriate include:
- Major developments (and some larger scale non major developments);
  - Development where the construction process has a significant impact on adjoining properties particularly on sensitive uses;
  - Developments which give rise to particular 'on-site' issues arising from the construction process (e.g. large scale demolition or complicated or intrusive remediation measures);
  - Basement developments;
  - Significant developments involving listed buildings or adjacent to listed buildings;
  - Developments that could seriously affect wildlife;
  - Developments that could cause significant disturbance due to their location or the anticipated length of the demolition, excavation or construction period;

- Development where site specific issues have arisen in the light of external consultation (where these are supported by objective evidence); and
- Development on sites where constraints arising from the layout or size of the site impact on the surrounding road network.

### **Contents of a construction management plan**

- 8.11 Any construction management plan will manage on-site impact arising from demolition and construction. It will also seek to establish control over construction traffic and how this integrates with other construction traffic in the area having regard to the cumulative effect.
- 8.12 A Section 106 or planning permission securing a construction management plan will contain provisions setting out in detail the measures the final version of the construction management plan should contain. Most construction management plans will be umbrella documents managing all impacts of the demolition, excavation and construction processes. This would include (but is not limited to) issues such as:
- Dust, noise and vibration on site and off site;
  - Traffic management highways safety and highways congestion;
  - Protection of listed buildings (if relevant);
  - Stability of adjacent properties;
  - Protection of any off-site features that may be damaged due to works;
  - Protection of biodiversity and trees; and
  - Preserve the amenity of surrounding residential and other sensitive uses.
- 8.13 A construction management plan is often split into two elements. The first element will be focussed on controlling environmental impacts, pollution and other non-highway related impacts arising from the scheme, having regard to the requirements of the Council's Considerate Contractor Manual and best practice guides from the GLA. In particular this will seek to control hours of operation and monitor and manage air quality, noise, dust and other emissions of other pollutants and location of equipment. The second element will be focussed on traffic control with a view to minimising disruption, setting out how construction work will be carried out and how this work will be serviced (e.g. delivery of materials, set down and collection of skips), with the objective of minimising traffic disruption and avoiding dangerous situations for pedestrians and other road users.
- 8.14 Sometimes the Section 106 will link the construction management plan with a requirement to convene a working group to act as a forum for the developer to meet with local residents and businesses to deal with construction issues as they arise.



- 8.15 Construction management plans will also have to be consistent with any other plans required for the development. For example, a Site Waste Management Plan, which is a legal requirement for works over a certain size which may require the re-use or recycling of materials on-site and therefore the construction management plan will have to reflect that space will be required to sort, store and perhaps crush or recycle materials.
- 8.16 The construction management plan should include the following statement:  
“The agreed contents of the construction management plan must be complied with unless otherwise agreed with the Council. The project manager shall work with the Council to review this construction management plan if problems arise in relation to the construction of the development. Any future revised plan must be approved by the Council and complied with thereafter.”

### **Transport considerations**

- 8.17 The details contained within a construction management plan will relate to the nature and scale of the development, however, in terms of assessing the impact on transport the plan should demonstrate that the following has been considered and where necessary the impacts mitigated:
- a) Start and end dates for each phase of construction;
  - b) The proposed working hours;
  - c) The access arrangements for vehicles;
  - d) Proposed routes for vehicles between the site and the Transport for London Road Network (TLRN). Consideration should also be given to weight restrictions, low bridges and cumulative effects of construction on the highway;
  - e) Sizes of all vehicles and the frequency and times of day when they will need access to the site, for each phase of construction;
  - f) Swept path drawings for any tight manoeuvres on vehicle routes to the site;
  - g) Details (including accurate scaled drawings) of any highway works necessary to enable construction to take place;
  - h) Parking and loading arrangements of vehicles and delivery of materials and plant to the site;
  - i) Details of proposed parking bays suspensions and temporary traffic management orders;
  - j) Proposed overhang (if any) of the public highway (scaffolding, cranes etc);
  - k) Details of any temporary buildings outside the site boundary, or overhanging the highway;
  - l) Details of hoardings required or any other occupation of the public highway;

- m) Details of how pedestrian and cyclist safety will be maintained, including any proposed alternative routes (if necessary), and any banksman arrangements;
- n) Details of how traffic associated with the development will be managed in order to reduce congestion;
- o) Arrangements for controlling the movements of large/heavy goods vehicles on and in the immediate vicinity of the site, including arrangements for waiting, turning and reversing and the provision of banksmen, and measures to avoid obstruction of adjoining premises.
- p) Details of any other measures designed to reduce the impact of associated traffic (such as the use of construction material consolidation centres);
- q) Details of how any significant amounts of dirt or dust that may be spread onto the public highway will be cleaned or prevented;
- r) Details of any Construction Working Group that may be required, addressing the concerns of surrounding residents, as well as contact details for the person responsible for community liaison on behalf of the developer, and how these contact details will be advertised to the community;
- s) A statement confirming registration of the site with the Considerate Constructors Scheme;
- t) How the servicing approach takes into consideration the cumulative effects of other local developments with regard to traffic and transport;
- u) Provision for monitoring of the implementation of the CMP and review by the council during the course of construction works;
- v) Any other relevant information with regard to traffic and transport; and

#### **Air quality and climate change considerations**

8.18 A method statement should be prepared and adopted as part of the construction management plan to minimise gaseous and particulate matter emissions generated during the Construction Phase. The following best practice measures shall be included in the method statement:

- Techniques to control PM<sub>10</sub> and NO<sub>x</sub> emissions from vehicles and plant;
- Techniques to control dust emissions from construction and demolition;
- Air quality monitoring; and
- Techniques to reduce CO<sub>2</sub> emissions from construction vehicles.

#### **How will we secure construction management plans?**

8.19 Generally a Section 106 agreement (rather than a condition) is the most appropriate mechanism for securing a construction management plan. For larger schemes or developments on constrained sites within heavily

built-up areas where building activities could materially affect the highway construction management plans will always be secured through Section 106s. While the use of conditions is normally preferred to Section 106 Agreements, conditions can only be used to control matters on land within the developer's control. The range of matters typically covered by a CMP, particularly in relation to highways, mean that a Section 106 Agreement will be necessary in most cases.

- 8.20 The level of detail contained in a typical Section 106 also lends itself to the tailored, site-specific approach Camden uses for construction management plans. However, the use of a condition to secure a construction management plan may be sufficient for sites where the building activities associated with the build out can be totally accommodated within the site itself, particularly where these are smaller schemes.

## 9 Access for all

### KEY MESSAGES:

- Well designed, accessible buildings and spaces ensure that local services and facilities are accessible to everyone and increase equality of opportunity and social inclusion. We will seek to ensure the highest standards of access and inclusion in Camden's built environment and public realm.
- We expect all development of buildings and places, including changes of use and alterations to or refurbishment of existing buildings where practical and reasonable, to be designed to be accessible and useable by all to promote equality of opportunity.
- Access should be considered at the beginning of the design process.

- 9.1 A successfully accessible and inclusive environment is one that everyone can benefit from by being able to move freely, independently and uninhibited within the built environment regardless of age or disability.
- 9.2 This guidance applies to all development in Camden that may affect the accessibility of buildings and spaces.
- 9.3 All new developments should incorporate a suitable level of access for everyone and be inclusively designed.
- 9.4 Changes of use, alterations and extensions to existing buildings and spaces should, where practicable and reasonable, be designed to improve access for all.
- 9.5 The planning system is not able to require existing buildings or areas to retrospectively improve access where alterations are not being made.
- 9.6 For developments involving housing, reference should also be made to Camden Development Policies policy DP6 – *Lifetime homes & wheelchair housing* and Camden Planning Guidance on Lifetime homes and wheelchair housing. The accessibility needs are lower for certain sectors of the population, such as students, and so the Council will assess each development proposal on its own merits to determine a suitable level of accessible accommodation to be provided.
- 9.7 Guidance on the provision of parking spaces for drivers with disabilities is contained in Camden Planning Guidance on Vehicle access.
- 9.8 This guidance provides general advice on accessibility and advises on further sources of more detailed information. In particular this guidance relates to Core Strategy policy CS14 - *Promoting High Quality Places and conserving our heritage*; CS6 - *Providing quality homes* and policy DP29 - *Improving access* of the Camden Development Policies.
- 9.9 It is more effective to consider access arrangements from the beginning of the design process as they are an integral aspect of building design.

Overcoming access barriers at a later stage in the project can result in a building or space that is not inclusive and may be inaccessible to many people.

- 9.10 Applicants are advised to consult the Council's Building Control Service at an early stage in the formulation of development proposals to ensure conformity with the relevant requirements relating to access. Satisfying some of the requirements of Part M of the building regulations can affect the size and design of the building and needs to be taken into account at the early design stage.
- 9.11 The following table sets out four key principles which, if put together successfully, should help create an accessible environment:

## Principles of access

Key Principle	Features to be considered
1. Approach  Parking	<ul style="list-style-type: none"> <li>• Level or adequately ramped</li> <li>• Sufficient width and obstacle free</li> <li>• Firm, durable, slip resistant surfaces</li> <li>• Well lit and clearly identified</li> <li>• Dropped kerbs with tactile surfaces</li> <li>• Contrasting colour on bollards and street furniture</li> <li>• Suitably designed and marked spaces</li> <li>• Spaces as close as possible to all accessible entrances</li> <li>• Dropped kerbs onto a level obstruction free route to the accessible entrance</li> <li>• Appropriately located and signed dropping off point</li> </ul>
2. Entrances  Lobbies  Receptions	<ul style="list-style-type: none"> <li>• Level or adequately ramped and stepped if necessary with appropriately designed handrails</li> <li>• Ramped gradients as shallow as possible</li> <li>• Level area in front of the door</li> <li>• Level threshold</li> <li>• Canopy over manual doors</li> <li>• Easy to open doors</li> <li>• Provision of electronic entrance doors</li> <li>• Sufficiently wide doors</li> <li>• Doors to have contrast.</li> <li>• Need to be of a size and shape to allow a wheelchair user to move clear of one door before opening the second door</li> <li>• Floor surface that does not impede movement, avoid dips or changing surfaces, including mats</li> <li>• Provide hearing enhancement systems and lowered wheelchair accessible counters.</li> <li>• Should be easily identifiable</li> </ul>
3. Levels  Circulation	<ul style="list-style-type: none"> <li>• Provide a lifting device and suitable stairs to all storeys above and below ground</li> <li>• Ramps for internal changes within a storey</li> <li>• Any raised areas to be accessible to everyone</li> <li>• Adequately wide corridors.</li> <li>• Sufficiently wide doors</li> <li>• Clear, well lit signs</li> <li>• Colour contrast within the building</li> <li>• Corridors free of obstructions</li> </ul>
4. Facilities	<ul style="list-style-type: none"> <li>• Adequate provision of wheelchair accessible unisex toilets</li> <li>• Provision of an enlarged cubicle in separate sex toilets</li> <li>• Where shower and changing facilities are included provide wheelchair accessible facilities</li> <li>• Provision of wheelchair accessible hotel bedrooms</li> <li>• Appropriately designed sockets and switches</li> </ul>

### Additional information

- 9.12 Level access should be provided to the principal entrance in all developments, and is a requirement for all new dwellings. Any new works must not make access any worse than what may have previously existed, in line with Approved Document M of the Building Regulations.
- 9.13 The design of routes around buildings should be clear and free from obstruction, especially to the entrance. Any obstructions should be made clear and avoidable, for example by changes in surface texture.
- 9.14 The above access principles apply mainly to non-residential developments – although the first two will also be applicable to residential developments. In the case of residential development, proposals must meet Lifetime Home Standards as set out in policy *DP6 – Lifetime Homes and wheelchair homes* of the Camden Development Policies. Reference should also be made to Camden Planning Guidance 2 and the section on Lifetime Homes and wheelchair housing.

### Design and Access Statements

- 9.15 A Design and Access Statement is a short written and illustrated report which accompanies and supports a planning application. It explains the thinking behind a design and its context in a proposal in a structured way. A Design and Access Statement should:
- Show how the applicant has analysed the site, its setting, and as a result of this assessment, formulated and applied design principles to achieve a good, inclusive design for buildings and public spaces;
  - Include the specific needs of disabled people, by showing how they have been integrated into the proposed development, and how inclusion will be maintained and managed; and
  - Be flexible, adaptable and be able to change with the design of the proposal should any amendments or changes occur.
- 9.16 The level of detail appropriate in an access statement will depend on the size, nature and complexity of the proposal, as a minimum, all should include:
- A short illustrated statement setting out the site and context appraisal, the purpose of the proposed development, a list of design principles and a description of the proposal explaining how the design responds to the appraisal and design principles;
  - A plan of the site, surrounding area or natural form and key features as identified in the appraisal;
  - Annotated sketches and photographs;
  - Important elements of the context that inform the design principles;
  - Plans and elevations of the proposal;
- 9.17 The following points should be taken into account when preparing a Design and Access statement:

- A brief explanation of the applicant's approach to access, with particular reference to the inclusion of disabled people;
- A description of how the sources of advice on accessibility and technical issues will be, or have been, followed;
- Details of any consultations undertaken or planned, including the number of users, particular user need groups (for example, visually impaired, deaf or hard of hearing, ethnic groups, people with learning disabilities and mental health) and the degree to which the process has been influenced by it;
- Details of any professional advice that has been followed, or will be sought, including recommendations from access audits or appraisals;
- An explanation of any specific issues affecting accessibility to, or within, the particular environment being considered, and/or service provision, employment or educational opportunities.
- Details of access solutions adopted to overcome any issues, including those which deviate from recognised good practice;
- Details of the management and maintenance practices adopted, or to be adopted, to maintain features enhancing accessibility (for example, lighting, colour and luminance contrast, door closing forces etc), specialist equipment (for example, induction loops, audible and visual fire alarm systems etc), and staff training; and
- A plan illustrating features such as routes in, out and around the outside of the building, vertical and horizontal circulation routes, positions of accessible car parking bays, the location of public transport, and any other features relevant to the proposal.

9.18 Where good practice cannot be met, the Access Statement should say why this is the case, set out the implications for users, and explain what other measures are being taken to ensure access is provided to the facilities available. See Further Information at the end of this section for links to more detailed guidance.

### **Listed buildings**

- 9.19 Design and access statements are also required for a listed building consent. Where a planning application is submitted in parallel with an application for listed building consent a single combined statement can be submitted which should address the requirements for both.
- 9.20 Measures to facilitate dignified and easy access to and within listed buildings can often be sensitively incorporated without damage to their special architectural or historic interest. However, the Disability Discrimination Act 1995 does not override other legislation such as listed building or planning legislation. Listed Building Consent will almost always be required for works to improve access and in formulating proposals; applicants are encouraged to undertake early discussions with the Council.



- 9.21 English Heritage has produced guidance on this topic titled Easy Access to Historic Buildings (see Further Information for the link). Additional information is also contained in Circular 01/06.

**Other considerations**

- 9.22 Applicants should note that Design and Access Statements differ from the requirements for Access statements set out in Approved Document M of the Building Regulations, which are only required when specific building control regulations can not be met. Approved Document M of the Building Regulations sets out the requirements to ensure access to and use of a building's facilities are accessible to all.
- 9.23 It may also be appropriate to combine the Design and Access Statements with other statements requested in other sections of Camden Planning Guidance, provided that the requirements of all such statements are adequately addressed.
- 9.24 Part 3 of the Disability Discrimination Act 1995 gives disabled people a right of access to goods, facilities and services. This requires service providers to:
- Alter a barrier feature so that it no longer has effect;
  - Provide a reasonable means of avoiding that feature; or
  - Provide a reasonable alternative method of making the service available.
- 9.25 These requirements apply to all buildings where services are provided to the public and to transportation infrastructure.

## Further information

Design and Access Statements	<p>Department for Communities and Local Government (March 2010) Guidance on information requirements and validation:  <a href="http://www.communities.gov.uk/publications/planningandbuilding/validationguidance">www.communities.gov.uk/publications/planningandbuilding/validationguidance</a></p> <p>ODPM publication: Planning and Access for Disabled People: A Good Practice Guide  <a href="http://www.communities.gov.uk/publications/planningandbuilding/planningaccess">www.communities.gov.uk/publications/planningandbuilding/planningaccess</a></p> <p>Department for Communities and Local Government Circular 01/2006: Guidance on Changes to the Development Control System: Section 3 provides guidance on the legislative position and information required  <a href="http://www.communities.gov.uk/publications/planningandbuilding/circularcommunities2">www.communities.gov.uk/publications/planningandbuilding/circularcommunities2</a></p> <p>The Commission for Architecture and the Built Environment (CABE) 'Design and access statements: how to write, read and use them'  <a href="http://www.cabe.org.uk">www.cabe.org.uk</a></p> <p>Mayor of London's Supplementary Planning Guidance: Accessible London: Achieving an Inclusive Environment  <a href="http://legacy.london.gov.uk/mayor/strategies/sds/docs/spg_accessible_london.pdf">http://legacy.london.gov.uk/mayor/strategies/sds/docs/spg_accessible_london.pdf</a></p>
Access and the historic environment	<p>English Heritage have published guidance on 'Easy Access to Historic Landscapes' and 'Easy Access to Historic Buildings' which can be found on their website at:  <a href="http://www.english-heritage.org.uk/publications/easy-access-to-historic-buildings/">www.english-heritage.org.uk/publications/easy-access-to-historic-buildings/</a></p>
Lifetime Homes and wheelchair housing standards	<p>Lifetime Homes  <a href="http://www.lifetimehomes.org.uk">www.lifetimehomes.org.uk</a></p> <p>Accessible London: Achieving an Inclusive Environment, GLA (April 2004)</p>



## 10 Wind and micro-climate

### KEY MESSAGES:

- Buildings taller than their surroundings may cause excessive wind in neighbouring streets and public areas.
- New developments should consider the local wind environment, local temperature, overshadowing and glare, both on and off the site.
- Where poor wind conditions already exist reasonable attempts must be made to improve conditions generally.

- 10.1 The construction of a building changes the microclimate in its vicinity. Micro-climate refers to local conditions including wind, temperature, overshadowing, access to daylight and general comfort. In particular high-rise buildings can cause high wind velocities at pedestrian level which can create an uncomfortable environment and can even be dangerous. Therefore, the design of your building should not only focus on the building envelope and on providing good indoor environment, but should also include the effect of the design on the surrounding outdoor environment.
- 10.2 The purpose of this guidance is to ensure that appropriate standards are met in the design of buildings and outdoor features to ensure that suitable wind safety and comfort levels are achieved.
- 10.3 This guidance relates to Core Strategy CS14 - *Promoting high quality places and conserving our heritage* and policy DP24 - *Securing high quality design* of the Camden Development Policies.

### When does this guidance apply?

- 10.4 This guidance applies to all development that has the potential to change their environment with regard to wind and micro-climate, whether new build or extension. However, the implications for a proposal will vary greatly depending on the nature of the site, the scale of development, its interaction with surrounding sites, and existing buildings and structures on the site.

**DEVELOPMENTS LARGE ENOUGH TO CHANGE THEIR LOCAL ENVIRONMENT WILL INCLUDE:**

- New or modified buildings that are 18 metres or 5 storeys higher than any surrounding building;
- Significant modifications to the built environment in areas of quantifiable and recognised existing wind nuisance;
- Major proposals adjacent to or incorporating a significant area of public or outdoor space;
- Developments with a large amount of glazing or dark masonry surfaces; or
- A combination of new or modified buildings that cumulatively, will significantly change the wind environment.

**Wind environment around buildings**

- 10.5 Buildings taller than their surroundings may cause excessive wind in neighbouring streets and public areas. Environmental winds are primarily driven by building massing and should be considered at the early design stages, when changes to achieve design objectives can be made most easily.
- 10.6 We will expect you to consider the local wind environment when designing your scheme, both on and off the site. Where poor wind conditions exist in the area prior to development, a reasonable attempt must also be made to improve conditions in general.

**What information should I provide?**

- 10.7 Relevant developments are expected to use the Lawson Comfort Level Ratings (set out below). Areas that must be considered are:
- public and private open spaces on and adjacent to the site;
  - outdoor areas on upper levels of the development;
  - entrance and exit areas;
  - shop windows;
  - bus stops;
  - outdoor dining areas;
  - thoroughfares; and
  - pedestrian crossing points.

- 10.8 The Lawson Criteria are used throughout the UK to assess local wind environments and are a widely accepted assessment tool.

**The Lawson Comfort Criteria**

The Lawson Comfort Criteria is a scale for assessing the suitability of wind conditions in the urban environment based upon threshold values of wind speed and frequency of occurrence. It sets out a range of pedestrian activities from sitting through to crossing the road and for each activity defines a wind speed and frequency of occurrence. If the wind conditions exceed the threshold then the conditions are unacceptable for the stated activity.

**Figure 1. Lawson Comfort Level Rating**

<b>Lawson Comfort Level Rating</b>	<b>Predominant activity</b>	<b>Mean hourly wind speed exceeded less than 5% of the time</b>
C4 - Long term "Sitting"	Reading a newspaper and eating and drinking	4m/s
C3 - "Standing" or short term sitting	Appropriate for bus stops, window shopping and building entrances	6m/s
C2 - Pedestrian Walking or "Strolling"	General areas of walking and sightseeing	8m/s
C1 - Business "Walking"	Local areas around tall buildings where people are not expected to linger	10m/s

- 10.9 If this applies to your development your planning application should be accompanied by qualitative wind impact statement, prepared by a suitably qualified professional (i.e. wind engineer or similar).
- 10.10 You must firstly carry out a qualitative wind impact assessment. If the results of this show potential negative impacts you will also need to carry out a quantitative assessment. Both assessments must be submitted with your planning application. Your assessment must provide detailed information on how the proposal meets the criteria in the guidance, using quantitative measures (i.e. evidence of wind tunnel testing or similar).

**Your Wind Impact Statement must:**

- Show how the proposal is expected to affect the local wind environment;
- Describe how the proposal has addressed the local wind environment;
- Include reference to specific features of the site or the development that make a contribution to the wind environment, either positively or negatively, and highlight areas of concern; and

- Reference the proposal's ability to meet the targets of this guidance, and make recommendations regarding the necessity for additional work, as described below.

**Your Wind Impact Statement should:**

- Compare existing and proposed conditions against the Lawson Comfort Criteria in both summer and winter conditions;
  - Demonstrate how the proposal has adapted to the local wind environment;
  - Reference specific features of the site or the development that make a contribution to the wind environment, both positively or negatively;
  - Highlight areas of concern, and
  - Describe the proposal's ability to adhere to the guidance.
- 10.11 If your proposal does not achieve the targeted ratings or outcomes you must provide sound justification to demonstrate, to the satisfaction of the Council, why your proposal cannot meet the targets. This justification should be prepared in conjunction with, and endorsed by your wind engineer, and must include evidence of the attempts that have been made to address design deficiencies.
- 10.12 If your proposal does not satisfactorily meet the criteria, and you have not provided justification, your proposal may be refused.
- 10.13 A condition may be imposed to secure the achievement of wind speed(s) around the building no greater than those predicted. The Council may require alterations or other remedial measures at the developer's expense if wind speed targets are not met.

**Other considerations relating to the wind environment**

- 10.14 Your development must not compromise the viability of wind-driven renewable energy generators on adjacent and nearby sites. Where wind-driven energy generators are likely to be significantly affected, you are responsible for ameliorating the loss by moving, modifying or replacing the installation, or by incorporating equivalent renewable energy generation within your site.
- 10.15 Where a development affects the viability of an existing wind-driven renewable energy generator, and the solution is to modify the installation off-site, all approvals, expenses and risks are the responsibility of the applicant. This requirement will be incorporated as a condition or in a S106 agreement relating to any approval. Where additional renewable energy capacity is to be installed on site, this will be assessed in conjunction with other renewable energy installations. (Note: additional capacity that is gained by installations off-site should be credited toward the onsite requirement for the development)
- 10.16 Wind environment also impacts on natural ventilation systems. Natural ventilation must also be considered in building design.

## Other influences on micro-climate

### Local heat

- 10.17 Local air temperature can be affected by your building's ability to absorb heat during the day and release it at night. This cumulative effect of this happening across London results in the urban heat island effect. We strongly encourage green roofs, brown roofs, green walls and soft landscaping in all developments to reduce this affect. You can also consider light coloured building materials so unnecessary heat is not absorbed by your building. See Camden Planning Guidance 3 – Sustainability for further guidance on these issues.

### Overshadowing

- 10.18 You should consider the design of your proposal carefully so that it does not overshadow windows to habitable rooms or open spaces and gardens. This may be particularly difficult in central London. However, it will be particularly important in Central London to prevent overshadowing of amenity space and open spaces given the limited amount of open spaces and the existing amount of overshadowing.

### Glare

- 10.19 Glare is uncomfortably bright sunlight reflected from a building façade. It is generally caused by tall, fully glazed and sloping facades with reflective finishes that reflect the sun. Tall buildings should be designed to avoid this and use materials that do not result in glare.

### Further information

General guidance on design principles	By Design: Urban Design in the Planning System – Towards Better Practice, DETR/CABE, 2000
Tall buildings	Guidance on tall buildings, English Heritage/CABE, 2007
Urban design in relation to the historic environment	Understanding Place, English Heritage 2010; and Building in Context, English Heritage/CABE, 2002





## 11 Open space, outdoor sport and recreation facilities

### KEY MESSAGES:

- If your scheme is over a certain size it is expected to make a contribution towards the provision of public open space in the borough;
- Our priority is for the provision of public open space on-site, therefore it is important this is taken into account at the design stage of your scheme;
- Other forms of public open space contributions could be provision off-site or as a payment in lieu.

- 11.1 This guidance gives details of how the Council expects development to provide for a variety of public open space, outdoor sport and recreation facilities. It sets out:
- Which developments are expected to make provision for open space, outdoor sport and recreation opportunities;
  - The amount of open space we expect;
  - The type of open space and outdoor sport and recreation facilities we expect;
  - How we will calculate the open space expected for a specific development; and
  - The Council's priorities for how open space, outdoor sport and recreation facilities will be provided.

- 11.2 This guidance primarily relates to:

#### Core Strategy Policies:

- CS5 – Managing the impact of growth
- CS15 – Protecting and improving our parks and open spaces and encouraging biodiversity

#### Development Policies:

- DP26 – Managing the impact of development on occupiers and neighbours
- DP31 – Provision of, and improvements to, open space and outdoor sport and recreation facilities.

### **Which developments are expected to contribute towards open space, outdoor sport and recreation facilities?**

- 11.3 As set out in paragraph 31.6 the Camden Development Policies document you will need to make a contribution to the provision of these facilities in the borough if your development falls within the following categories:

- Five or more additional dwellings;
- Student housing schemes creating an additional 10 or more units/rooms or occupiers; and
- Developments of 500sq m or more of any floorspace that are likely to increase the resident, worker or visitor populations of the borough.



### How much open space do we expect?

- 11.4 Development Policy *DP31 – Provision of, and improvements to, open space and outdoor sport and recreation facilities* sets out the amount of open space to be provided by developments as follows:

**Figure 2. Amount of open space to be provided by land use**

Development type	Open space provision
Residential (all types)	9 sq m per occupier
Commercial development	0.74 sq m per worker

- 11.5 Non-residential developments for higher education are considered to generate requirements per occupier (including employees and students) at the same rate as commercial developments.

### What types of open space, outdoor sport and recreation facilities will we expect?

- 11.6 Open space standards relate specifically to public open space. The Council acknowledges the private amenity space and other private open land can reduce pressure on the use of public open space. However public open spaces provide opportunities for social interaction and a focus for community activities. Private spaces cannot be used as a substitute for public open space.

- 11.7 Public open space includes a wide variety of different facilities that are available to the public:
- Green amenity spaces, including natural and semi-natural spaces;
  - Active spaces for outdoor sport and recreation and for children’s play; and
  - Civic spaces.
- 11.8 Green amenity spaces can be formal or informal parks and gardens or other landscaped areas, which provide areas of passive recreation for all age groups and attractive green areas within the urban environment. They are intended to be attractive spaces for people to enjoy using or viewing. This type of open space can include areas of natural or semi-natural green spaces, which support wildlife conservation and biodiversity and promote environmental education and awareness.
- 11.9 Active spaces are areas of grassed or artificial surfaces providing opportunities for sport and recreation together with ancillary facilities such as changing rooms and flood lighting. These include playing pitches, courts, greens, athletic tracks and Multi Use Games Areas (MUGAs). Formal recreation areas may be stand-alone facilities or may form part of a larger open space (e.g. the tennis courts and bowling greens at Hampstead Heath).
- 11.10 Civic spaces are hard surfaced areas designed for pedestrians, such as piazzas, which often provide a setting for civic buildings.
- 11.11 Given the amount of hard surfaces in Camden, our priority will generally be for green spaces, especially in the south of the borough. Paragraphs 11.12 to 11.17 give more details of specific types of public open space.

### **Children’s play space and young people’s recreation space**

- 11.12 These are formal or informal areas designed to engage children or young people. Formal spaces are designated areas for children and young people containing a range of facilities and an environment that has been designed to provide focused opportunities for outdoor play. There are three categories of formal children’s play space defined by the National Playing Fields Association (NPFA).
1. LAP - Local Area for Play;
  2. LEAP - Local Equipped Area for Play;
  3. NEAP - Neighbourhood Equipped Area for Play.
- 11.13 Informal spaces are less well defined areas and can be incorporated into smaller spaces such as local footpaths where wide enough or town centre spaces. It involves incorporating features that children can play with such as fountains or objects to climb.
- 11.14 Contributions to children’s play space and young people’s recreation space can include formal and informal areas. We must be satisfied that any informal space has been sufficiently designed to meet the requirements of children and young people.

### **Natural and semi-natural green spaces**

- 11.15 These include sites and areas formally recognised for their nature conservation value such as Sites of Special Scientific Interest, Sites of Nature Conservation Importance and Local Nature Reserves as well as other areas with biodiversity such as gardens, parks and open spaces.
- 11.16 In exceptional circumstance, generally in areas deficient in nature conservation sites, we may consider the inclusion of a biodiverse green roof, brown roof or green wall as a contribution towards natural and semi-natural green spaces in the borough. For more information about areas of deficiency please see Appendix A to this section. For more information about green roofs, brown roof and green walls please see Camden Planning Guidance 3 – Sustainability.

### **Allotments and Community Gardens**

- 11.17 Allotments and community gardens provide opportunities for people to grow food as part of the long term promotion of sustainability, health and social inclusion.

### **What type of open space, outdoor sport and recreation facilities are expected for specific development types?**

- 11.18 For this guidance, and in line with *Camden's Open space, Sport and Recreation Study Update 2008* we have identified the following five broad categories of open space:
- Public amenity open space;
  - Children's play space and young people's recreation space;
  - Natural and semi-natural green space;
  - Allotments and community gardens; and
  - Outdoor sport and recreation.
- 11.19 We recognise that not every type of development will generate a need for all types of open space, outdoor sport and recreation facilities. For example, housing for older people will not generate demand for children's play space. Figure 3 sets out the types of open space that are likely to be needed for various types of development.

**Figure 3. Type of open space to be provided by development**

	Amenity open space	Children's playspace	Natural green-space	Outdoor sport facilities	Allotments / Community gardens
Self-contained homes (Use Class C3)	✓	✓	✓	✓	✓
Student housing	✓	x	✓	✓	x
Housing for older people	✓	x	✓	x	✓
Commercial	✓	x	✓	✓	x

Source: adapted from Camden Open Space, Sport and Recreation Study Update 2008.

- 11.20 The requirement for 9 sq m of public open space per residential occupier and 0.74 sq m of public open space per employee/ student (commercial/ higher education developments) should generally be divided into different types of open space approximately as set out in Figure 4.
- 11.21 In Camden the potential to add to outdoor sports facilities for adults is limited. Provision for outdoor sports will be sought within the overall requirement of 9 sq m per residential occupier where an opportunity for provision arises. Where a development provides public facilities for outdoor sports these will reduce the requirement for other types of open space.
- 11.22 The Camden Open Space, Sport and Recreation Study Update 2008 derived a separate standard for allotments of 0.9 sq per residential occupier. The study indicated that additional space to grow food could only be provided by taking a flexible approach including community gardens, roof gardens, temporary use of vacant sites and converting parts of existing open spaces. Although the standard is not included within the 9 sq m overall requirement, paragraph 31.7 of the Camden Development Policies document indicates that allotments and community gardens are a Council priority. Provision will be sought wherever an opportunity arises, and will be considered to reduce the requirement for other types of open space.

**Figure 4. Break down of open space by type of provision  
Residential Developments (all types)**

Type of open space	Provision per adult	Provision per child
Amenity open space	5 sq m	4 sq m
Children's playspace (where applicable)		2.5sq m
Natural green space	4 sq m	2.5 sq m

**Commercial / higher education (non-residential)**

Type of open space	Provision
Amenity open space	0.4 sq m per person
Natural green space	0.34 sq m per person

**How we will calculate the open space expected for a specific development**

- 11.23 Figure 5 below shows the figures we will use to assess open space requirements for individual residential, commercial and higher education developments. The figures are based on the break down of open space requirements in Figure 4 and the occupancy rates recommended by the Camden Open Space, Sport and Recreation Study Update 2008. The occupancy rates are given in Appendix B to this section.

**Figure 5. Open space required for specific developments**

Self-contained homes in Use Class C3	Amenity open space	Children's play space	Natural green space	Total
One bedroom home	6.5 sq m		5.2 sq m	11.7 sq m
Two bedroom home	9.2 sq m	0.6 sq m	7.2 sq m	17.0 sq m
Three bedroom home	12.8 sq m	2.9 sq m	9.5 sq m	25.2 sq m
Four bedroom home	14.1 sq m	3.6 sq m	10.2 sq m	27.9 sq m
<b>Student housing, hotels and hostels</b>				
Single room	5.0 sq m		4.0 sq m	9.0 sq m
Double room	10.0 sq m		8.0 sq m	18.0 sq m
<b>Commercial/ higher education development</b>				
Per 1,000 sq m gross external area	21.6 sq m		17.9 sq m	38.9 sq m

- 11.24 Appendix D sets our worked examples showing the open space required for a number of different development types and sizes.

## **How public open space will be provided**

11.25 There are three ways in which you can make a contribution to public open space in Camden:

1. On site provision of new public open space;
2. Off site provision of new public open space;
3. Providing a financial contribution in lieu of direct provision.

### **On site provision of new public open space**

11.26 If your development is located in an area deficient in public open space or with an under provision of public open space we expect provision of new public open space on the development site (see Appendix A to this section and Core Strategy Map 7). This is in accordance with paragraph 31.7 of the Camden Development Policies document. Paragraph 31.7 and accompanying Table 1 also set out other developments that are expected to provide open space on-site. Some on-site provision is expected for residential development adding 60 or more homes and commercial development adding 30,000 sq m or more.

11.27 The amount and type of public open space that can be achieved on-site will be determined by the size of the site. Where children's play facilities are required as a result of the development, priority should be given to the provision of these facilities. On sites already covered by development, and where appropriate access may have to be restricted to the occupiers of the building, the provision of a roof garden as a contribution to public open space may be considered. If a roof garden is to be considered as public open space, as a minimum it should be able to be used by all the occupants of the building.

11.28 Any new public open space that is provided as part of your development should be:

- Large enough to cater effectively for the intended users;
- Designed to be fully accessible, where possible;
- Designed in consultation with the Council's Open space team; and
- Practical to maintain.

11.29 Where you are required to make a contribution to public open space we will ensure that the type of open space you provide best meets the needs of the occupiers or users of the development. You should consider designing your open space carefully to enable different types of open space to be located together or adjacent to each other to complement the overall provision of open space, sport and recreation opportunities.

11.30 We will expect new open space provision to be publicly accessible, however in exceptional circumstances, for example where an existing open space is in private ownership or already has restricted access we may accept an alternative access arrangement.



### **Off site provision of new public open space**

- 11.31 Where a site cannot provide public open space on-site, the preferred option will be provision of new suitable open space off-site. Once again this is especially important where a site does not have access to existing open space in accordance with the distance thresholds (see Appendix A to this section). The new provision should be within the distance threshold for the type of public open space to be provided. For example, if a developer is to provide a children's play area of 100 sq m this should be provided within 50 m walking distance of the development, if amenity open space is to be provided, this should be a maximum of 280 m from the development. If the developer is to provide for a new formal recreation area such as a multi-use games area, this should be provided within 1,200 m of the development.
- 11.32 We will accept the provision of public access to an existing open space that currently has restricted access as a contribution to off-site public open space provision.

### **Providing a financial contribution in lieu of direct provision**

- 11.33 The Council may agree to accept financial contributions in place of direct provision of new public open space where the development site is too small to incorporate on-site open space and the densely built up character of Camden prevents direct provision of off-site public open space. Financial contributions may be used for:
- The creation of an area of public open space, including buying additional land or leasing it at a nominal rate;
  - Improving access to existing public open space;
  - Opening up access to existing private open space;
  - Fit out of a new or existing open space, or some elements of the open space; and
  - Qualitative improvements to existing open space.
- 11.34 Financial contributions may be pooled to create, fit out, improve or provide access to open space. For example, where the Site Allocations Document indicates that new public open space is required on a development site, contributions from other developments within 280 m may be pooled to facilitate the creation of the new public open space.
- 11.35 Financial contributions are calculated on the basis of the costs and requirements set out in Figure 6.. We will aim to spend the collective amount in the proportions set out in Figure 6 and within the same ward as the contributing development where possible. However individual financial contributions will be spent on priorities identified in:
- Camden's open space, sport and recreation study update 2008;
  - Camden's open space strategy;
  - Camden's biodiversity action plan;
  - Camden's play strategy;
  - Camden's sport strategy;

- Individual park management plans.

11.36 A financial contribution is based on the:

- Capital cost of providing new public open space;
- Cost of maintenance for the first 5 years; and
- Cost for the open space team to administer the contribution and design schemes.

**Figure 6. The financial contributions**

	<b>Capital cost</b>	<b>Maintenance</b>	<b>Design and admin</b>
<b>Self-contained homes in Use Class C3</b>			
One bedroom home	£385	£386	£46
Two bedroom home	£663	£561	£80
Three bedroom home	£1,326	£832	£159
Four bedroom home	£1,537	£921	£184
<b>Student housing, hotels and hostels</b>			
Single room	£297	£297	£37
Double room	£593	£594	£71
<b>Commercial/ higher education development</b>			
Per 1,000 sq m	£1,265	£1,284	£152

- 11.37 These aggregate contributions are based on provision of public open space, natural green space and (where applicable) children's play space. Specific contributions to allotments and community gardens and to outdoor sport and recreation provision will be sought on a case by case basis depending on whether there are opportunities to add to provision or are local facilities that need to be maintained.
- 11.38 The calculation of the aggregate contributions is set out in Appendix C to this section. Appendix C includes break down of the capital cost by open space type. This may be needed for developments where a proportion of the open space requirement is met on site or where adequate open space of some types is already available locally.
- 11.39 Payments for maintenance and design and administration are explained in paragraphs 11.45 to 11.50. They have not been aggregated with capital costs as payments will sometimes be required need to be calculated separately (eg where open space will be provided by the developer but maintained by the Council. The Council may also wish to draw separately on funds for capital works, funds for maintenance and funds for design and administration.
- 11.40 The contributions may be adjusted upwards or downwards according to the particular circumstances of the development. They provide a starting

point for negotiations between the Council and developers. The scale of financial contributions will be reviewed and updated as appropriate.

- 11.41 Appendix D to this section sets out worked examples showing the contributions required for a number of different development types and sizes.

### **Providing a combination of open space provisions**

- 11.42 Your development may contribute to public open space through one of the ways listed above or by a combination of them. To determine the amount and type of public open space you are expected to provide, either on-site or off-site we will consider the:

- Type and size of the existing public open space provision within the distance threshold of your development; and
- Size and likely users of your development.

- 11.43 For example, if you propose a residential development located within 280 m of a small local park you may not be required to contribute to amenity open space, but may still be required to contribute to children's play facilities or a formal recreation area if suitable facilities do not exist within the distance threshold of the development.

- 11.44 In all cases a legal agreement will be required to secure the ongoing use of the open space provided as public open space, or to secure the financial contribution in lieu of direct provision.

### **Maintenance**

#### **On or off-site provision**

- 11.45 Where you provide a contribution towards public open space outdoor sport or recreation facilities (either on-site or off-site), the Council will need to be satisfied that it has been properly laid out and completed and that suitable contractual arrangements for its long-term maintenance have been put in place. If you provide new public open space (either on-site or off-site) you will be expected to transfer the space to the Council to maintain and retain for such use.

- 11.46 Where your new public open space is to be transferred to us, you will normally be required to remain responsible for its maintenance for an initial establishment period of 5 years. After this time, we will take full responsibility for the maintenance of that public open space.

#### **Financial contribution**

- 11.47 If you make a financial contribution in lieu of direct provision, whether it is for substantial qualitative or accessibility improvements to existing sites already maintained by the Council or for the provision of a new public open space, we will expect you to provide a commuted sum for the maintenance of these facilities for a period of five years.
- 11.48 Where your new public open space is not to be transferred to the Council a commuted sum for maintenance will not be required. However,

if you choose to retain control of your public open space, we will need to be sure that adequate provision for the maintenance and access of that public open space is in place.

- 11.49 In ALL cases a legal agreement will be required to secure the maintenance of public open space over a defined period or to secure the financial contribution in lieu of direct maintenance.

### **Design and administration**

- 11.50 For payments in lieu of providing public open space, on-site or off-site payments we will also require a 12% contribution towards the costs of our open space team to administer the financial contribution and to plan and design works within our open spaces.

### **Further information**

Open Space, Sport And Recreation Study	Camden's open space, sport and recreation study update 2008 provides an assessment of open space, sport and recreation provision and demand in the borough. <a href="http://www.camden.gov.uk/planning">www.camden.gov.uk/planning</a>
Biodiversity Action Plan	Camden's Biodiversity Action Plan provides Camden's priorities for improving our greenspaces and biodiversity. <a href="http://www.ukbap-reporting.org.uk/plans/lbap.asp">www.ukbap-reporting.org.uk/plans/lbap.asp</a>
PPS17	Planning Policy Guidance 17 – Planning for open space and its companion guide provide policy and guidance for the provision of open space including the quantitative and qualitative considerations. <a href="http://www.communities.gov.uk">www.communities.gov.uk</a>
Mayor of London's Supplementary Planning Guidance	The Mayor of London's Supplementary Planning Guidance Providing for children and young people's play and informal recreation provides guidance and examples of how to incorporate space for children and young people. <a href="http://legacy.london.gov.uk/">http://legacy.london.gov.uk/</a>

## Appendix A

### Public Open Space Deficiency

Figure 7 shows the maximum distance that people can reasonably be expected to travel on a regular basis to use different types of open space. Amenity open space and children's play space should be available within easy walking distance of the development to which they relate. People are generally willing to travel further to use recreation areas providing outdoor sport facilities or to larger parks.

**Figure 7. Distance threshold for different types of public open space**

Type of public open space	Minimum size (where applicable)	Distance from development to public open space
Public amenity open space		280m*
Formal recreation area		1.2 km
<b>Play Space</b>		
LAP	100sq m	50m*
LEAP	400sq m	280m*
NEAP	1000sq m	500m*
Natural greenspace	Any	500m
Allotments and community gardens	Any	Any

\*This distance is the actual walking distance, taking into account local circumstances, such as the location of entrance gates, street patterns, the severance effects of railway lines or heavy traffic flows that could all reduce the accessibility of open spaces.

(Based on Guide to preparing Open Space Strategies: Best practice guidance of the London Plan, Mayor of London, 2002)

Camden Core Strategy Map 7 shows areas of the borough that are deficient in public open space.

#### AREAS DEFICIENT IN PUBLIC OPEN SPACE

Areas more than 280m walking distance away from a public open space with a multi-functional role, that is a space over 0.25ha (2,500sq m).

Core Strategy policy CS13 also refers to areas with an under-provision of open space. These are areas with access to open space, but the provision is not sufficient to meet the level of local need due to the number of children, dwelling density, and social disadvantage in the area. These are shown in Figure 4.4 of Camden's Open Space, Sport and Recreation Study Update.

Both components are needed to ensure that everyone is within an appropriate distance of public open space based upon their needs and to ensure that people are not prevented from accessing that open space as a result of prohibitive costs. Contributions to open space will be

encouraged within the distance thresholds for the particular type of open space to be provided.

Paragraph 15.18 of Camden's Core Strategy indicates that residents and visitors further than 1 km away from a metropolitan or borough Site of Nature Conservation Importance (SNCI) are considered to have poor access to the natural environment. Core Strategy Map 8 shows all areas greater than 500 m from an SNCI as deficient in access to nature conservation areas.

#### **AREAS DEFICIENT IN NATURE CONSERVATION SITES**

Areas more than 500m walking distance away from a Borough or Metropolitan level Site of Nature Conservation Interest.

## Appendix B

### Occupancy rate by development type

The Camden Open Space, Sport and Recreation Study Update 2008 recommends calculating occupancy rates and child yields on the basis of the London Housing Survey 2002 and DMAG briefing 2005/25. The occupancy rates are shown in Figure 8.

**Figure 8. Occupancy rate for C3 homes based on the London Housing Survey and DMAG briefing 2005/25**

<b>Self-contained homes in Use Class C3</b>	<b>Total persons</b>	<b>Children (average)</b>	<b>Adults (net)</b>
One bedroom home	1.3	0.04*	1.3
Two bedroom home	1.9	0.25	1.65
Three bedroom home	2.8	1.15	1.65
Four bedroom home	3.1	1.44	1.66

Source: Camden Open Space, Sport and Recreation Study Update 2008.

\*The average child yield for a one bedroom home equates to 1 child per 25 homes, which would not generate a meaningful play space requirement, and has been treated as 0.

Occupancy rates for student housing, hotels and hostels are assumed to be one person per single bedroom and two people per double bedroom.

The study recommends assuming an employee density of one worker per 19 sq m (gross external area) for commercial floorspace. This generates an occupancy rate of 52.6 employees per 1,000 sq m (gross external area). Non-residential developments for higher education are considered to generate the same number of occupants (including employees and students) as commercial developments.

## Appendix C

### Calculation of financial contributions

This appendix shows how we have calculated the financial contributions for provision or enhancement of public open space.

In addition to this capital cost, you will be expected to pay a commuted sum to cover:

- Maintenance of the facility and open space provision over a 5 year period; and
- Designing the new open space works and administering the financial contribution by Camden's open space team.

**Figure 9. Capital cost of provision**

Type of public open space	Capital cost
Amenity open space	£46.22 per sq m
Children's play space and young people's recreation space	£199.48 per sq m
Natural and semi-natural greenspace	£16.42 per sq m
Allotments/Community Gardens	£32.50 per sq m

Source: Camden Open Space, Sport and Recreation Study Update 2008

Figure 5 sets out the break down of open space requirements for developments of specific sizes. The capital costs have been aggregated in accordance with Figure 5 as set out in Figure 10.



**Figure 10. Calculation of financial contribution to capital cost**

Capital cost per square metre	Amenity open space £46.22 psm	Children's play space £199.48 psm	Natural green space £16.42 psm	Total (amenity space + play space + green space)
<b>Self-contained homes in Use Class C3</b>				
One bedroom home: space required	6.5 sq m		5.2 sq m	
Space required x cost per square metre	£300		£85	£385
Two bedroom home: space required	9.2 sq m	0.6 sq m	7.2 sq m	
Space required x cost per square metre	£425	£120	£118	£663
Three bedroom home: space required	12.8 sq m	2.9 sq m	9.5 sq m	
Space required x cost per square metre	£592	£578	£156	£1,326
Four bedroom home: space required	14.1 sq m	3.6 sq m	10.2 sq m	
Space required x cost per square metre	£652	£718	£167	£1,537
<b>Student housing, hotels and hostels</b>				
Single room: space required	5 sq m		4 sq m	
Space required x cost per square metre	£231		£66	£297
Double room: space required	10 sq m		8 sq m	
Space required x cost per square metre	£462		£131	£593
<b>Commercial/ higher education development</b>				
Space required per 1,000 sq m	21.0 sq m		17.9 sq m	
Space required x cost per square metre	£971		£294	£1,265

### Contributions to maintenance costs

In addition to capital costs, the Council has established a maintenance cost of £6.60 per square metre per year, based on the 2006 Parks and Open Spaces Budget, plus inflation.

The standard length of time developers should provide for maintenance of new and enhanced public open space is 5 years.

Commuted sums for maintenance of public open space are calculated as follows: open space requirement (sq m) x £6.60 x 5. This equates to £33 per square metre of open space required.

### Contributions to the cost of design and administration

Design and administration costs have been assessed as 12% of the capital cost of the open space provision or contribution.

## Appendix D

### Worked Examples

#### Worked Example 1:

#### Public open space provision for self-contained homes (C3)

A residential development of 16 new homes provides the following mix of dwelling sizes: 3 x 1-bedroom, 8 x 2-bedroom, 4 x 3-bedroom and 1 x 4-bedroom. The open space requirement can be calculated as follows:

Home size	No of homes	x open space requirement per home (sq m) from Figure 5	= total requirement (sq m)
One bedroom home	3	11.7	35.1
Two bedroom home	8	17.0	136.0
Three bedroom home	4	25.2	100.8
Four bedroom home	1	27.9	27.9
Total for all homes	16		299.8

The total open space requirement for this 16 home scheme would be approximately 300 sq m.

#### Worked Example 2:

#### Public open space provision for non-residential development

An office development provides 1,500sq m of additional floorspace. The open space requirement can be calculated as follows:

Additional floorspace	÷ 1,000 to give floorspace in thousands of sq m	x open space requirement per 1,000 sq m from Figure 5	= total requirement (sq m)
1,500 sq m	1.5	38.9	58.35

The total open space requirement for this additional non-residential floorspace would be approximately 60 sq m.

#### Worked Example 3:

#### Payment in lieu of open space provision for non-residential development – capital costs

As per example 2, an office development provides 1,500 sq m of additional floorspace. The payment in lieu of open space provision can be calculated as follows:

<b>Additional floorspace</b>	<b>÷ 1,000 to give floorspace in thousands of sq m</b>	<b>x capital cost per 1,000 sq m from Figure 6</b>	<b>= total payment for capital costs</b>
1,500 sq m	1.5	£1,265	£1,897.50

The payment in lieu of open space provision for this additional non-residential floorspace based on capital costs would be £1,897.50. However, we would also expect payments towards maintenance and design and administration – see example 5.

#### **Worked Example 4**

##### **Payment in lieu of open space provision for student housing – capital costs**

A student housing scheme provides 30 single rooms and 10 double rooms. The payment in lieu of open space provision can be calculated as follows:

<b>Bedroom type</b>	<b>No of bedrooms</b>	<b>x capital cost per bedroom from Figure 6</b>	<b>= total payment for capital costs</b>
Single	30	£297	£8,910
Double	10	£593	£5,930
Total for all bedrooms	40		£14,840

The payment in lieu of open space provision for this student housing based on capital costs would be £14,840. However, we would also expect payments towards maintenance and design and administration – see example 5.

#### **Worked Example 5**

##### **Payment in lieu of open space provision for self-contained homes (C3) – all costs**

A residential development of 5 new homes provides the following mix of dwelling sizes: 1 x 1-bedroom, 3 x 2-bedroom, 1 x 3-bedrooms. The total payment in lieu of open space provision can be calculated in 4 stages

**Stage 1 – Capital costs**

Home size	No of homes	x capital cost per home from Figure 6	= total payment for capital costs
One bedroom home	1	£385	£385
Two bedroom home	3	£663	£1,989
Three bedroom home	1	£1,326	£1,326
Total for all homes	5		£3,700

The payment in lieu of open space provision for this 5 home scheme based on capital costs would be £3,700.

**Stage 2 – Maintenance costs**

Home size	No of homes	x maintenance cost per unit from Figure 6	= total payment for maintenance
One bedroom home	1	£386	£386
Two bedroom home	3	£561	£1,683
Three bedroom home	1	£832	£832
Total for all homes	5		£2,901

The payment in lieu to cover maintenance of new or enhanced open space for this 5 home scheme would be £2,901.

**Stage 3 – Design and administration costs**

Home size	No of homes	x design and administration cost per unit from Figure 6	= total payment for design and administration
One bedroom home	1	£46	£46
Two bedroom home	3	£80	£240
Three bedroom home	1	£159	£159
Total for all homes	5		£445

The payment in lieu to design and administration for new or enhanced open space for this 5 home scheme would be £445.

**Stage 4 – Sum of all costs**

The three separate types of costs will not usually be aggregated for the Council's purposes (see paragraph 11.39). However, for the guidance of developers, the three costs can be added together.

In this example, the total cost to the developer would be:

Capital costs	£3,700
+ maintenance costs	£2,901
+ design and administration costs	£445
<b>= grand total</b>	<b>£7,046</b>

## 12 Planning for healthy communities

### KEY MESSAGES:

- Planning has a significant role in improving health;
- Applicants should consider the impact of the development on health;
- Applicants should submit a completed health checklist with applications.

- 12.1 It is widely recognised that the health and well-being of individuals is directly influenced by a number of related factors. These include:
- housing;
  - employment;
  - education;
  - access to green and open spaces;
  - social capital and community cohesion;
  - climate change and sustainability;
  - community safety;
  - building and urban design;
  - air and noise pollution;
  - diet and food;
  - waste; and
  - other factors.
- 12.2 Planning and the built environment have a significant role in influencing, both directly and indirectly, all of these health determinants.
- 12.3 In the UK, the 2010 Marmot review, Fair Society and Healthy Lives, also identified a number of recommendations to help deliver one of its objectives to: create and develop healthy and sustainable places and communities. These include:
- active travel;
  - provision of good quality open and green spaces;
  - improving the food environment;
  - energy efficiency of housing; and
  - to fully integrate planning, transport, housing, environmental and health systems to address the social determinants of health.



- 12.4 Camden's Core Strategy reflects health across the strategy as a cross-cutting theme and so almost all the policies in the Core Strategy will have an impact on health. For example, the following policies all have an influence on health and well-being:
- CS6 - *Providing quality homes;*
  - CS15 - *Protecting and improving our parks and open spaces and encouraging diversity;* and
  - CS11 - *Promoting sustainable and efficient travel.*
- 12.5 Policy CS16 - *Improving health and well-being* brings these policies together to ensure they are all working to tackle health inequalities and improve well-being. CS16 also sets out how we will work with NHS Camden to improve and protect health and also support the provision of new health facilities.
- 12.6 The following Core Strategy policies are also relevant as they work together to promote health and improve well-being:
- CS8 - *Promoting a successful and inclusive Camden economy,*
  - CS10 - *Supporting community facilities and services,* and
  - CS17 - *Making Camden a safer place.*
- 12.7 The following policies of the Camden Development Policies are also relevant:
- DP15 - *Community and leisure uses;*
  - DP26 - *Managing the impact of development on occupiers and neighbours;* and
  - DP32 - *Air quality and Camden's Clear Zone.*

### **Creating healthy communities**

- 12.8 Where possible developments should:
- Encourage walking and cycling;
  - Discourage car use to reduce emissions and accidents;

- Provide landscaping, planting and trees to improve air quality and quality of life;
- Provide adequate amenity space for visual and physical recreation;
- Ensure a mix of uses within or near the residential area to reduce the need to travel; and
- Improve the environmental quality of buildings to ensure buildings stay warm in winter and cool in summer.

### **The NHS Camden Health Checklist for Planning**

- 12.9 This guidance is designed to complement policy 3.2 of the London Plan which requires Health Impact Assessments for major developments, and consideration of the health impacts of development to ensure major new development promotes public health within our borough.
- 12.10 The NHS Camden health checklist for planning has been developed to ensure that health is a key consideration within new developments. The checklist provides support and guidance for developers in order to maximise the health benefits of any scheme. The NHS Camden Health Checklist for Planning is contained in Appendix 1 of this section.
- 12.11 We will require a completed health checklist to be supplied alongside all applications for all developments which meet the following criteria:
- More than 10 residential units, including changes use and new dwellings
  - More than 1,000sq m of non-residential floor space
  - Loss/gain of D1 floorspace of more than 50sq m

### **Hot food takeaways (A5 uses)**

- 12.12 The document *Healthy Weight, Healthy Lives: A Cross Government Strategy for England*, published by the government in January 2008 highlights the commitment to promoting healthier communities. A key element of this strategy is the promotion of healthier food choices. The document highlights the need for local authorities to manage the proliferation of fast food outlets as a means of combating their known adverse impact on community health.
- 12.13 Core Strategy policy CS7 and policy DP12 of the Camden Development Policies, along with Camden Planning Guidance 5 - Town Centres, Retail and Employment aim to manage the number and concentration of food, drink and entertainment uses, including hot food takeaways. The measures we use include:
- limiting the number of A5 units in centres and rows of shops (frontages);
  - preventing consecutive takeaway shops opening next to one another;
  - only allowing new A5 uses in appropriate locations where their impact can be minimised; and



- using legal obligations to ensure that impacts are controlled e.g. opening hours.

12.14 Please see section 5 on town centres, retail and entertainment uses in Camden Planning Guidance 5.

### **Assessing the requirement for new health facilities**

12.15 Health facilities include hospital and other premises that provide health and medical services such as doctors, integrated care centres, polyclinics and dentists. Camden Core Strategy policy CS10 aims to ensure that sufficient community facilities (including health facilities) are provided to meet the needs of Camden's population. Policy CS16 specifically aims to ensure that there is adequate provision of health facilities in partnership with NHS Camden.

12.16 Part e) of CS10 expects development that increases the demand for community facilities and services to make appropriate contributions towards providing new facilities or improving existing facilities. These contributions could be financial or they could involve the direct (re)provision of health facilities within or near a proposed development site.

12.17 The Council will consult with NHS Camden to assess the appropriate level and type of contribution required to mitigate any health care impacts which might be generated by a development proposal. The Council will also have regard to the model commissioned by the Healthy Urban Development Unit (HUDU), updated October 2009. The model is designed to forecast the level of demand for health facilities that might result from a new development and the subsequent cost of provision. Large, strategic schemes will be expected to assess the impact of visitors and employees in addition to the new and existing resident population. In other cases, contributions will not normally be sought for developments of less than 10 residential units.

12.18 Please see Camden Planning Guidance 8 – *Planning obligations* for our detailed approach.

### Further information

PPS1	PPS1 - Delivering Sustainable Development indicates that LDF policies should plan to protect human health and address accessibility for all members of the community to a range of facilities including health, leisure and community services. It also states that LDF documents should deliver safe, healthy and attractive places to live and support the promotion of health and wellbeing by making provision for physical activity.
PPS23	PPS 23 - Planning and Pollution Control states that potential health impacts arising from development can be a material consideration.
The London Plan	The London Plan (consolidated since 2004) published in 2008 recognises health as a key cross-cutting objective of the overall strategy. The Plan also contains the following relevant policies: <ul style="list-style-type: none"> <li>• Policy 3A.20 Locations for health care</li> <li>• Policy 3A.21 Health objectives</li> <li>• Policy 3A.22 Medical excellence</li> </ul>
Mayor's Guidance	<ul style="list-style-type: none"> <li>• Health Issues in Planning: Best Practice Guidance (June 2007) – explains how planning decisions can directly and indirectly improve health and reduce health inequalities through a number of topics, e.g. housing, transport, employment and skills, education etc.</li> <li>• Sustainable design and Construction (May 2006) – recommends a number of building specific measures to benefit the health of occupants, e.g. improving internal air quality, ensuring sufficient levels of natural light etc.</li> </ul>
CABE	Commission for Architecture and the Built Environment. (2009). Future health: sustainable places for health and wellbeing.
Key determinants of health	Search on the London Health Observatory: <a href="http://www.lho.org.uk">www.lho.org.uk</a>
Healthy Urban Development Unit	Guidance on linking planning and health: <a href="http://www.healthyurbandevlopment.nhs.uk/pages/key_docs/key_documents_hudu.html">www.healthyurbandevlopment.nhs.uk/pages/key_docs/key_documents_hudu.html</a>

## Appendix 1: NHS Camden health checklist for planning

Issue to address	Included in proposal/development	Provide details (Evidence from proposals)	Further action required	Relevant LDF policies
<b>1.0 HEALTHCARE FACILITIES AND SERVICES</b>				
<b>1.1</b> Will the development increase demand on existing primary and secondary care health services?	<input type="checkbox"/> Yes <input type="checkbox"/> No (if no, please indicate what further action will be required)			Core strategy policy CS16
<b>2.0 PHYSICAL ACTIVITY</b>				
<b>2.1</b> Do the proposals maximise physical activity opportunities? (Active travel; leisure facilities; access to green and open spaces; HomeZones; schools; business; Olympics etc)	<input type="checkbox"/> Yes <input type="checkbox"/> No (if no, please indicate what further action will be required)			Core Strategy policies, CS11, CS15, CS16 and Development Policies DP15, DP17, DP31
<b>3.0 CRIME AND COMMUNITY SAFETY</b>				
<b>3.1</b> Have measures been taken to ensure that the proposals will not have a negative impact on crime and community safety? (Licensed premises; drugs & alcohol; road traffic injuries; etc.)	<input type="checkbox"/> Yes <input type="checkbox"/> No (if no, please indicate what further action will be required)			Core Strategy policy CS17
<b>4.0 HOUSING</b>				
<b>4.1</b> Do the proposals include housing which is: affordable, in mixed use developments; mixed tenure (private, affordable, social); different sizes, accessible and suitable for all ages.	<input type="checkbox"/> Yes <input type="checkbox"/> No (if no, please indicate what further action will be required)			Core Strategy policy CS6 and Development Policies DP1-9
<b>5.0 EMPLOYMENT AND TRAINING</b>				
<b>5.1</b> Do the proposals provide employment and training opportunities for local people?	<input type="checkbox"/> Yes <input type="checkbox"/> No (if no, please indicate what further action will be required)			Core Strategy policy CS8 and Development Policy DP13
<b>6.0 EDUCATION</b>				
<b>6.1</b> If education facilities are provided, will they be designed to include wider community use and include green and open space?	<input type="checkbox"/> Yes <input type="checkbox"/> No (if no, please indicate what further action will be required)			Core Strategy policy CS10
<b>7.0 NEIGHBOURHOOD AND BUILDING DESIGN</b>				
<b>7.1</b> Do the proposals include: accessible street designs for older people and people with mobility problems; and gardens allotments or play areas?	<input type="checkbox"/> Yes <input type="checkbox"/> No (if no, please indicate what further action will be required)			Core Strategy policies CS14 and CS15
<b>7.2</b> Do proposals ensure that buildings are designed to maximise physical activity (positioning of stairwells, shower rooms, secure cycle parking etc)	<input type="checkbox"/> Yes <input type="checkbox"/> No (if no, please indicate what further action will be required)			Core Strategy policies CS11, CS16 and Development Policies DP6, DP17, DP24
<b>8.0 CLIMATE CHANGE AND SUSTAINABILITY</b>				
<b>8.1</b> Do the proposals mitigate against a negative impact on the environment (noise & air quality; renewable energy; contaminated land; waste management etc.)	<input type="checkbox"/> Yes <input type="checkbox"/> No (if no, please indicate what further action will be required)			Core Strategy Policy CS13 and Development Policy DP22
<b>9.0 FOOD</b>				
<b>9.1</b> Do the proposals include provision of affordable and nutritious food outlets, food growing and limit the proliferation of fast-food outlets?	<input type="checkbox"/> Yes <input type="checkbox"/> No (if no, please indicate what further action will be required)			CS16
<b>10.0 WIDER ASSESSMENT</b>				
<b>10.1</b> Have the health impacts been considered as part of any other assessment? (SEA, HIA, IIA, EIA etc)	<input type="checkbox"/> Yes <input type="checkbox"/> No (if no, please indicate what further action will be required)			n/a

**Index**

Access (disabled).....	45	Micro-climate . See Wind and micro-climate	
Air quality.....	7	Noise and vibration.....	19
Allotments.....	62	Open space .....	59
Construction management plans	39	Overlooking.....	37
Contaminated land .....	15	Play Space.....	61
Daylight and sunlight.....	31	Privacy .....	See Overlooking
Green spaces .....	62	Right to light.....	35
Healthy communities .....	79	sport and recreation facilities.....	59
Hot food takeaways.....	81	Wind and micro-climate .....	53
Lighting.....	25		

Strategic Planning and Information  
London Borough of Camden  
Town Hall Extension, Argyle Street  
London WC1H 8EQ  
Tel: 020 7974 2043 / 2519  
Fax: 020 7974 1930  
Email: [ldf@camden.gov.uk](mailto:ldf@camden.gov.uk)  
[www.camden.gov.uk](http://www.camden.gov.uk)