

DET-A Roof Perimeter Detail-1st Floor
143218 1:5

DET-B Roof Perimeter Detail-3rd Floor
143218 1:5

DET-C Roof Perimeter Detail-5th Floor
143218 1:5

NOTES:

Rev	DATE	REVISION HISTORY	Dsg	Dw	Clk	App
E	11.11.16	100% Stage E Issue	STW	BB	RM	KB
D	17/08/16	Updated to Structural Engineers' comments	STW	RM	KB	KB
C	01/08/16	Updated to Byuk Comments and Issued for 90% Review	STW	BB	MK	KB
B	18/07/16	Issued For Tender	STW	STW	BYUK	BYUK
A	06/07/16	Issued For Facade and Roof Tender	STW	STW	BYUK	BYUK

ALL REVISIONS

Rev	DATE	REVISION HISTORY	Dsg	Dw	Clk	App



BOUYGUES
Head Office:
Elizabeth House,
39 York Road,
London, SE1 7NQ,
Tel: 020 7401 0020
Fax: 020 7401 0030
www.bouygues-uk.com

University College London Hospitals NHS Foundation Trust

Name	Signature	Date
Designed by	STW	2016/11/11
Drawn by	BB	2016/11/11
Checked	RM	2016/11/11
Approved	KB	2016/11/11

ORIGINATOR
Scott Tallon Walker Architects
NG Bailey CampbellReith
VARIAN medical systems Particle Therapy

SCALE: 1:5 @ A1
BIM FILE NAME: P4PBT-STW-AFA-SL-M3-A31-100060
FIRST ISSUE DATE: 2016/07/06
PROPOSED STATUS: For Procurement

DRAWING TITLE
UCLH Phase 4 & PBT
Roof Package Details - A, B and C

PROJECT	ISSUER	AREA	LEVEL	TYPE	TRADE	SEQUENCE	REV
P4PBT	STW	AFA	SL	DET	A31	143218	E

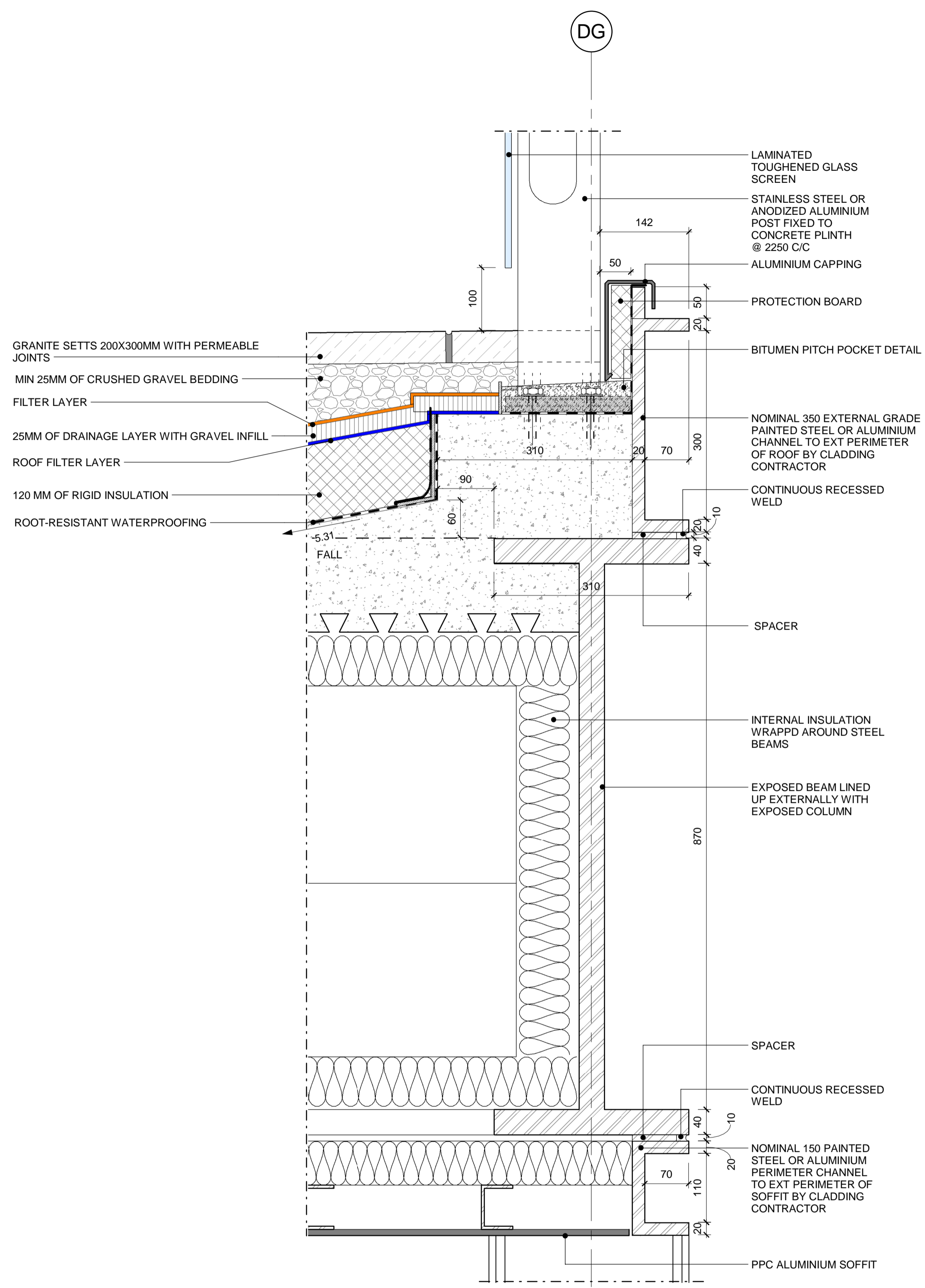
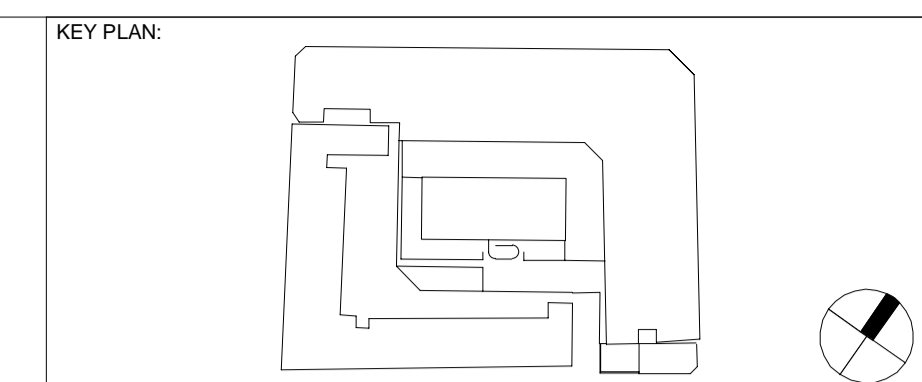

DET-D Roof Perimeter Detail-1st Floor 2
143219 1:5

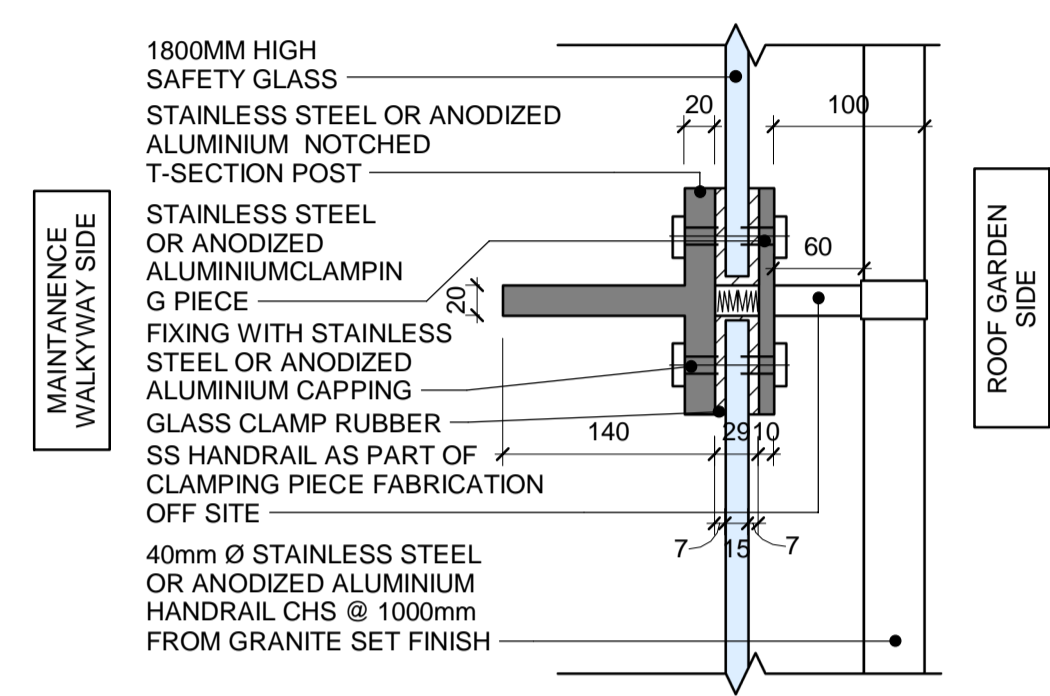

DET-E External Balustrade Post Plan Detail
143219 1:5

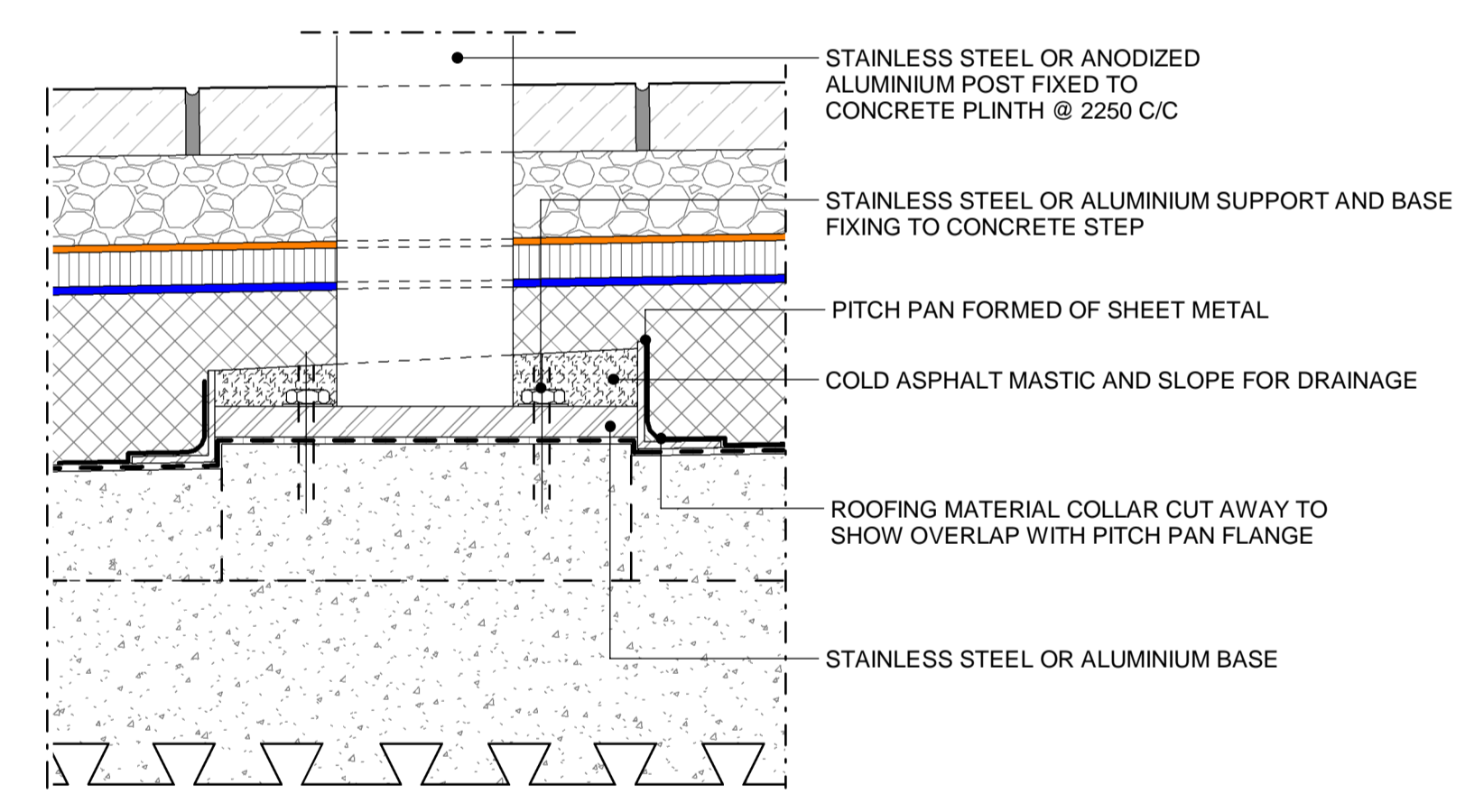

DET-F Pitch Pocket Detail
143219 1:5

NOTES:

ALL REVISIONS						
Rev	DATE	REVISION HISTORY	Dsg	Dw	Clk	App
E	11/11/16	100% Stage E Issue	STW	BB	RM	KB
D	17/08/16	Updated to Structural Engineers' comments	STW	RM	KB	KB
C	01/08/16	Updated to Byuk Comments and Issued for 90% Review	STW	BB	MK	KB
B	18/07/16	Issued For Tender	STW	STW	BYUK	BYUK
A	06/07/16	Issued For Facade and Roof Tender	STW	STW	BYUK	BYUK



BOUYGUES
Head Office:
Elizabeth House,
39 York Road,
London, SE1 7NQ,
Tel: 020 7401 0020
Fax: 020 7401 0030
www.bouygues-uk.com

University College London Hospitals NHS Foundation Trust

Name	Signature	Date
Designed by	STW	2016/11/11
Drawn by	BB	2016/11/11
Checked	RM	2016/11/11
Approved	KB	2016/11/11

ORIGINATOR
Scott Tallon Walker Architects

NG Bailey CampbellReith

VARIAN Particle Therapy

SCALE: 1:5 @ A1

BIM FILE NAME: P4PBT-STW-AFA-SL-M3-A31-100060

FIRST ISSUE DATE: 2016/07/06

PROPOSED STATUS: For Procurement

DRAWING TITLE: UCLH Phase 4 & PBT Roof Package Details - D, E and F

PROJECT	ISSUER	AREA	LEVEL	TYPE	TRADE	SEQUENCE	REV
P4PBT	STW	AFA	SL	DET	A31	143219	E

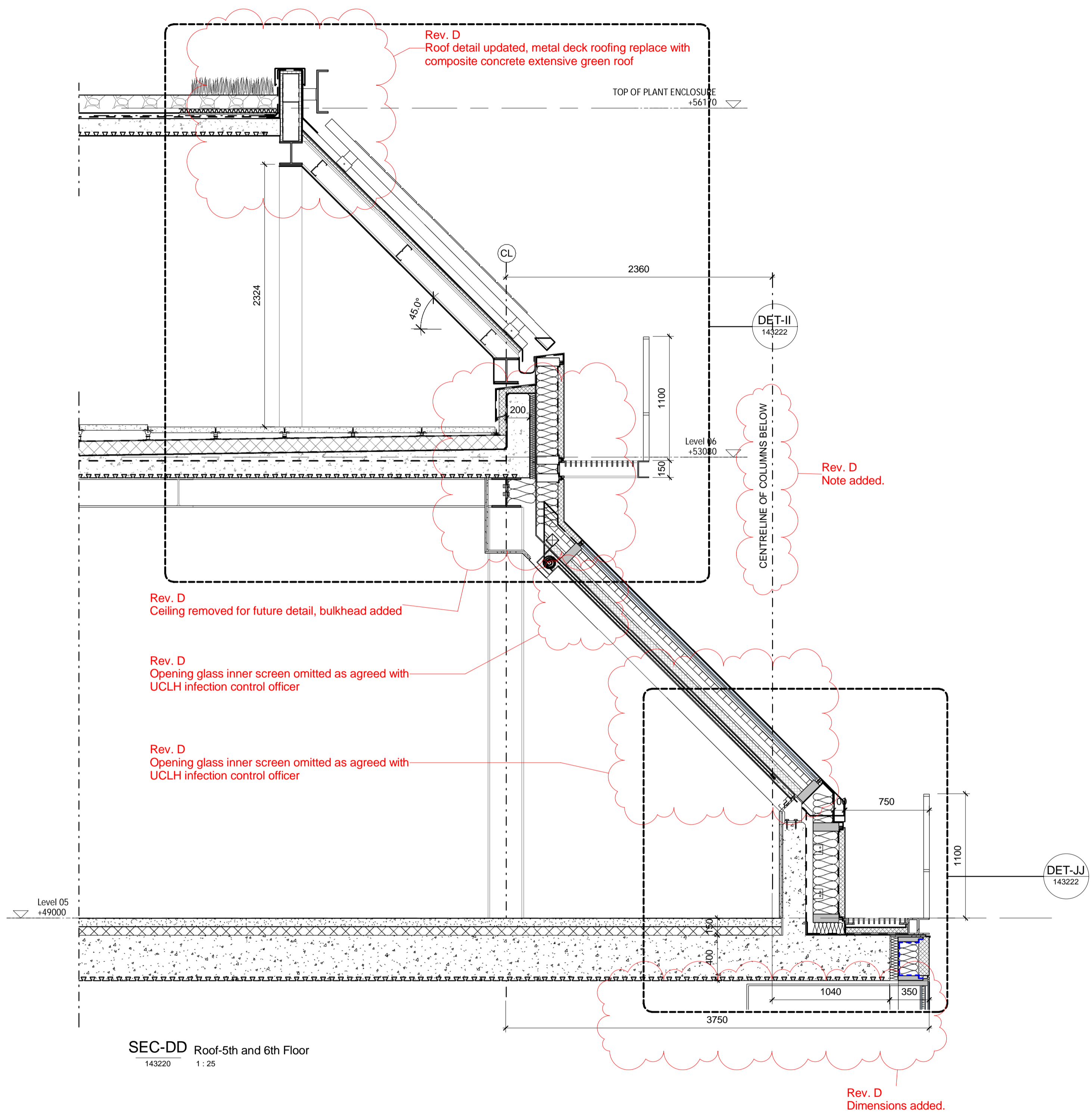
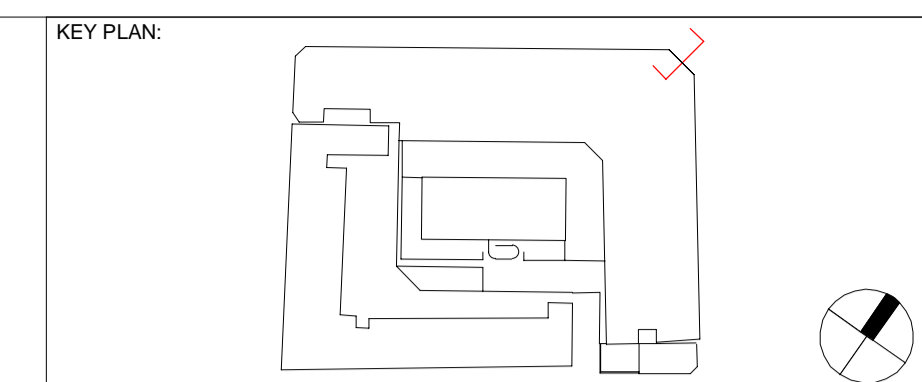

SEC-DD Roof-5th and 6th Floor
143220 1:25

NOTES:

ALL REVISIONS						
Rev	DATE	REVISION HISTORY	Dsg	Drw	Chk	App
D	11.11.16	100% Stage E issue.	STW	SL	RM	KB
C	01/08/16	Updated to Byuk Comments and Issued for 90% Review	STW	FL	MK	KB
B	18/07/16	Issued For Tender	STW	STW	BYUK	BYUK
A	06/07/16	Issued For Facade and Roof Tender	STW	STW	BYUK	BYUK



BOUYGUES
UK
Head Office:
Elizabeth House,
39 York Road,
London, SE1 7NQ,
Tel: 020 7401 0020
Fax: 020 7401 0030
www.bouygues-uk.com

University College London Hospitals **NHS**
NHS Foundation Trust

Name	Signature	Date
Designed by	STW	2016/11/11
Drawn by	SL	2016/11/11
Checked	RM	2016/11/11
Approved	KB	2016/11/11

ORIGINATOR
Scott Tallon Walker Architects

NG Bailey CampbellReith

ccrd **h**
medical systems | Particle Therapy
VARIAN

SCALE: 1:25 @ A1
BIM FILE NAME: P4PBT-STW-AFA-SL-M3-A31-100060
FIRST ISSUE DATE: 2016/07/06
PROPOSED STATUS: For Procurement

DRAWING TITLE: UCLH Phase 4 & PBT
Roof Package Section DD Through 5th and 6th Floor

PROJECT	ISSUER	AREA	LEVEL	TYPE	TRADE	SEQUENCE	REV
P4PBT	STW	AFA	SL	SEC	A31	143220	D

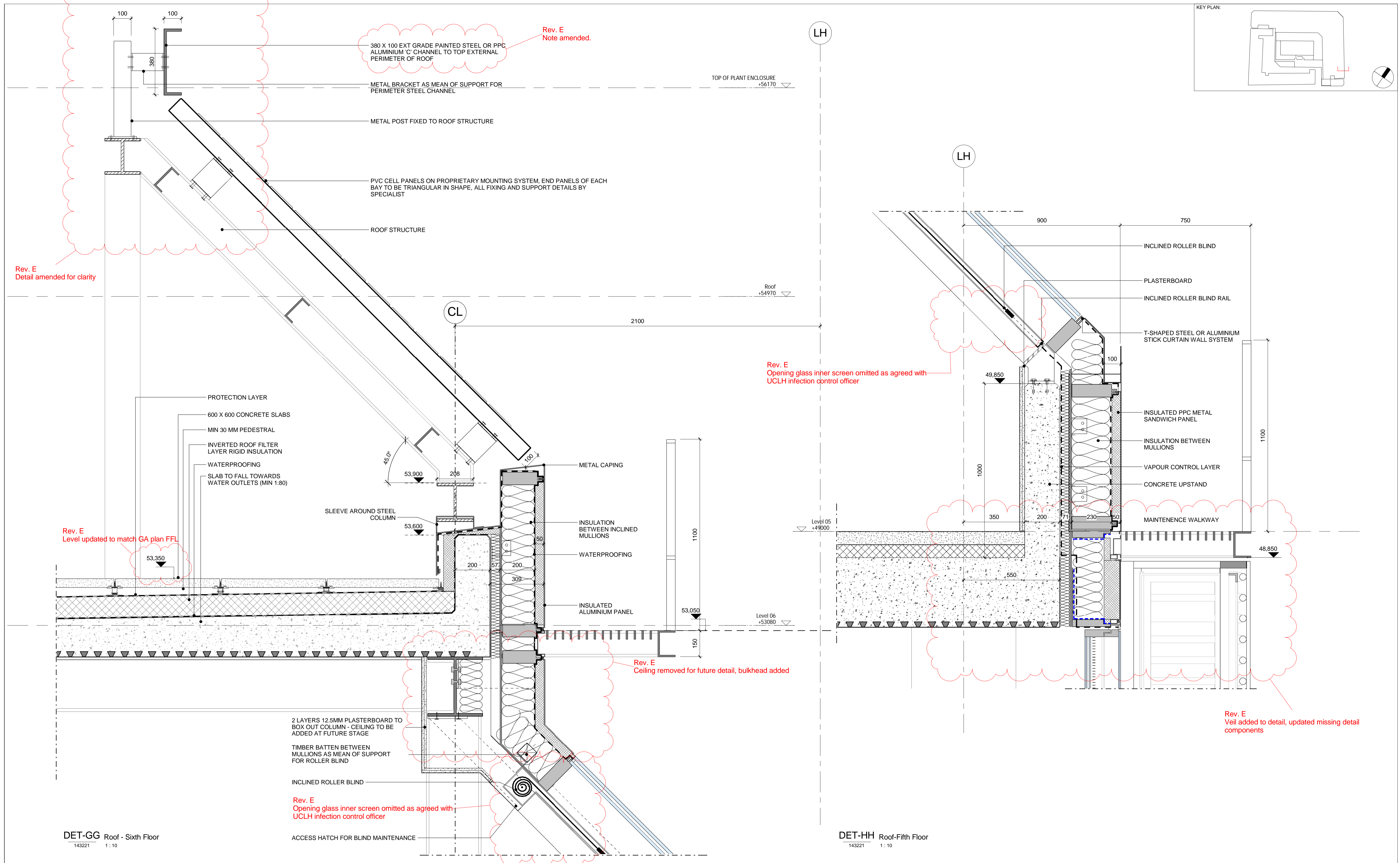

NOTES:

ALL REVISIONS

Rev	DATE	REVISION HISTORY	Dsg	Drw	Clk	App
E	11.11.16	100% Stage E Issue	STW	SL	RM	KB
D	17/08/16	Updated to Structural Engineers' comments	STW	RM	KB	KB
C	01/08/16	Updated to Byuk Comments and Issued for 90% Review	STW	CB	MK	KB
B	18/07/16	Issued For Tender	STW	STW	BYJK	BYJK
A	06/07/16	Issued For Facade and Roof Tender	STW	STW	BYJK	BYJK



BOUYGUES
 Head Office:
 Elizabeth House,
 39 York Road,
 London, SE1 7NQ,
 Tel: 020 7401 0020
 Fax: 020 7401 0030
 www.bouygues-uk.com

University College London Hospitals NHS Foundation Trust

Name	Signature	Date
Designed by	STW	11.11.16
Drawn by	SL	11.11.16
Checked	RM	11.11.16
Approved	KB	11.11.16

ORIGINATOR
 Scott Tallon Walker Architects
 NG Bailey CampbellReith
 VARIAN medical systems
 Particle Therapy

SCALE: 1:10 @ A1
 BIM FILE NAME: P4PBT-STW-AFA-SL-M3-A31-100060
 FIRST ISSUE DATE: 2016/07/06
 PROPOSED STATUS: For Procurement

DRAWING TITLE
 UCLH Phase 4 & PBT
 Roof Package Details Through 5th and 6th Floor - G and H

PROJECT	ISSUER	AREA	LEVEL	TYPE	TRADE	SEQUENCE	REV
P4PBT	STW	AFA	SL	DET	A31	143221	E

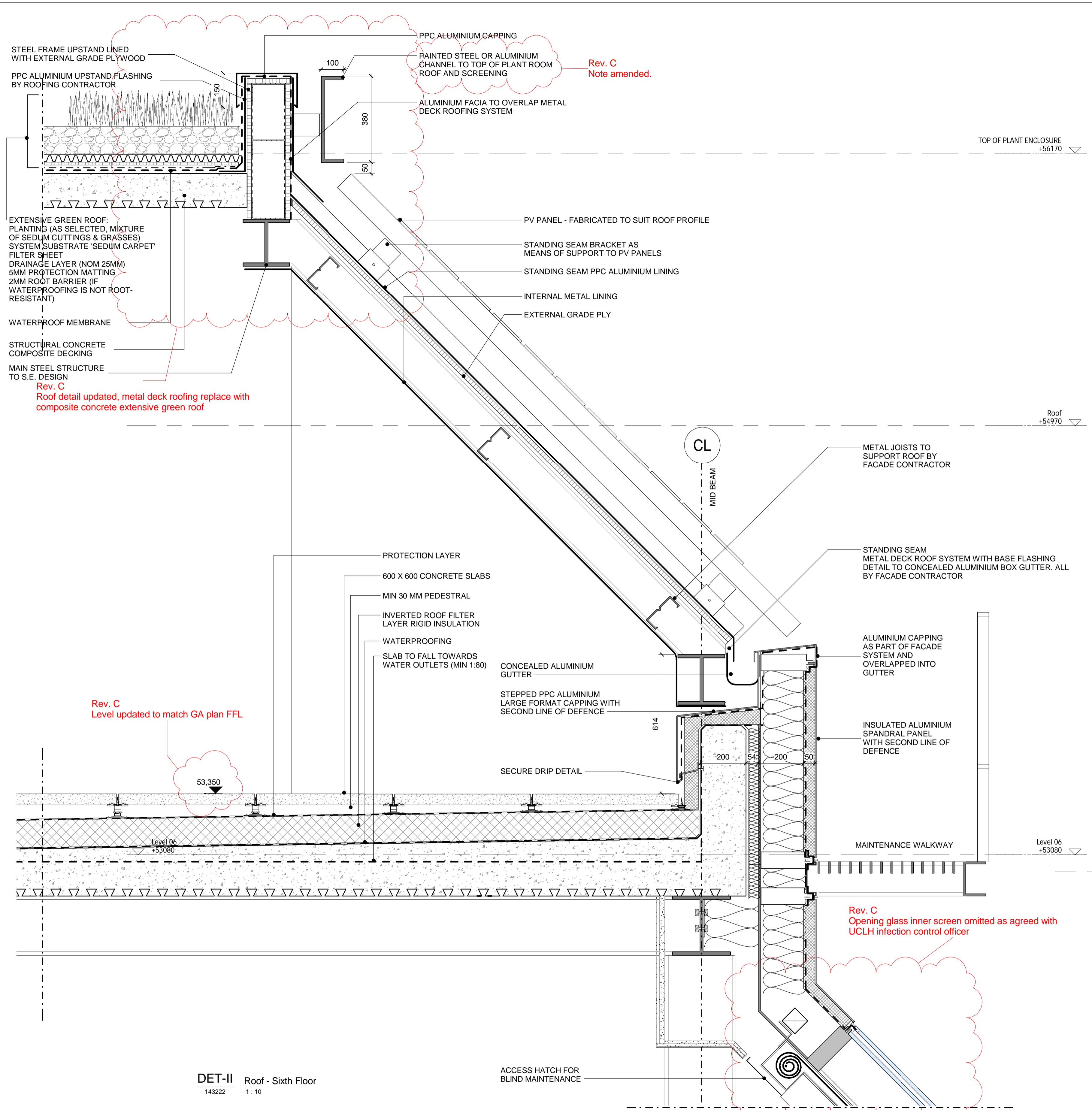

DET-II Roof - Sixth Floor
143222 1:10

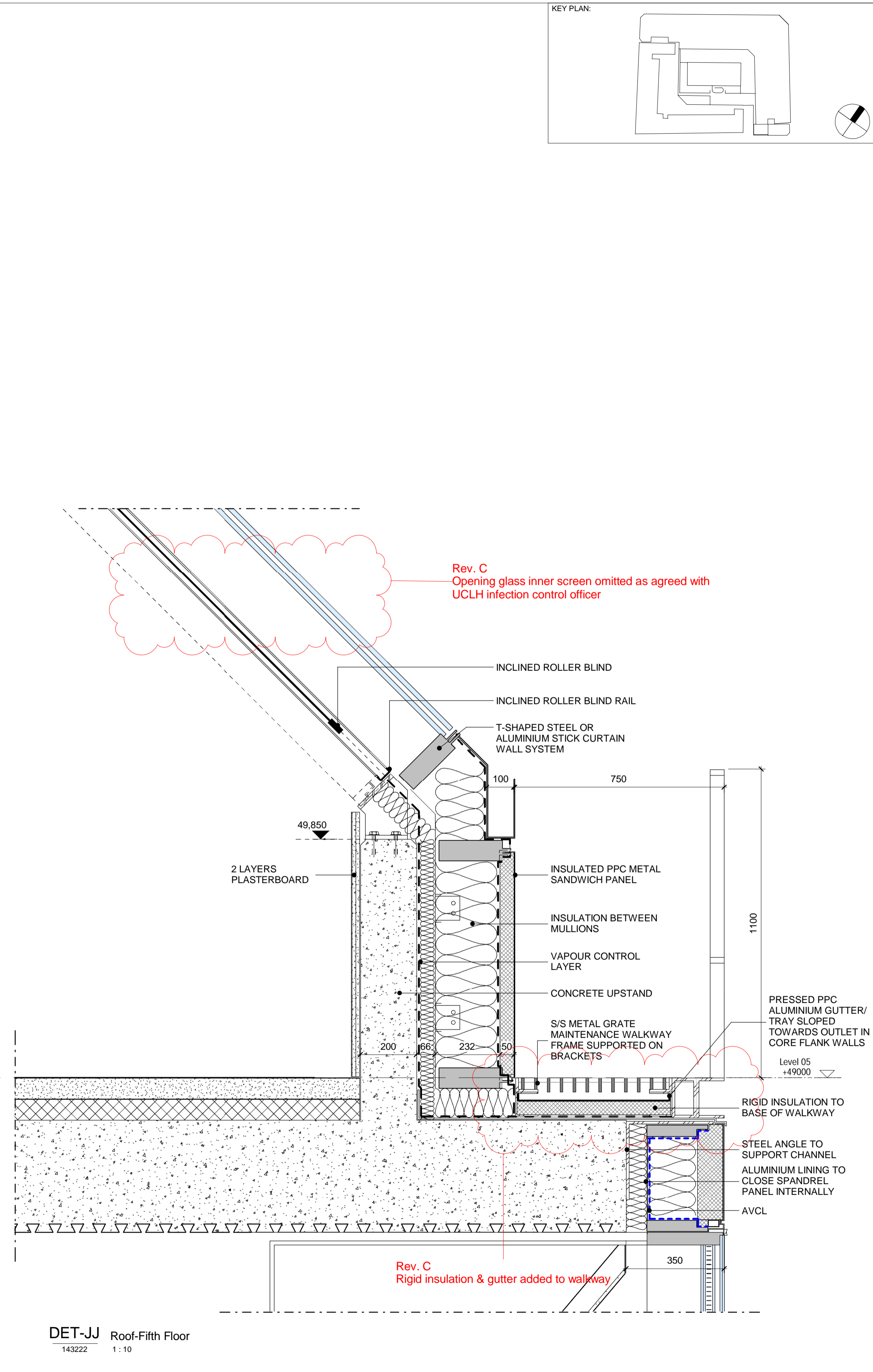

DET-JJ Roof-Fifth Floor
143222 1:10

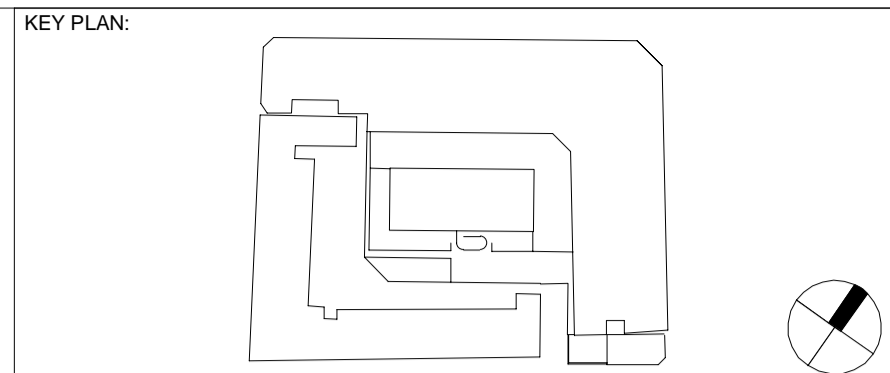

NOTES:

Rev	DATE	REVISION HISTORY	Dsg	Drw	Chk	App
C	11.11.16	100% Stage E issue.	STW	SL	RM	KB
B	17/08/16	Updated to Structural Engineers' comments	STW	RM	KB	KB
A	01/08/16	Updated to Byuk Comments and Issued for 90% Review	STW	SL	MK	KB

ALL REVISIONS

Rev	DATE	REVISION HISTORY	Dsg	Drw	Chk	App



BOUGUES
Head Office:
Elizabeth House,
39 York Road,
London, SE1 7NQ,
Tel: 020 7401 0020
Fax: 020 7401 0030
www.bougues-uk.com

University College London Hospitals NHS Foundation Trust

Name	Signature	Date
Designed by	STW	2016/11/11
Drawn by	SL	2016/11/11
Checked	RM	2016/11/11
Approved	KB	2016/11/11

ORIGINATOR: Scott Tallon Walker Architects

NG Bailey CampbellReith

VARJAN medical systems | Particle Therapy

SCALE: 1:10 @ A1

FIRST ISSUE DATE: 2016/08/01

PROPOSED STATUS: For Procurement

BIM FILE NAME: P4PBT-STW-AAG-SL-M3-A31-100060

DRAWING TITLE: UCLH Phase 4 & PBT

Roof Package Details Through 5th and 6th Floor - I and J

PROJECT	ISSUER	AREA	LEVEL	TYPE	TRADE	SEQUENCE	REV
P4PBT	STW	AFA	SL	DET	A31	143222	C