

W134: W129

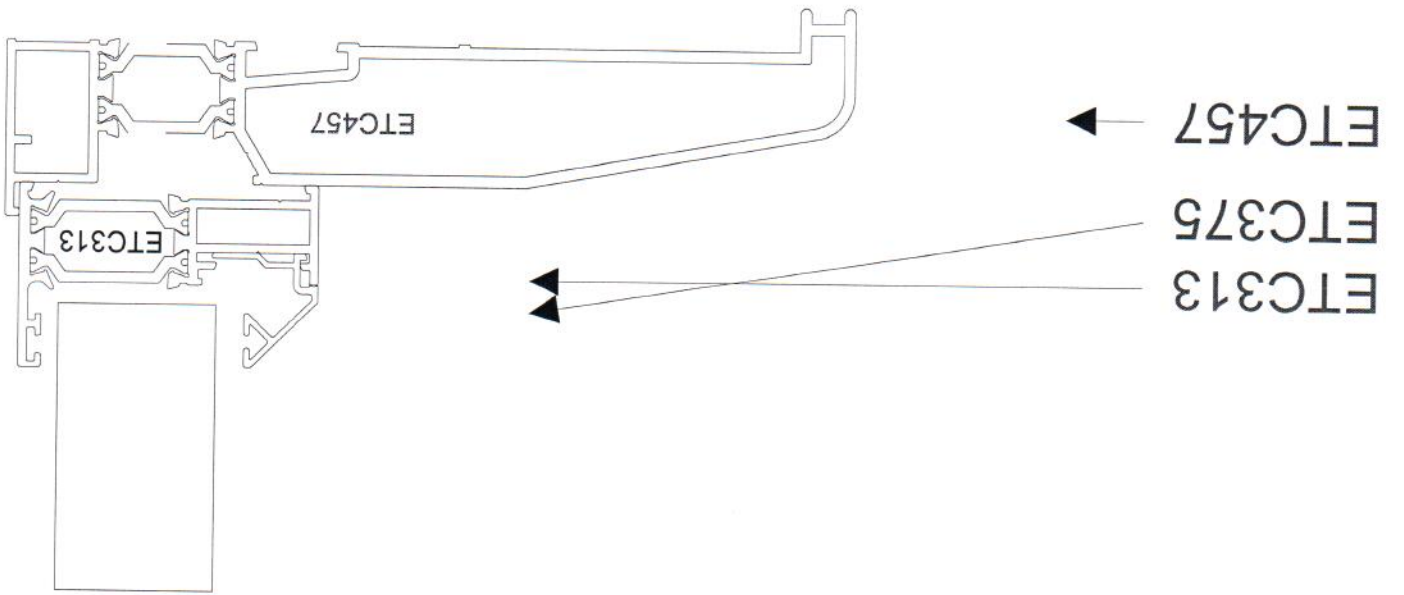

B

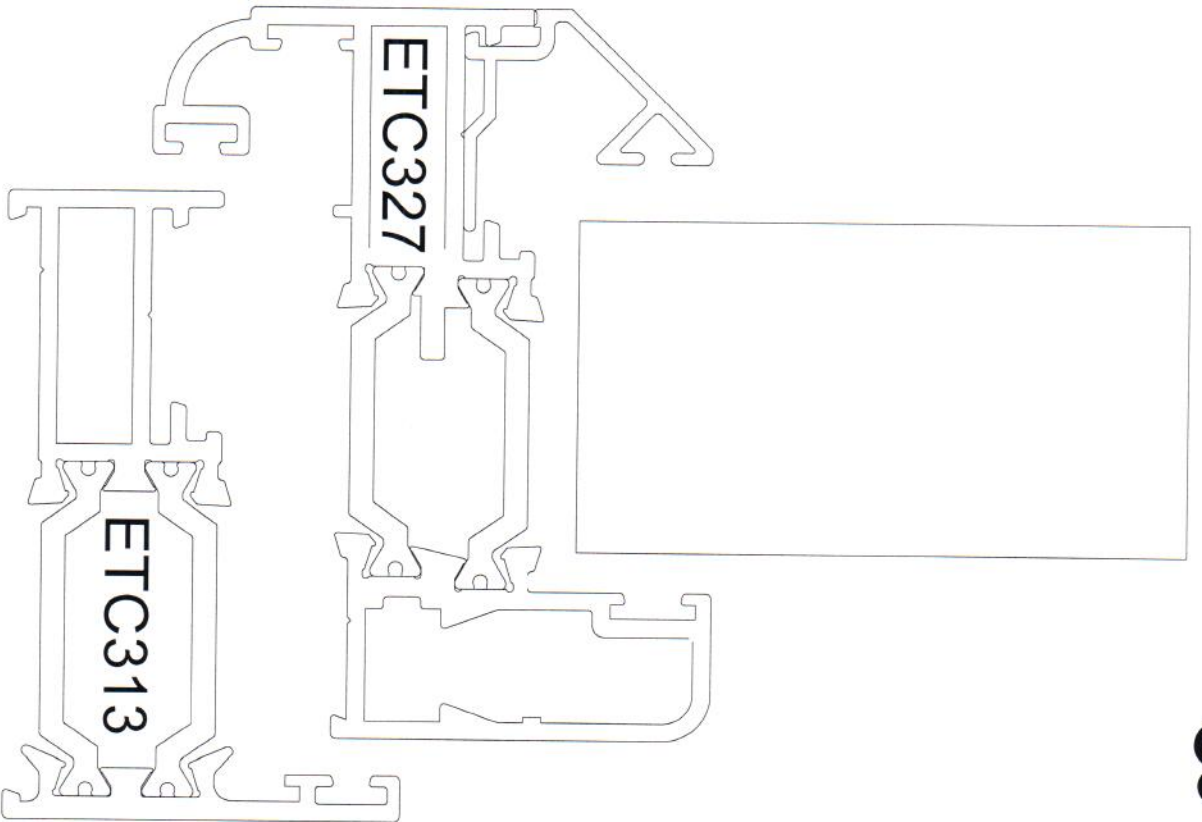

ETC375
ETC327
ETC313

Three arrows point downwards from the text labels 'ETC375', 'ETC327', and 'ETC313' to the corresponding parts in the diagram below. The arrow from 'ETC375' points to the top edge of the main assembly. The arrow from 'ETC327' points to the upper central part of the assembly. The arrow from 'ETC313' points to the lower right part of the assembly.

ETC313 ←
ETC327 ←
ETC375 ←

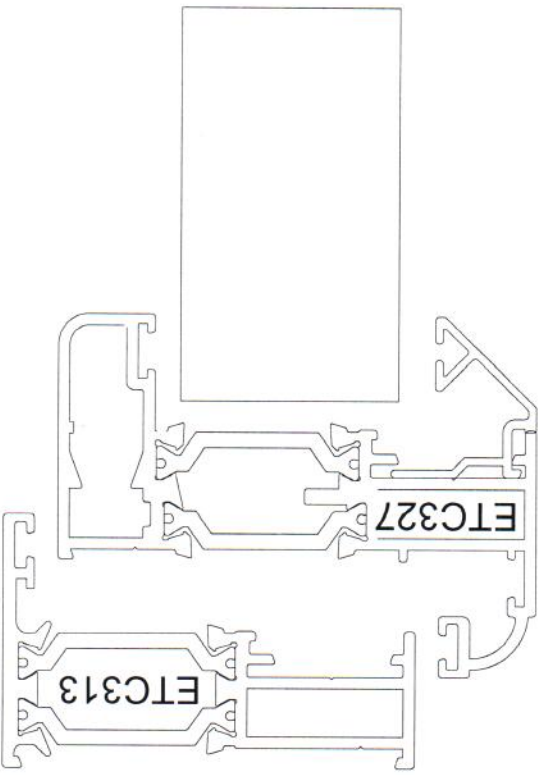

D

ETC313 ←
ETC327 ←
ETC375 ←

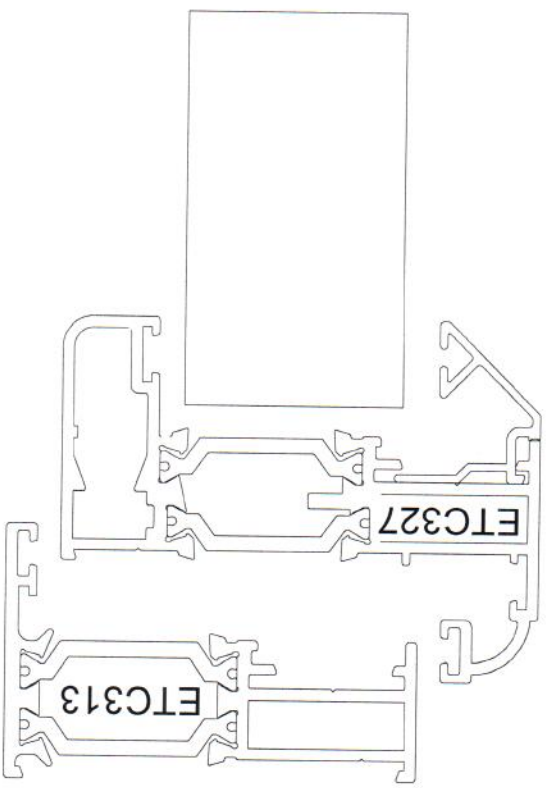

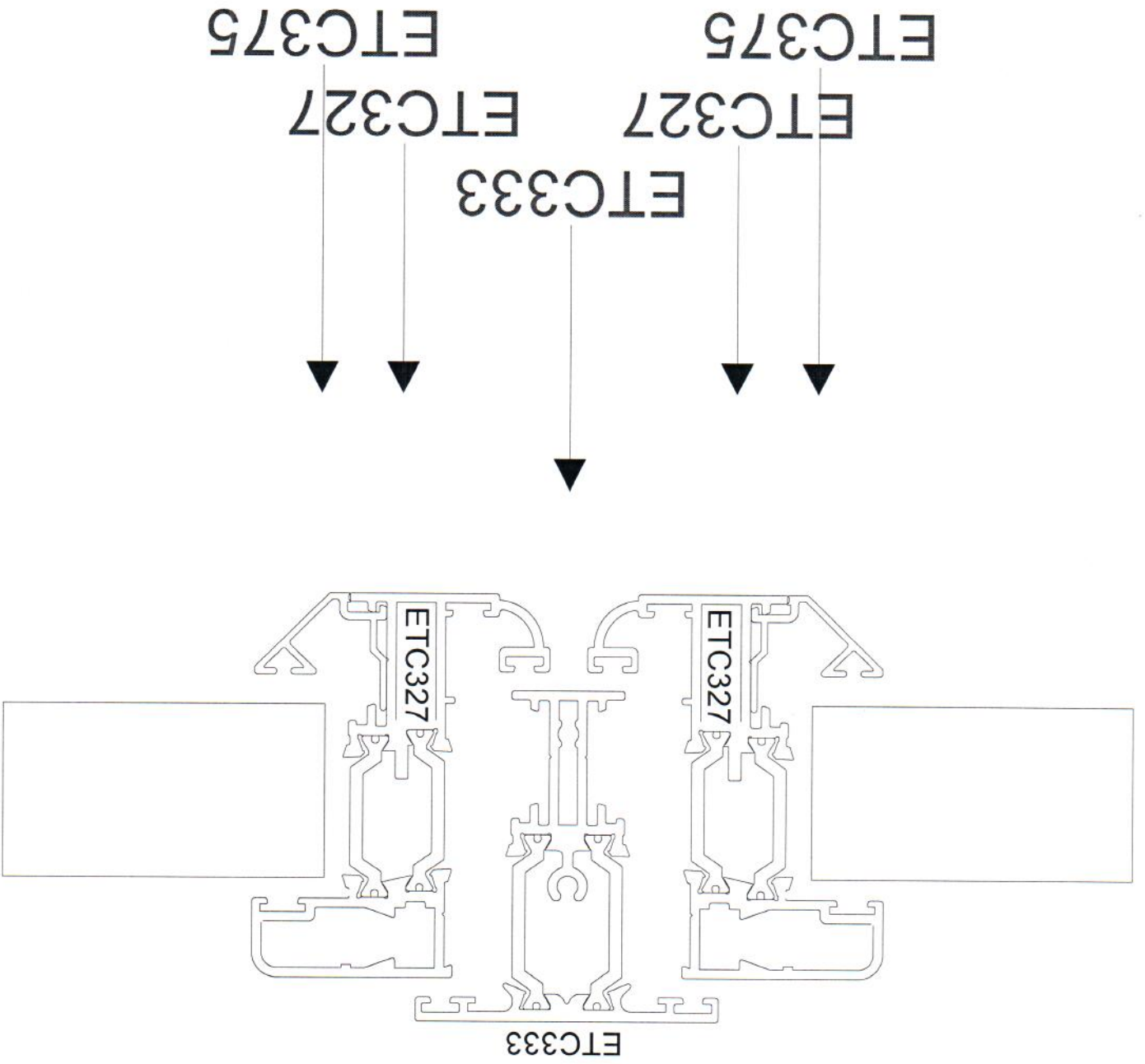

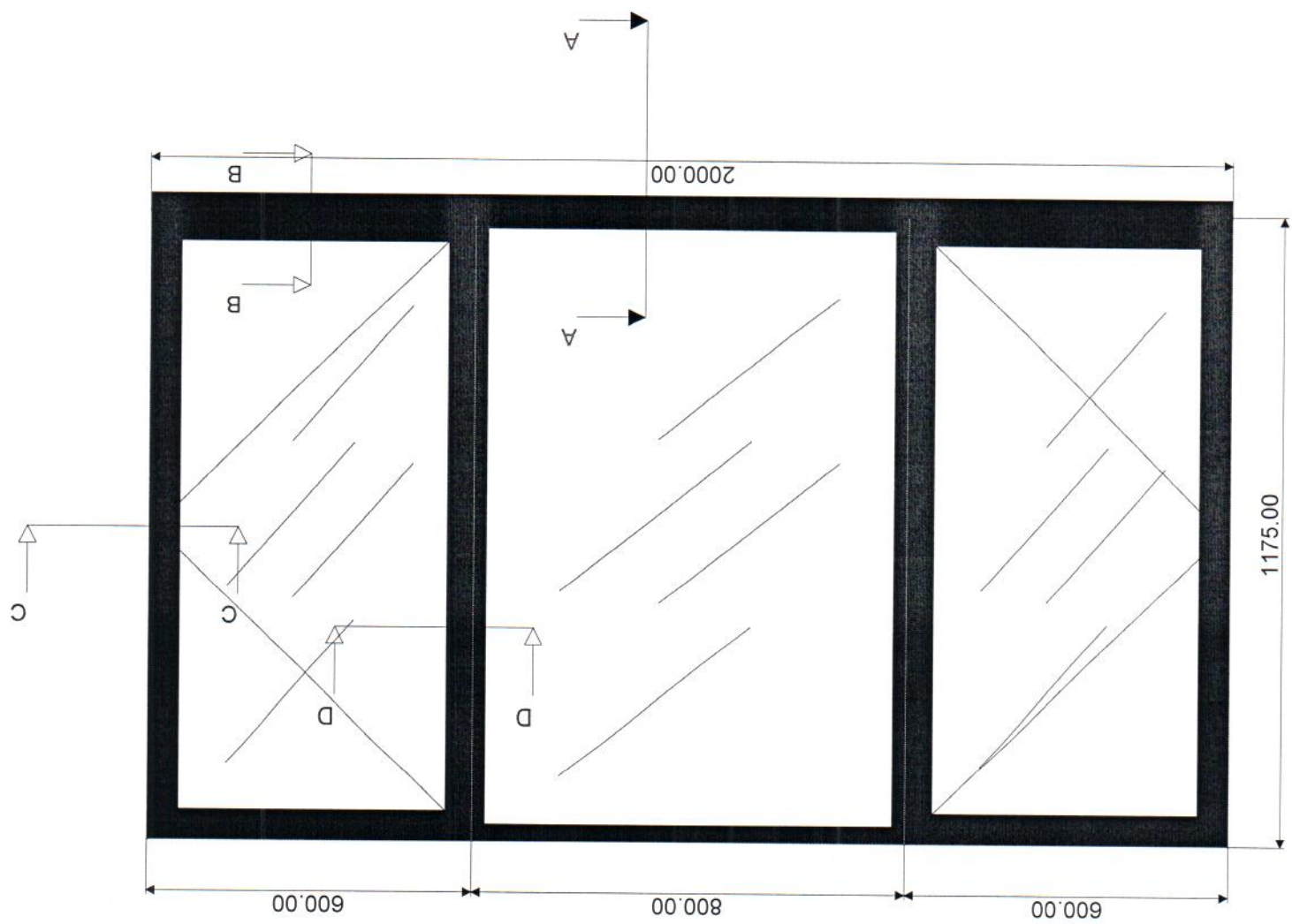

M138.

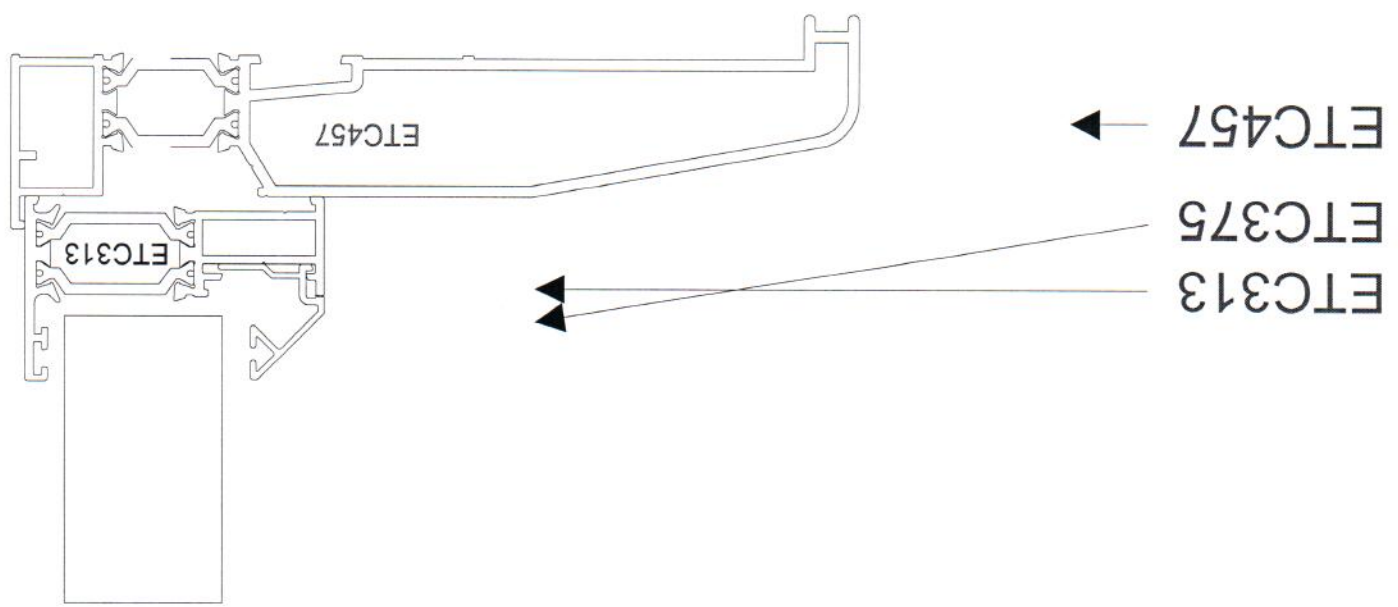

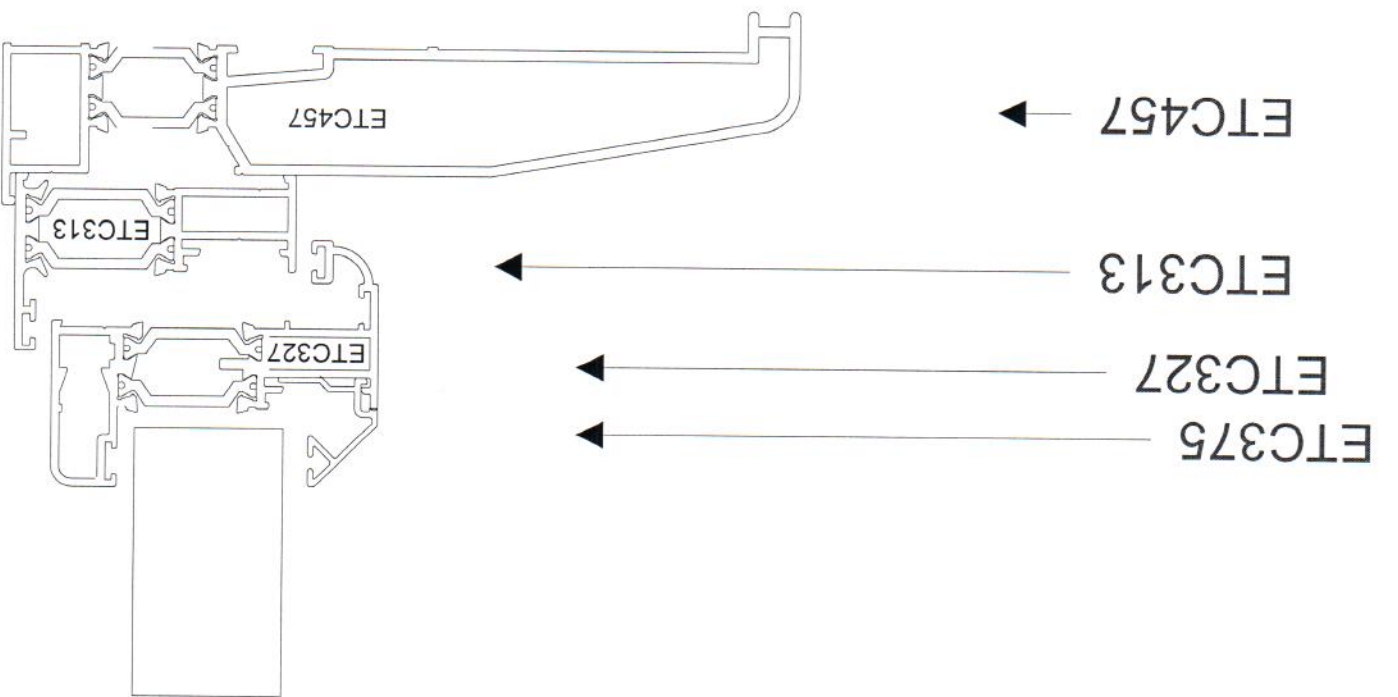

C

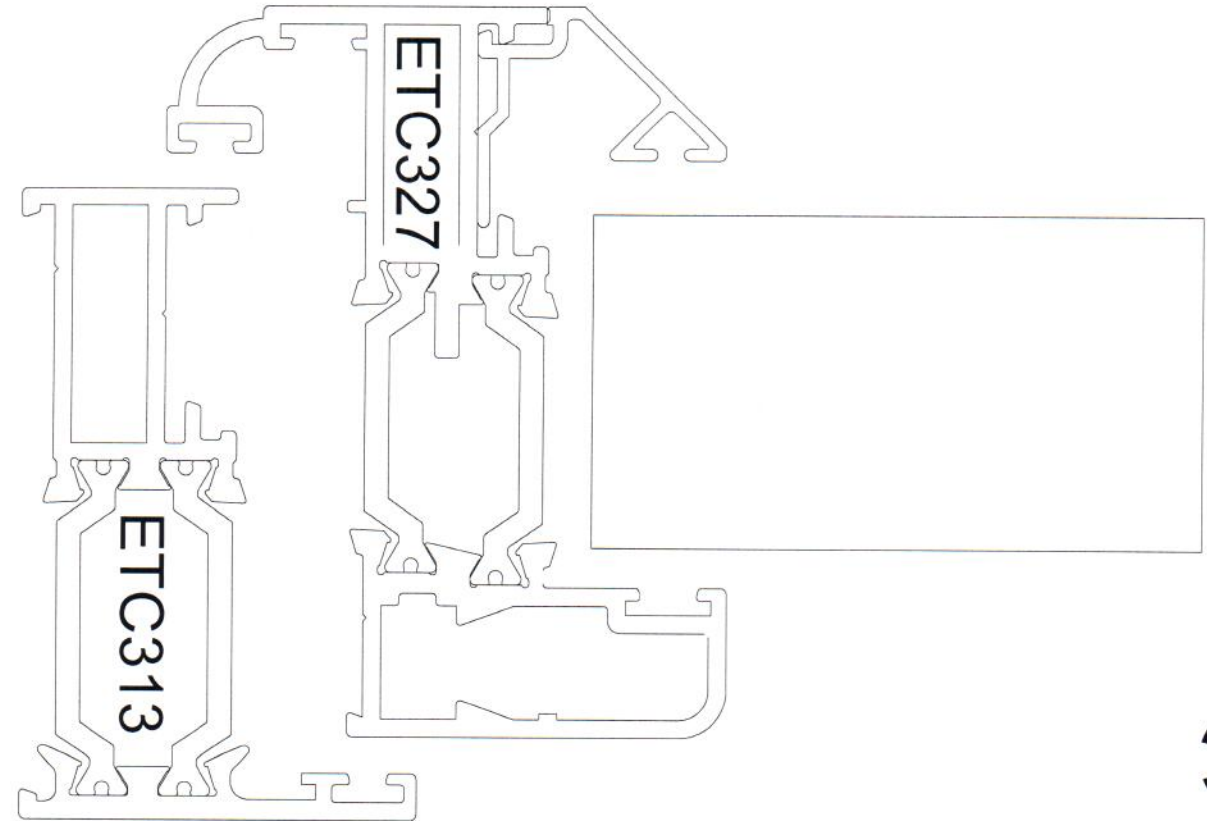

ETC375
ETC327
ETC313

Three arrows point downwards from the labels above. The top arrow points from 'ETC375' to the top of the 'ETC327' label. The middle arrow points from 'ETC327' to the top of the 'ETC313' label. The bottom arrow points from 'ETC313' to the top of the 'ETC327' label. The arrows are arranged in a staggered fashion, with the top arrow being the longest and the bottom arrow being the shortest.

D

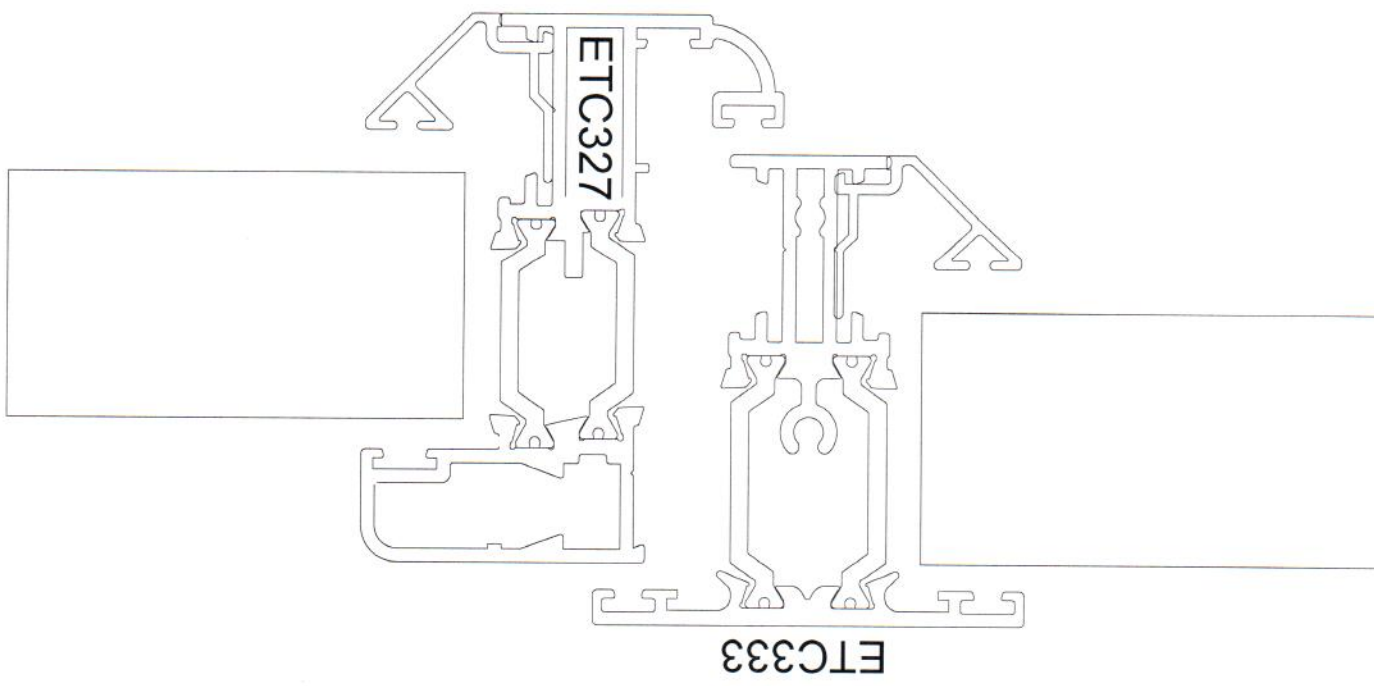

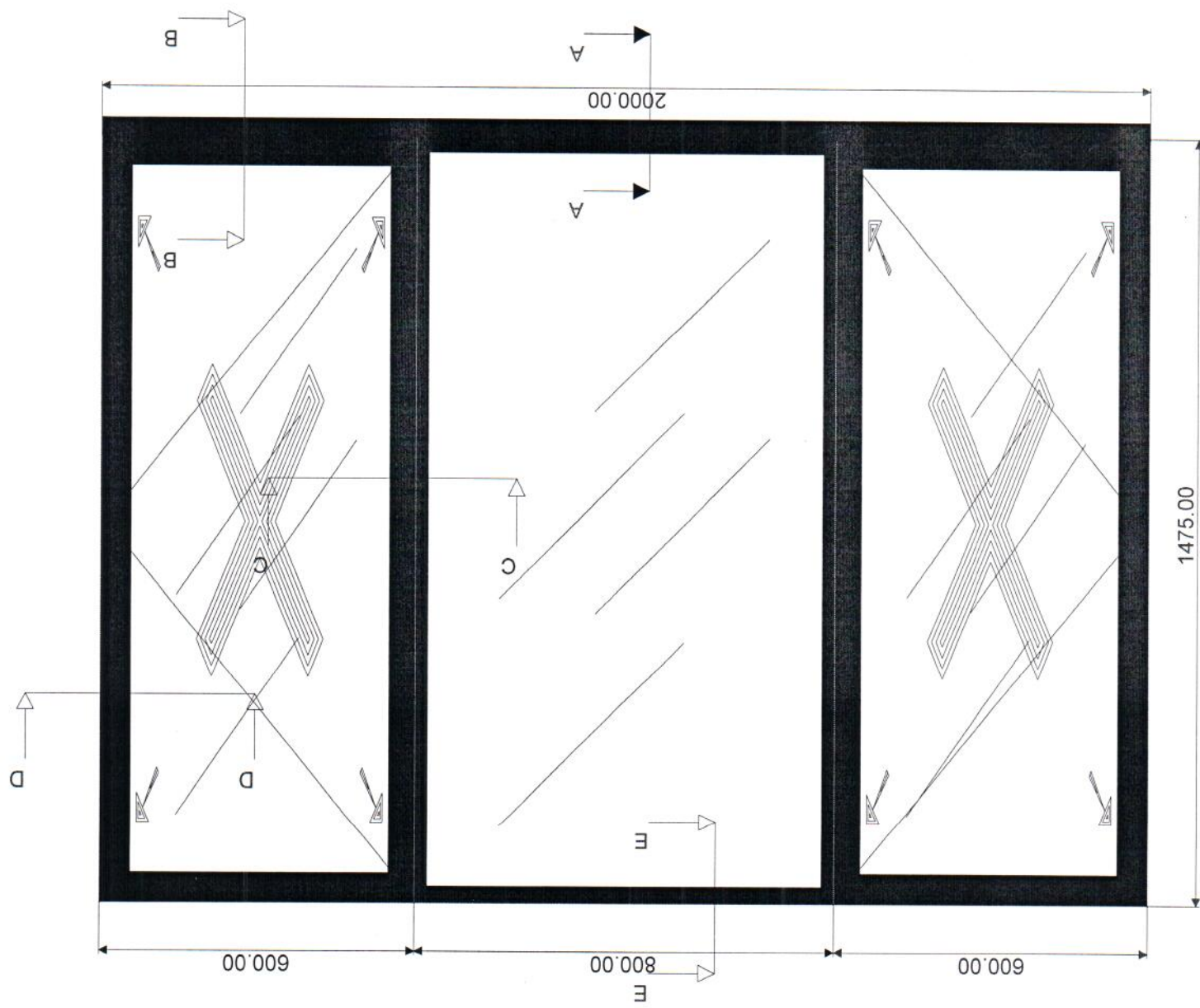

W137.

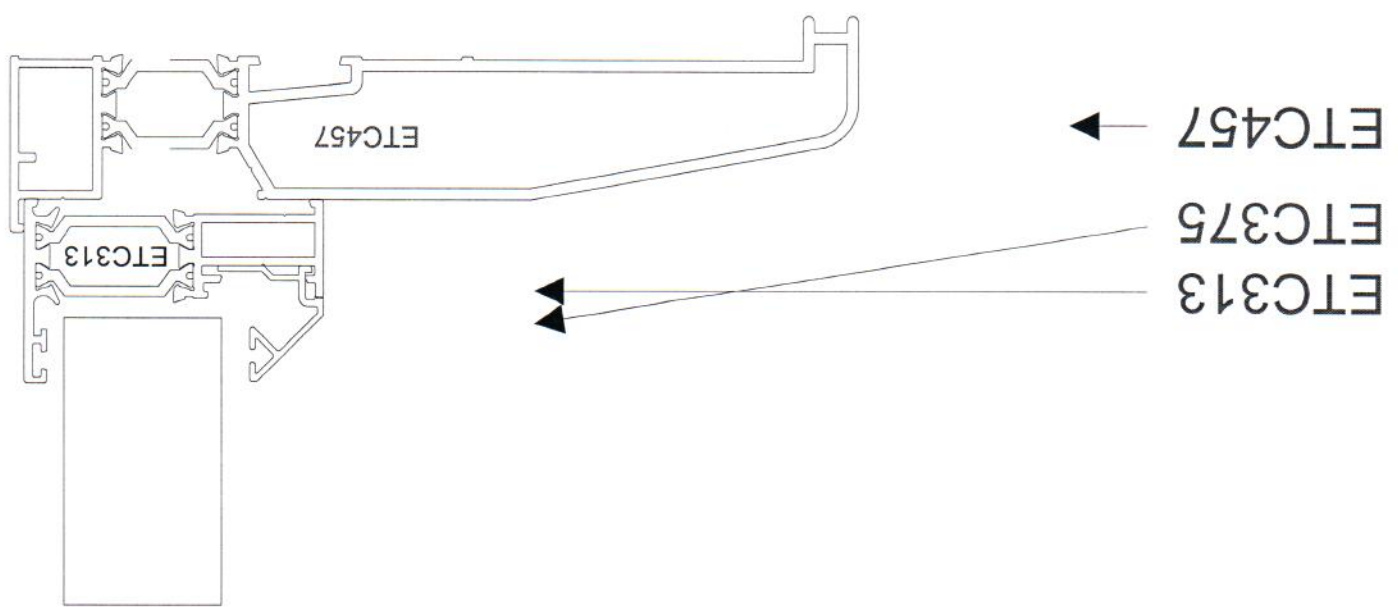

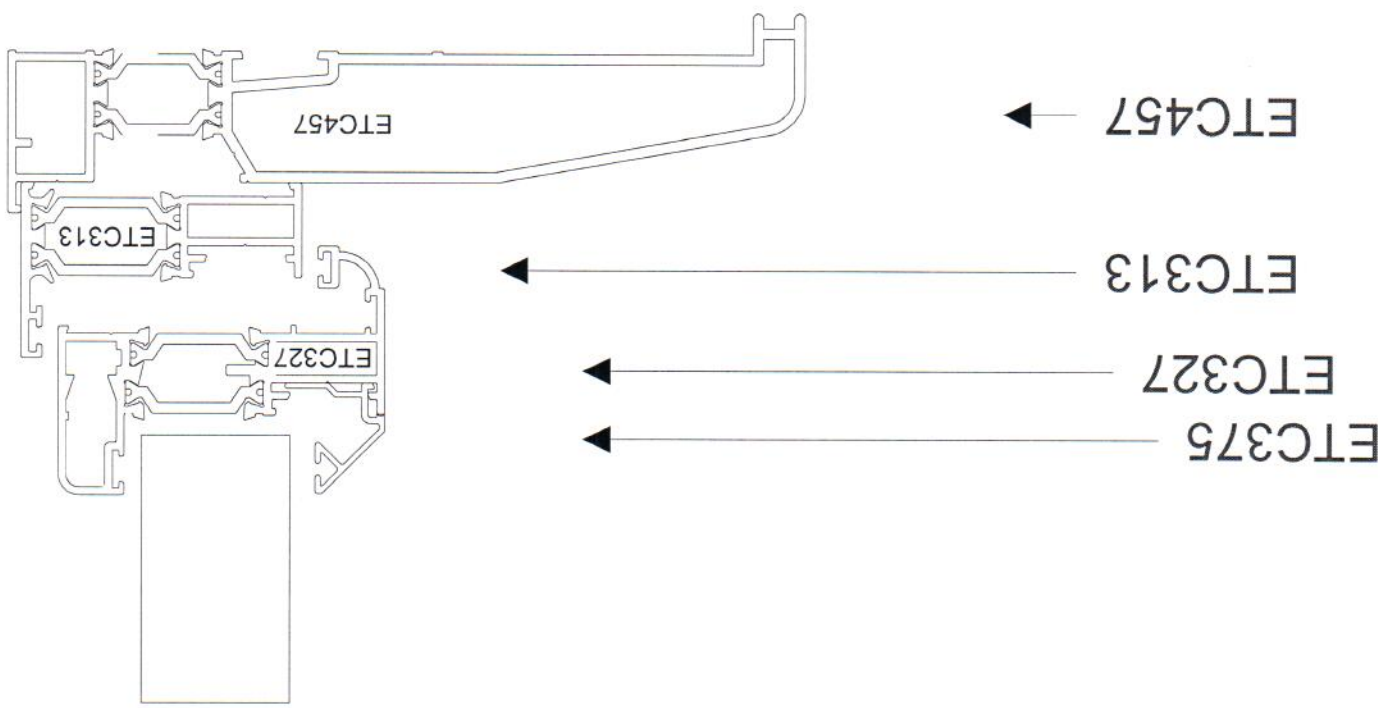

C

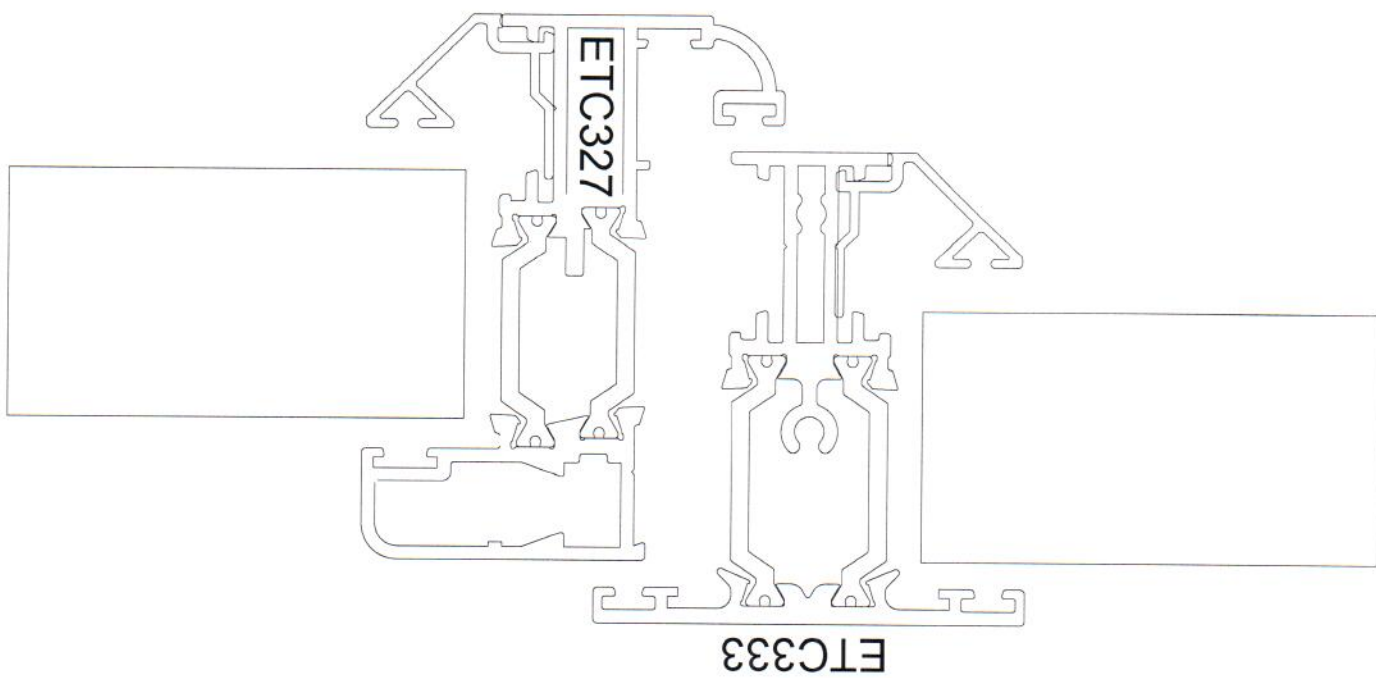

ETC375

ETC333



ETC327



ETC375

D

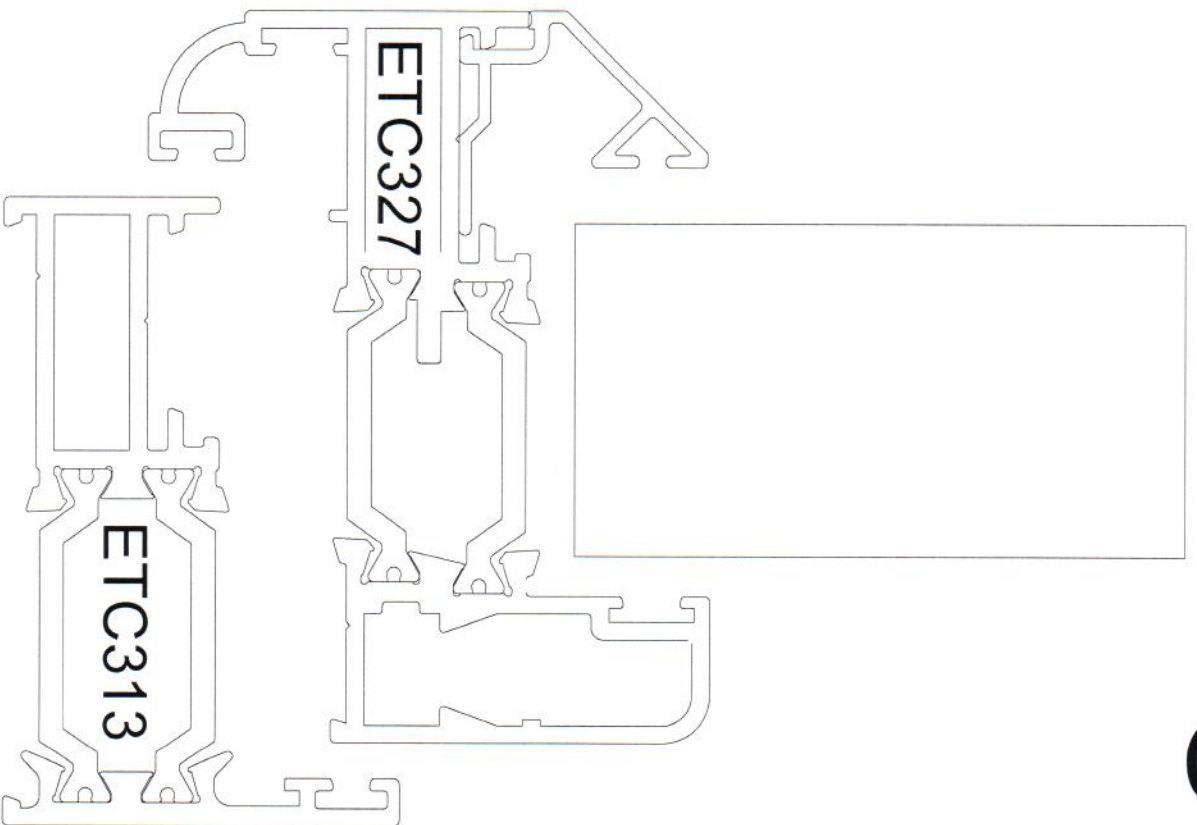

ETC375
ETC327
ETC313

Three arrows pointing downwards from the labels ETC375, ETC327, and ETC313. The arrows from ETC327 and ETC313 are positioned close together, while the arrow from ETC375 is further to the right.

ETC313
ETC375

