

OPTIONAL  
no sub cill

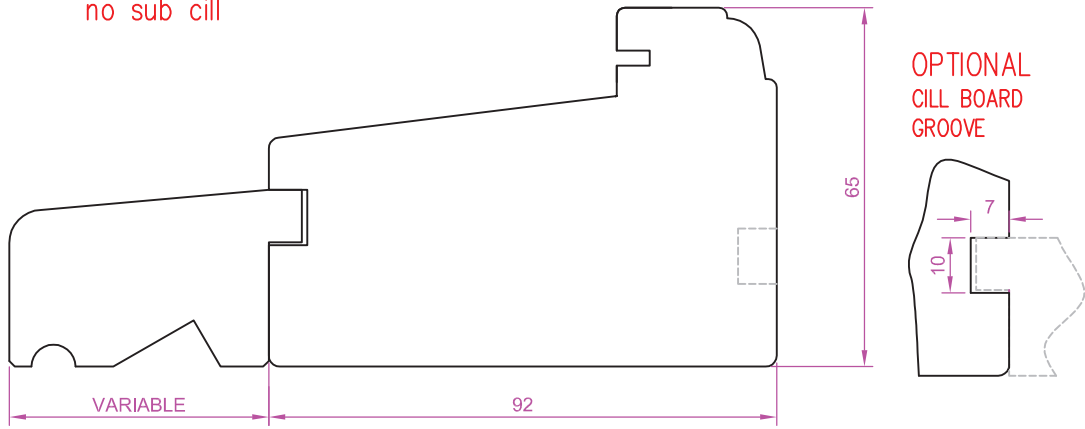

STANDARD  
one piece subcill

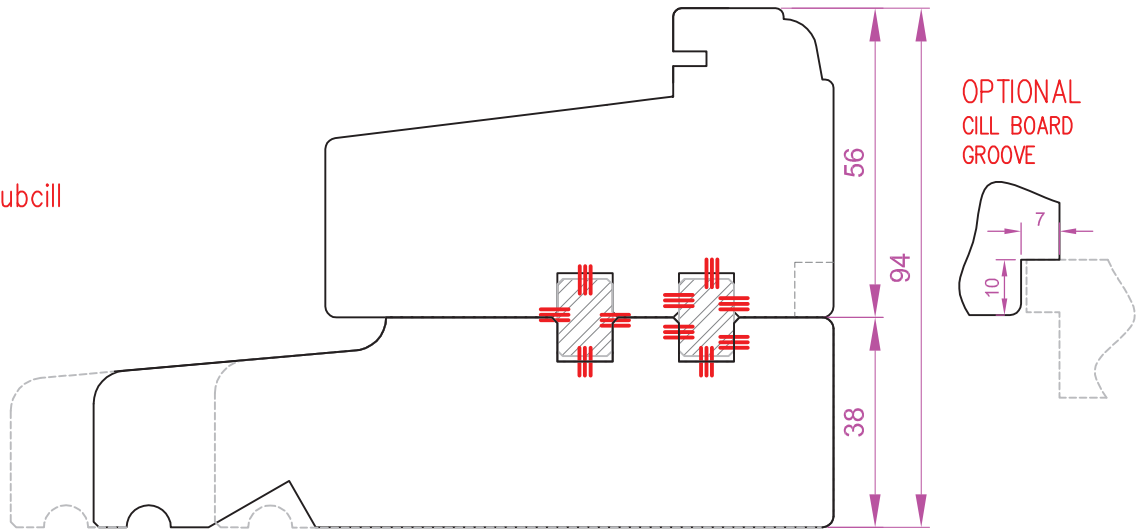

SUBCILL SIZES – 112mm / 134mm / 149mm overall

STANDARD  
subcill with cill extension

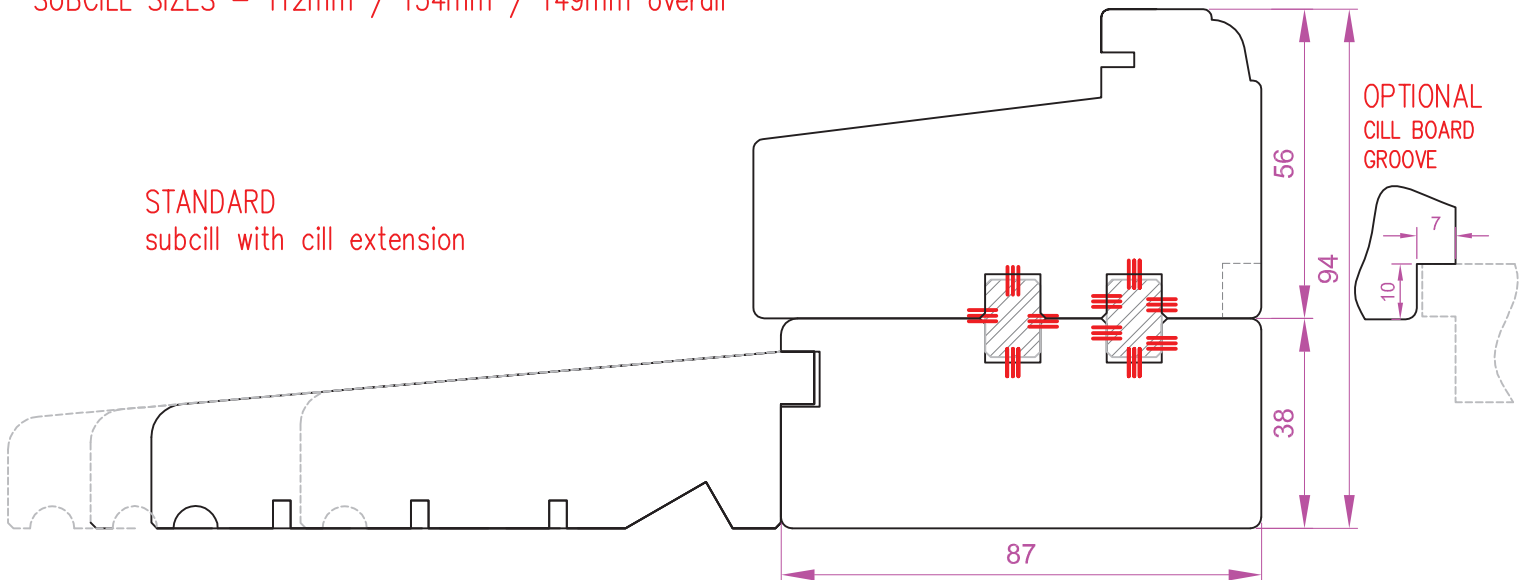

CILL EXTENSION – available options:  
 87mm (174mm overall)  
 114mm (201mm overall)  
 125mm (212mm overall)  
 140mm (227mm overall)

ALL DIMENSIONS IN mm		ORIGINAL PLOT A3 SIZE (297x420)					
SCALE	GENERAL TOLERANCE	MATERIAL					
1 : 1	+ 2	Timber					
TITLE		HERITAGE		Lee Young	17.04.2012	0	
SLIM-LINE FLUSH CASEMENT		CILL DETAILS		DRAWN BY	CHECKED	DATE	ISSUE
				DWG NO.	3101.1		SHT 1

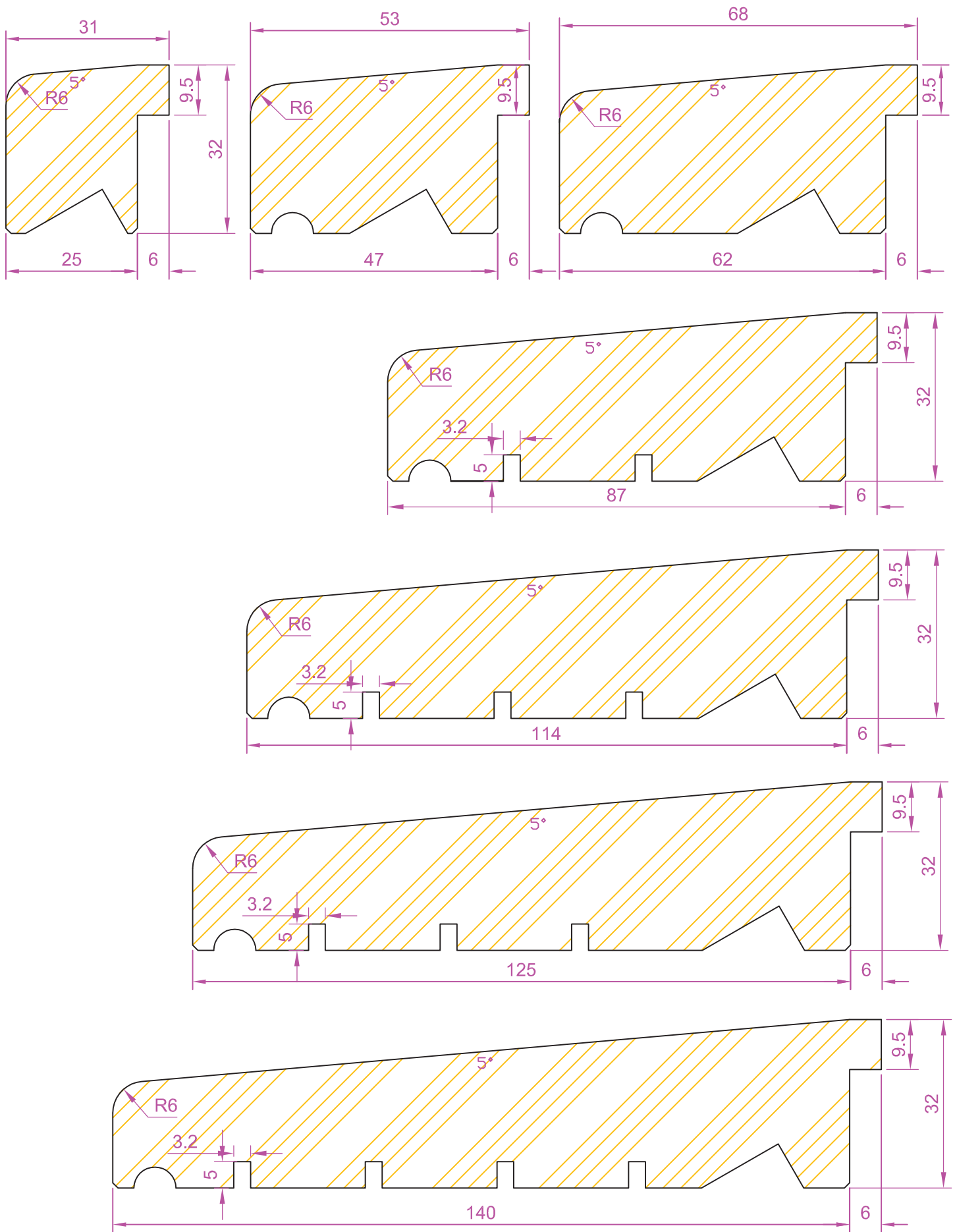

ALL DIMENSIONS IN mm		ORIGINAL PLOT A4 SIZE (210x297)					
SCALE	GENERAL TOLERANCE	MATERIAL					
1 : 1	+ 2			Lee Young	17.04.2012	0	
TITLE	HERITAGE SLIM-LINE FLUSH CASEMENT Sections - Cill Extension			DRAWN BY	CHECKED	DATE	ISSUE
				DWG NO.	3101.2		SHT 1

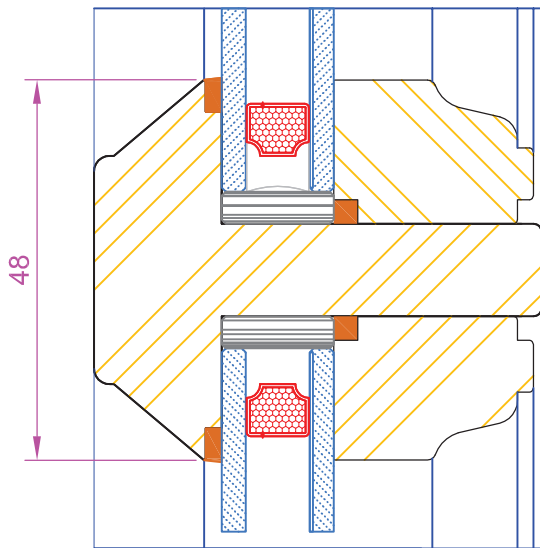

LAMBS TONGUE 48mm

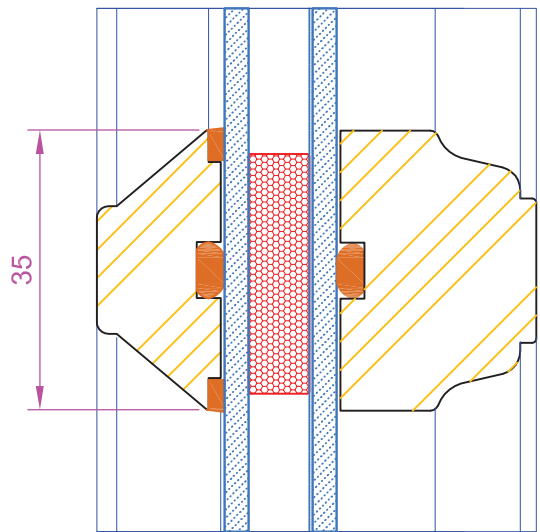

LAMBS TONGUE 35mm

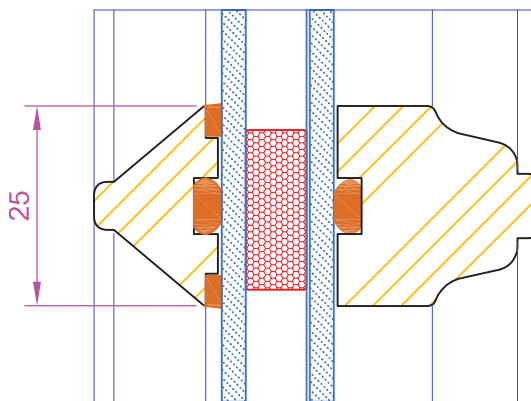

LAMBS TONGUE 25mm

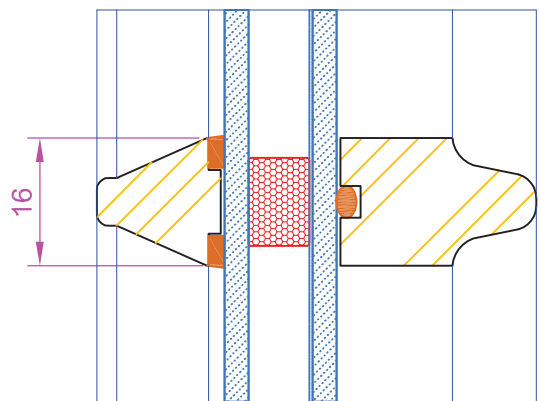

LAMBS TONGUE 16mm

ALL DIMENSIONS IN mm		ORIGINAL PLOT A4 SIZE (210x297)					
SCALE	GENERAL TOLERANCE	MATERIAL					
1 : 1	+ 2	Timber		T.Tomicki	E.Krupa	01.06.2012	
TITLE				Lee Young		17.04.2012	0
				HERITAGE		DRAWN BY	CHECKED
SLIM-LINE FLUSH CASEMENT				DWG NO.			SHT
Section Solid Bar / Stick-on-Bar				3102			1

HEAD DRIP - Included only if vents are required

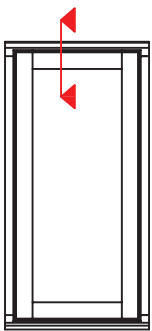
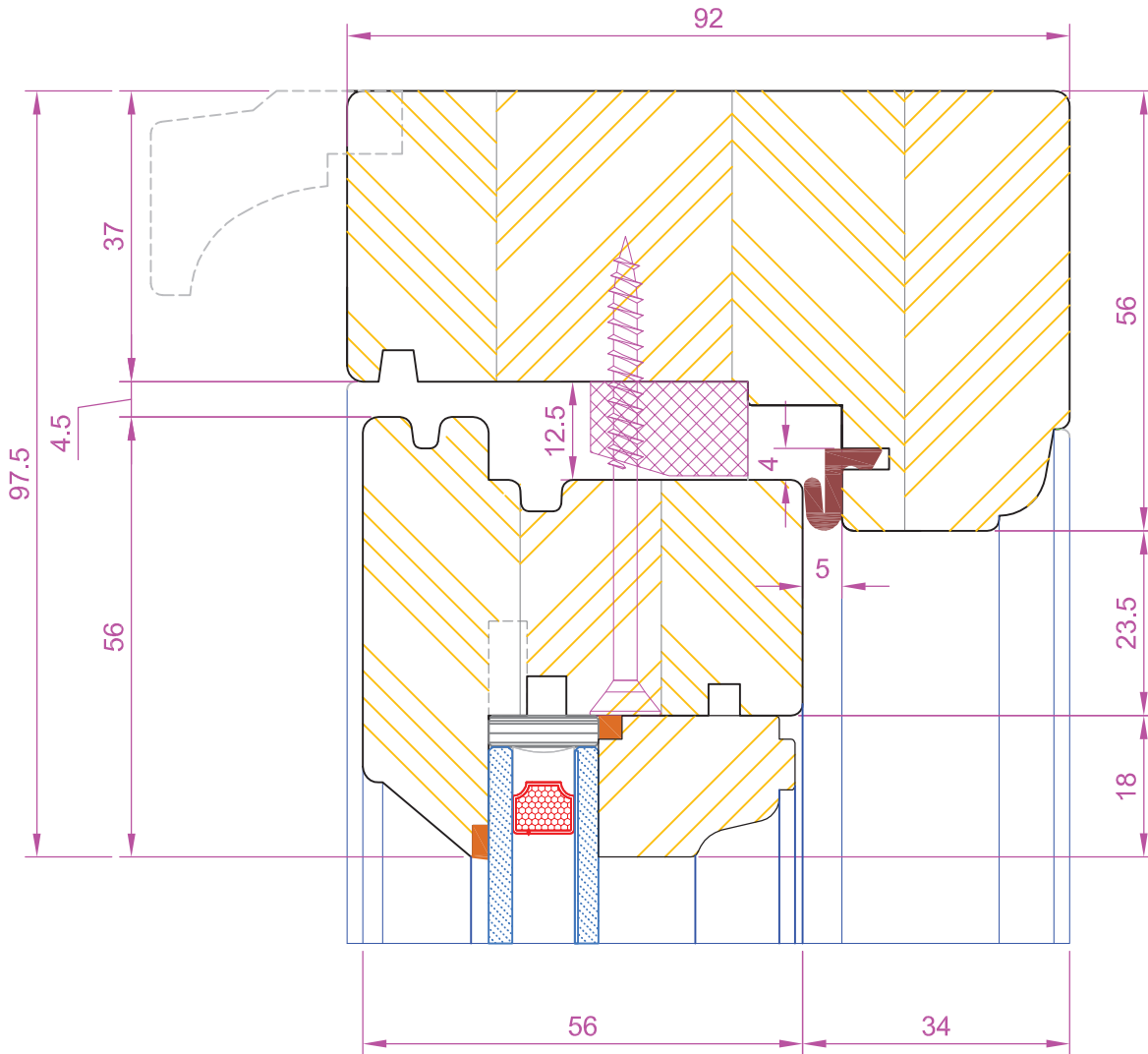

ALL DIMENSIONS IN mm ORIGINAL PLOT A4 SIZE (210x297)

SCALE  
1 : 1

GENERAL TOLERANCE  
+ 2

MATERIAL  
Timber

TITLE  
HERITAGE  
SLIM-LINE FLUSH CASEMENT  
Head Section Fixed Sash (Frame & Sash)

T.Tomicki	E.Krupa	01.06.2012	
Lee Young		17.04.2012	0
DRAWN BY	CHECKED	DATE	ISSUE
DWG NO.	3103		SHT 1

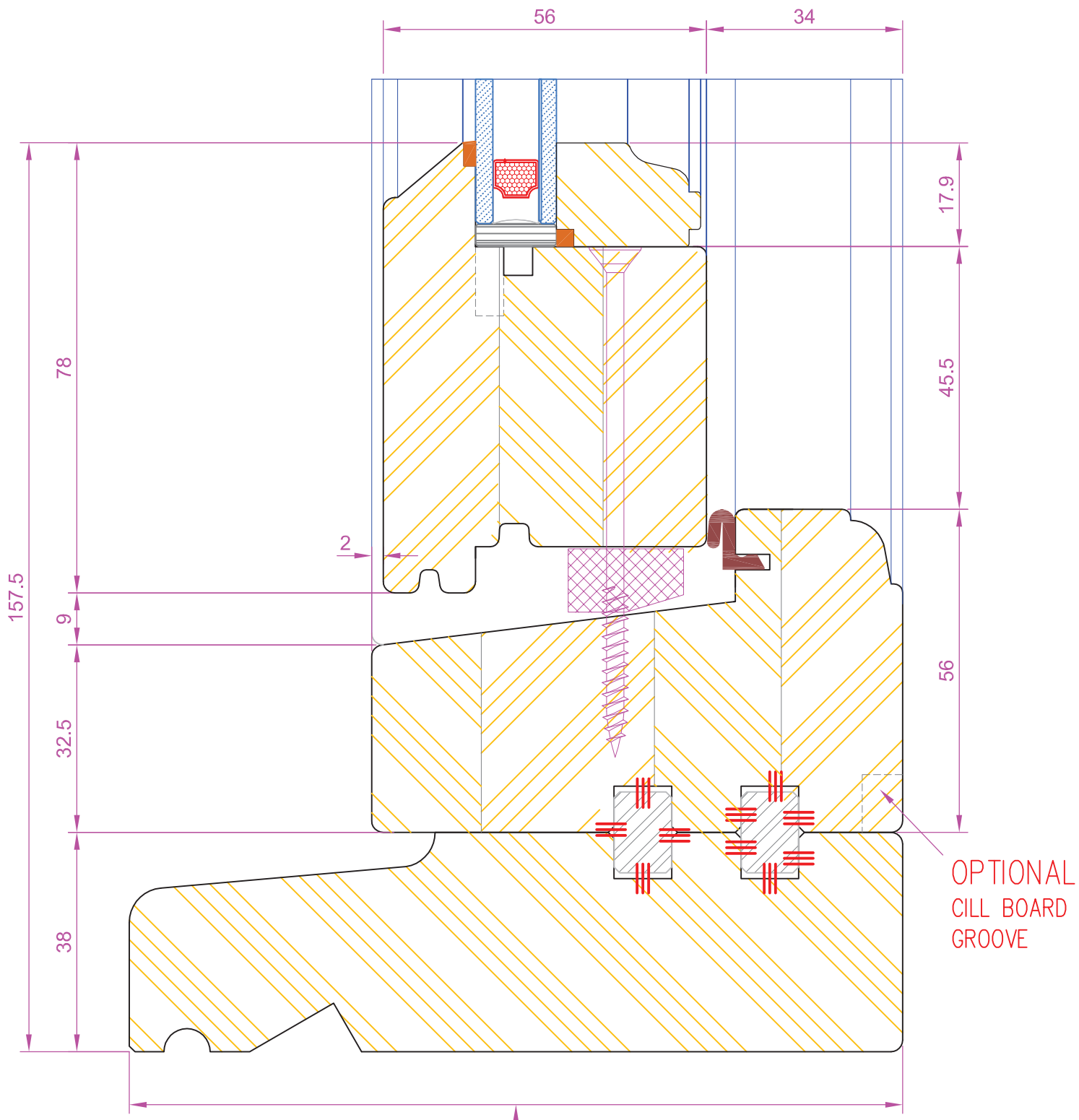

Refer to drawing numbers 1801.1 & 1801.2 for cill options

OPTIONAL  
CILL BOARD  
GROOVE



ALL DIMENSIONS IN mm		ORIGINAL PLOT A4 SIZE (210x297)					
SCALE	GENERAL TOLERANCE	MATERIAL					
1 : 1	+ 2	Timber		T.Tomicki	E.Krupa	01.06.2012	
TITLE				Lee Young		17.04.2012	0
				HERITAGE		DRAWN BY	CHECKED
SLIM-LINE FLUSH CASEMENT				DWG NO.			SHT
Cill Section Fixed Sash (Frame & Sash)				3104			1

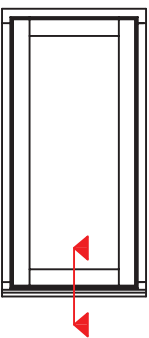
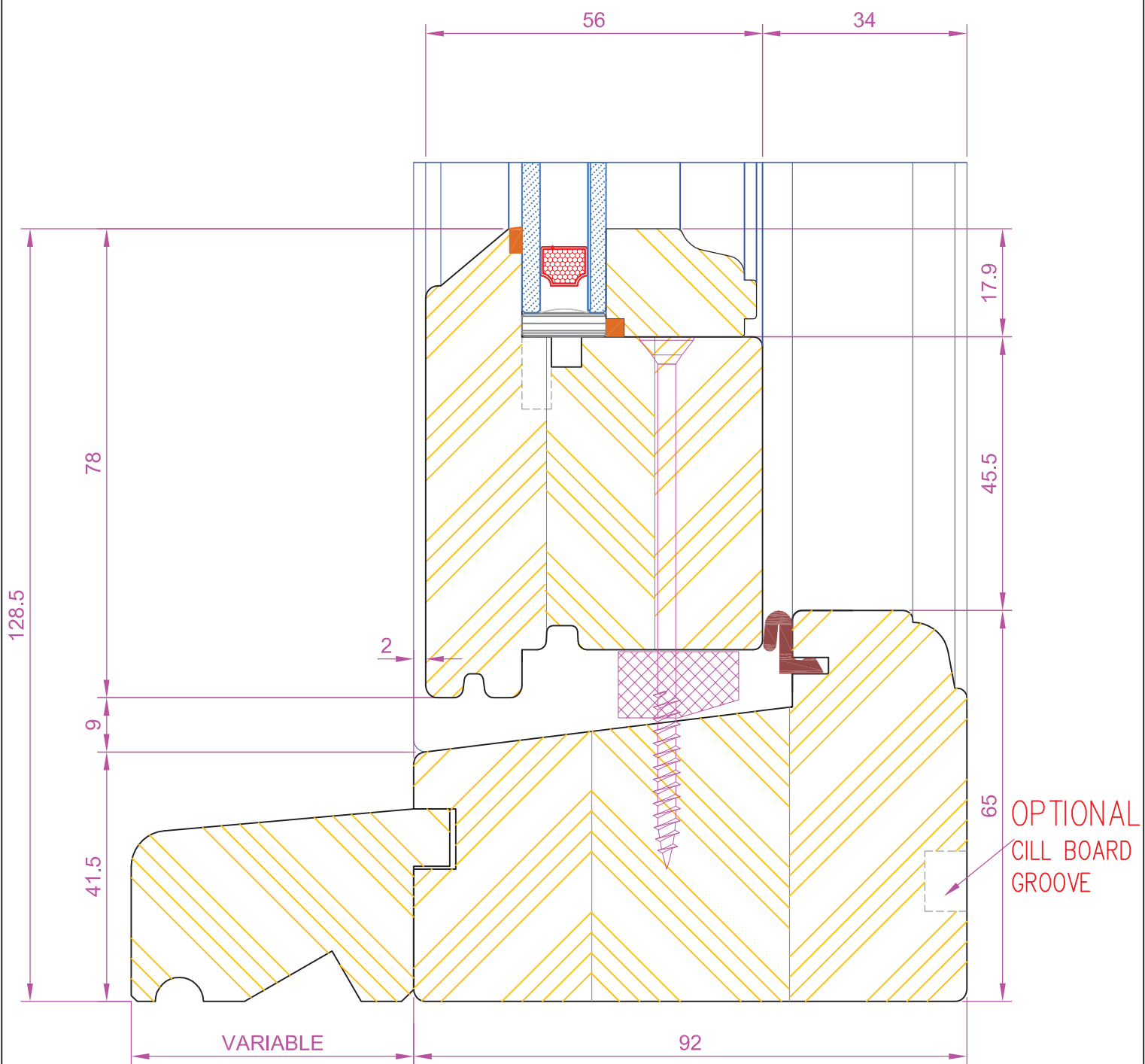

	ALL DIMENSIONS IN mm		ORIGINAL PLOT A4 SIZE (210x297)					
	SCALE	GENERAL TOLERANCE	MATERIAL					
	1 : 1	+ 2	Timber		T.Tomicki	E.Krupa	01.06.2012	
	TITLE		HERITAGE		Lee Young		17.04.2012	0
		SLIM-LINE FLUSH CASEMENT		DRAWN BY	CHECKED	DATE	ISSUE	
OPTIONAL - Cill Section Fixed Sash (Frame & Sash)				DWG NO.	3104.1		SHT 1	

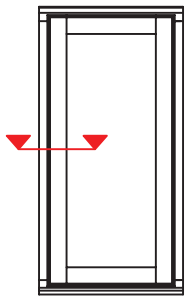
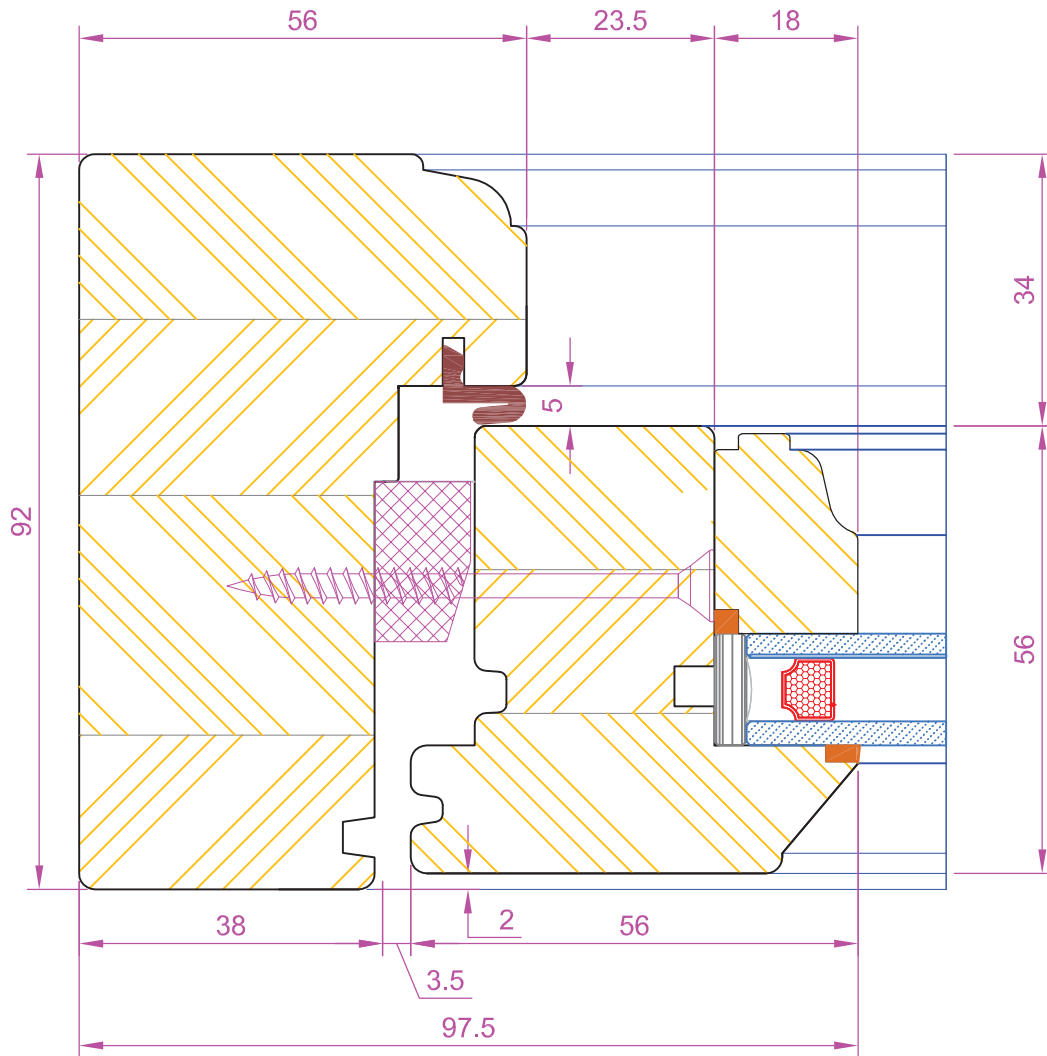

ALL DIMENSIONS IN mm ORIGINAL PLOT A4 SIZE (210x297)

SCALE 1 : 1	GENERAL TOLERANCE + 2	MATERIAL Timber
----------------	--------------------------	--------------------

TITLE  
HERITAGE  
SLIM-LINE FLUSH CASEMENT  
Jamb Section Fixed Sash (Frame & Sash)

T.Tomicki	E.Krupa	01.06.2012	
Lee Young		17.04.2012	0
DRAWN BY	CHECKED	DATE	ISSUE
DWG NO.	3105		SHT

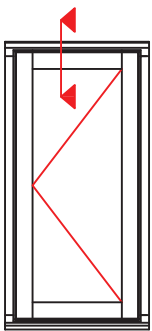
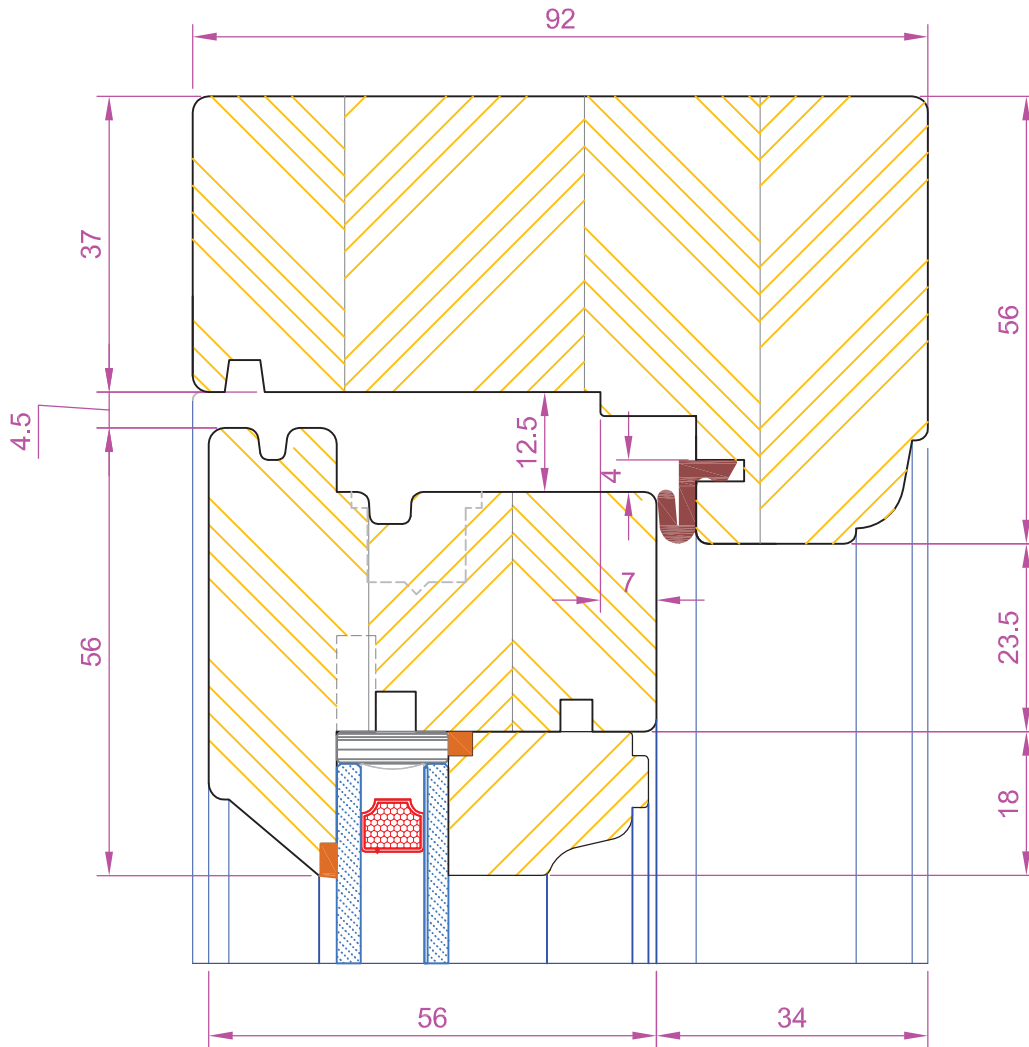

ALL DIMENSIONS IN mm ORIGINAL PLOT A4 SIZE (210x297)

SCALE 1 : 1	GENERAL TOLERANCE + 2	MATERIAL Timber
----------------	--------------------------	--------------------

TITLE  
HERITAGE  
SLIM-LINE FLUSH CASEMENT  
Head Section Frame & Sash (Without Vent)

T.Tomicki	E.Krupa	01.06.2012	
Lee Young		17.04.2012	0
DRAWN BY	CHECKED	DATE	ISSUE
DWG NO.	3106		SHT 1



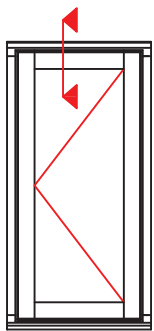
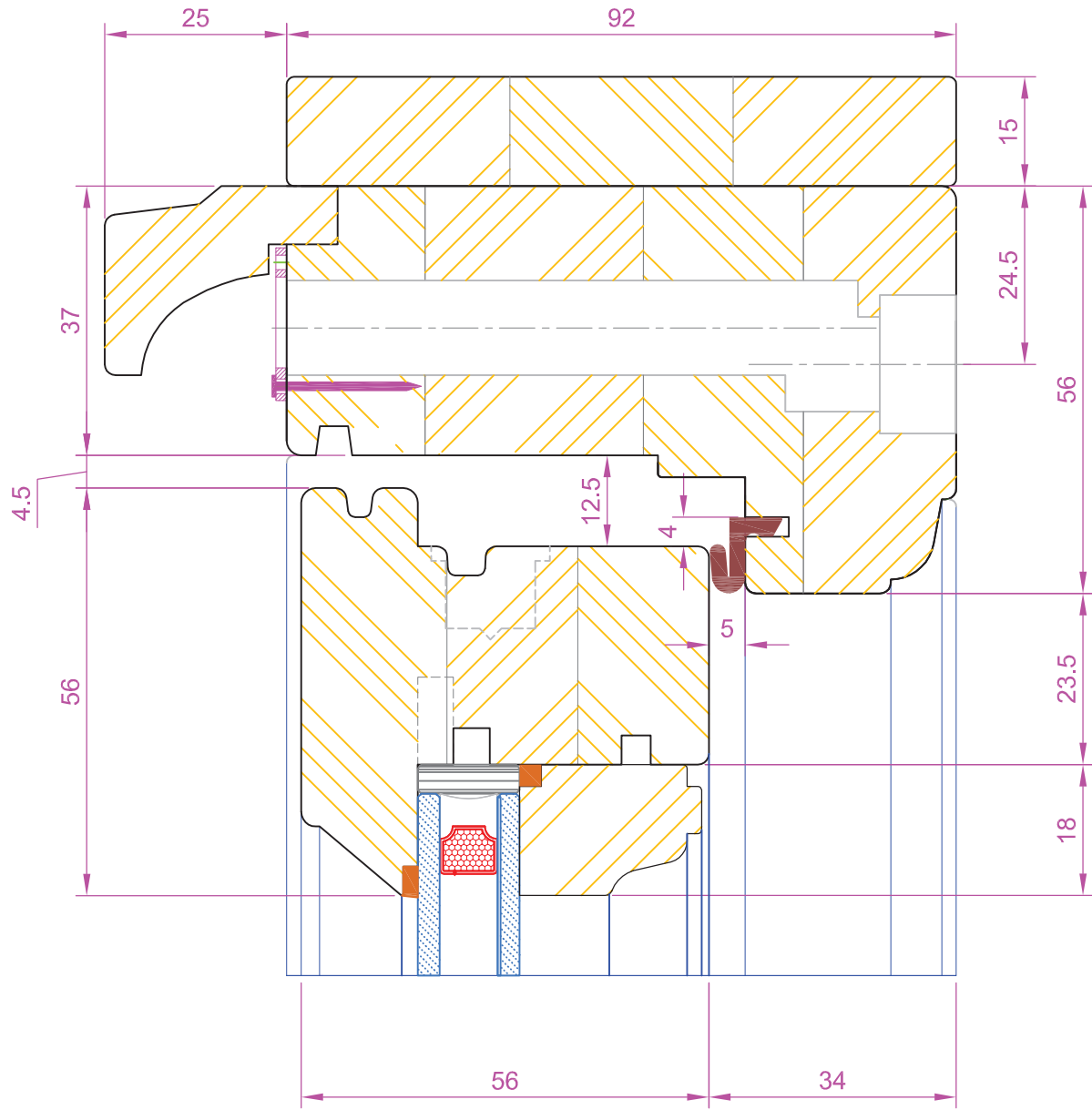

ALL DIMENSIONS IN mm ORIGINAL PLOT A4 SIZE (210x297)

SCALE 1 : 1	GENERAL TOLERANCE + 2	MATERIAL Timber
----------------	--------------------------	--------------------

TITLE  
**HERITAGE**  
**SLIM-LINE FLUSH CASEMENT**  
Head Section Frame & Sash With 15mm Timber Packer

T.Tomicki	E.Krupa	01.06.2012	
Lee Young		17.04.2012	0
DRAWN BY	CHECKED	DATE	ISSUE
DWG NO.	3106.1		SHT 1

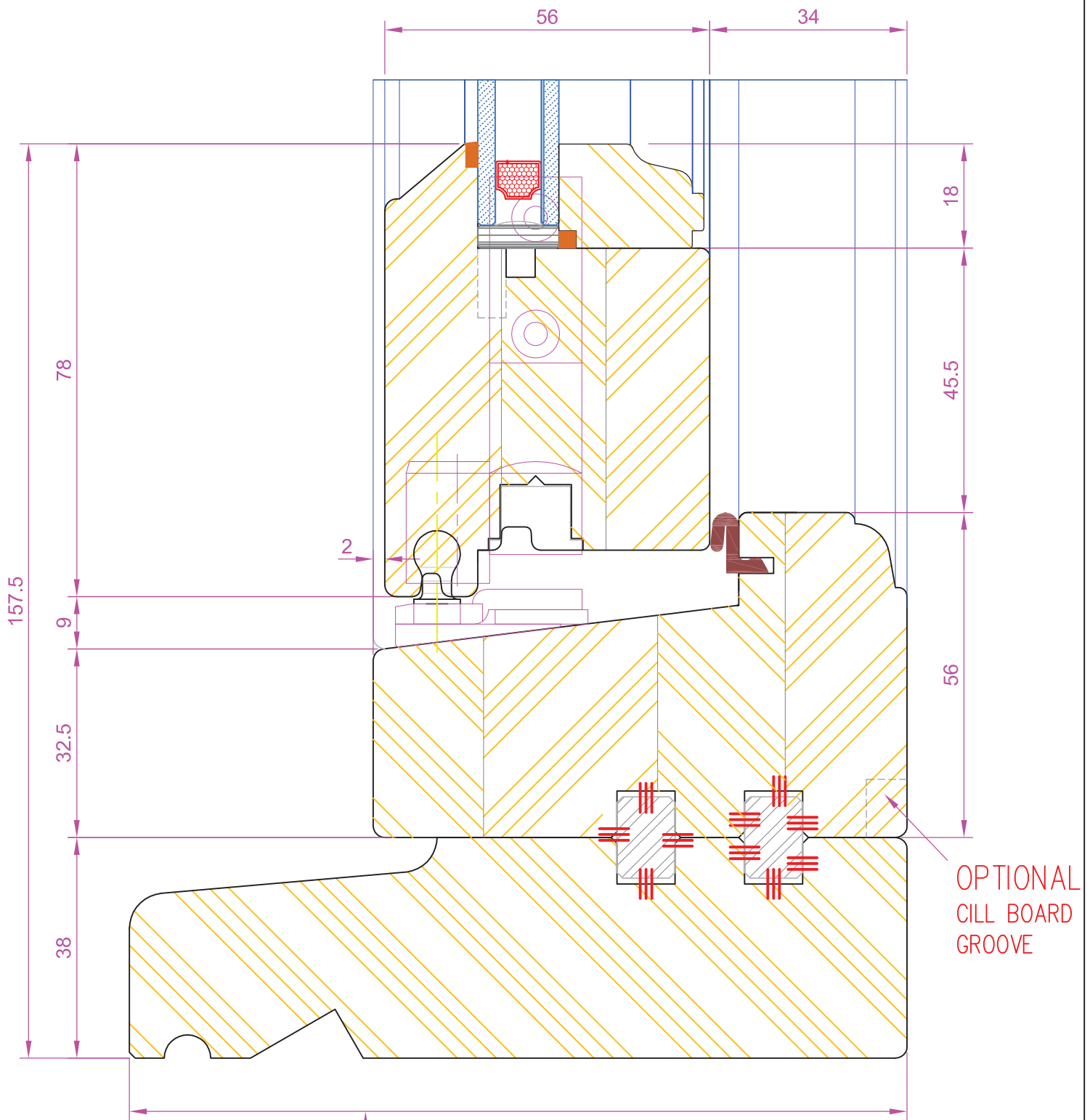

Refer to drawing numbers 1801.1 & 3101.2 for cill options

**CILL EXTENSION - available options:**  
 25mm (112mm o/a) / 47mm (134mm o/a) / 62mm (149mm o/a) /  
 87mm (174mm o/a) / 114mm (201mm o/a) / 125mm (212mm o/a) /  
 140mm (227mm o/a)

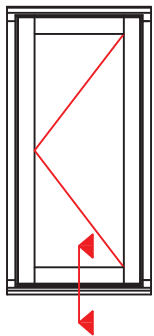

ALL DIMENSIONS IN mm		ORIGINAL PLOT A4 SIZE (210x297)					
SCALE	GENERAL TOLERANCE	MATERIAL					
1 : 1	+ 2	Timber		T.Tomicki	E.Krupa	01.06.2012	
TITLE				Lee Young		17.04.2012	0
HERITAGE				DRAWN BY	CHECKED	DATE	ISSUE
SLIM-LINE FLUSH CASEMENT				DWG NO.	3107		SHT
Cill Section Frame & Sash (side hung)							1

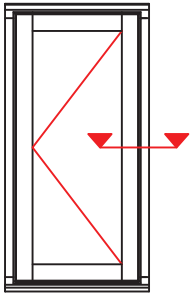
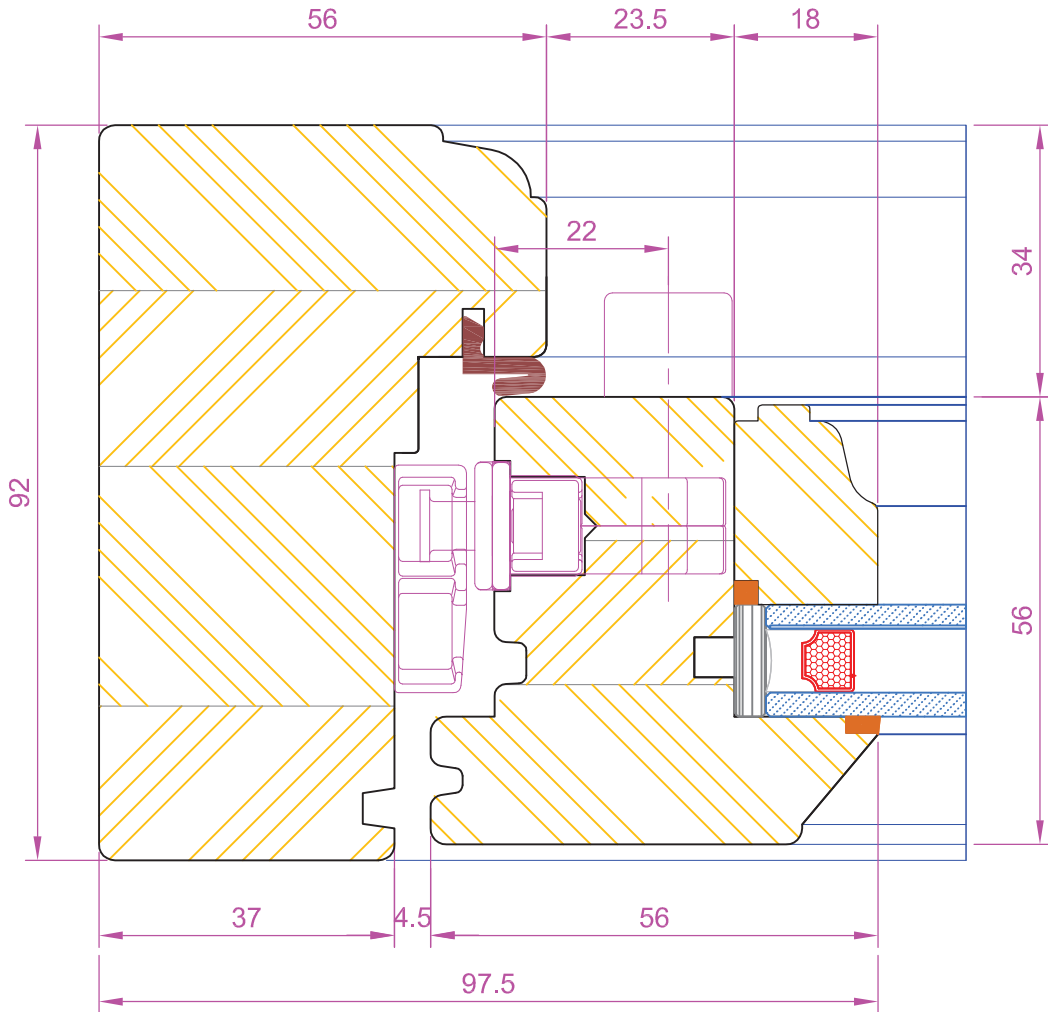

ALL DIMENSIONS IN mm ORIGINAL PLOT A4 SIZE (210x297)

SCALE  
1 : 1

GENERAL TOLERANCE  
+ 2

MATERIAL  
Timber

TITLE  
SLIM-LINE FLUSH CASEMENT  
Jamb Section Frame & Sash (Handle Side)

T.Tomicki	E.Krupa	01.06.2012	
Lee Young		17.04.2012	0
DRAWN BY	CHECKED	DATE	ISSUE
DWG NO.	3108		SHT 1

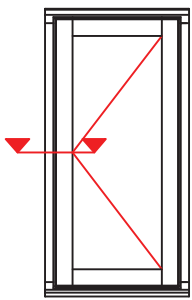
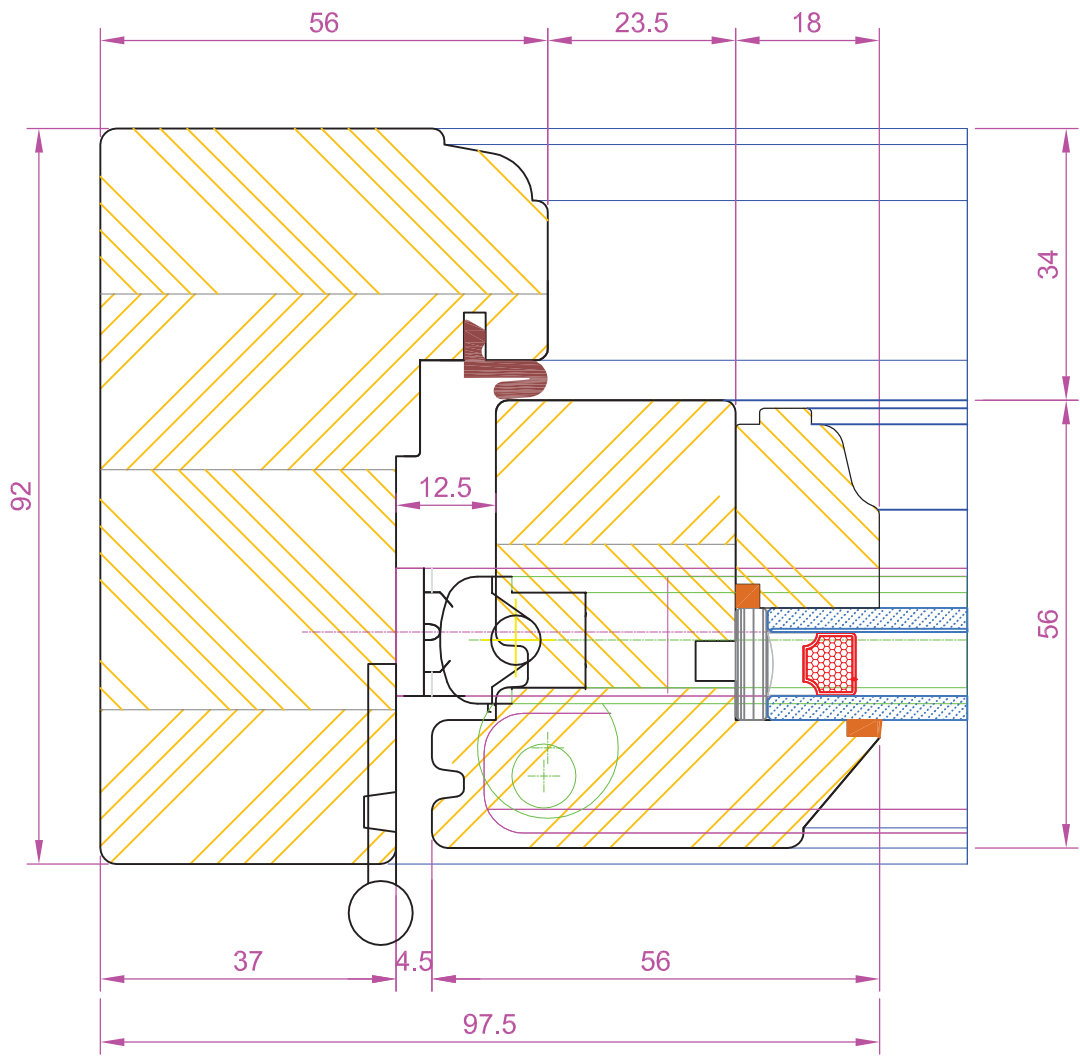

ALL DIMENSIONS IN mm		ORIGINAL PLOT A4 SIZE (210x297)					
SCALE	GENERAL TOLERANCE	MATERIAL					
1 : 1	+ 2	Timber		T.Tomicki	E.Krupa	01.06.2012	
TITLE HERITAGE SLIM-LINE FLUSH CASEMENT S Jamb Section Frame & Sash (Hinge Side)				Lee Young		17.04.2012	0
				DRAWN BY	CHECKED	DATE	ISSUE
				DWG NO. 3109			SHT 1

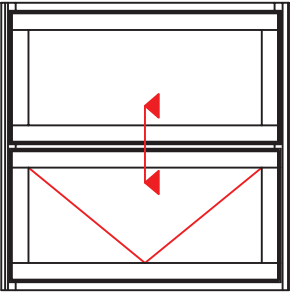
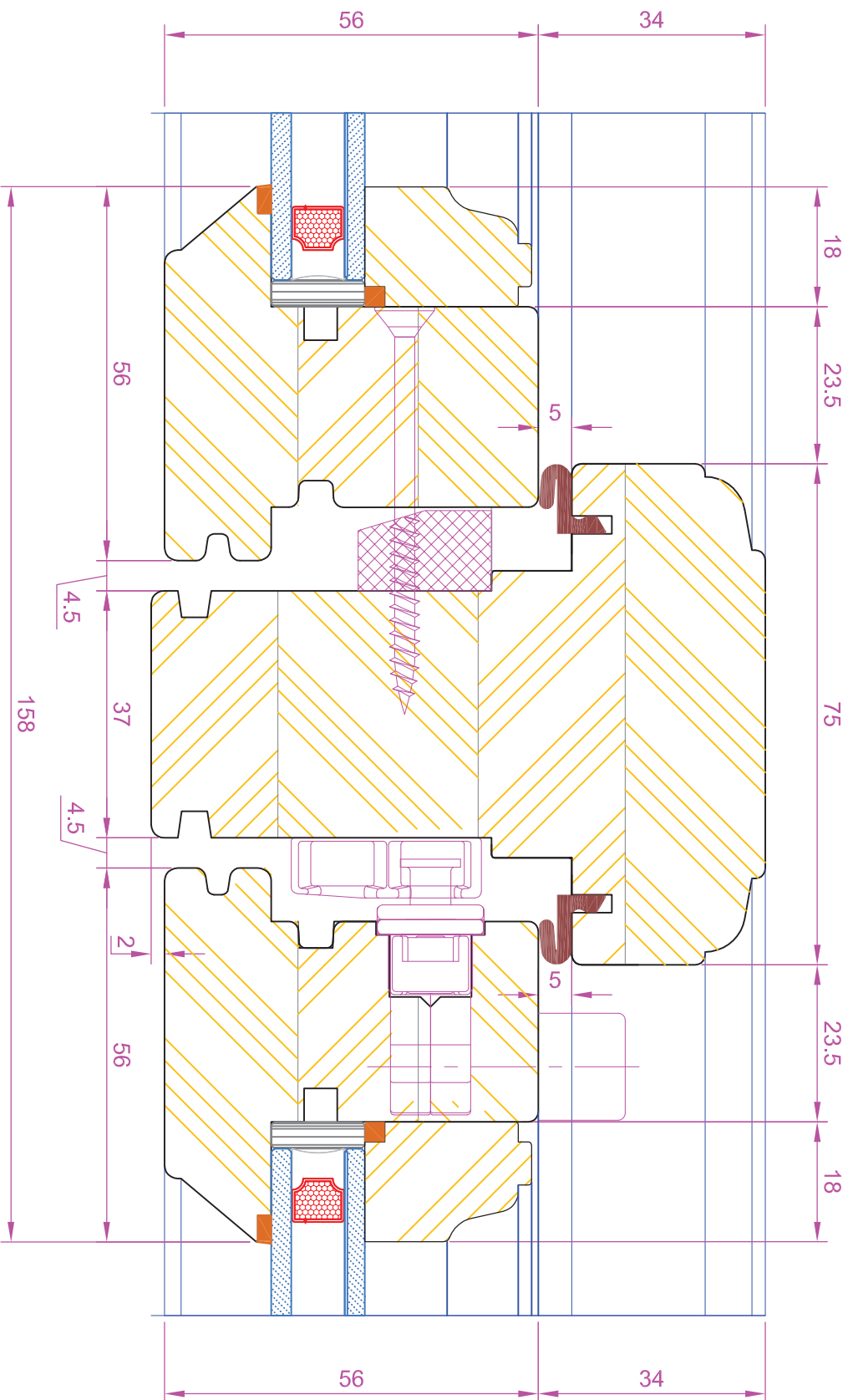

 <b>Bereco</b> DELIVERING THE DIFFERENCE		ALL DIMENSIONS IN mm ORIGINAL PLOT A4 SIZE (210x297)	
SCALE	GENERAL TOLERANCE	MATERIAL	HERITAGE
1 : 1	+ 2	Timber	Slim-Line Flush Casement
TITLE		Solid Mullion Section (Fixed Sash / Sash)	
DRAWN BY	CHECKED	DATE	ISSUE
T.Tornicki Lee Young	E.Kruppa	01.06.2012 17.04.2012	0
DWG NO.		3110	

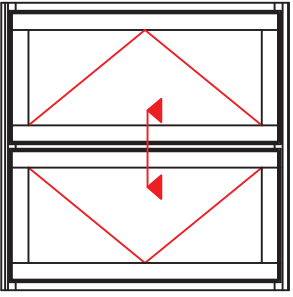
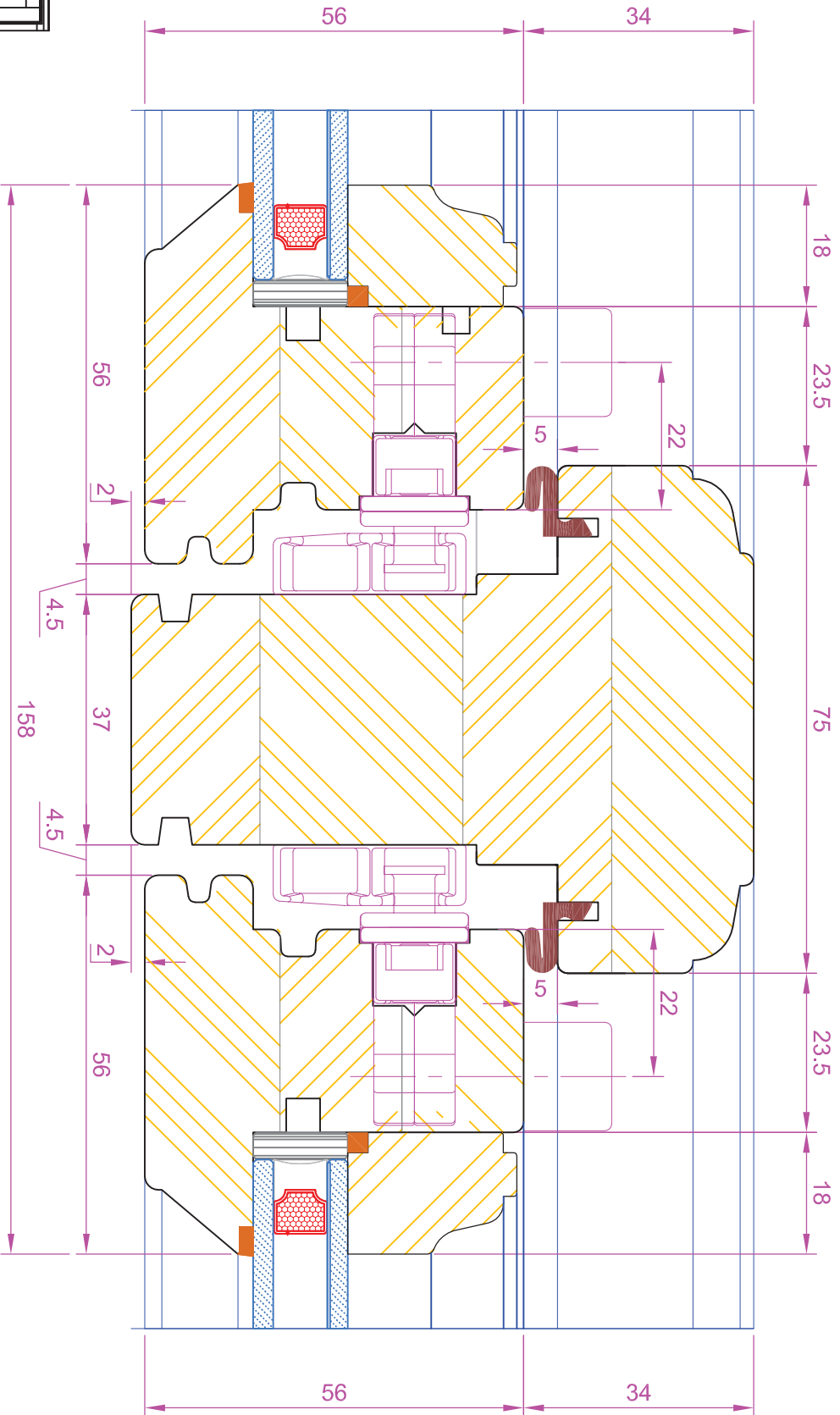

 <b>Bereco</b> DELIVERING THE DIFFERENCE		ALL DIMENSIONS IN mm ORIGINAL PLOT A4 SIZE (210x297)	
SCALE	GENERAL TOLERANCE	MATERIAL	HERITAGE
1 : 1	+ 2	Timber	SLIM-LINE FLUSH CASEMENT
TITLE		Solid Mullion Section (Sash / Sash)	
DWG NO.	DRAWN BY	CHECKED	DATE
3111	T.Tornicki Lee Young	E.Krupa	01.06.2012 17.04.2012
SHT		ISSUE	
1		0	

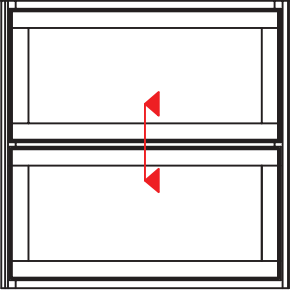
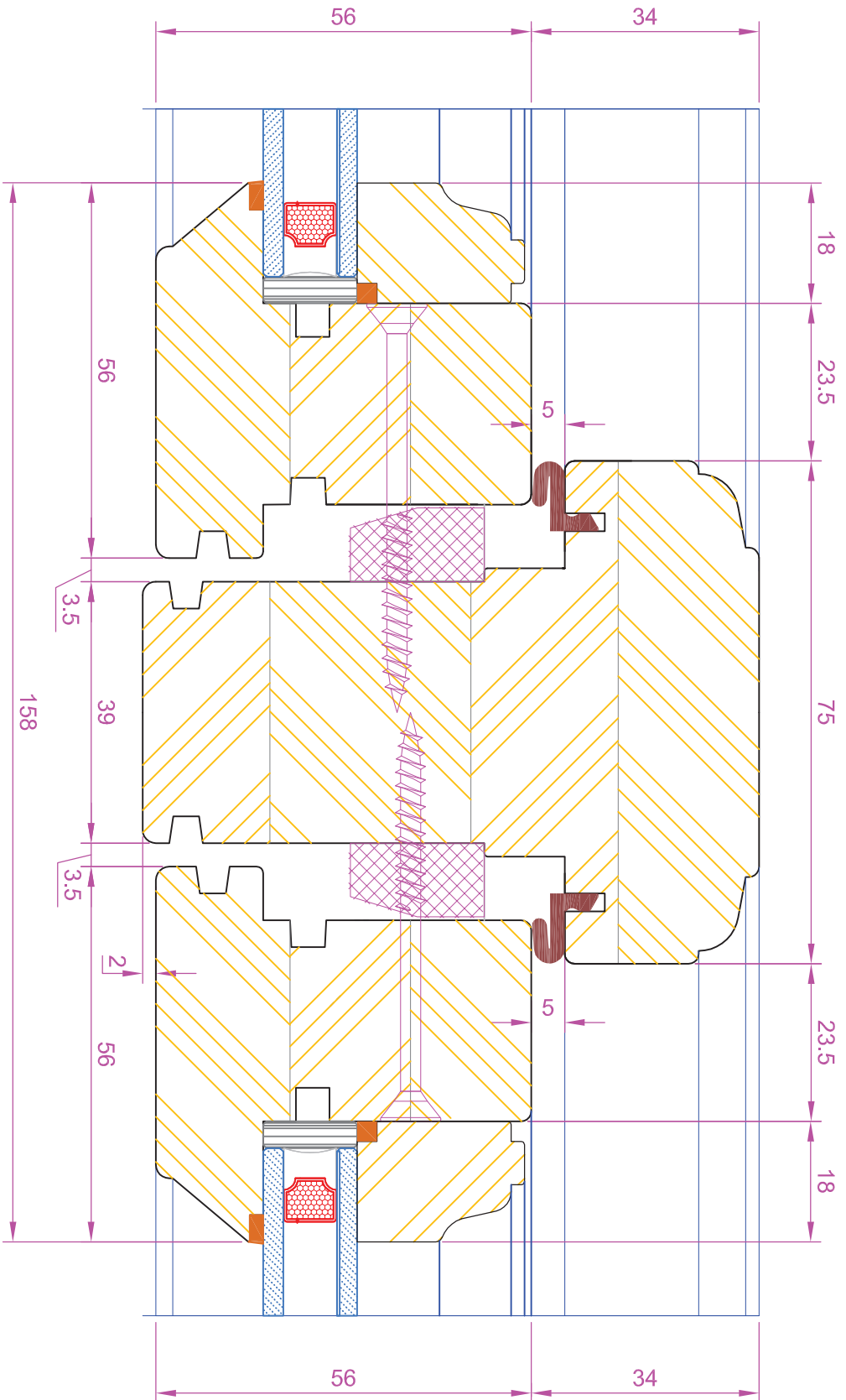

 <b>Bereco</b> DELIVERING THE DIFFERENCE		ALL DIMENSIONS IN mm ORIGINAL PLOT A4 SIZE (210x297)	
SCALE	GENERAL TOLERANCE	MATERIAL	TITLE
1 : 1	+ 2	Timber	HERITAGE SLIM-LINE FLUSH CASEMENT Solid Mullion Section (Fixed Sash/Fixed Sash)
DRAWN BY	CHECKED	DATE	ISSUE
T.Tornicki Lee Young	E.Krupa	01.06.2012 17.04.2012	0
DWG NO.	3112		SHT 1

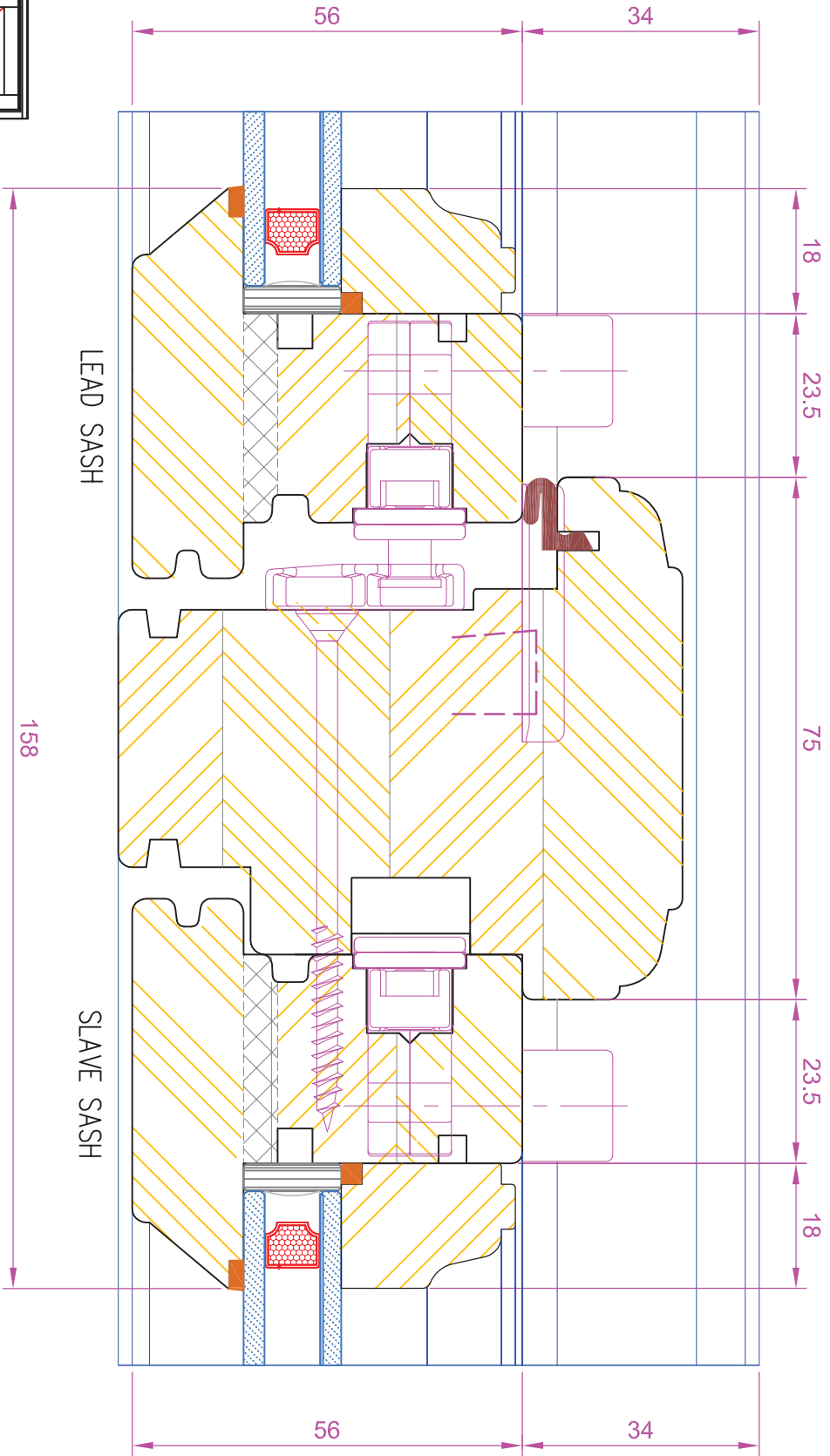
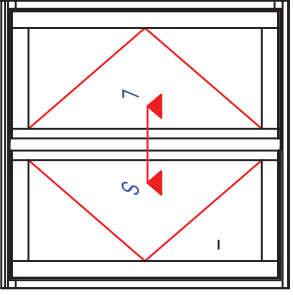

ALL DIMENSIONS IN mm		ORIGINAL PLOT A4 SIZE (210x297)	
SCALE	GENERAL TOLERANCE	MATERIAL	HERITAGE
1 : 1	+ 2	Timber	SLIM-LINE FLUSH CASEMENT
TITLE		Flying Mullion Section (Lead Sash/Slave Sash)	
DRAWN BY	CHECKED	DATE	ISSUE
T.Tornicki Lee Young	E.Krupa	01.06.2012 17.04.2012	0
DWG NO.	3113.1		SHT 1



**Bereco**

DELIVERING THE DIFFERENCE



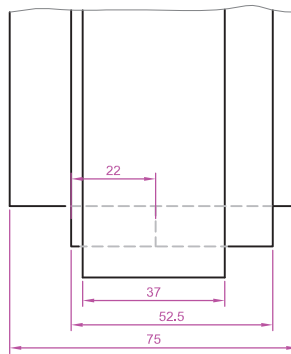
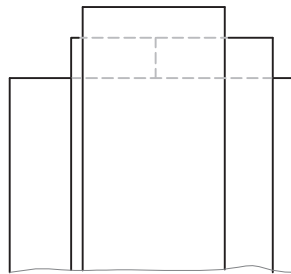
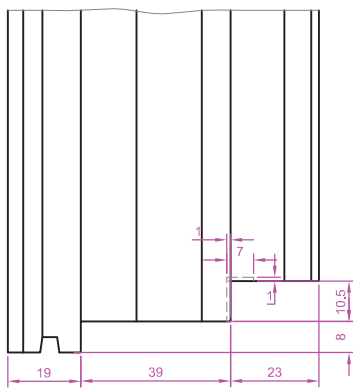
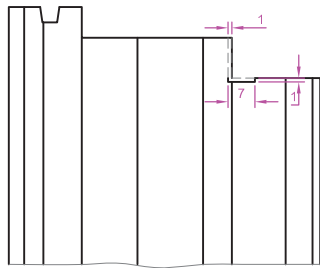
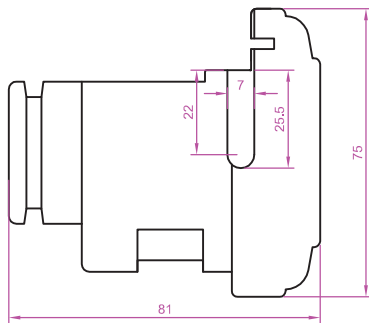

OSŁONKA Q-LON MIS 9185

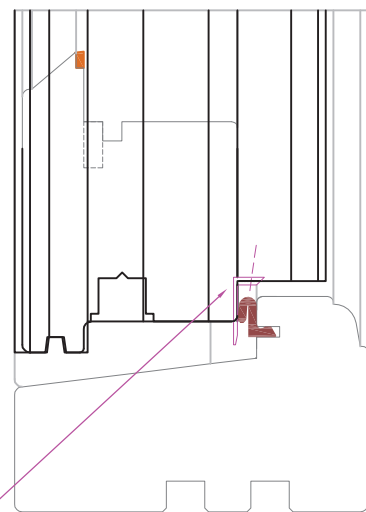
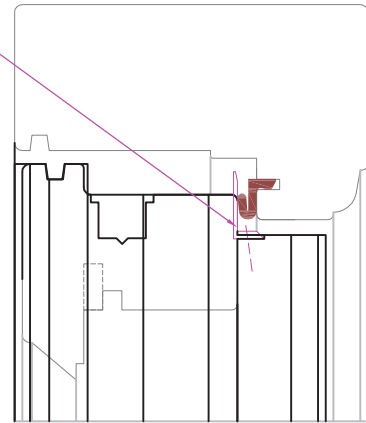

OSŁONKA Q-LON MIS 9185



ALL DIMENSIONS IN mm		ORIGINAL PLOT A2 SIZE (420x594)					
SCALE	GENERAL TOLERANCE	MATERIAL					
1 : 1	+ 2	Timber		T.Tomiccki	E.Krupa	01.06.2012	1
				L.Young		17.04.2012	0
TITLE			HERITAGE	DRAWN BY	CHECKED	DATE	ISSUE
SLIM-LINE FLUSH CASEMENT							SHT
Vertical Section Through Flying Mullion				DWG NO.	3113.2		1

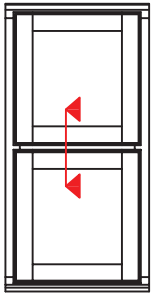
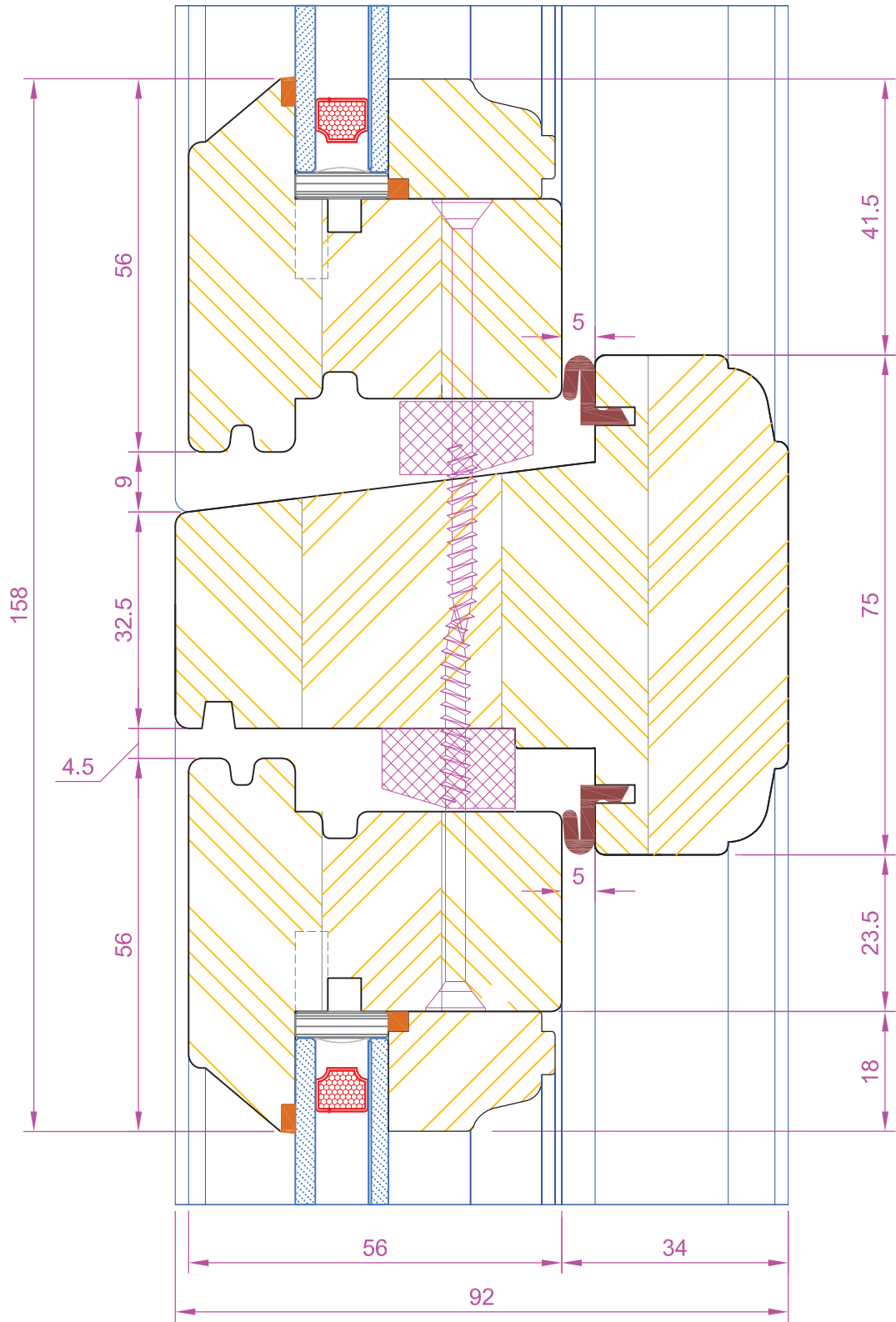

ALL DIMENSIONS IN mm ORIGINAL PLOT A4 SIZE (210x297)

SCALE  
1 : 1

GENERAL TOLERANCE  
+ 2

MATERIAL  
Timber

TITLE  
**HERITAGE**  
**SLIM-LINE FLUSH CASEMENT**  
Solid Transom Section (Fixed Sash / Fixed Sash)

T.Tomicki	E.Krupa	01.06.2012	
Lee Young		17.04.2012	0
DRAWN BY	CHECKED	DATE	ISSUE
DWG NO.	3114		SHT

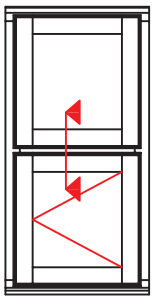
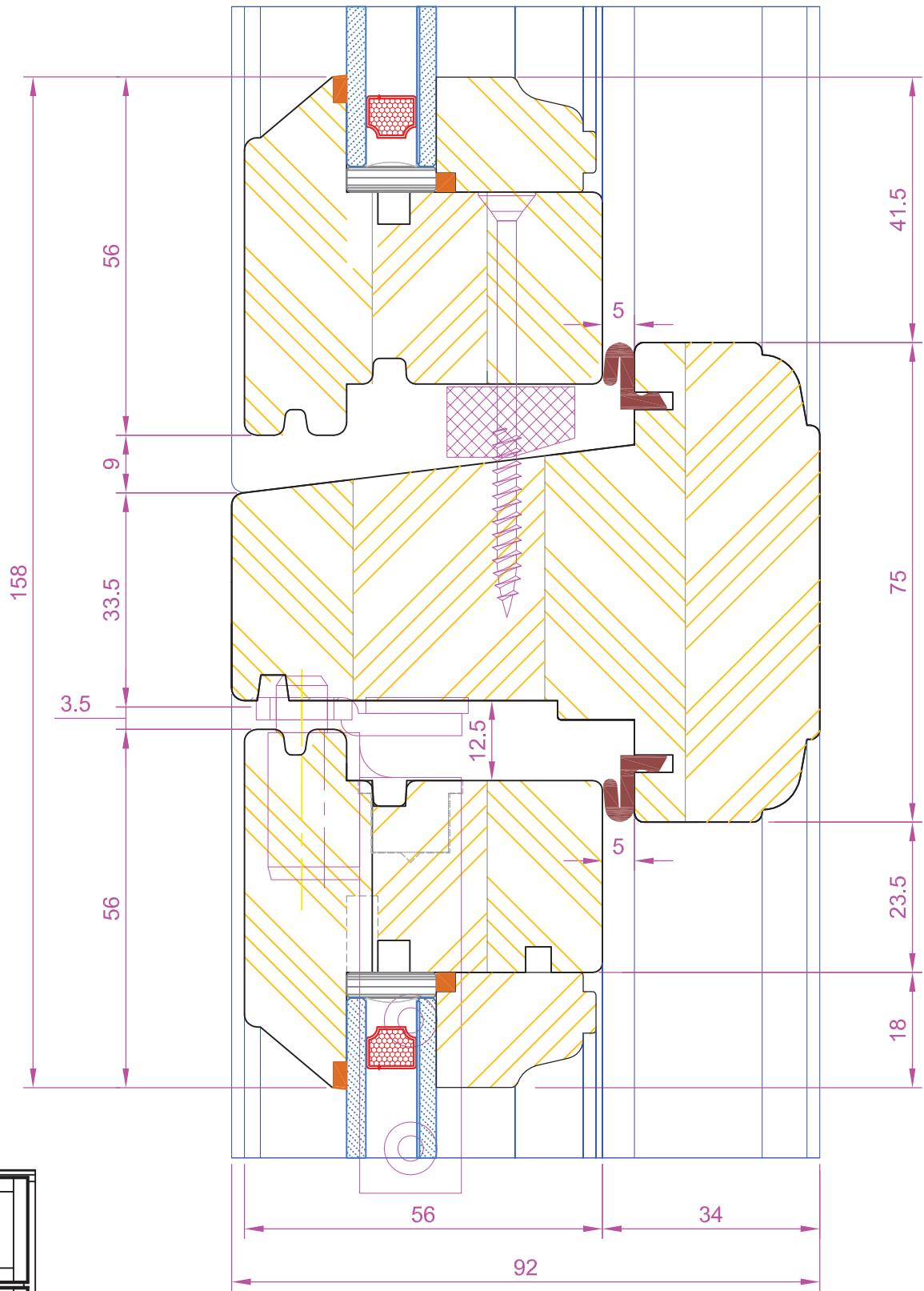

ALL DIMENSIONS IN mm ORIGINAL PLOT A4 SIZE (210x297)

SCALE 1 : 1	GENERAL TOLERANCE + 2	MATERIAL Timber
----------------	--------------------------	--------------------

TITLE  
HERITAGE  
SLIM-LINE FLUSH CASEMENT  
Solid Transom Section (Fixed Sash / Sash)

T.Tomicki	E.Krupa	01.06.2012	
Lee Young		17.04.2012	0
DRAWN BY	CHECKED	DATE	ISSUE
DWG NO.	3115		SHT

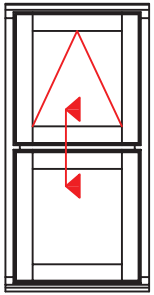
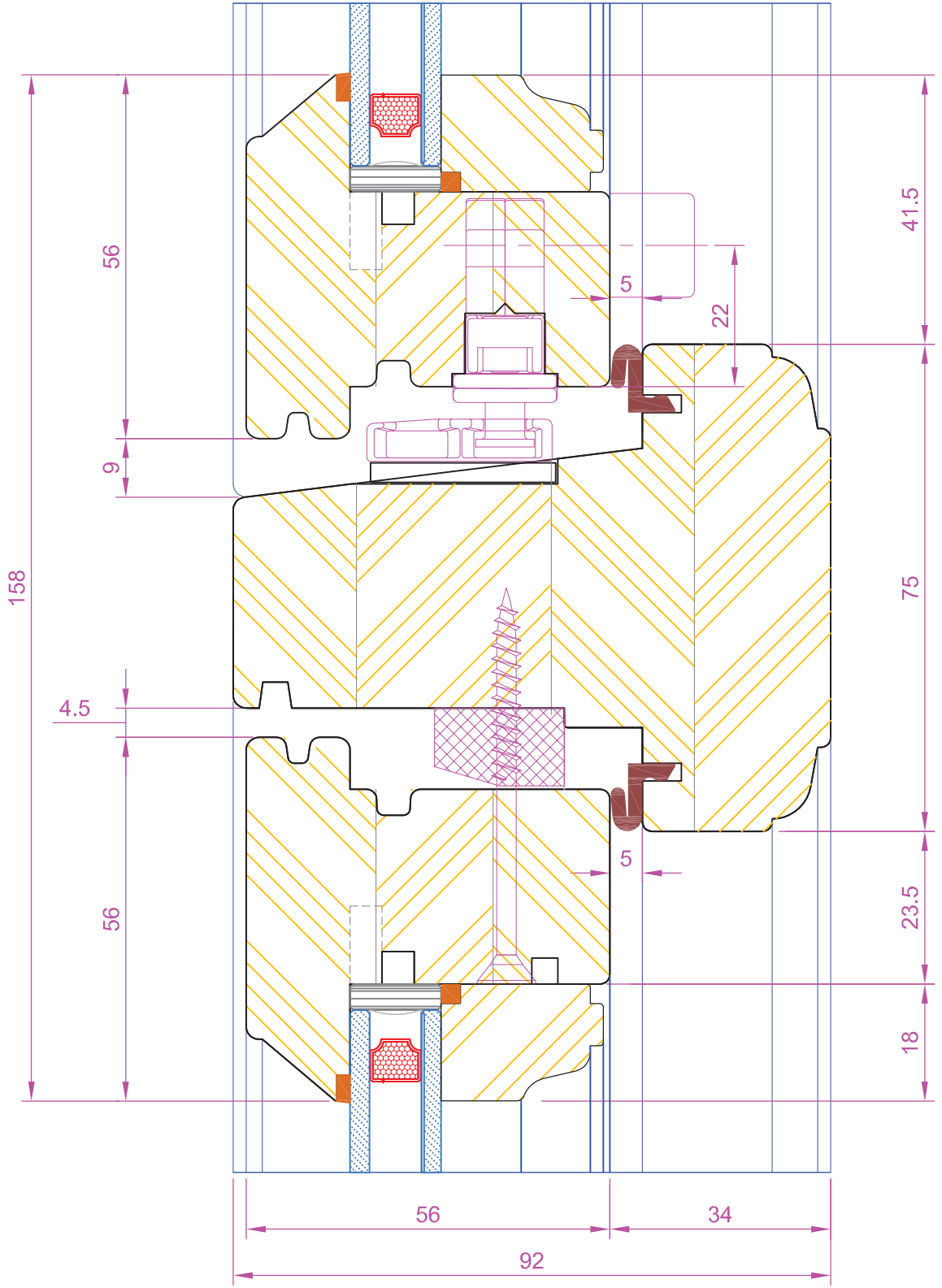

ALL DIMENSIONS IN mm		ORIGINAL PLOT A4 SIZE (210x297)					
SCALE	GENERAL TOLERANCE	MATERIAL					
1 : 1	+ 2	Timber		T.Tomicki	E.Krupa	01.06.2012	
TITLE				Lee Young		17.04.2012	0
HERITAGE				DRAWN BY	CHECKED	DATE	ISSUE
SLIM-LINE FLUSH CASEMENT				DWG NO.			SHT
Solid Transom Section (Sash / Fixed Sash)				3116			1

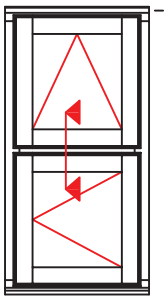
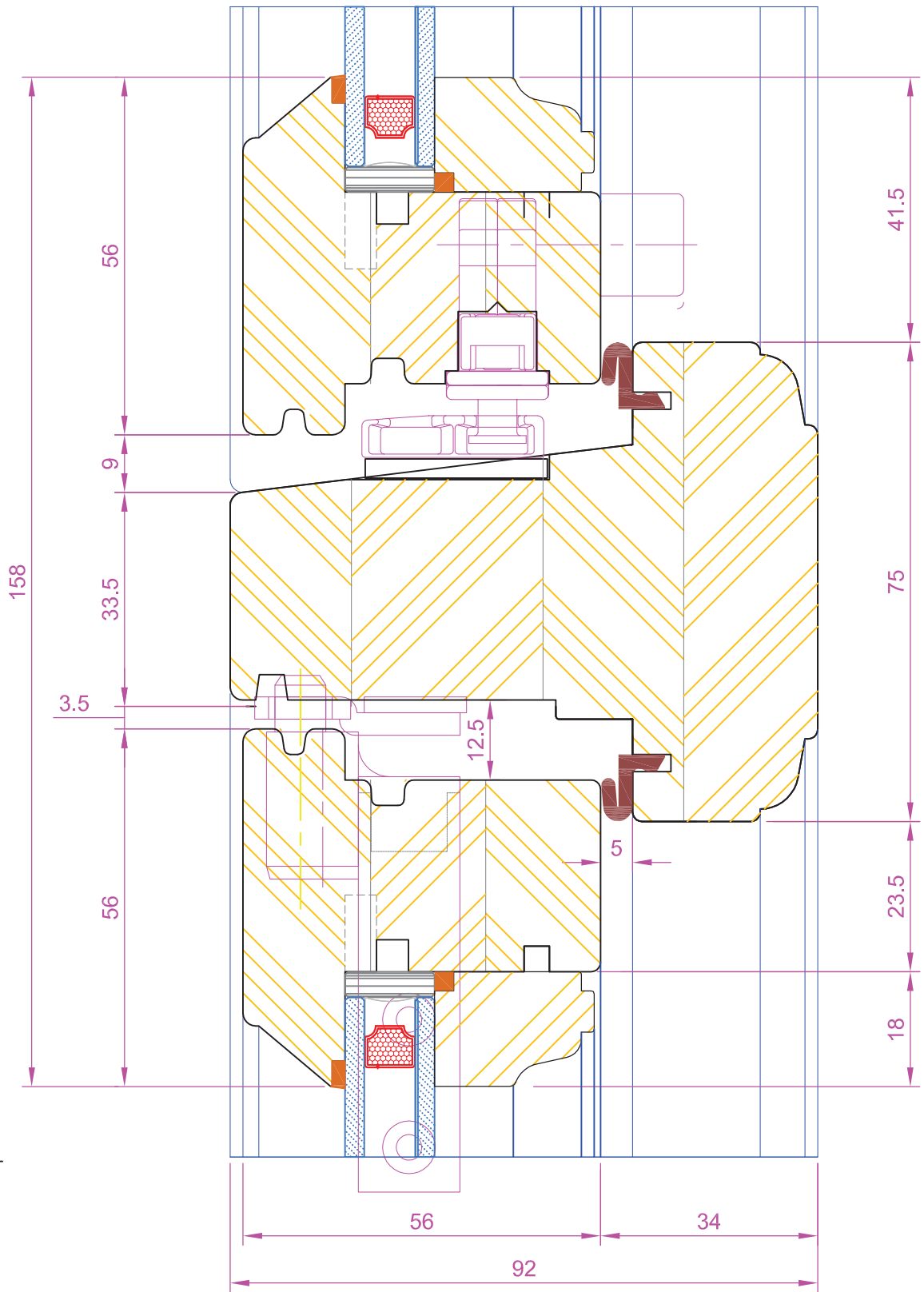

ALL DIMENSIONS IN mm ORIGINAL PLOT A4 SIZE (210x297)

SCALE  
1 : 1

GENERAL  
TOLERANCE  
+ 2

MATERIAL  
Timber

TITLE  
HERITAGE  
SLIM-LINE FLUSH CASEMENT  
Solid Transom Section (Sash / Sash)

T.Tomicki	E.Krupa	01.06.2012	
Lee Young		17.04.2012	0
DRAWN BY	CHECKED	DATE	ISSUE
DWG NO.	3117		SHT

S13 2000

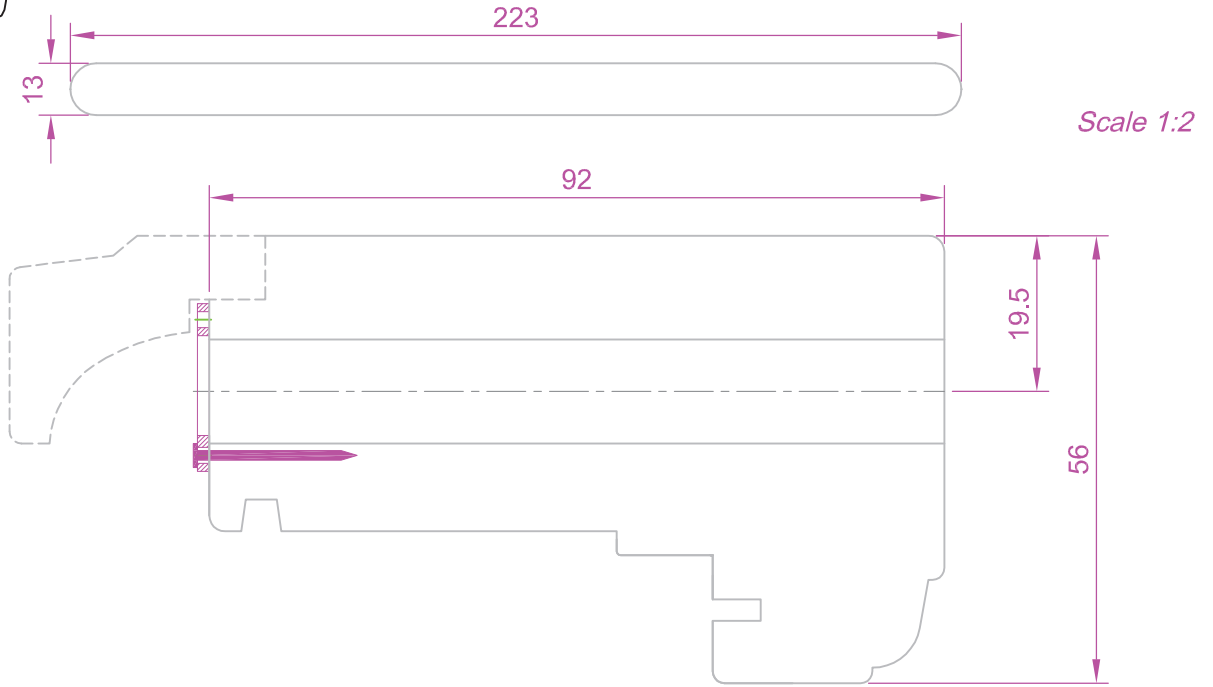

R13 4000

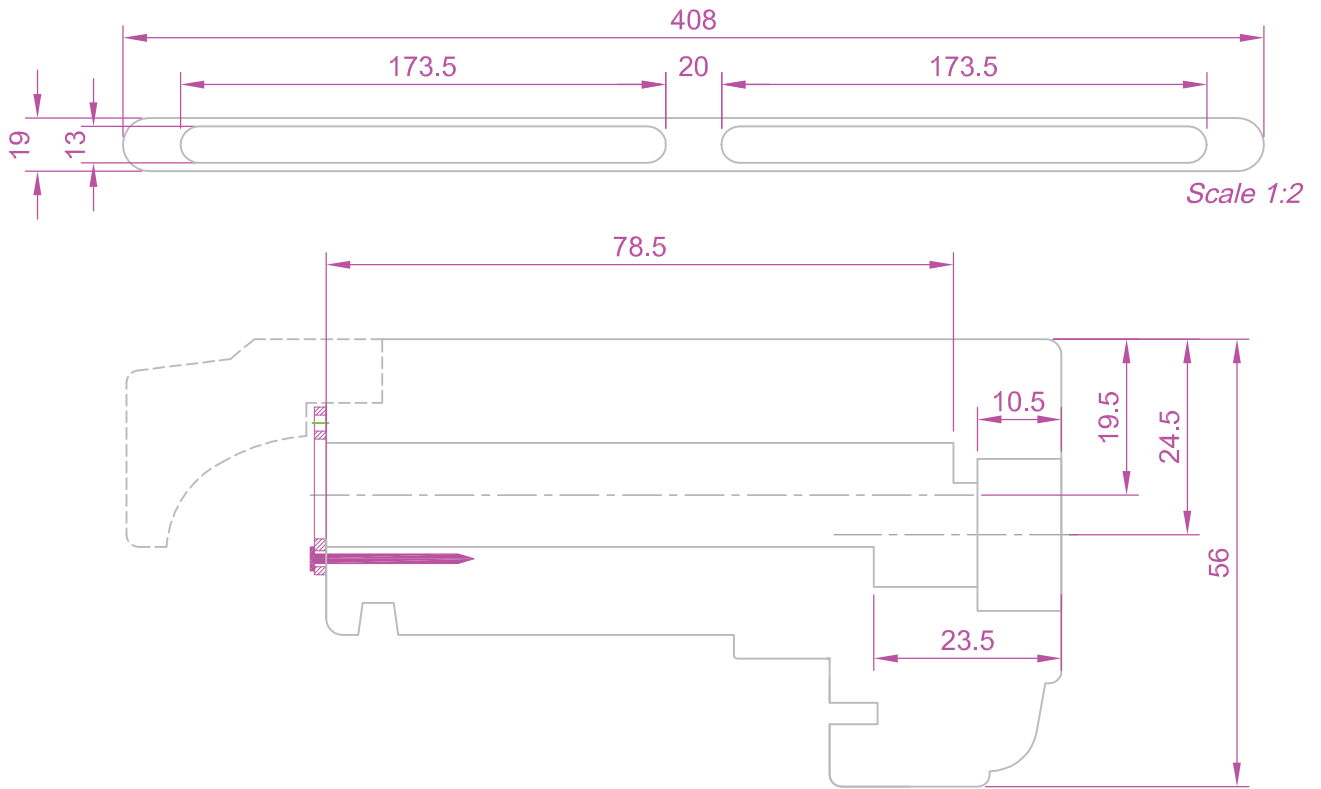

ALL DIMENSIONS IN mm		ORIGINAL PLOT A4 SIZE (210x297)					
SCALE	GENERAL TOLERANCE	MATERIAL					
1 : 1	+ 2	Timber					
TITLE		HERITAGE	DRAWN BY	CHECKED	DATE	ISSUE	
SLIM-LINE FLUSH CASEMENT			DWG NO.	3118	17.04.2012	0	
Head Section Vent Details (If Required)						1	

Section A-A

Section B-B

HEAD DRIP - Included only if vents are required

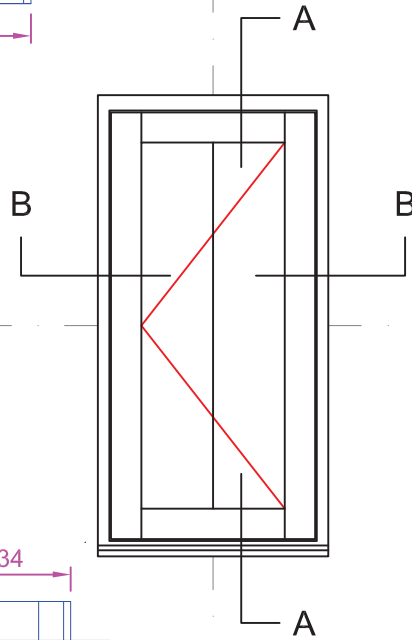
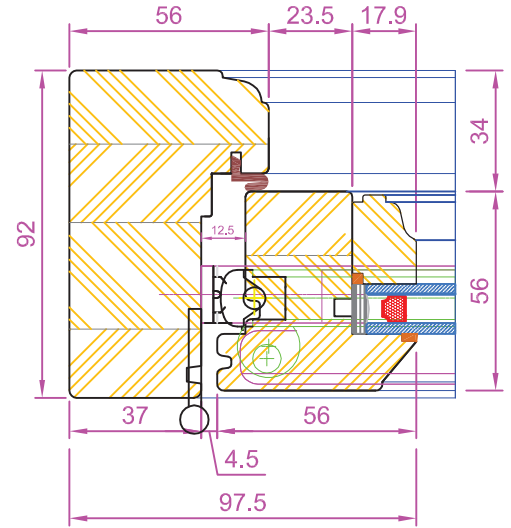
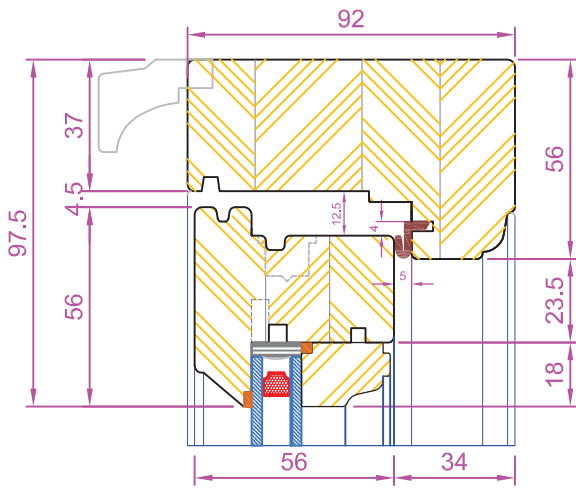

Section A-A

Section B-B

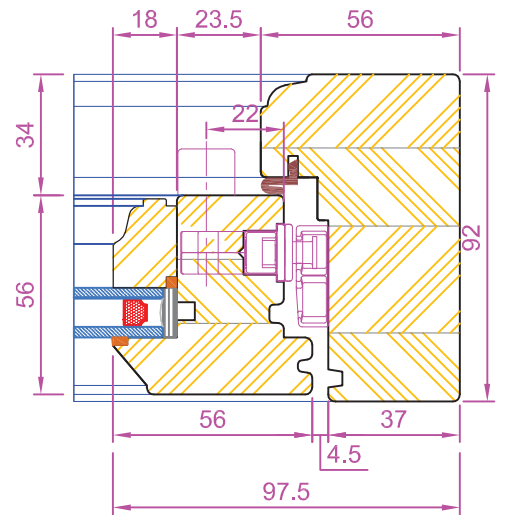
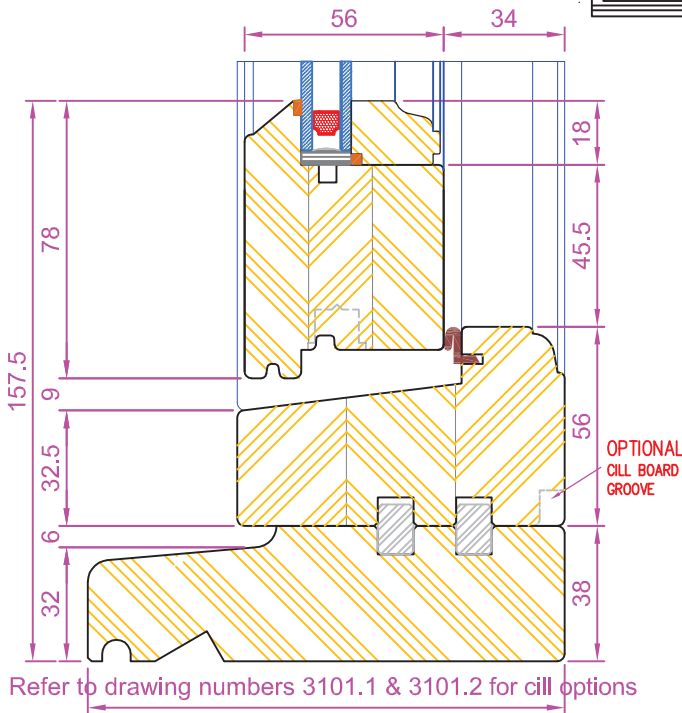

ALL DIMENSIONS IN mm		ORIGINAL PLOT A2 SIZE (420x594)					
SCALE	GENERAL TOLERANCE	MATERIAL		T.Tomicki	E.Krupa	01.06.2012	
1 : 1	+ 2	Timber		L.Young		27.04.2012	0
TITLE		HERITAGE		DRAWN BY	CHECKED	DATE	ISSUE
SLIM-LINE SLIM-LINE FLUSH CASEMENT		Frame & Sash Sections		DWG NO.	3119		SHT
							1