



1 Detail South Connection 2nd floor
SCALE 1:1

PL1	PLANNING CONDITION SUBMISSION 3A-CPW		19.07.2016
C	as clouded	NES	08.06.2016
B	changed descriptions/as clouded	NES	16.03.2016
A	First issue	NES	22.01.2016
Rev	Revision Details	Check	Date

Client:
Almacantar

Contractor:



seele UK Ltd
Unit A33 Jack's Place
6 Corbet Place
London E1 6NN
United Kingdom

Project:
Centre Point London

Title: Head Detail South facade connection 2nd floor H13A Type 116		Revision PL1
--	--	-----------------

Status: For Construction	Date: 22.01.2016	Scale: 1:1 @ A0			
Job No. 658	Drawn by: NES	Checked: GRO			
Origin	CISFB Code	Bldg Code	Level	Series	Code
D801	21	CPW	00	401	A

The information on this drawing is for information only and does not constitute an offer or a contract. It is subject to change without notice.

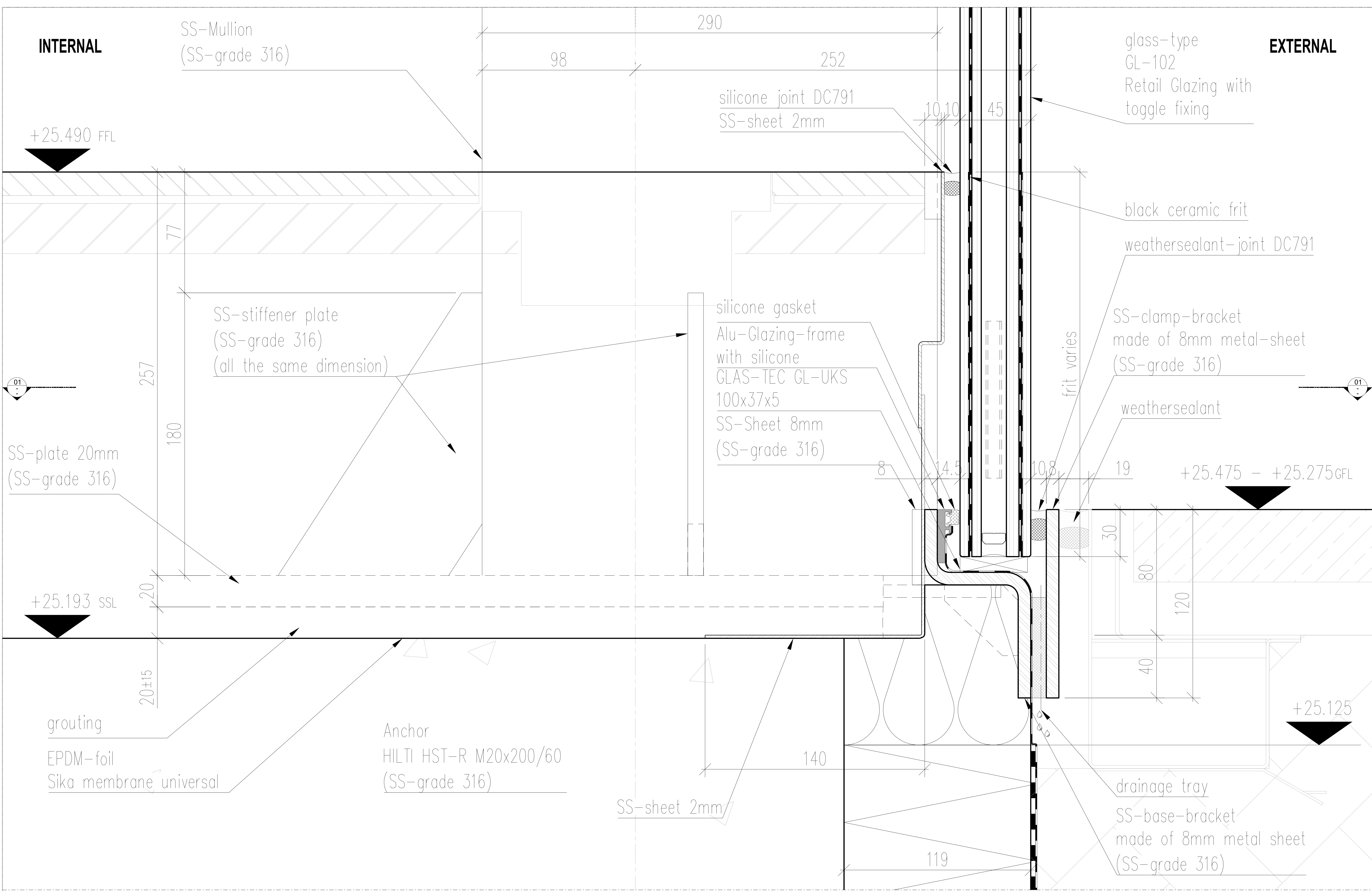

02 Section
CPW_00_403
SCALE 1:1

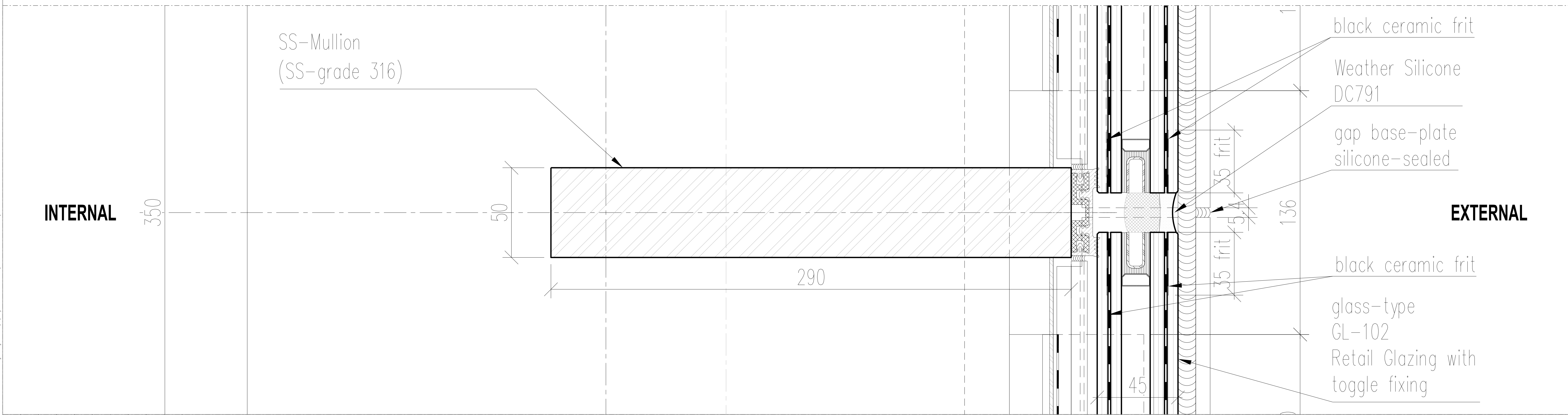

01 Plan
CPW_00_403
SCALE 1:1

PL1	PLANNING CONDITION SUBMISSION 3A-CPW		19.07.2016
B	changed descriptions/as clouded	NES	16.03.2016
A	First issue	NES	22.01.2016
Rev	Revision Details	Check	Date

Client:
Almacantar

Contractor:
Brookfield MULTIPLEX

seele UK Ltd
Unit A33 Jack's Place
6 Corbet Place
London E1 6NN
United Kingdom

seele

Project:
Centre Point London

Title:
**Floor-Detail South facade
H13A Type 116**

Status: For Construction	Date: 22.01.2016	Scale: 1:1 @ A0			
Job No. 658	Drawn by: NES	Checked: GRO			
Origin	CISFB Code	Bldg Code	Level	Series	Code
D801	21	CPW	00	403	B

Revision
PL1

The information on this drawing is the property of the design team and is not to be used or reproduced in any form without the written consent of the design team.

03 Elevation
CPW_00_405
SCALE 1:1

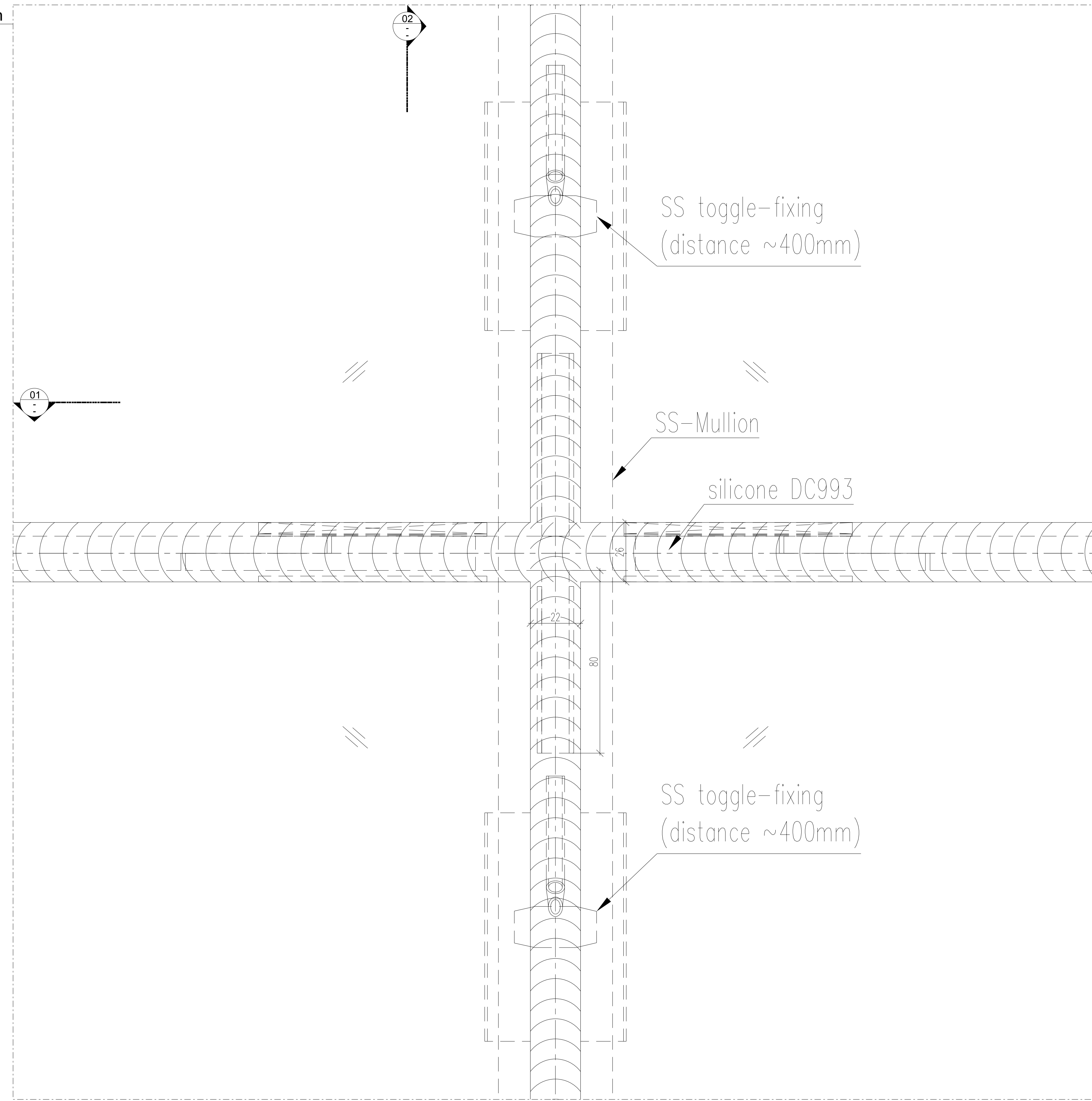

02 Section
CPW_00_405
SCALE 1:1

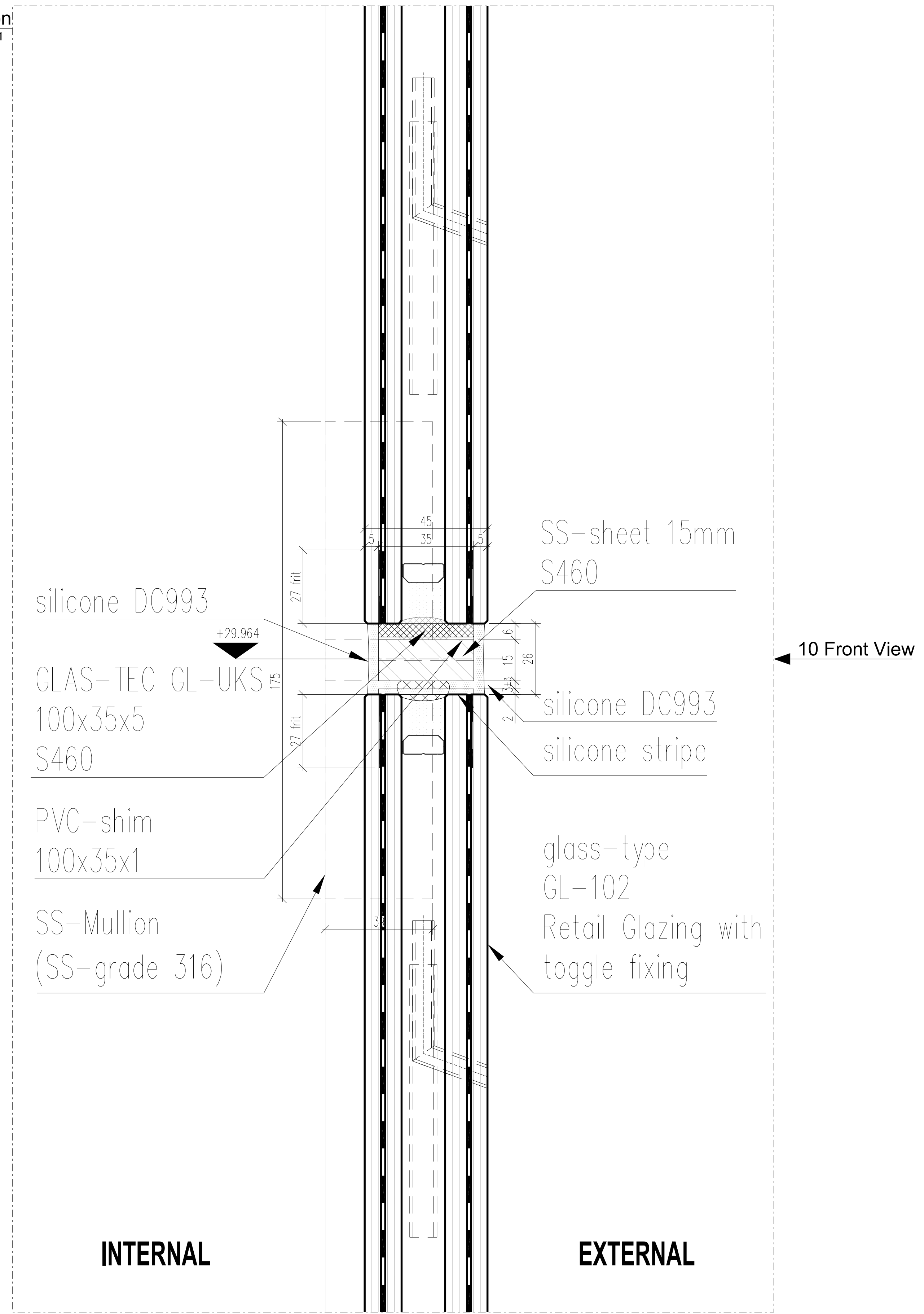

01 Plan
CPW_00_405
SCALE 1:1

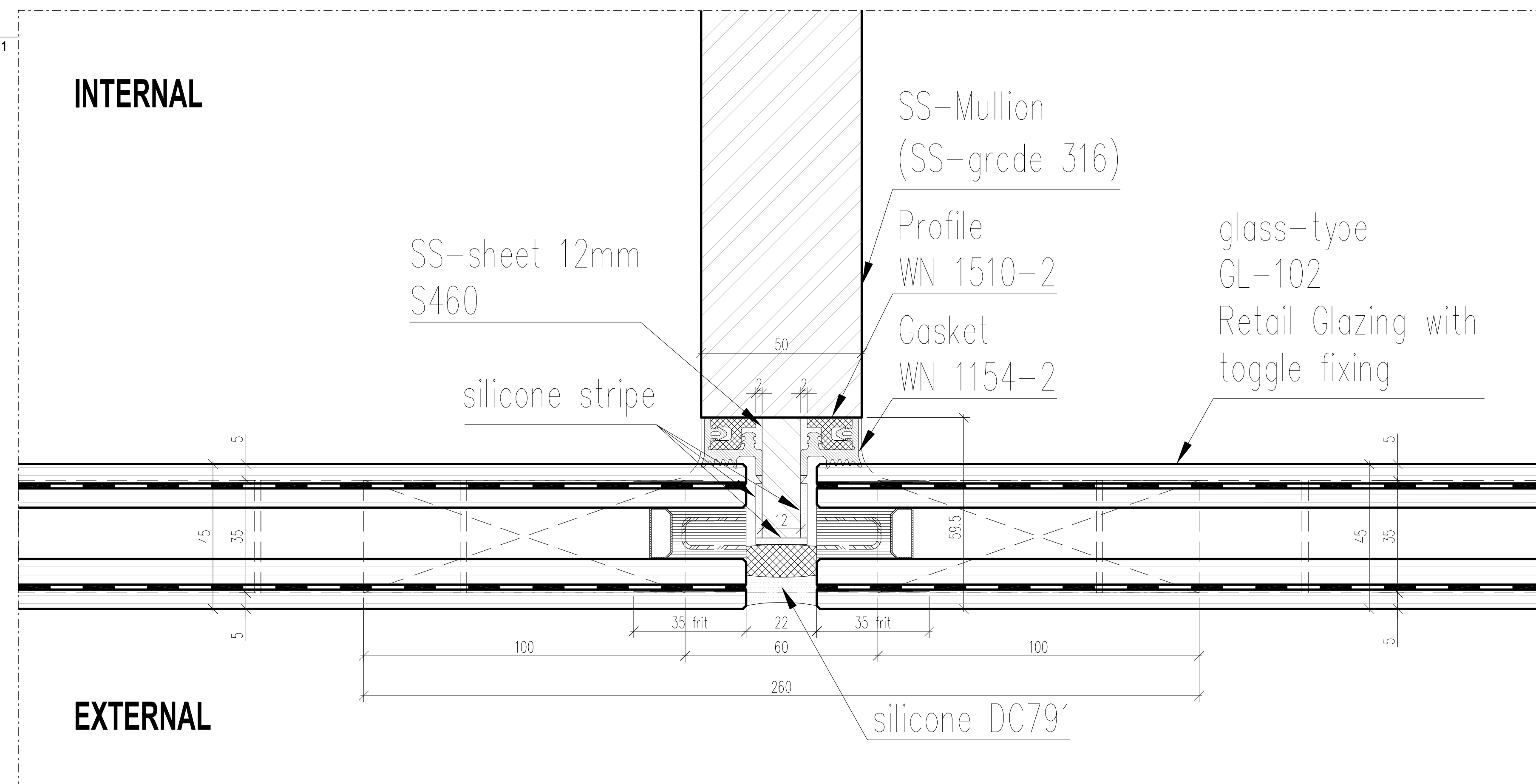

PL1	PLANNING CONDITION SUBMISSION 3A-CPW		19.07.2016
C	as clouded	NES	-
B	changed description/as clouded	NES	16.03.2016
A	First issue	NES	22.01.2016
Rev	Revision Details	Check	Date

Client:
Almacantar

Contractor:
Brookfield MULTIPLEX

seele UK Ltd
Unit A33 Jack's Place
6 Corbet Place
London E1 6NN
United Kingdom

seele

Project:
Centre Point London

Title:
Glass-support South East facade
H13A Type 116

Revision
PL1

Status: For Construction	Date: 22.01.2016	Scale: 1:1 @ A0			
Job No. 658	Drawn by: NES	Checked: GRO			
Origin	CISFB Code	Bldg Code	Level	Series	Code
D801	21	CPW	00	405	C

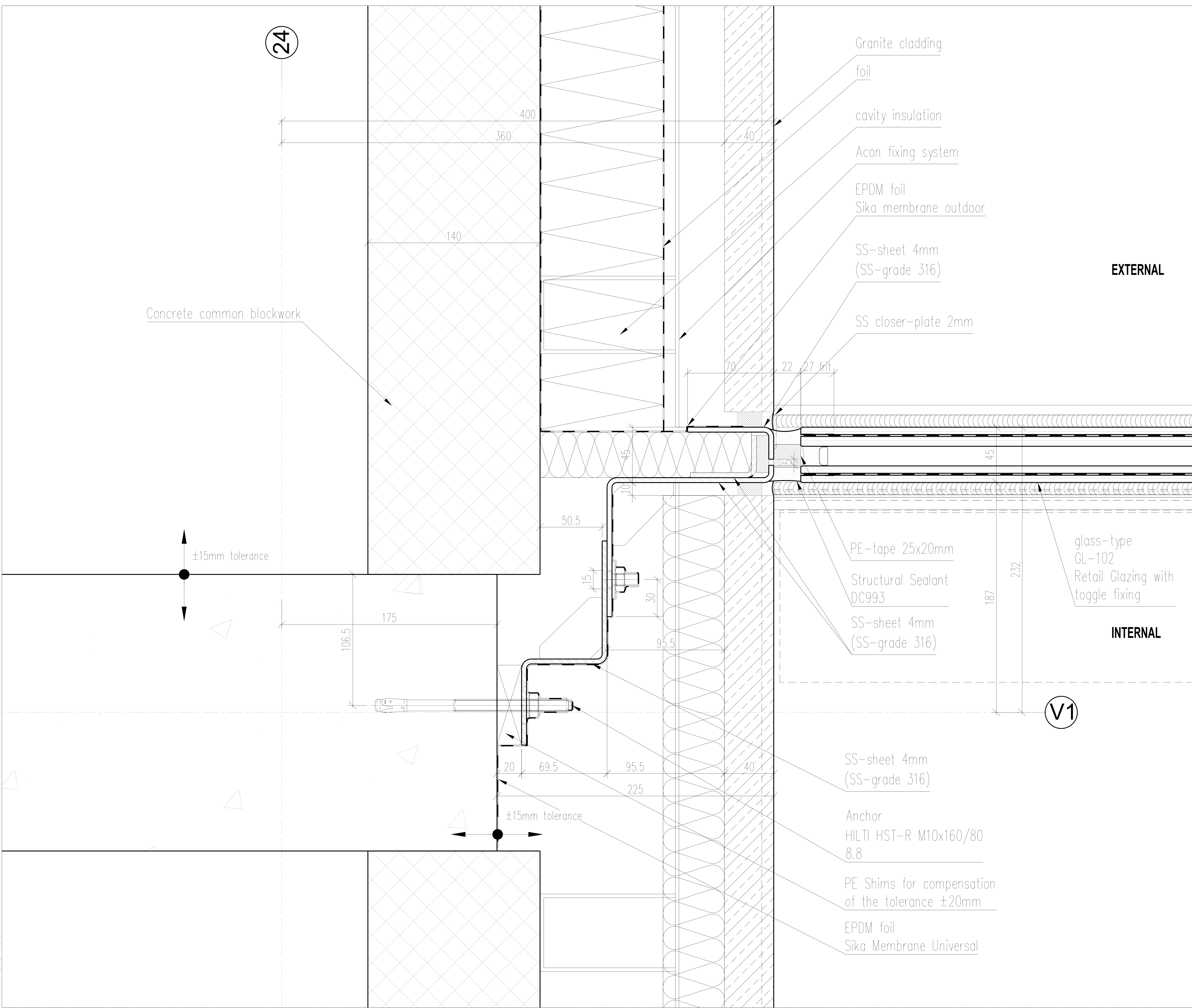

24

EXTERNAL

INTERNAL

V1

Concrete common blockwork

Granite cladding

foil

cavity insulation

Acon fixing system

EPDM foil

Sika membrane outdoor

SS-sheet 4mm
(SS-grade 316)

SS closer-plate 2mm

PE-tape 25x20mm

Structural Sealant
DC993

SS-sheet 4mm
(SS-grade 316)

SS-sheet 4mm
(SS-grade 316)

Anchor
HILTI HST-R M10x160/80
8.8

PE Shims for compensation
of the tolerance ±20mm

EPDM foil
Sika Membrane Universal

glass-type
GL-102
Retail Glazing with
toggle fixing

±15mm tolerance

±15mm tolerance

01 Detail - Lateral interface
SCALE 1:1

PL1	PLANNING CONDITION SUBMISSION 3A-CPW		19.07.2016
C	as clouded	NES	08.06.2016
B	changed descriptions/as clouded	NES	16.03.2016
A	First issue	NES	22.01.2016
Rev	Revision Details	Check	Date

Client:
Almacantar

Contractor:
Brookfield MULTIPLEX

seele UK Ltd
Unit A33 Jack's Place
6 Corbet Place
London E1 6NN
United Kingdom

seele

Project:
Centre Point London

Title:
Connecting East facade to granite
H13A Type 116

Revision
PL1

Status: For Construction	Date: 22.01.2016	Scale: 1:1 @ A0			
Job No. 658	Drawn by: NES	Checked: GRO			
Origin	CISFB Code	Bldg Code	Level	Series	Code
D801	21	CPW	00	407	D

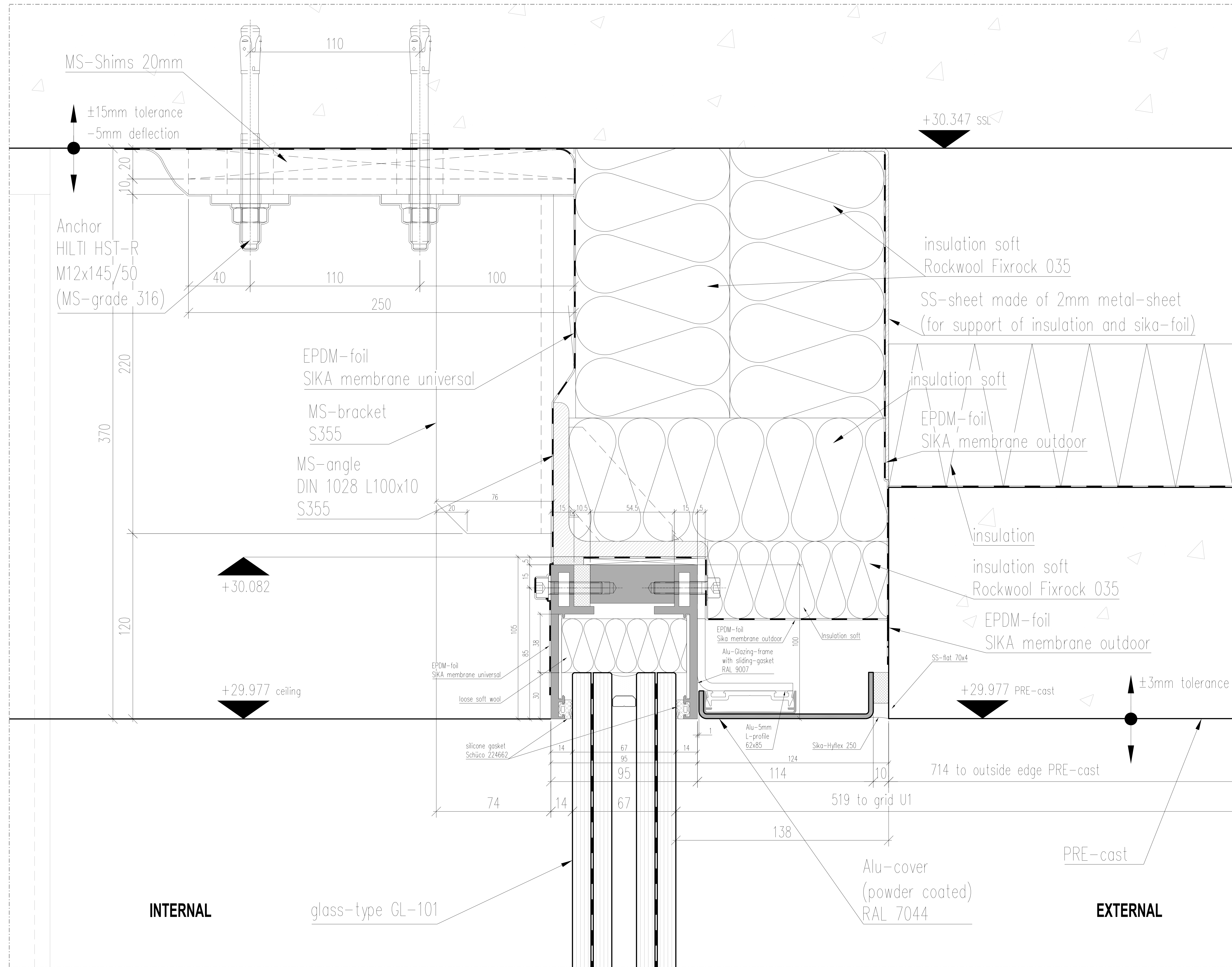

PL1	PLANNING CONDITION SUBMISSION 3A-CPW		19.07.2016
C	as clouded	NES	-
B	as clouded	NES	22.04.2016
A	first issue	NES	05.02.2016
Rev	Revision Details	Check	Date

Client:
Almacantar

Contractor:
Brookfield MULTIPLEX

seele UK Ltd
Unit A33 Jack's Place
6 Corbet Place
London E1 6NN
United Kingdom

seele

Project:
Centre Point London

Title:
Head Detail South West facade to Grid W2
and 25
H13A Type 115A

Revision
PL1

Status: For Construction	Date: 03.02.2016	Scale: 1:1 @ A0			
Job No. 658	Drawn by: NES/STT	Checked: GRO			
Origin	CISFB Code	Bldg Code	Level	Series	Code
D801	21	CPW	00	452	E

01 Detail South West Connection
SCALE 1:1

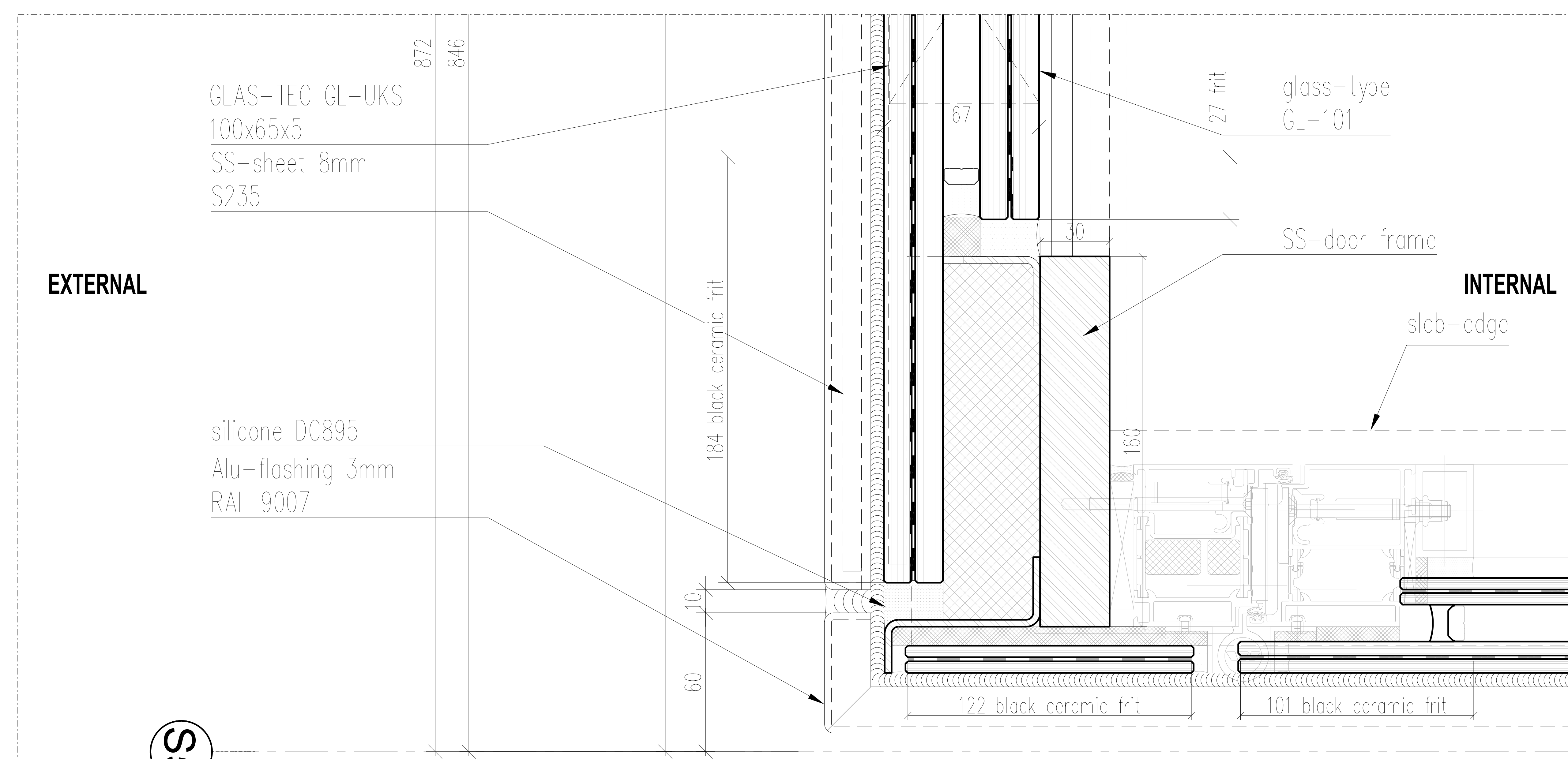
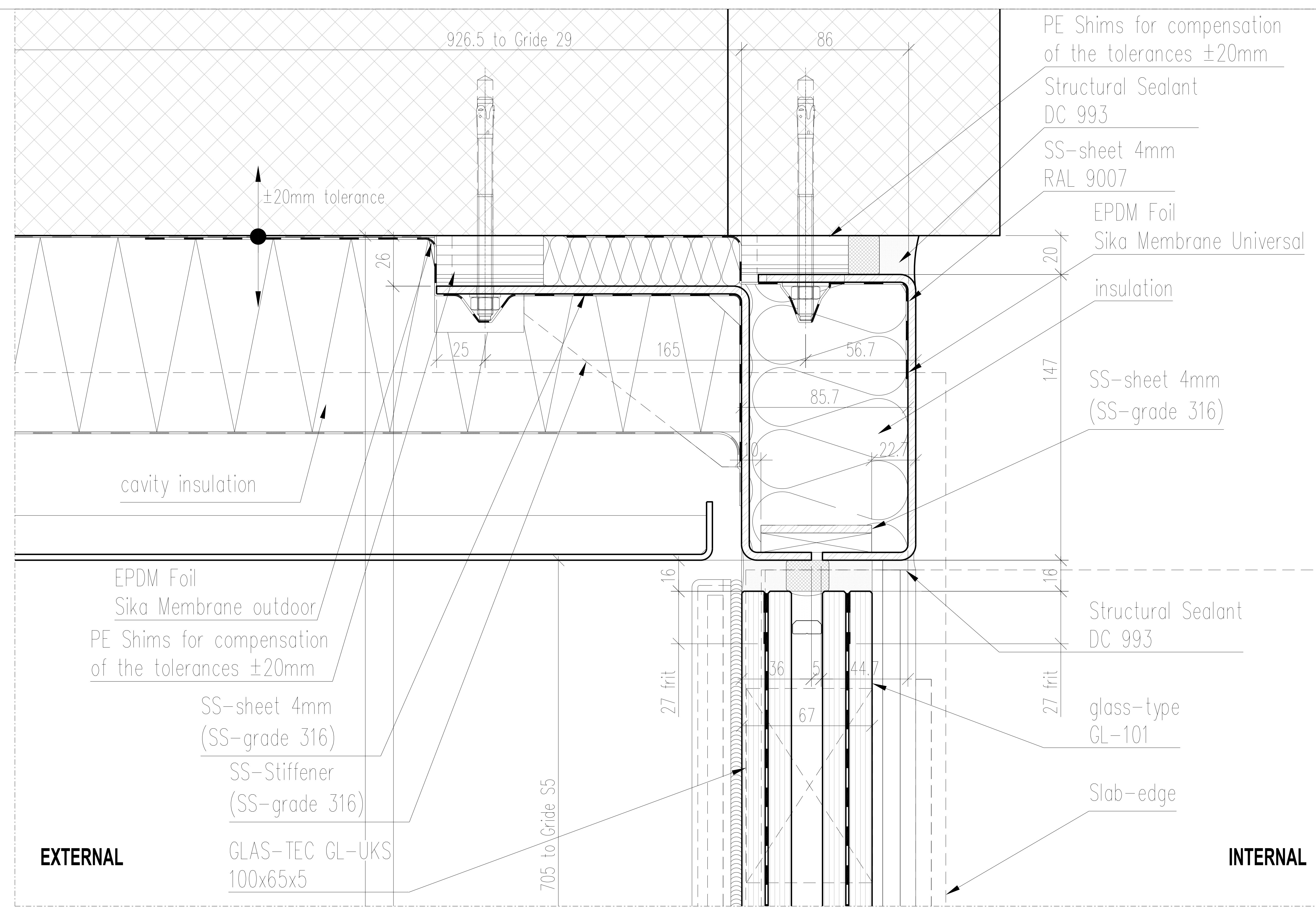

PL1	PLANNING CONDITION SUBMISSION 3A-CPW		19.07.2016
C	as clouded	NES	-
B	changed description/as clouded	NES	22.04.2016
A	First issue	GRO	05.02.2016
Rev	Revision Details	Check	Date

Client:
Almacantar

Contractor:
Brookfield MULTIPLEX

seele UK Ltd
Unit A33 Jack's Place
6 Corbet Place
London E1 6NN
United Kingdom

Project:
Centre Point London

Title:
Connecting North West facade to concrete
H13A Type 115A

Status: For Construction	Date: 03.02.2016	Scale: 1:1 @ A0			
Job No. 658	Drawn by: NES/STT	Checked: GRO			
Origin	CISFB Code	Bldg Code	Level	Series	Code
D801	21	CPW	00	454	F

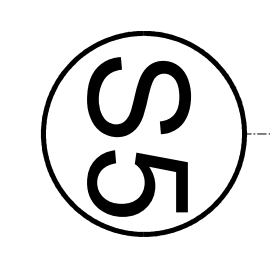

PL1	PLANNING CONDITION SUBMISSION 3A-CPW		19.07.2016
B	as clouded	NES	-
A	First issue	NES	22.04.2016
Rev	Revision Details	Check	Date

Client: Almacantar					
Contractor: Brookfield MULTIPLEX					
seele UK Ltd Unit A33 Jack's Place 6 Corbet Place London E1 6NN United Kingdom					
Project: Centre Point London					
Title: Head and Bottom Detail North facade H13A	Revision PL1				
Status: For Construction	Date: 03.03.2016 Scale: 1:1 @ A0				
Job No. 658	Drawn by: NES/HAN Checked: GRO				
Origin	CISFB Code	Bldg Code	Level	Series	Code
D801	21	CPW	00	461	G

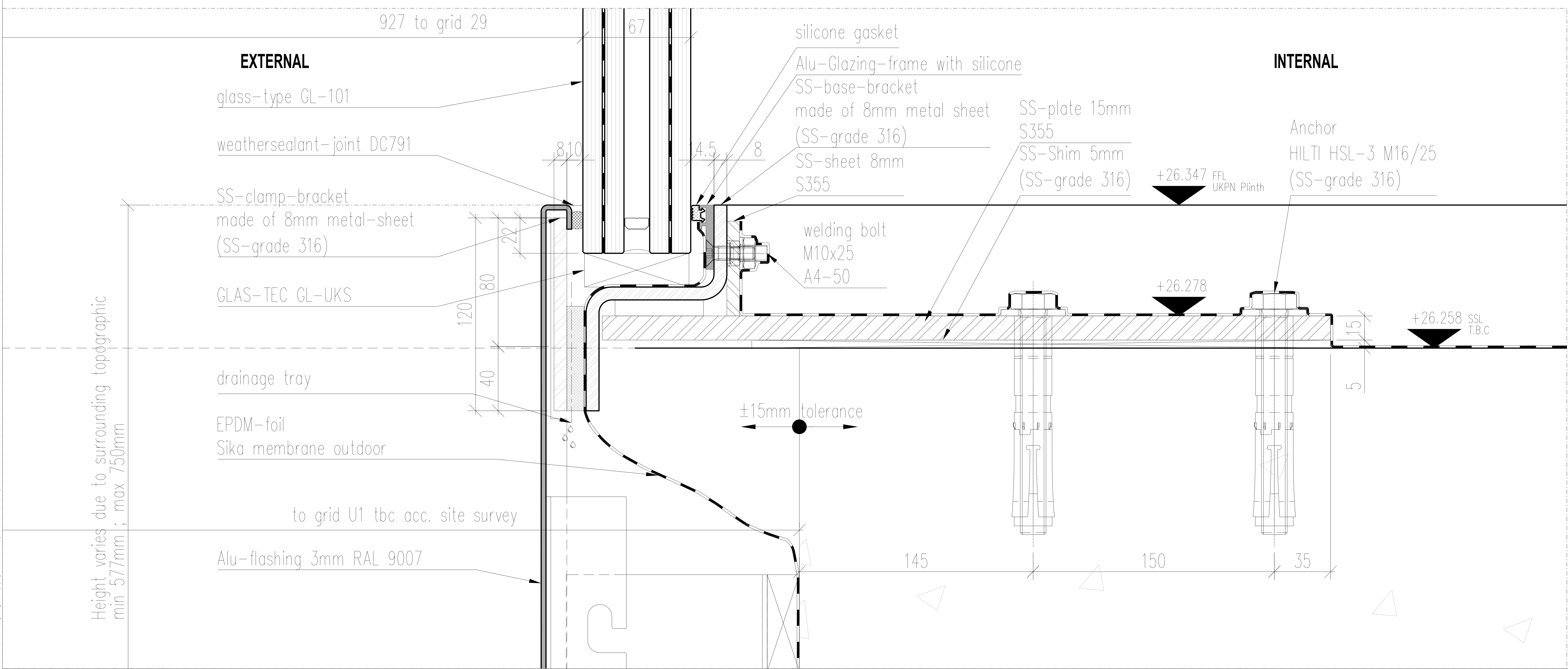
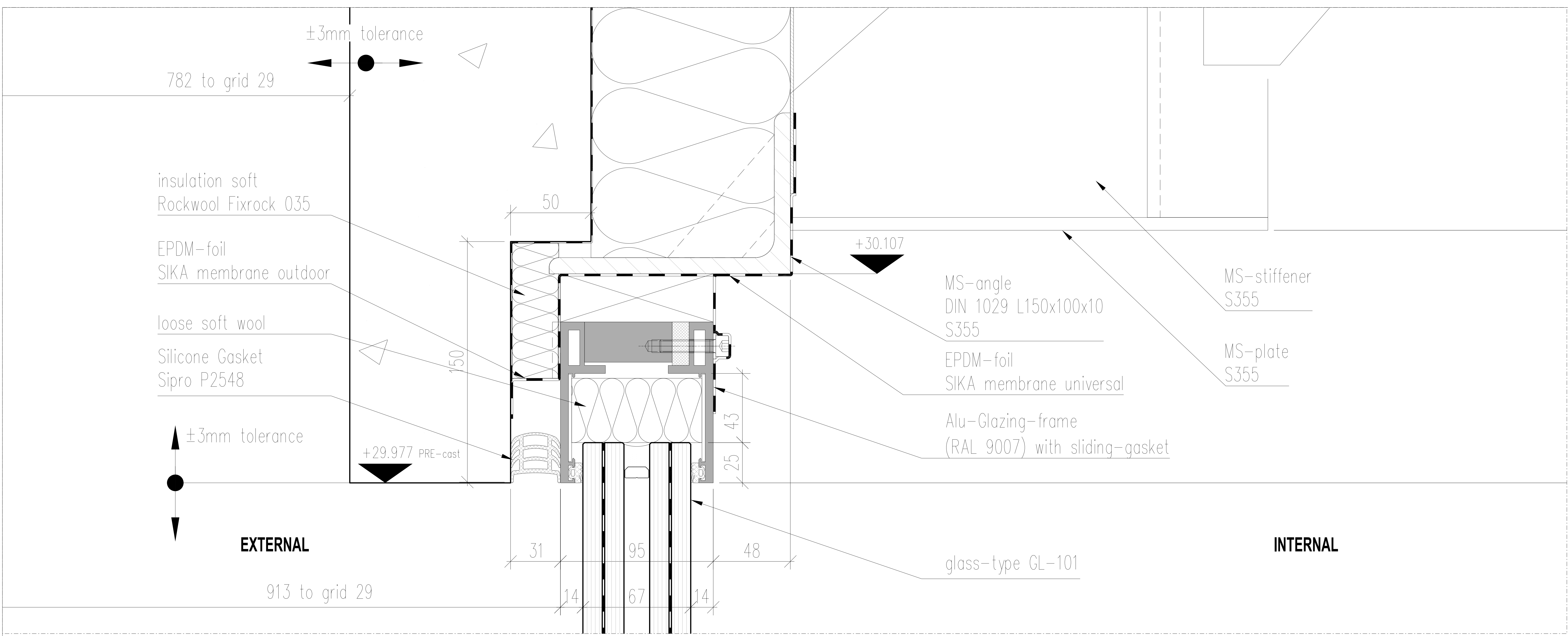

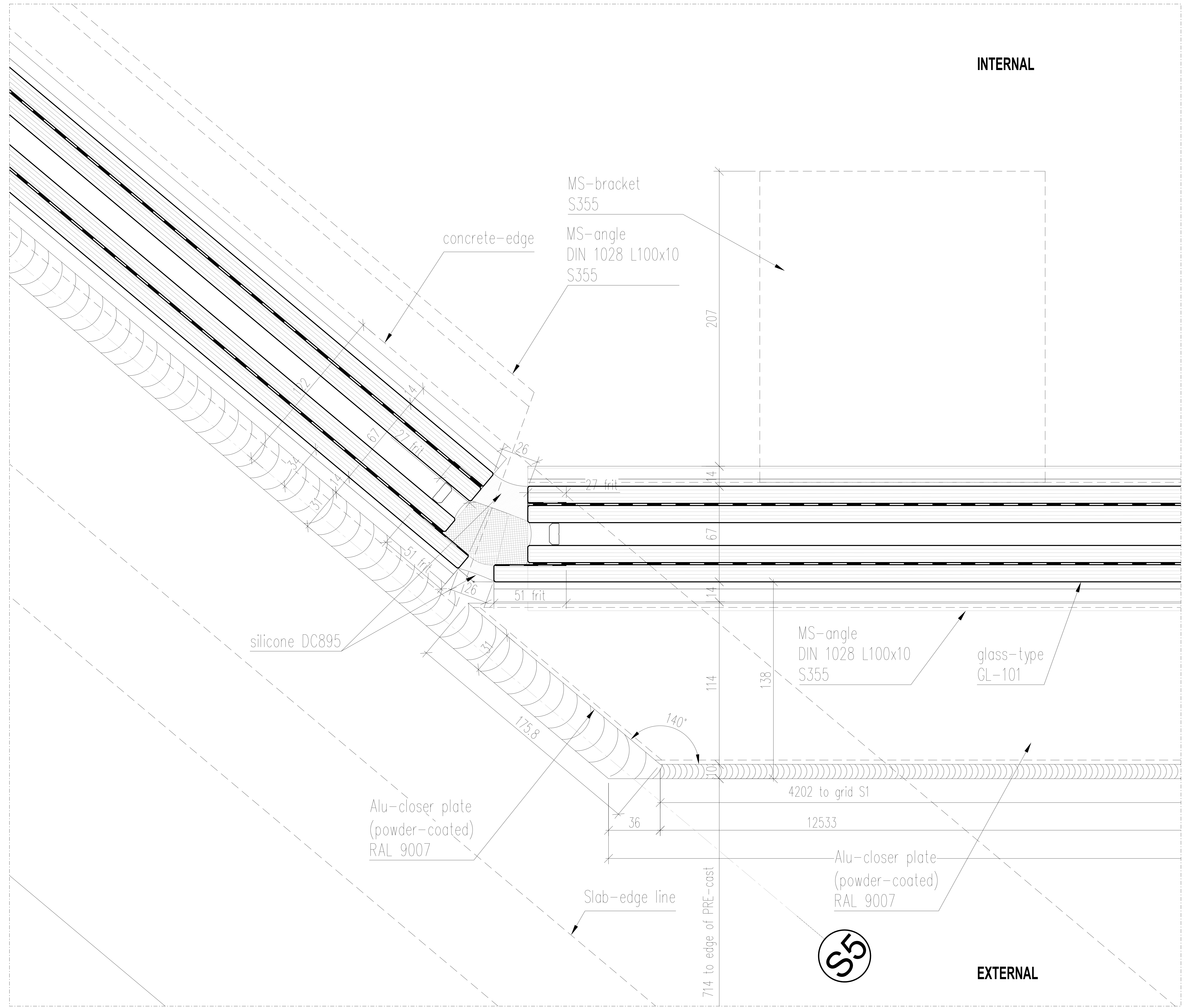

The information on this drawing is for information only and does not constitute a contract. The contractor shall be responsible for checking the accuracy of the information on this drawing and for ensuring that it is up-to-date and correct. The contractor shall be responsible for ensuring that the information on this drawing is used in accordance with its intended purpose.



01 Detail
CPW_00_112
SCALE 1:1

PL1	PLANNING CONDITION SUBMISSION 3A-CPW		19.07.2016
B	as clouded	NES	-
A	First issue	GRO	05.02.2016
Rev	Revision Details	Check	Date

Client:
Almacantar

Contractor:



seele UK Ltd
 Unit A33 Jack's Place
 6 Corbet Place
 London E1 6NN
 United Kingdom

Project:
Centre Point London

Title: Reflection ceiling Sout West facade H13A Type 115A		Revision PL1
---	--	-----------------

Status: For Construction	Date: 08.03.2016	Scale: 1:1 @ A0			
Job No. 658	Drawn by: NES/STT	Checked: GRO			
Origin	CISFB Code	Bldg Code	Level	Series	Code
D801	21	CPW	00	462	H

The information on this drawing is for information only and does not constitute an offer or a contract. The information is subject to change without notice. The information is provided as is and without any warranty.