

ALL DIMENSIONS IN mm		ORIGINAL PLOT A4 SIZE (210x297)					
SCALE	GENERAL TOLERANCE	MATERIAL					
1 : 1	+ 2	Timber		S. Felczak	J. Stebelski	13.01.2011	
				E.Pech		06.08.2007	0
TITLE	LIPPED CASEMENT Sections Cill Extension			DRAWN BY	CHECKED	DATE	ISSUE
				DWG NO.	0101		SHT 1

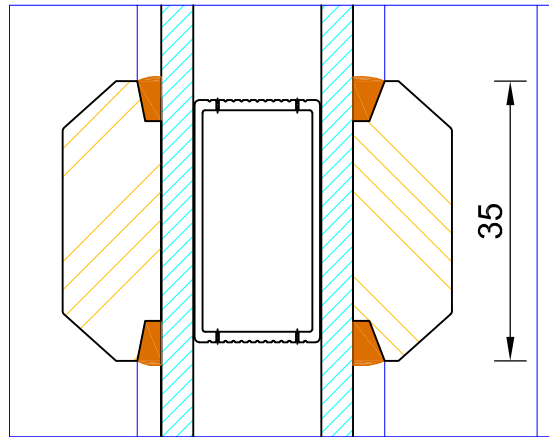

60 (varies min 60 / max 110mm)

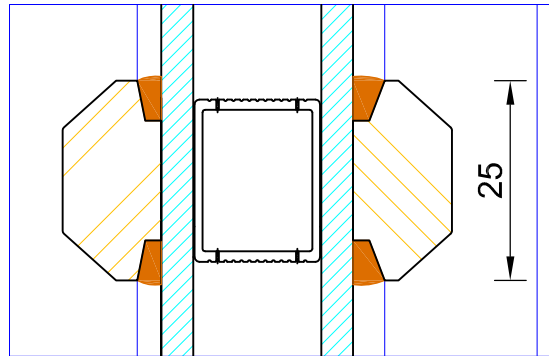
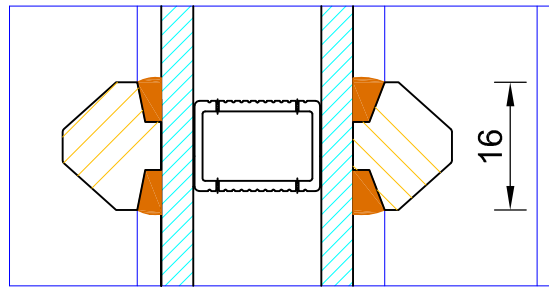
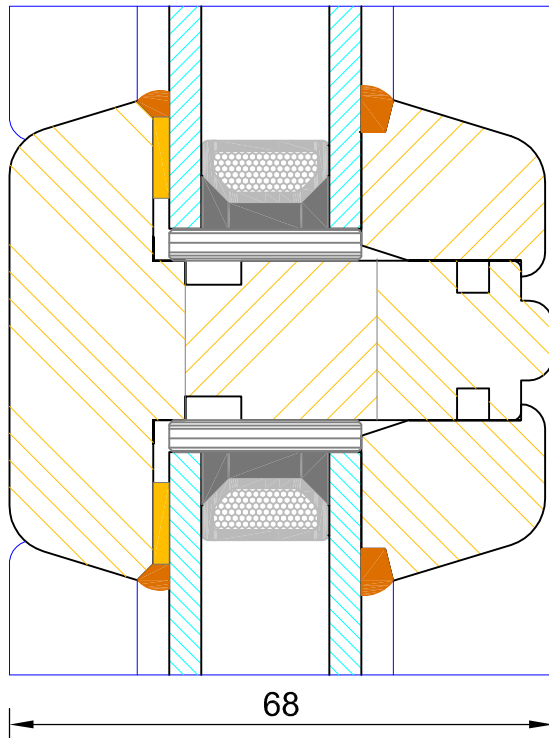

ALL DIMENSIONS IN mm		ORIGINAL PLOT A4 SIZE (210x297)		C. Young	04.03.2014	
SCALE	GENERAL TOLERANCE	MATERIAL		L. Young	16.08.2012	
1 : 1	+ 2	Timber		S. Felczak	13.01.2011	
				E.Pech	06.08.2007	0
TITLE			LIPPED CASEMENT	DRAWN BY	CHECKED	DATE
			Section Solid Bar / Stick-on-bar	DWG NO.	0102	ISSUE
						SHT
						1

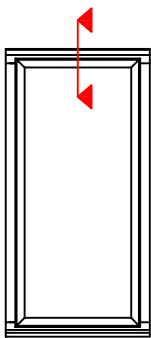
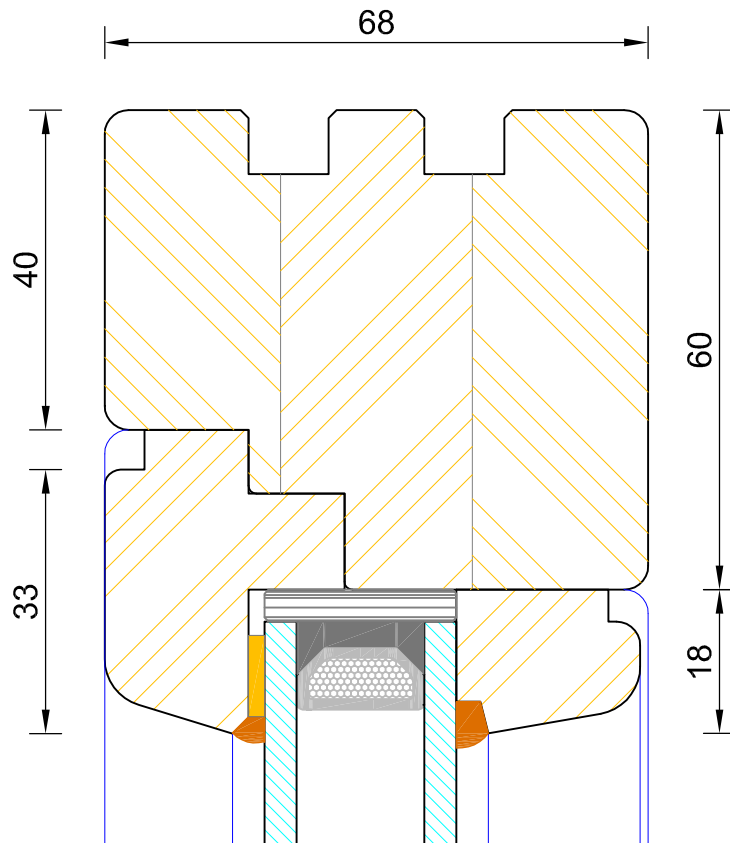

	ALL DIMENSIONS IN mm		ORIGINAL PLOT A4 SIZE (210x297)					
	SCALE	GENERAL TOLERANCE	MATERIAL					
	1 : 1	+ 2	Timber	S. Felczak	J. Stebelski	13.01.2011		
				E.Pech		06.08.2007	0	
TITLE			LIPPED CASEMENT Head Section Fixed Light		DRAWN BY	CHECKED	DATE	ISSUE
					DWG NO.	0103.1		SHT 1

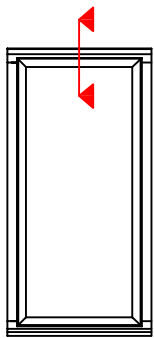
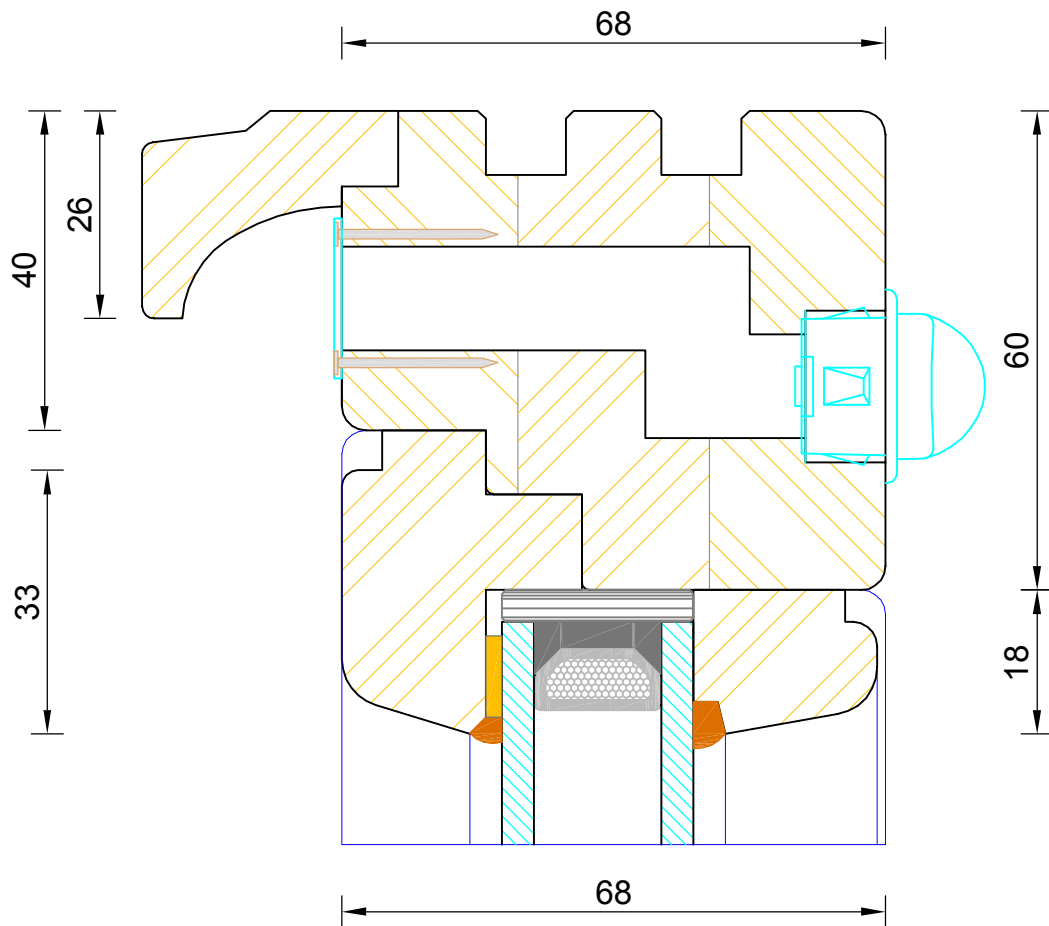

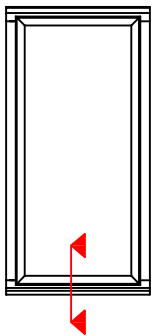
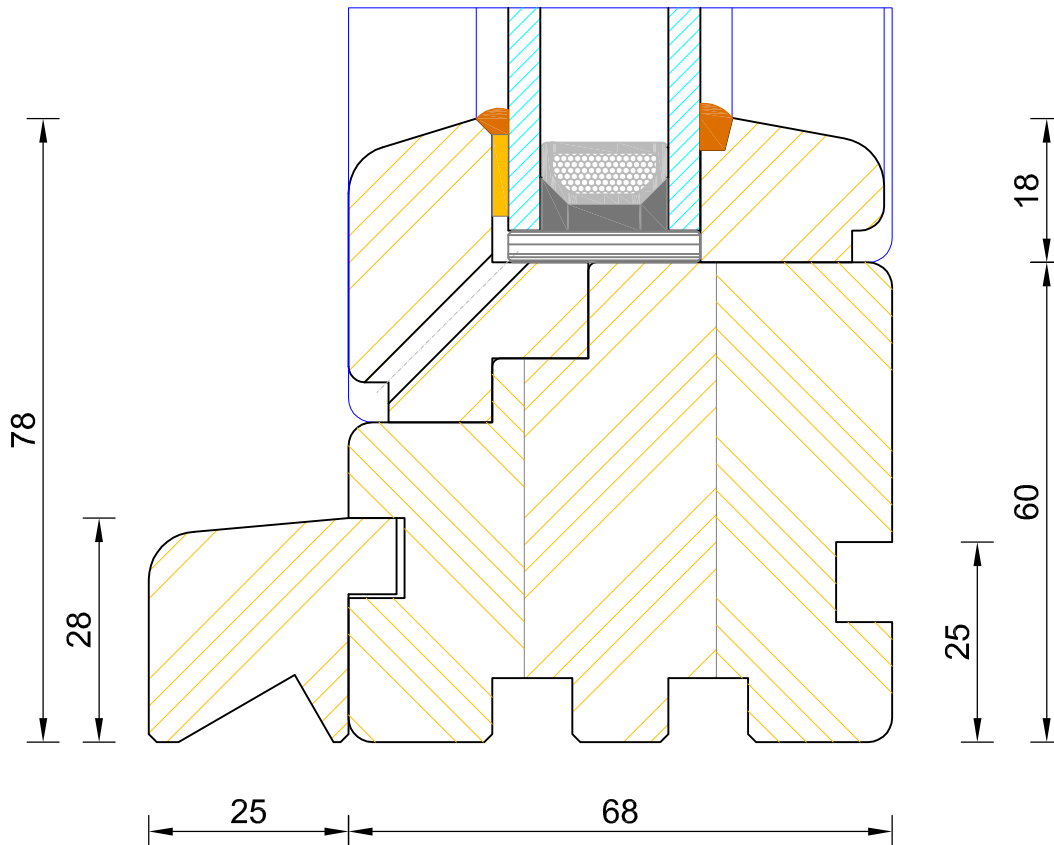



CILL EXTENSION - available options:

25mm (93mm o/a) / 47mm (115mm o/a) / 62mm (130mm o/a) /
 87mm (155mm o/a) / 100mm (168mm o/a) / 114mm (182mm o/a) /
 125mm (193mm o/a) / 140mm (208mm o/a)

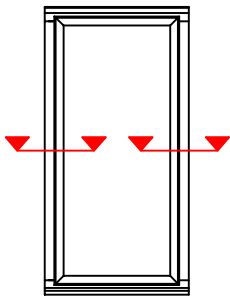
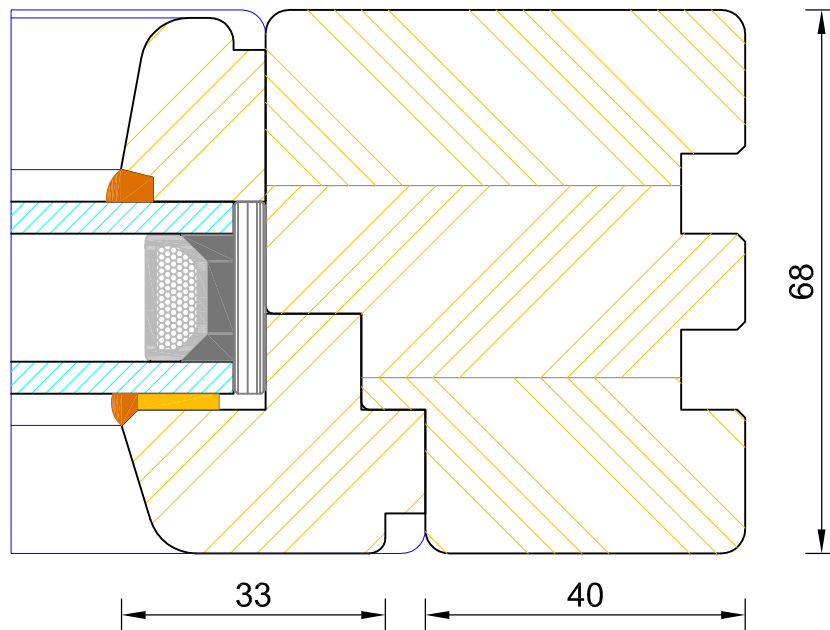
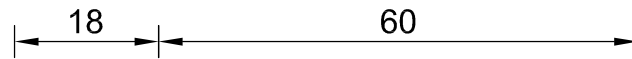
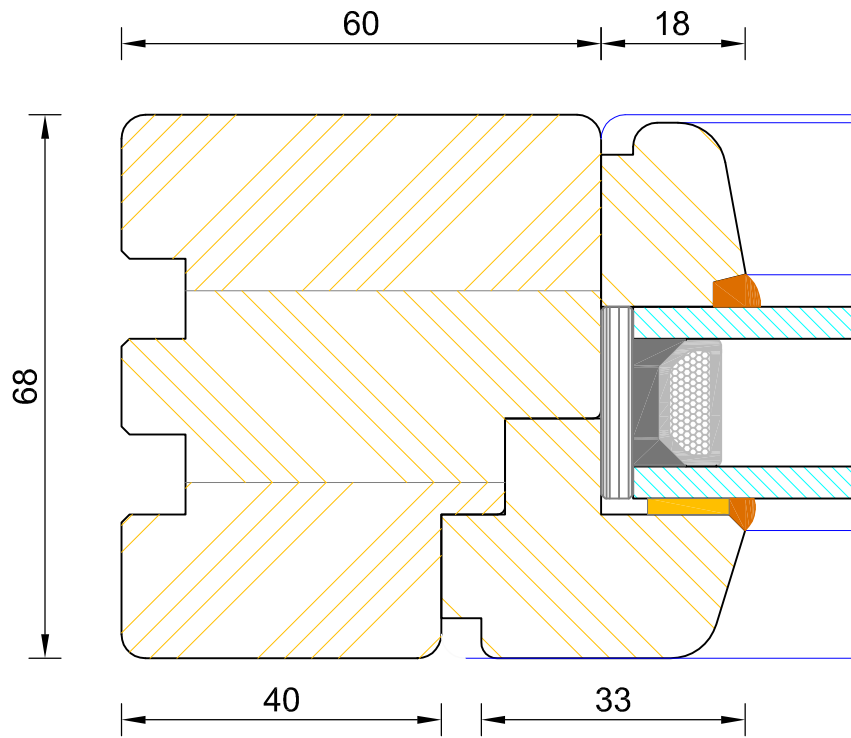

ALL DIMENSIONS IN mm		ORIGINAL PLOT A4 SIZE (210x297)					
SCALE	GENERAL TOLERANCE	MATERIAL					
1 : 1	+ 2	Timber		S. Felczak	J. Stebelski	13.01.2011	
TITLE				E.Pech		06.08.2007	0
				LIPPED CASEMENT Cill Section Fixed Light		DRAWN BY	CHECKED
				DWG NO.		0104	SHT 1



 Bereco DELIVERING THE DIFFERENCE	ALL DIMENSIONS IN mm		ORIGINAL PLOT A4 SIZE (210x297)					
	SCALE	GENERAL TOLERANCE	MATERIAL					
	1 : 1	+ 2	Timber		S. Felczak	J. Stebelski	13.01.2011	
	TITLE		LIPPED CASEMENT Jamb Sections Fixed Light		E.Pech		06.08.2007	0
				DRAWN BY	CHECKED	DATE	ISSUE	
				DWG NO.		0105	SHT	1

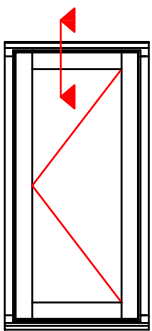
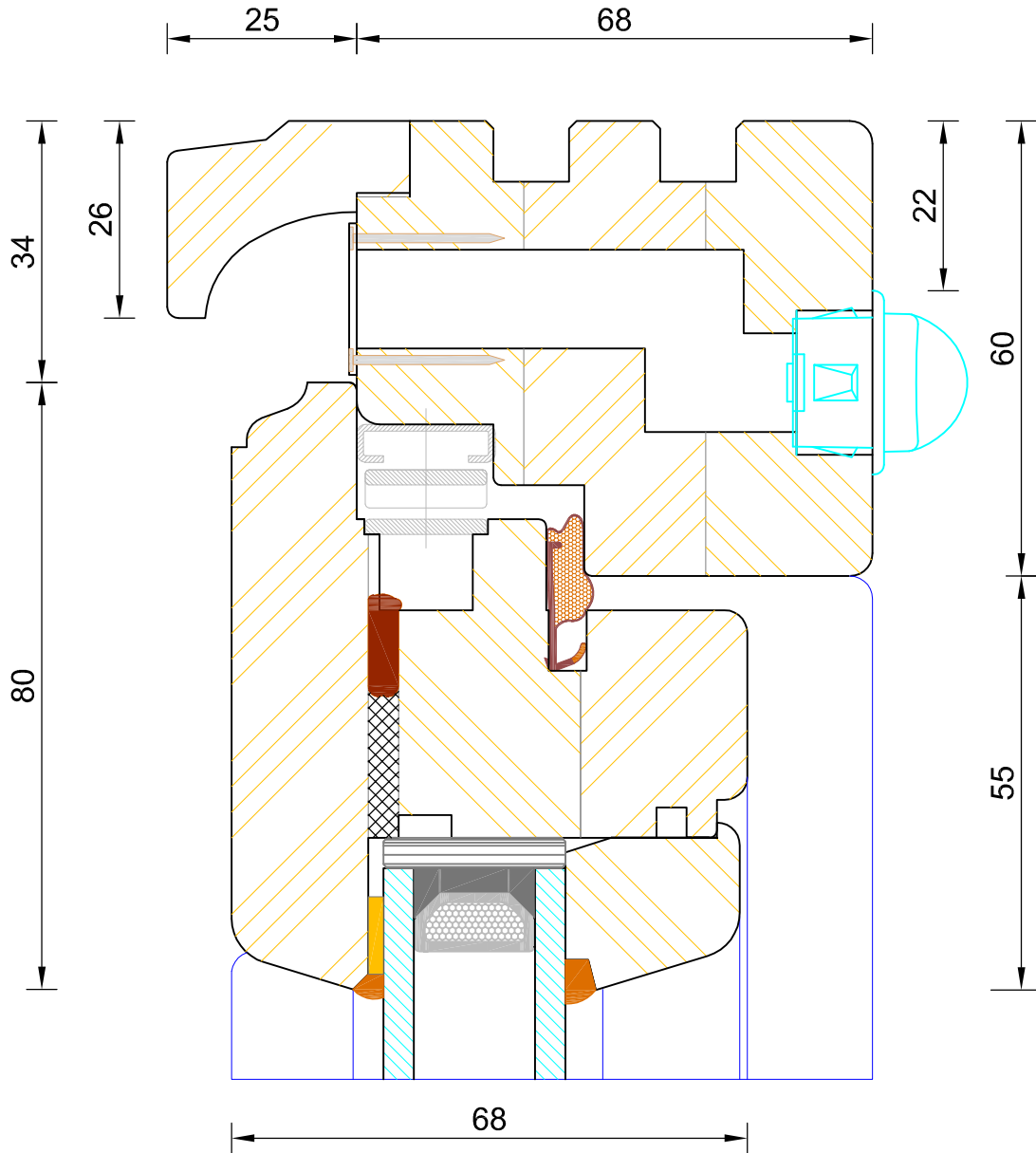

ALL DIMENSIONS IN mm ORIGINAL PLOT A4 SIZE (210x297)

SCALE
1 : 1

GENERAL TOLERANCE
+ 2

MATERIAL
Timber

S. Felczak	J. Stebelski	13.01.2011	
E.Pech		06.08.2007	0
DRAWN BY	CHECKED	DATE	ISSUE
DWG NO.	0106		SHT 1

TITLE
LIPPED CASEMENT
Head Section Frame & Sash

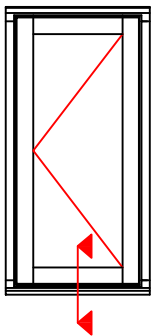
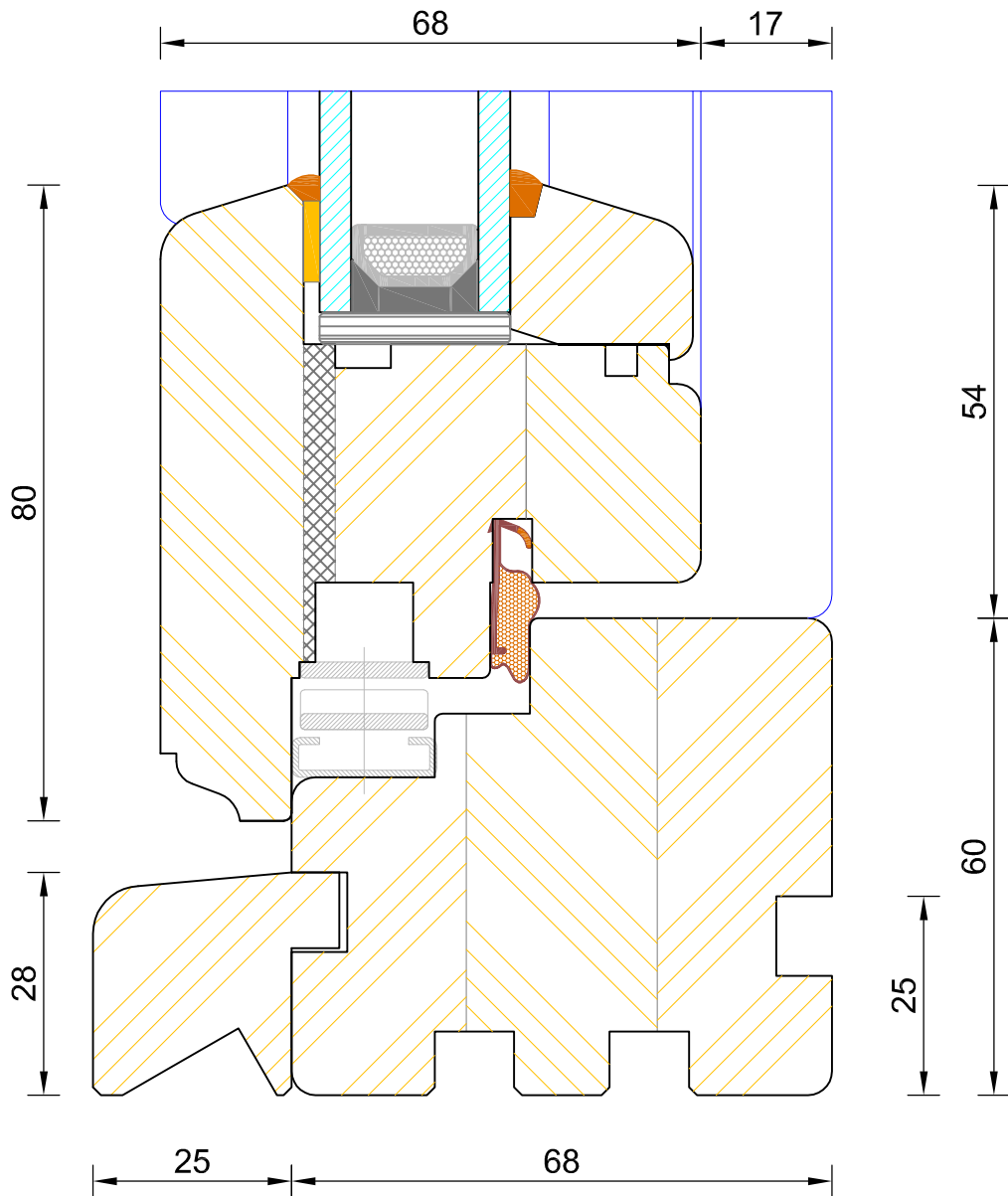

CILL EXTENSION - available options:
 25mm (93mm o/a) / 47mm (115mm o/a) / 62mm (130mm o/a) /
 87mm (155mm o/a) / 100mm (168mm o/a) / 114mm (182mm o/a) /
 125mm (193mm o/a) / 140mm (208mm o/a)

ALL DIMENSIONS IN mm		ORIGINAL PLOT A4 SIZE (210x297)					
SCALE	GENERAL TOLERANCE	MATERIAL					
1 : 1	+ 2	Timber		S. Felczak	J. Stebelski	13.01.2011	
TITLE				E.Pech		06.08.2007	0
				LIPPED CASEMENT		DRAWN BY	CHECKED
Cill Section Frame & Sash (side hung)				DWG NO.		0107	SHT 1

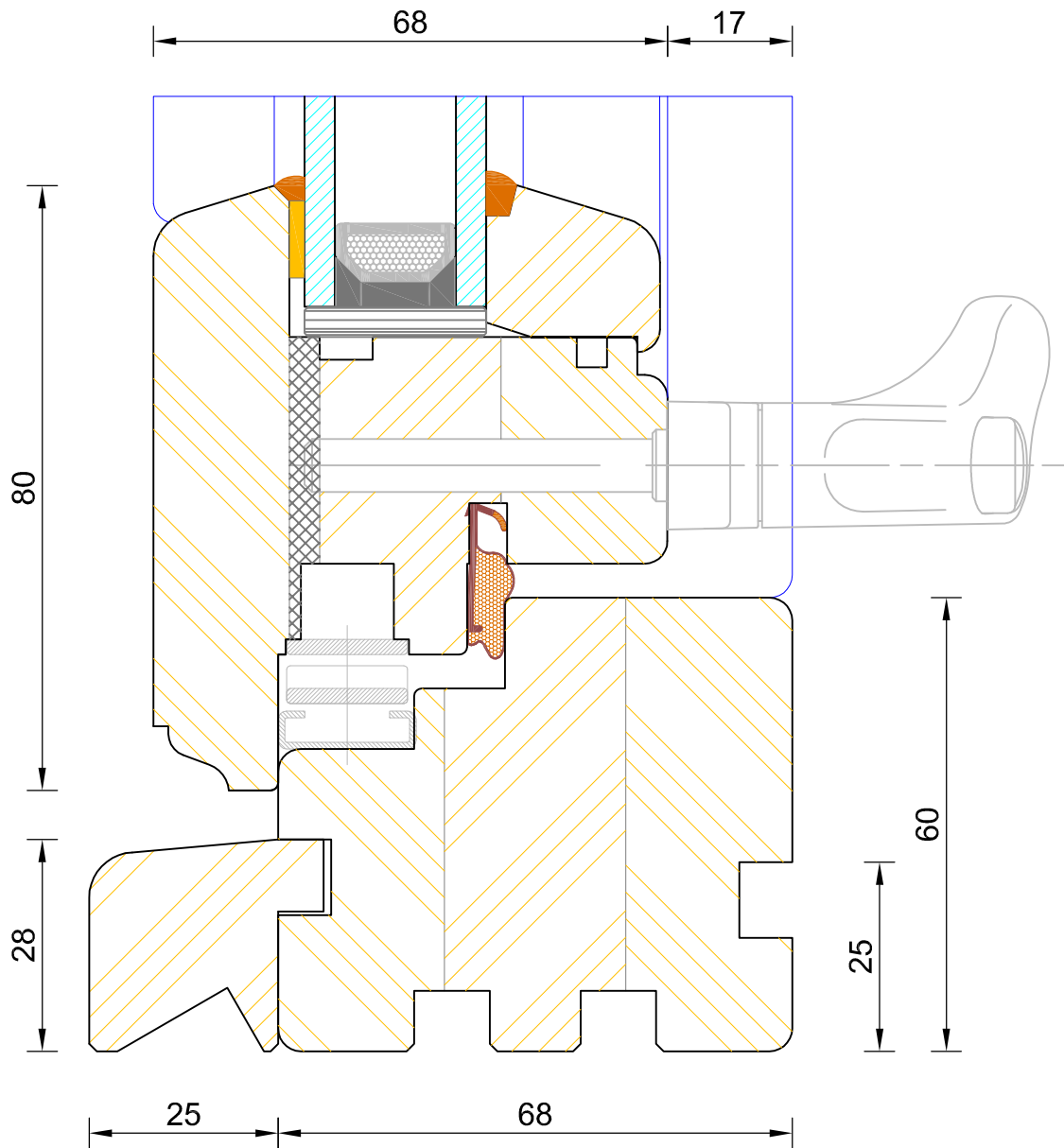

CILL EXTENSION - available options:

25mm (93mm o/a) / 47mm (115mm o/a) / 62mm (130mm o/a) /
 87mm (155mm o/a) / 100mm (168mm o/a) / 114mm (182mm o/a) /
 125mm (193mm o/a) / 140mm (208mm o/a)

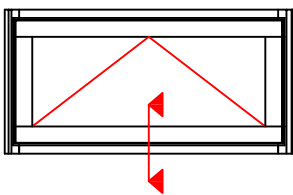

ALL DIMENSIONS IN mm		ORIGINAL PLOT A4 SIZE (210x297)					
SCALE	GENERAL TOLERANCE	MATERIAL					
1 : 1	+ 2	Timber		S. Felczak	J. Stebelski	13.01.2011	
TITLE				E.Pech		06.08.2007	0
				LIPPED CASEMENT		DRAWN BY	CHECKED
Sole Section Frame & Sash (top hung)				DWG NO.		0108	SHT 1

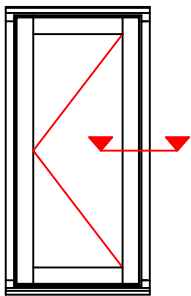
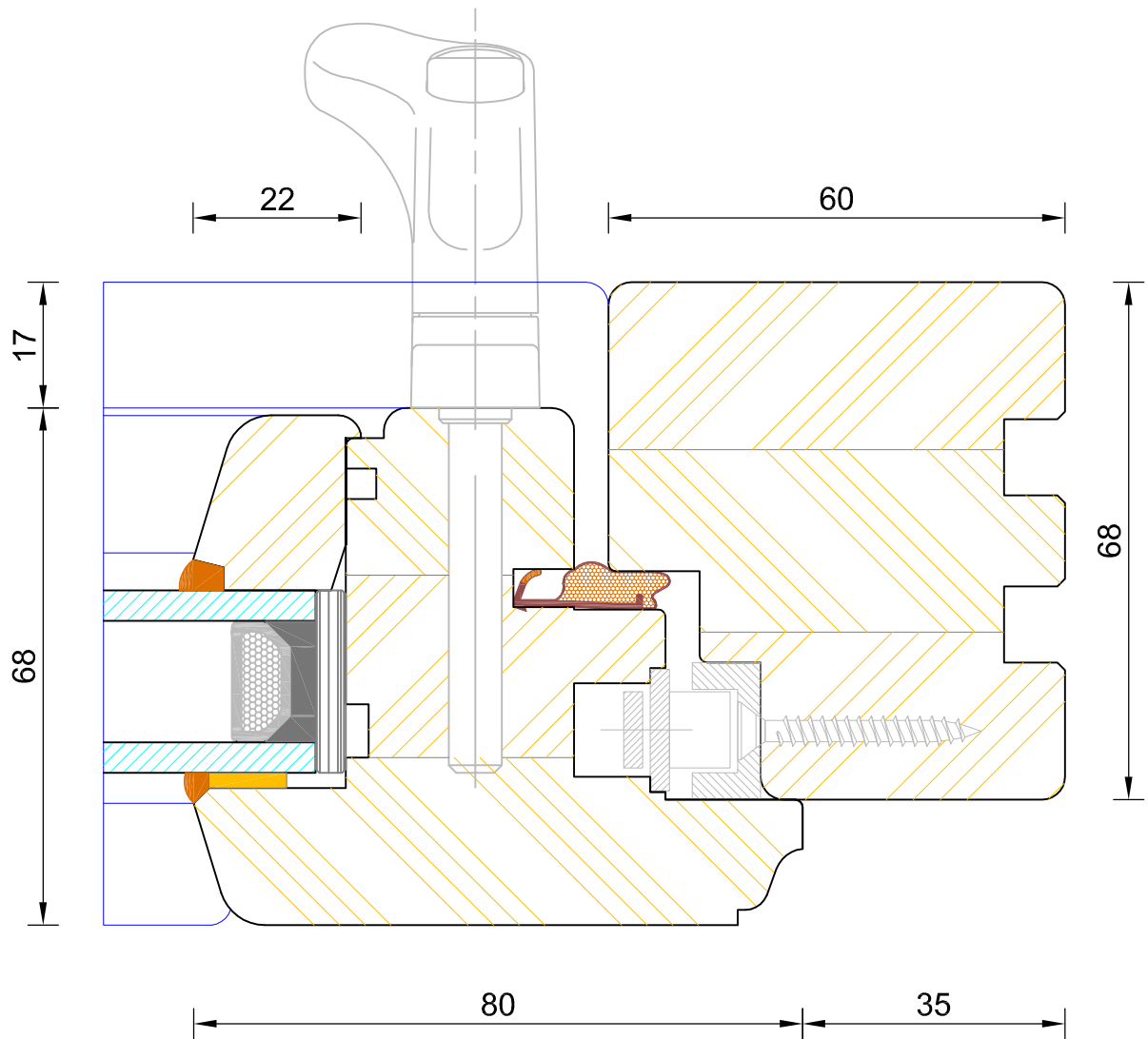

ALL DIMENSIONS IN mm		ORIGINAL PLOT A4 SIZE (210x297)					
SCALE	GENERAL TOLERANCE	MATERIAL					
1 : 1	+ 2	Timber		S. Felczak	J. Stebelski	13.01.2011	
				E.Pech		06.08.2007	0
TITLE			DRAWN BY	CHECKED	DATE	ISSUE	
LIPPED CASEMENT			DWG NO.	0109		SHT	1
Jamb Section Frame & Sash (Handle Side)							

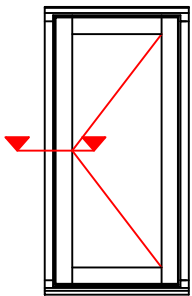
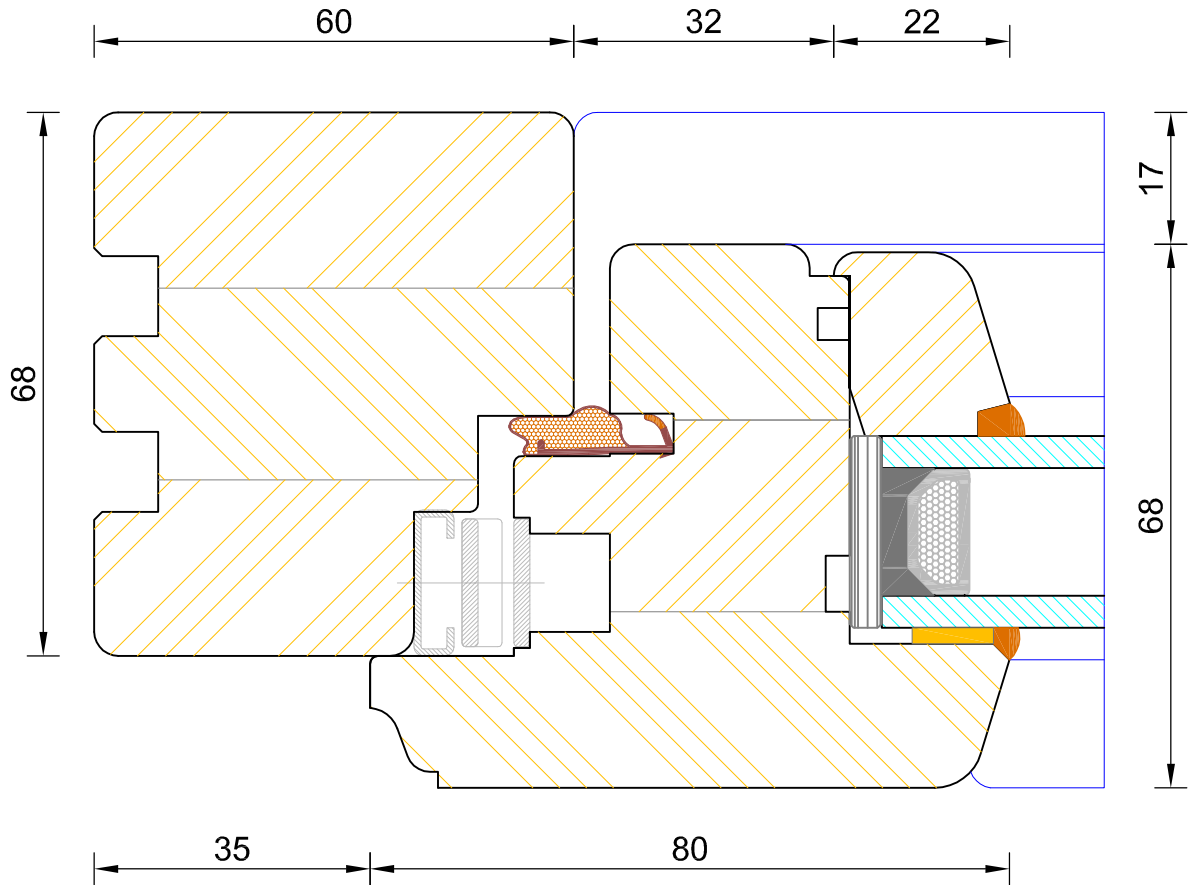

ALL DIMENSIONS IN mm		ORIGINAL PLOT A4 SIZE (210x297)					
SCALE	GENERAL TOLERANCE	MATERIAL					
1 : 1	+ 2	Timber		S. Felczak	J. Stebelski	13.01.2011	
TITLE				E.Pech		06.08.2007	0
LIPPED CASEMENT Jamb Section Frame & Sash (Hinge Side)				DRAWN BY	CHECKED	DATE	ISSUE
				DWG NO.	0110		SHT 1

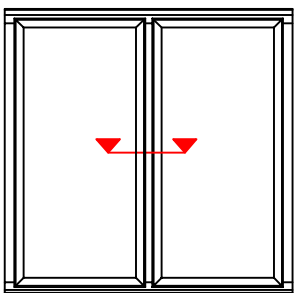
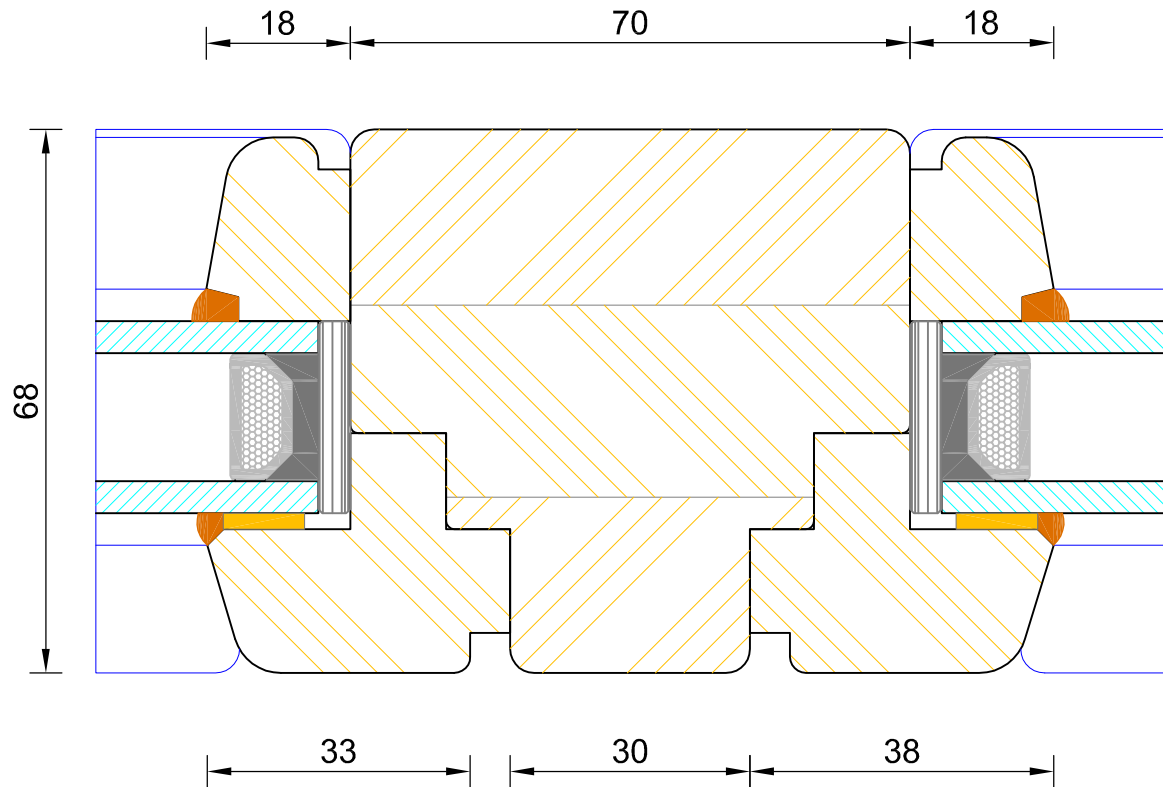

ALL DIMENSIONS IN mm		ORIGINAL PLOT A4 SIZE (210x297)					
SCALE	GENERAL TOLERANCE	MATERIAL					
1 : 1	+ 2	Timber		S. Felczak	J. Stebelski	13.01.2011	
TITLE				E.Pech		06.08.2007	0
LIPPED CASEMENT Solid Mullion Section (Fixed Light / Fixed Light)				DRAWN BY	CHECKED	DATE	ISSUE
				DWG NO.	0111		SHT 1

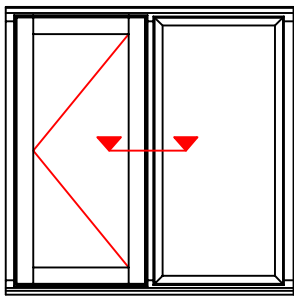
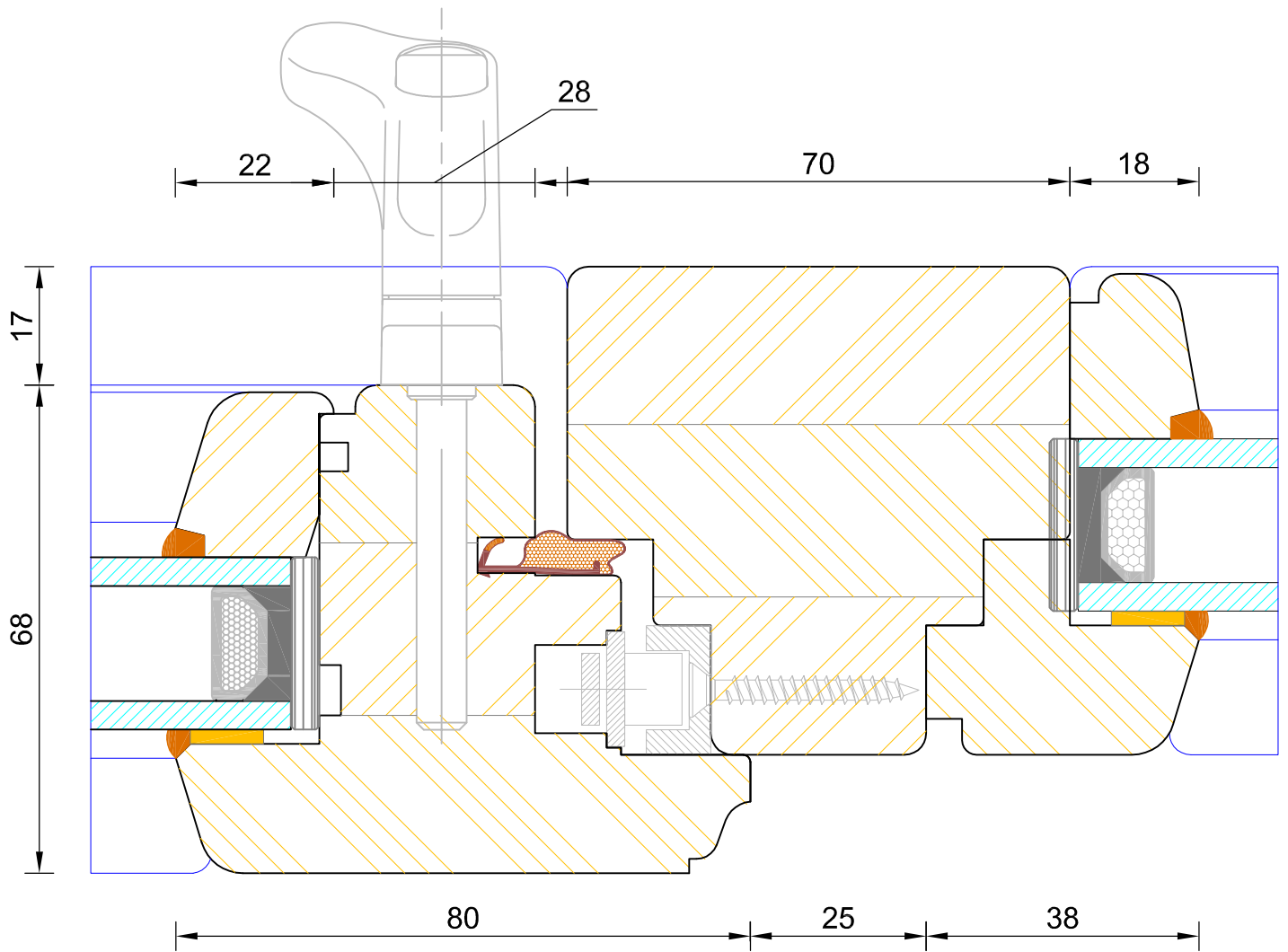

ALL DIMENSIONS IN mm		ORIGINAL PLOT A4 SIZE (210x297)					
SCALE	GENERAL TOLERANCE	MATERIAL					
1 : 1	+ 2	Timber		S. Felczak	J. Stebelski	13.01.2011	
TITLE				E.Pech		06.08.2007	0
				LIPPED CASEMENT		DRAWN BY	CHECKED
Solid Mullion Section (Sash / Fixed Light)				DWG NO.		0112	SHT 1

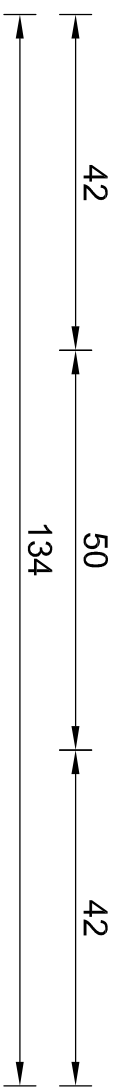
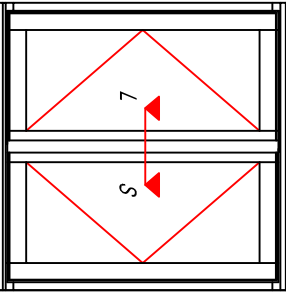
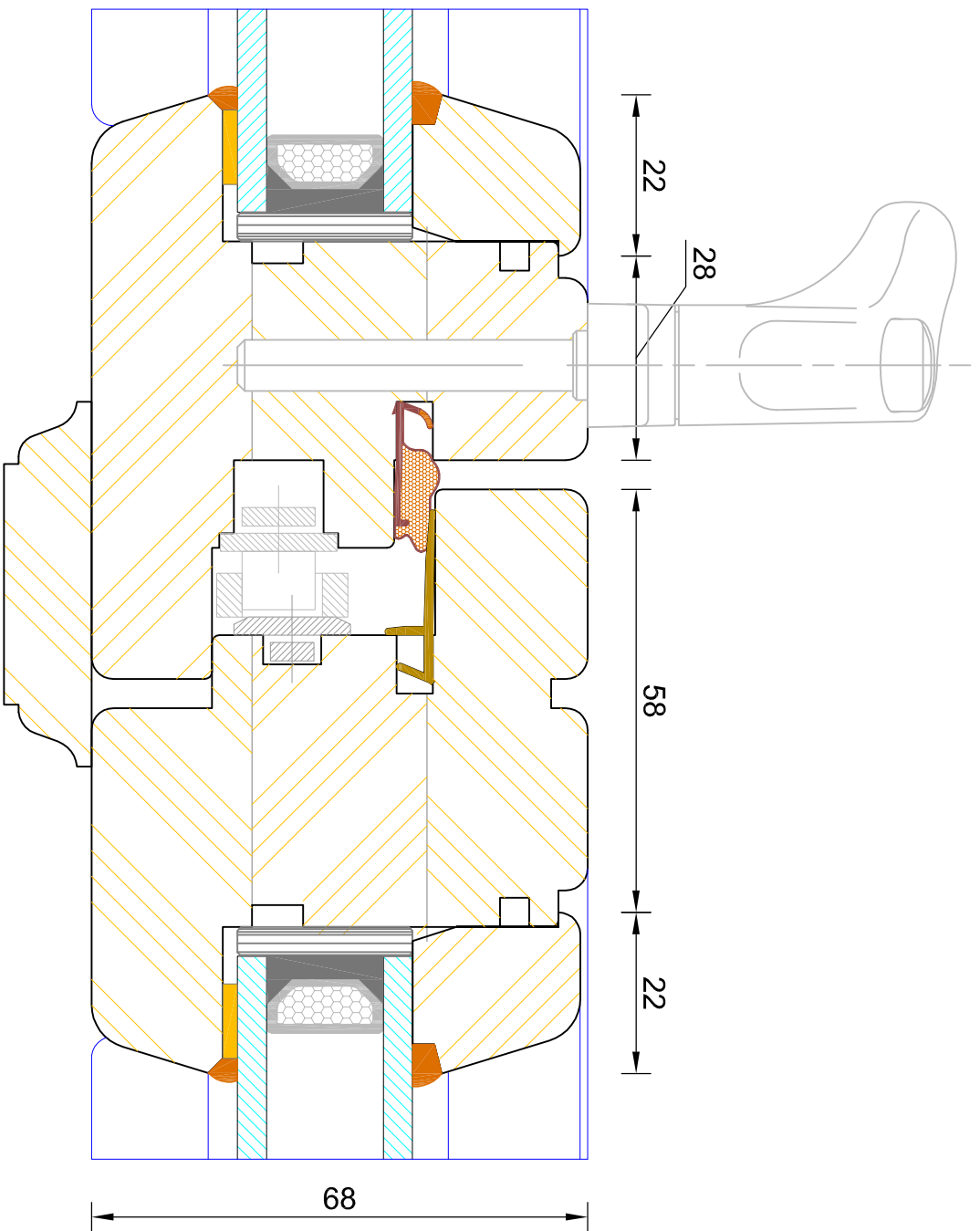

 Bereco DELIVERING THE DIFFERENCE		ALL DIMENSIONS IN mm SCALE 1 : 1 GENERAL TOLERANCE + 2		ORIGINAL PLOT A4 SIZE (210x297) MATERIAL Timber	
TITLE LIPPED CASEMENT Flying Mullion Section (Lead Sash/Slave Sash)		DRAWN BY S. Felczak E. Pech		CHECKED J. Stebelski	
DWG NO. 0113		DATE 13.01.2011 06.08.2007		ISSUE 0	
				SHIT 1	

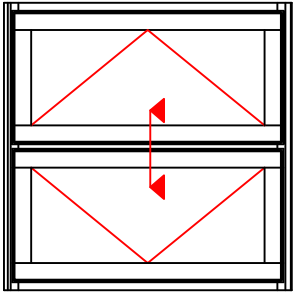
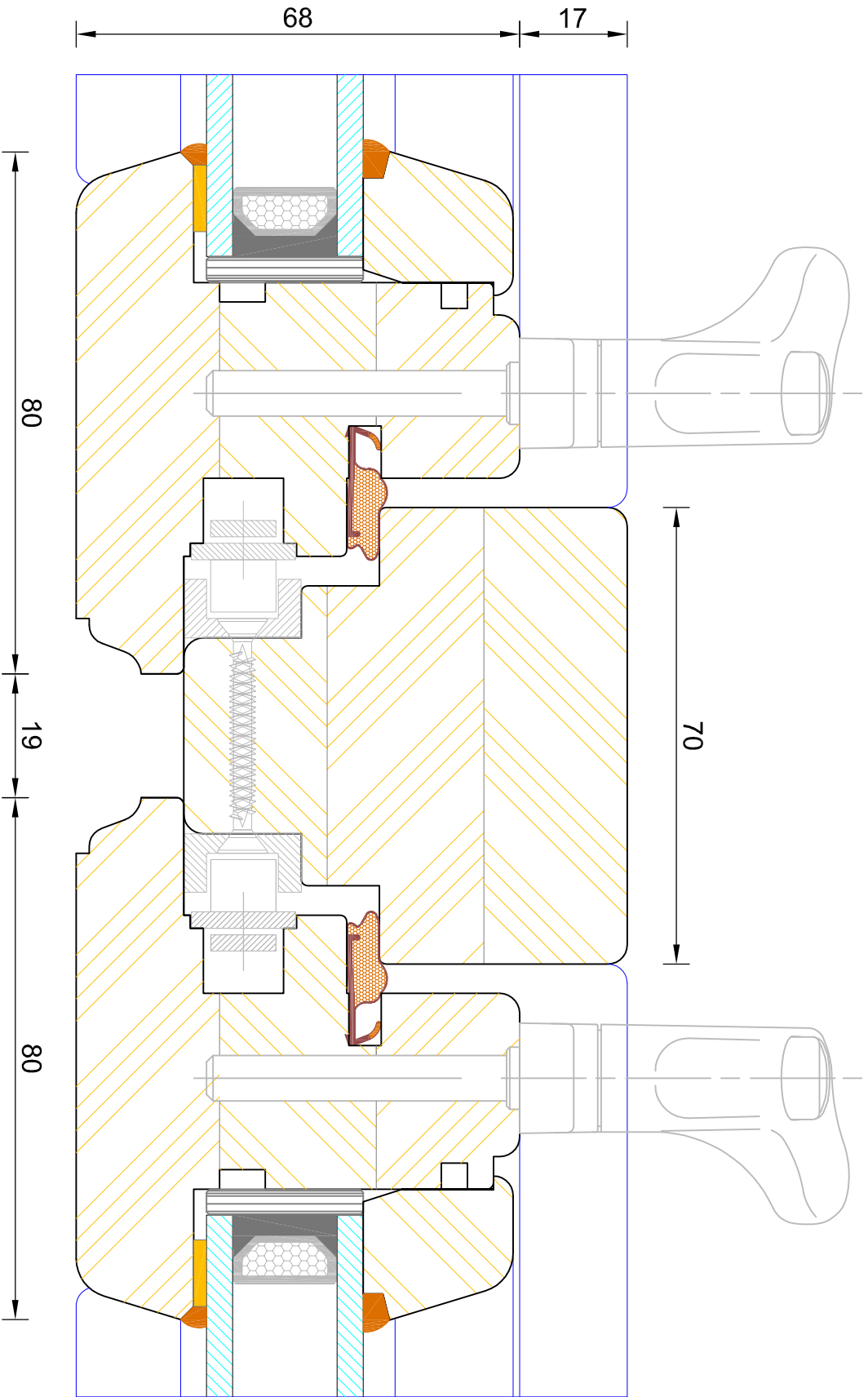

 Bereco DELIVERING THE DIFFERENCE		ALL DIMENSIONS IN mm SCALE 1 : 1 GENERAL TOLERANCE + 2		ORIGINAL PLOT A4 SIZE (210x297) MATERIAL Timber	
TITLE LIPPED CASEMENT Solid Mullion (Sash / Sash)		DRAWN BY S. Felczak E.Pech		CHECKED J. Stebelski	
DWG NO. 0114		DATE 13.01.2011 06.08.2007		ISSUE 0	
SHIT 1					

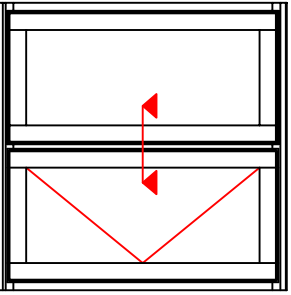
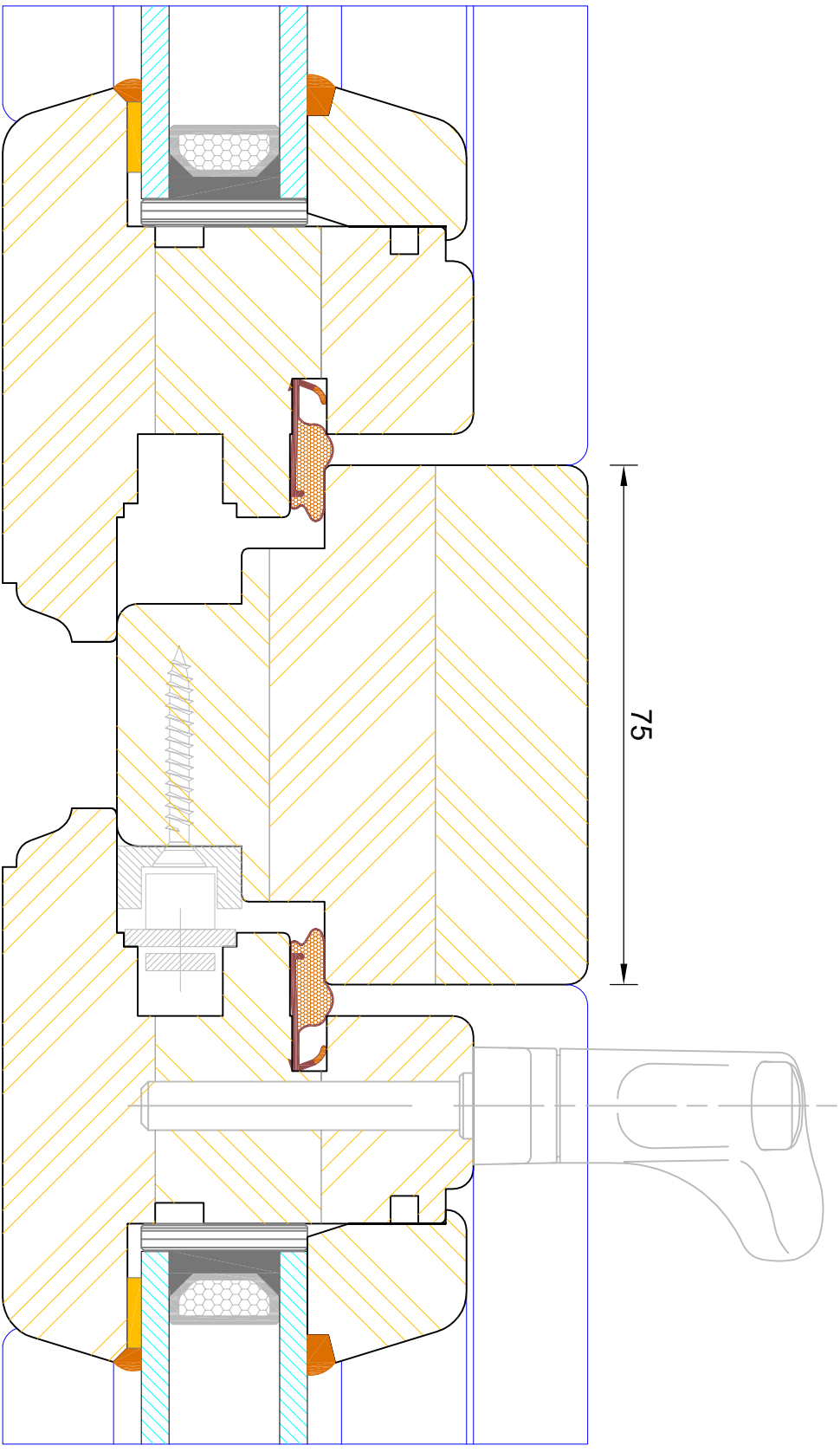

80 24 80 75

 Bereco DELIVERING THE DIFFERENCE		ALL DIMENSIONS IN mm ORIGINAL PLOT A4 SIZE (210x297)	
SCALE	GENERAL TOLERANCE	MATERIAL	
1 : 1	+ 2	Timber	
TITLE LIPPED CASEMENT Solid Mullion Section (Fixed Sash / Sash)			
DRAWN BY	CHECKED	DATE	ISSUE
S. Felczak E.Pech	J. Stebelski	13.01.2011 06.08.2007	0
DWG NO.	0115		SHT 1

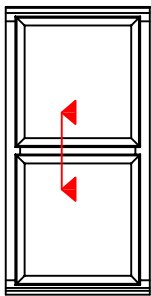
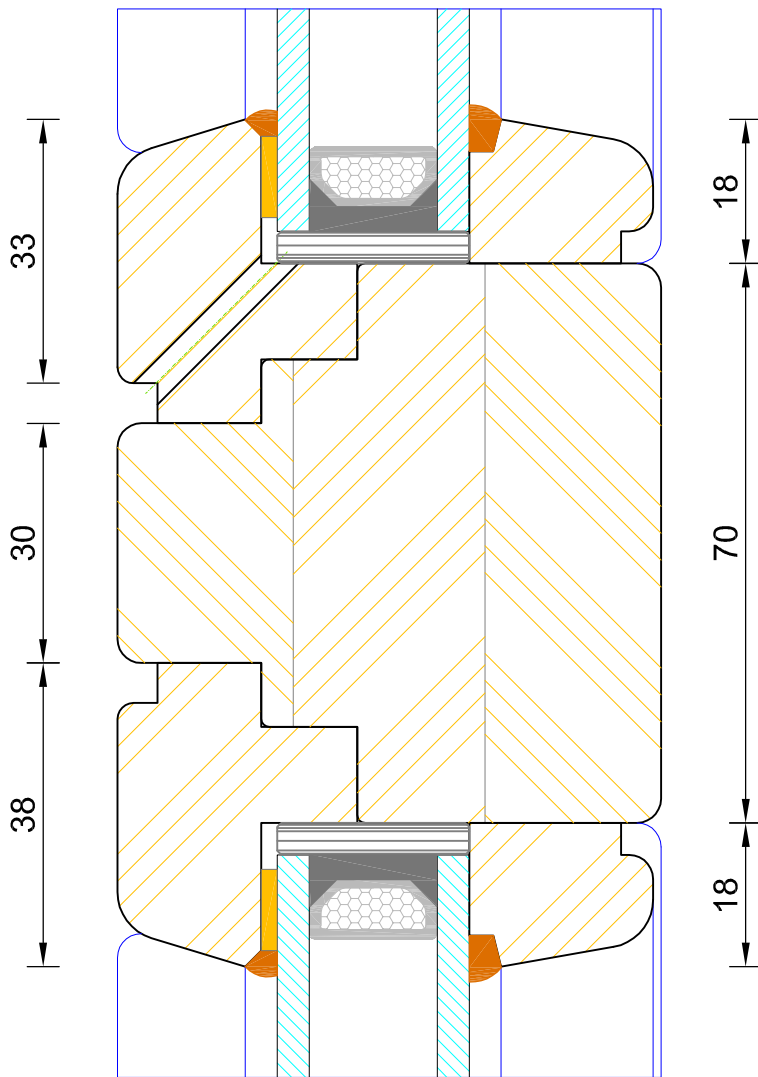

ALL DIMENSIONS IN mm		ORIGINAL PLOT A4 SIZE (210x297)					
SCALE	GENERAL TOLERANCE	MATERIAL					
1 : 1	+ 2	Timber		S. Felczak	J. Stebelski	13.01.2011	
TITLE				E.Pech		06.08.2007	0
				LIPPED CASEMENT		DRAWN BY	CHECKED
Solid Transom (Fixed Light / Fixed Light)				DWG NO.		0116	SHT 1

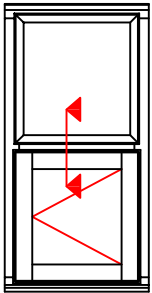
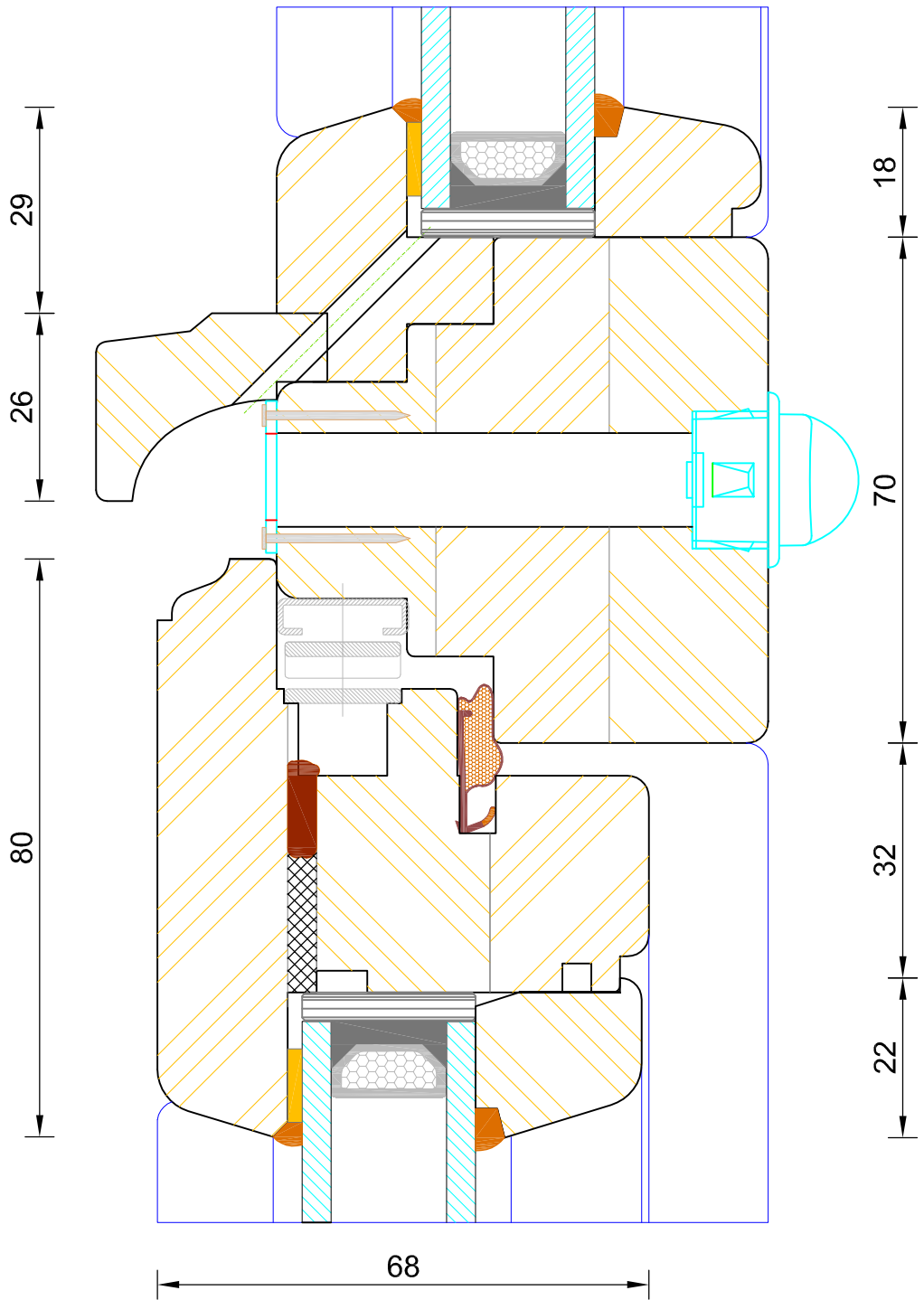

ALL DIMENSIONS IN mm		ORIGINAL PLOT A4 SIZE (210x297)					
SCALE	GENERAL TOLERANCE	MATERIAL		S. Felczak	J. Stebelski	13.01.2011	
1 : 1	+ 2	Timber		E.Pech		06.08.2007	0
TITLE			DRAWN BY	CHECKED	DATE	ISSUE	
LIPPED CASEMENT			DWG NO.	0117		SHT	1
Solid Transom (Fixed Light / Sash, incl Vent)							

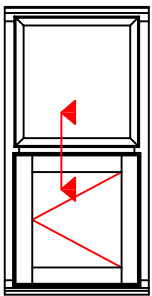
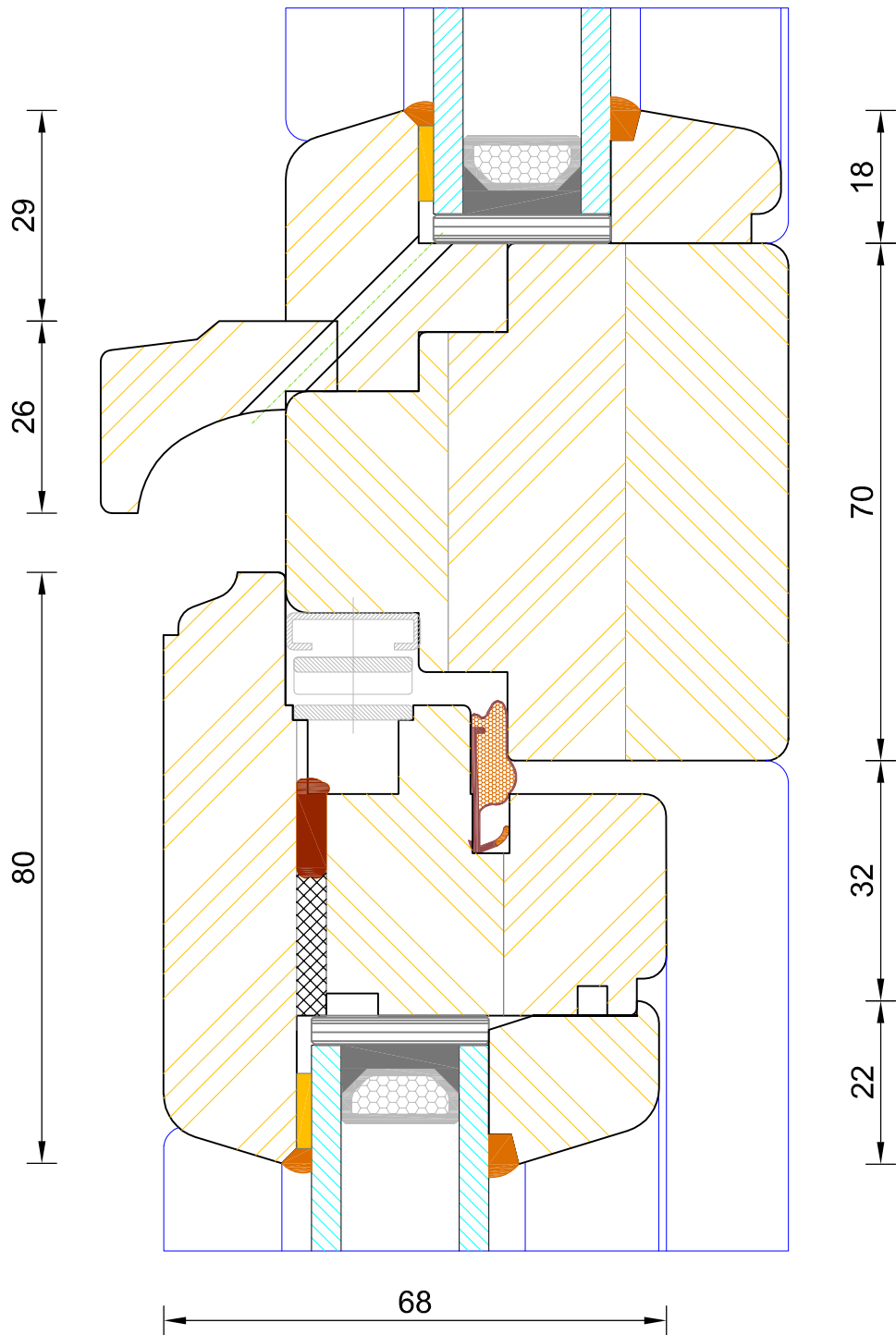

ALL DIMENSIONS IN mm		ORIGINAL PLOT A4 SIZE (210x297)					
SCALE	GENERAL TOLERANCE	MATERIAL					
1 : 1	+ 2	Timber		S. Felczak	J. Stebelski	13.01.2011	
				E.Pech		06.08.2007	0
TITLE				DRAWN BY	CHECKED	DATE	ISSUE
LIPPED CASEMENT				DWG NO.			SHT
Solid Transom (Fixed Light / Sash, no Vent)					0118		1

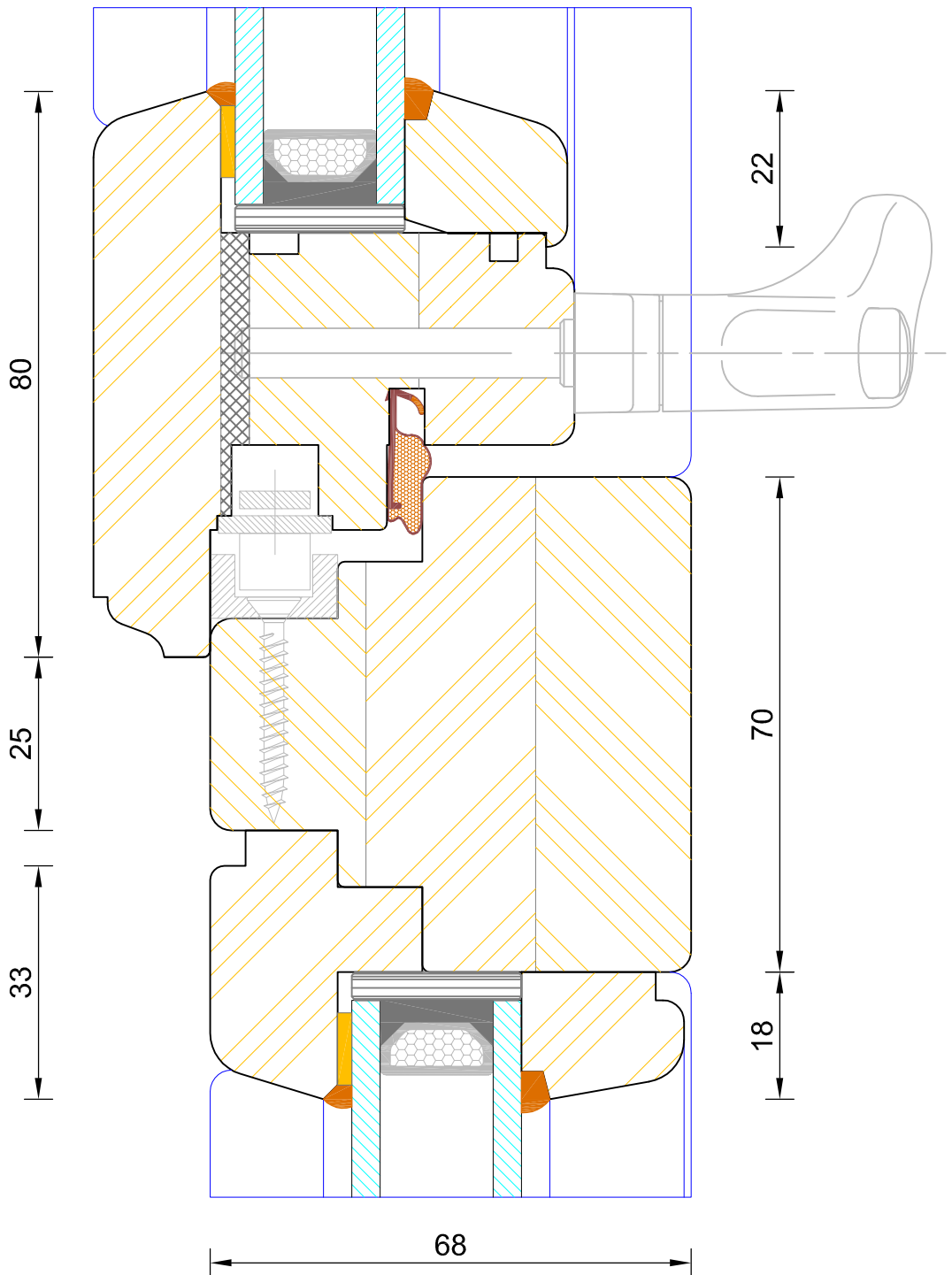
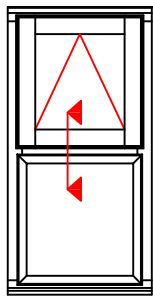

ALL DIMENSIONS IN mm		ORIGINAL PLOT A4 SIZE (210x297)					
SCALE	GENERAL TOLERANCE	MATERIAL					
1 : 1	+ 2	Timber		S. Felczak	J. Stebelski	13.01.2011	
				E.Pech		06.08.2007	0
TITLE				DRAWN BY	CHECKED	DATE	ISSUE
LIPPED CASEMENT				DWG NO.			SHT
Solid Transom (Sash / Fixed Light)					0119		1

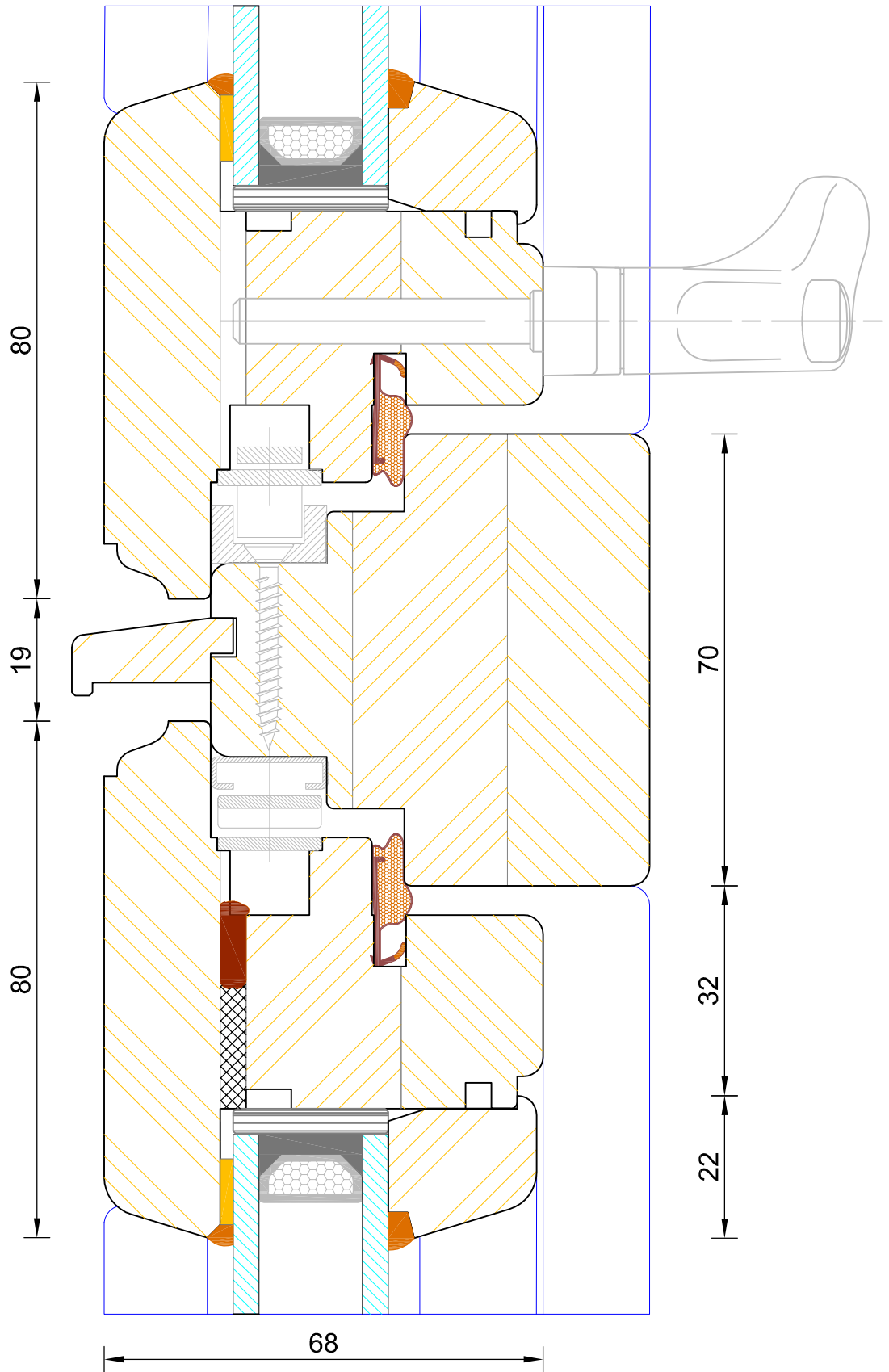
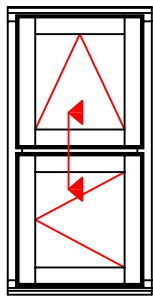

ALL DIMENSIONS IN mm		ORIGINAL PLOT A4 SIZE (210x297)					
SCALE	GENERAL TOLERANCE	MATERIAL		S. Felczak	J. Stebelski	13.01.2011	
1 : 1	+ 2	Timber		E.Pech		06.08.2007	0
TITLE	LIPPED CASEMENT Solid Transom (Sash / Sash)			DRAWN BY	CHECKED	DATE	ISSUE
				DWG NO.	0120		SHT 1

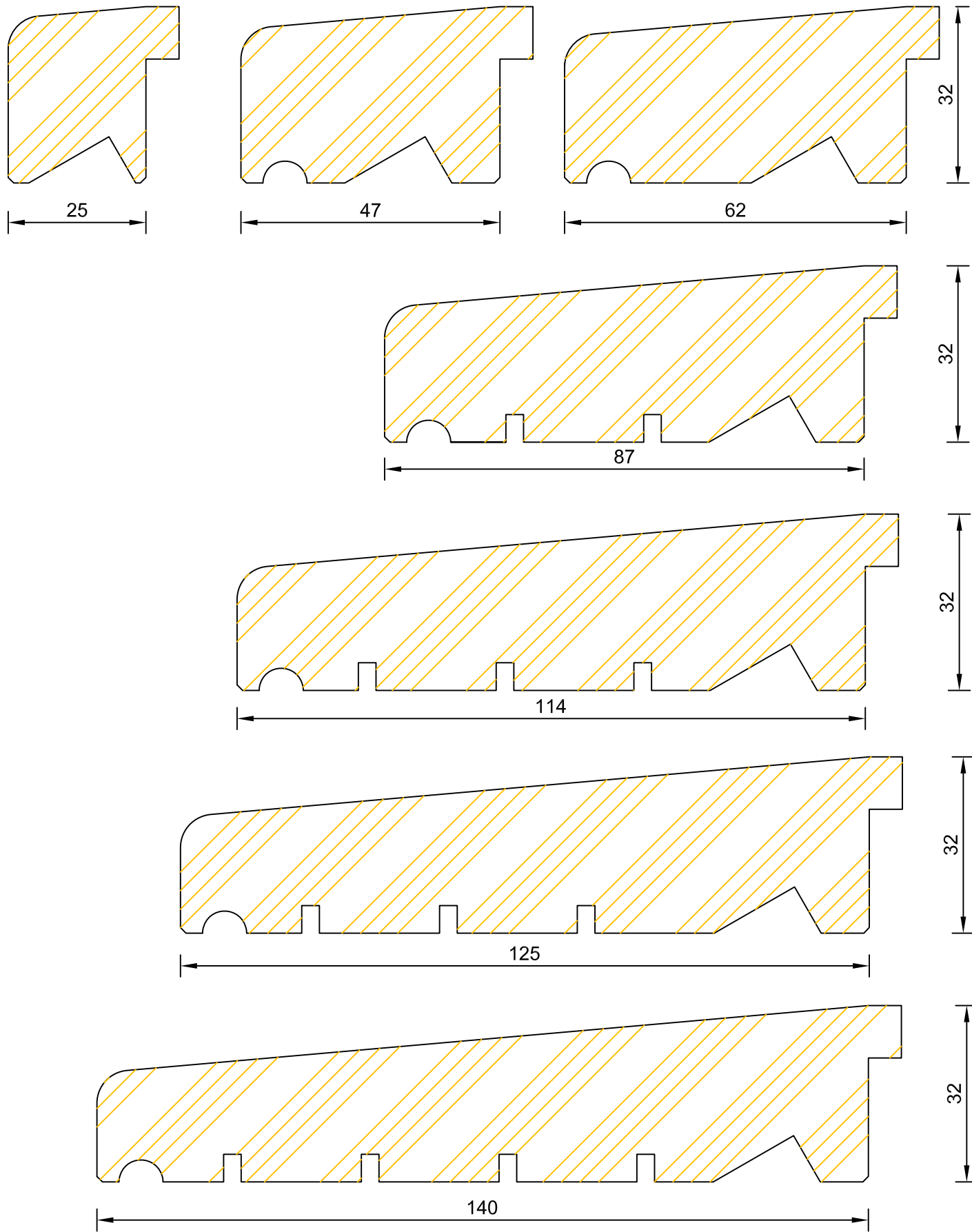

ALL DIMENSIONS IN mm ORIGINAL PLOT A4 SIZE (210x297)

SCALE 1 : 1	GENERAL TOLERANCE + 2	MATERIAL Timber
----------------	--------------------------	--------------------

TITLE
FLUSH DOOR OPEN IN
Cill Extension Details

S. Felczak	J. Stebelski	27.01.2011	
E.Pech		06.08.2007	0
DRAWN BY	CHECKED	DATE	ISSUE
DWG NO.	1101		SHT 1

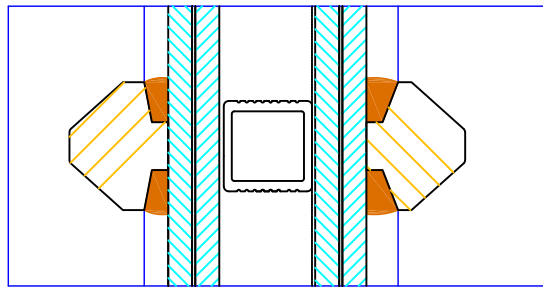

16

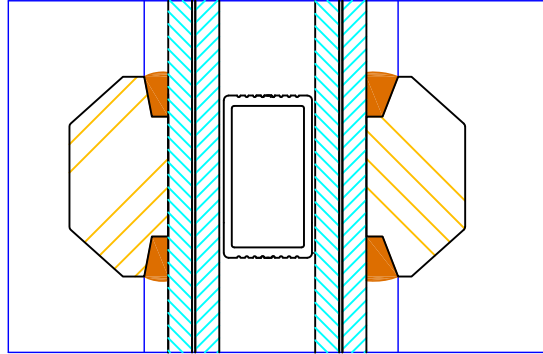

25

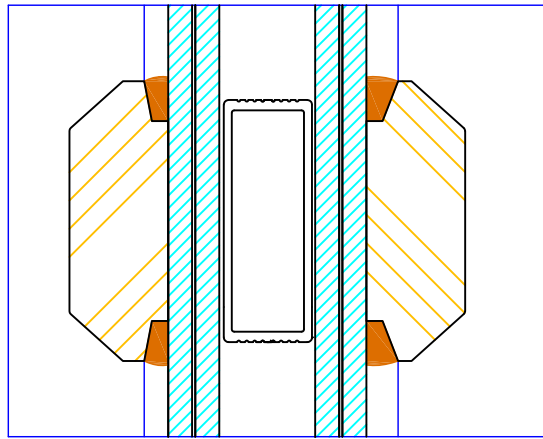

35

60 (varies min 60/ max 137mm)

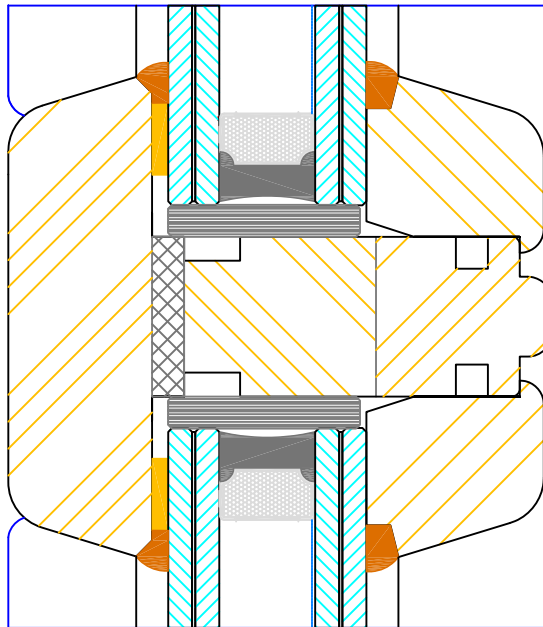

22
16
22

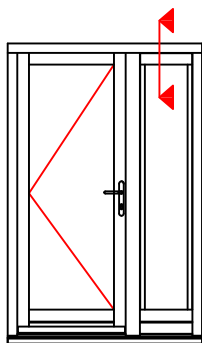
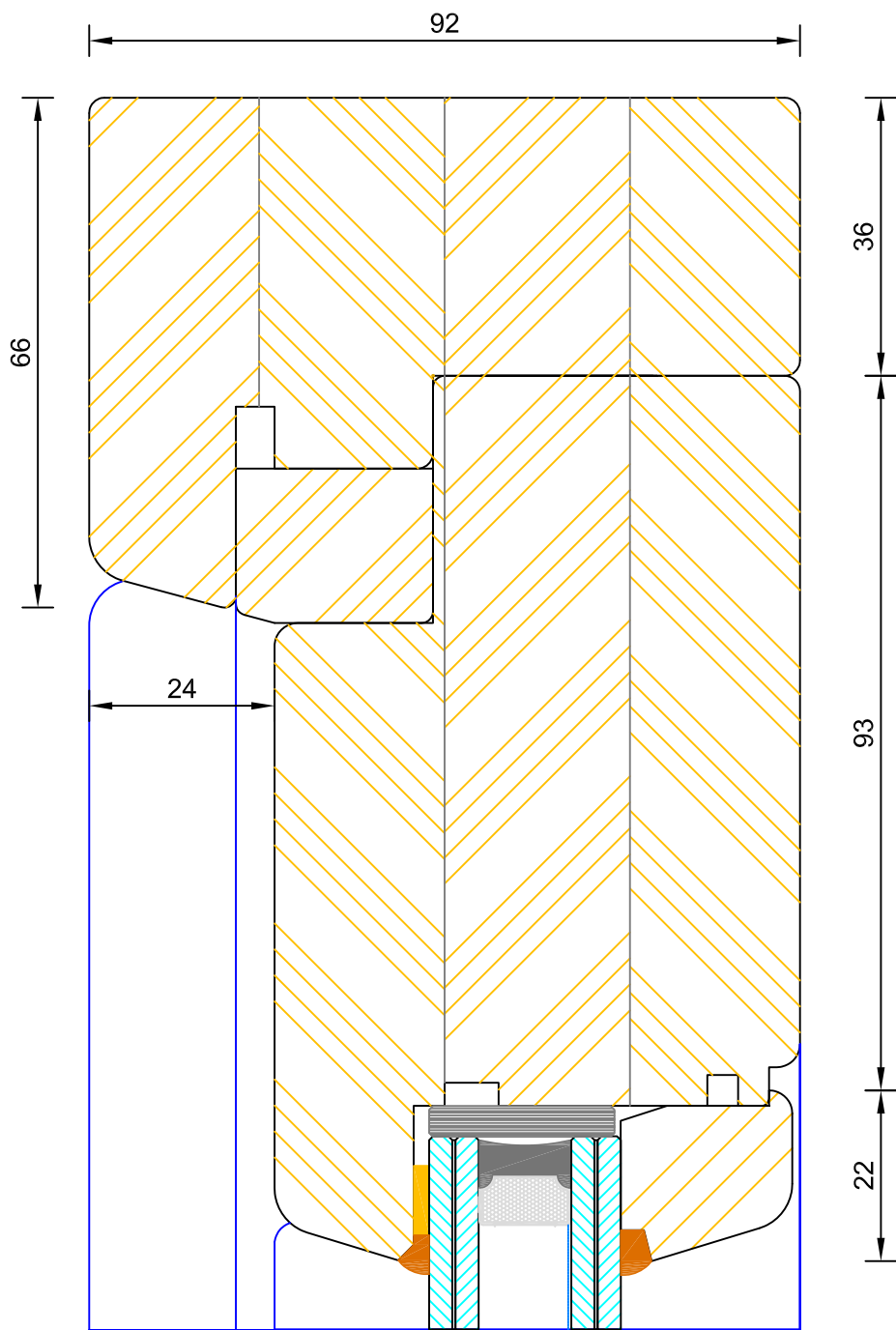

ALL DIMENSIONS IN mm		ORIGINAL PLOT A4 SIZE (210x297)					
SCALE	GENERAL TOLERANCE	MATERIAL					
1 : 1	+ 2	Timber		S. Felczak	J. Stebelski	27.01.2011	
				E.Pech		06.08.2007	0
TITLE		DRAWN BY		CHECKED	DATE	ISSUE	
FLUSH DOOR OPEN IN Head Section Sidelight		DWG NO.		1103		SHT	1

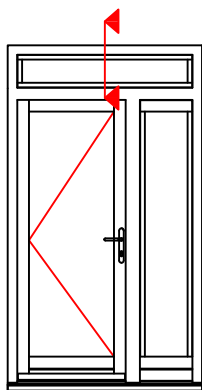
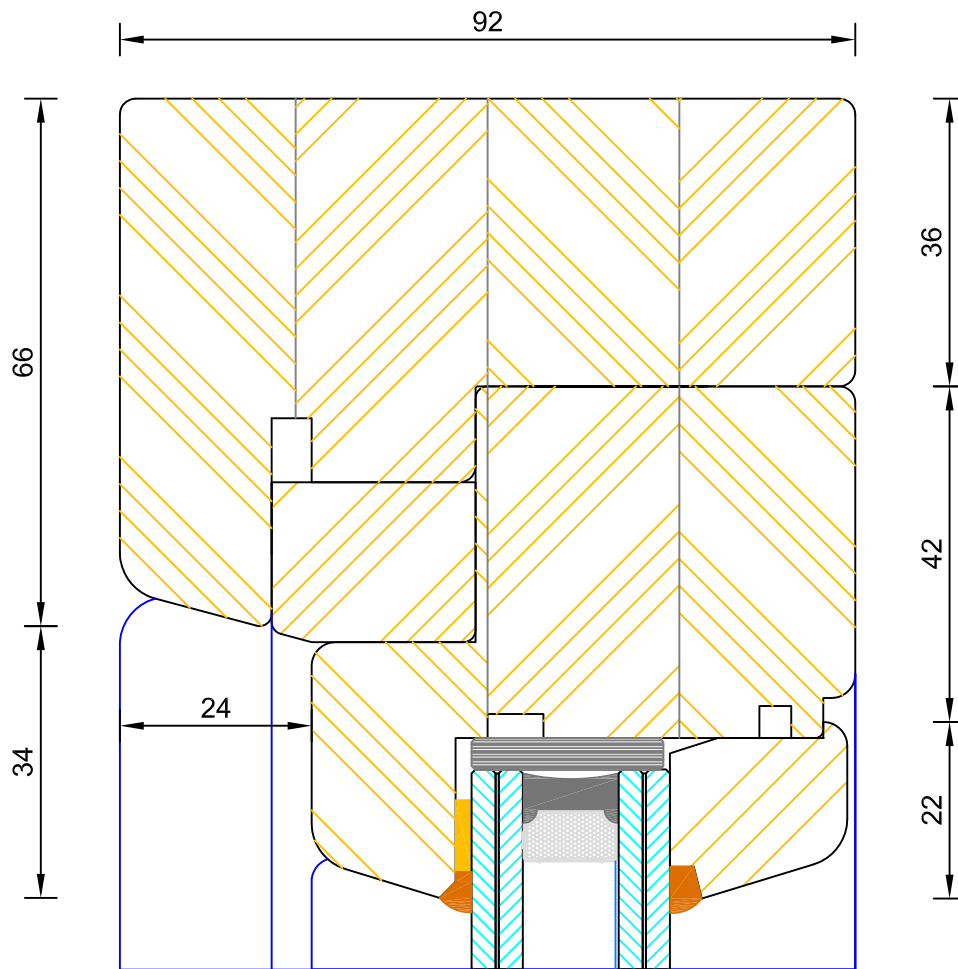

ALL DIMENSIONS IN mm		ORIGINAL PLOT A4 SIZE (210x297)					
SCALE	GENERAL TOLERANCE	MATERIAL					
1 : 1	+ 2	Timber		S. Felczak	J. Stebelski	27.01.2011	
				E.Pech		06.08.2007	0
TITLE				DRAWN BY	CHECKED	DATE	ISSUE
FLUSH DOOR OPEN IN Head Section Fanlight				DWG NO.			SHT
				1104			1

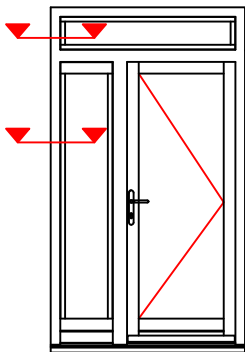
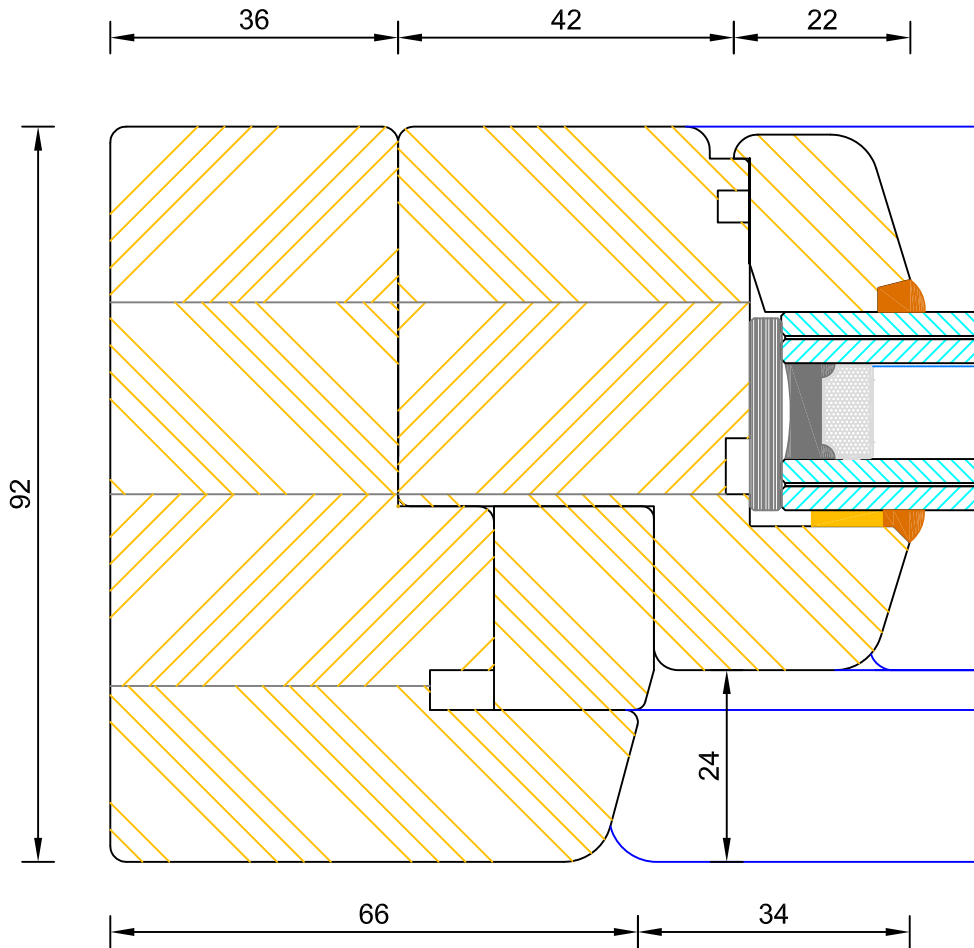

ALL DIMENSIONS IN mm		ORIGINAL PLOT A4 SIZE (210x297)					
SCALE	GENERAL TOLERANCE	MATERIAL					
1 : 1	+ 2	Timber		S. Felczak	J. Stebelski	27.01.2011	
TITLE				E.Pech		06.08.2007	0
FLUSH DOOR OPEN IN Jamb Section Fanlight / Sidelight				DRAWN BY	CHECKED	DATE	ISSUE
				DWG NO. 1105			SHT 1

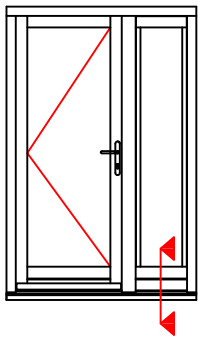
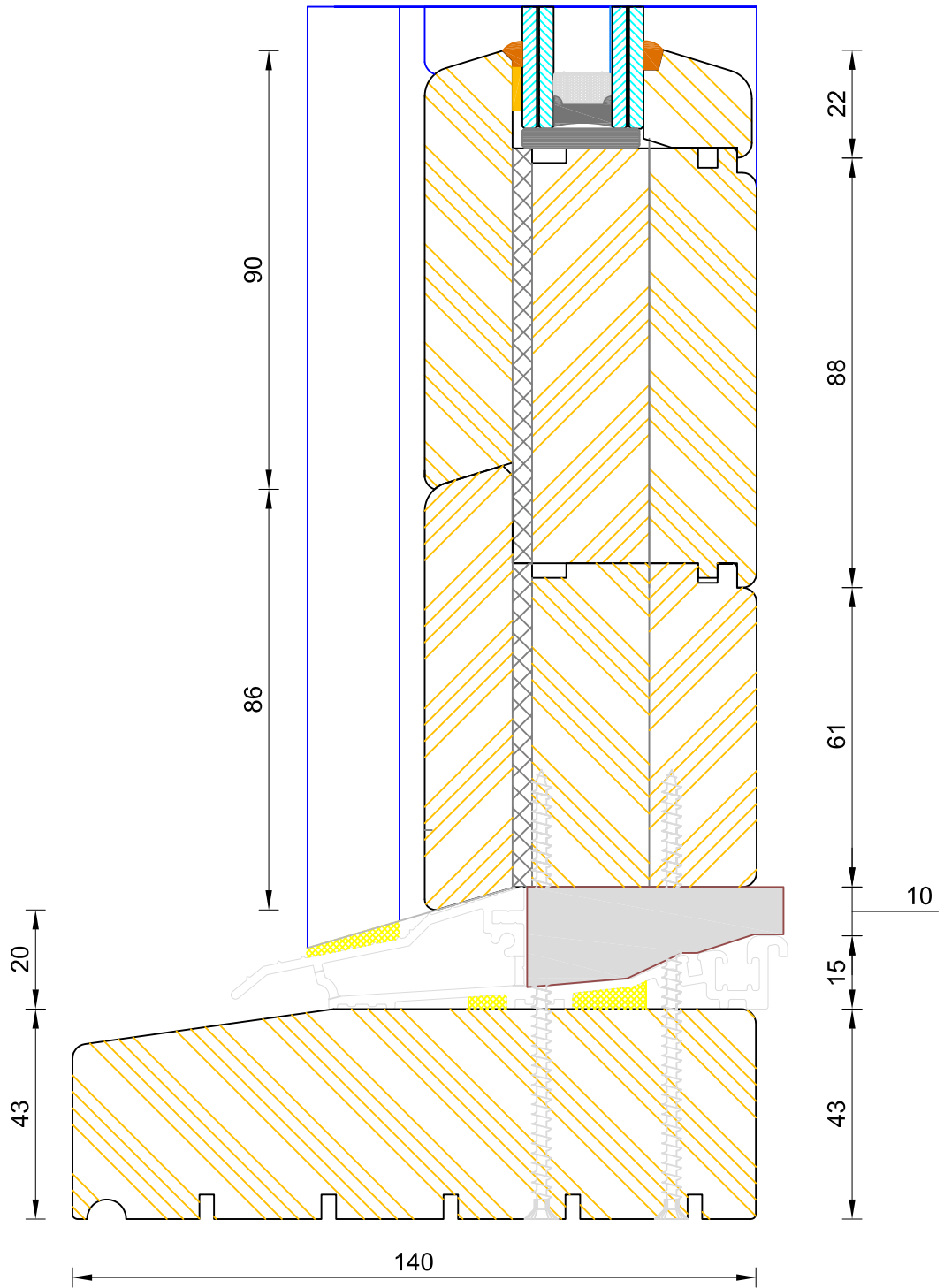

ALL DIMENSIONS IN mm		ORIGINAL PLOT A3 SIZE (297x420)					
SCALE	GENERAL TOLERANCE	MATERIAL	S. Felczak	J. Stebelski	27.01.2011		
1 : 1	+ 2	Timber	E.Pech		07.02.2008		
TITLE		DRAWN BY		CHECKED	DATE	ISSUE	
FLUSH DOOR OPEN IN Standard Threshold Silight (made as 1 unit; 140x43mm)		DWG NO.				SHT	
		1106				1	

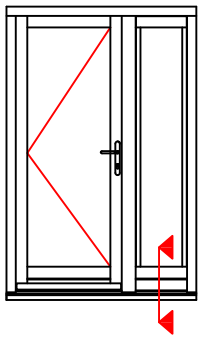
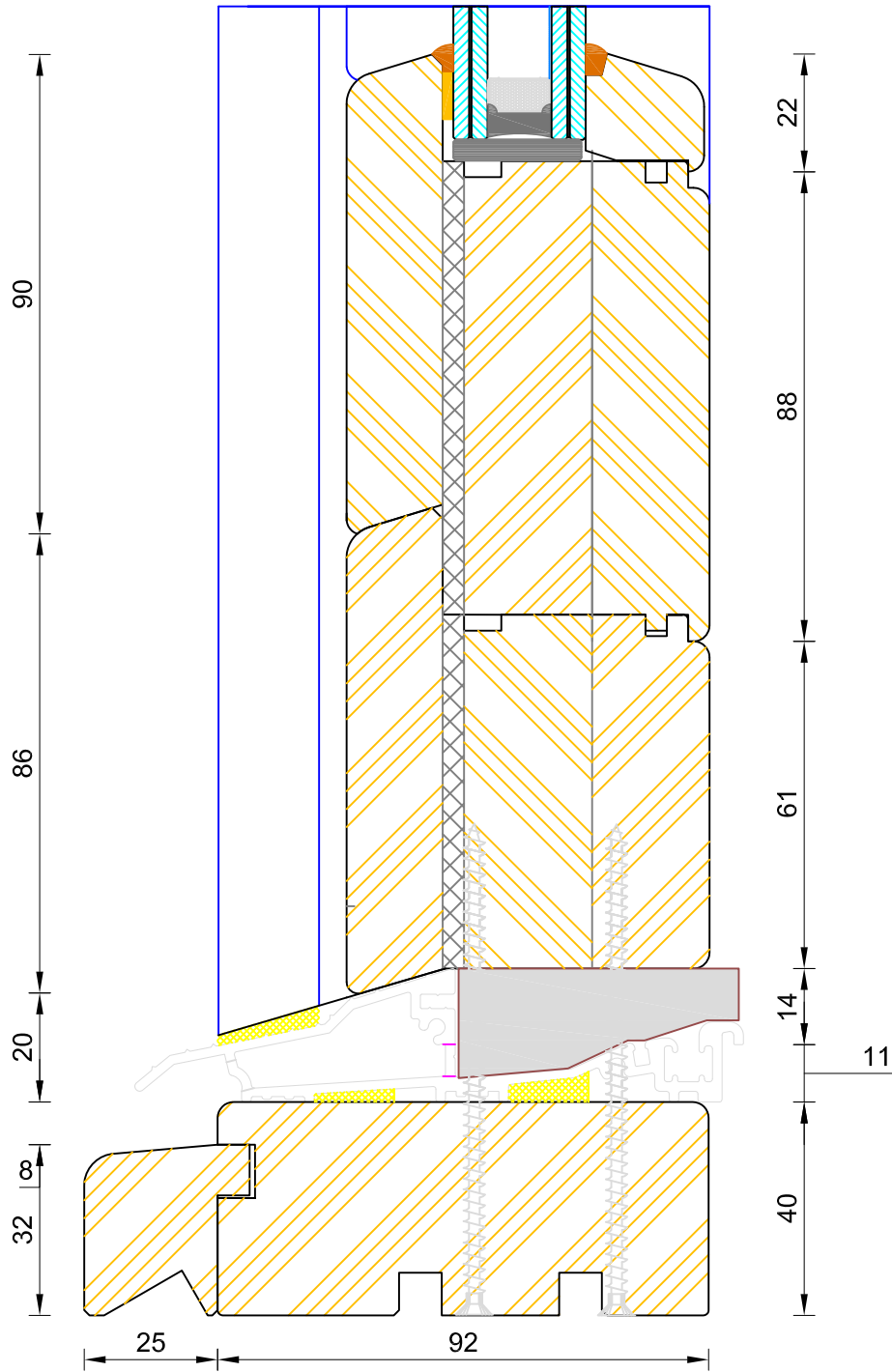

CILL EXTENSION - available options: 25mm (117mm o/a) / 47mm (139mm o/a) / 62mm (154mm o/a) / 87mm (179mm o/a) / 114mm (206mm o/a) / 125mm (217mm o/a) / 140mm (232mm o/a)

NOTE: Cill Extensions should be supported from underneath; the maximum overhang over Brick / Blockwork for cill extension should not exceed 25mm in order to avoid damage when stepped on. Warranties are invalidated when fitted with overhang in excess to that.

If not otherwise stated, Hardwood Threshold will be painted the same colour as Frame.

ALL DIMENSIONS IN mm		ORIGINAL PLOT A3 SIZE (297x420)					
SCALE	GENERAL TOLERANCE	MATERIAL					
1 : 1	+ 2	Timber		S. Felczak	J. Stebelski	27.01.2011	
TITLE				E.Pech		06.08.2007	0
FLUSH DOOR OPEN IN Site Coupling Threshold Sidelight (92x40mm)				DRAWN BY	CHECKED	DATE	ISSUE
				DWG NO. 1107			SHT 1

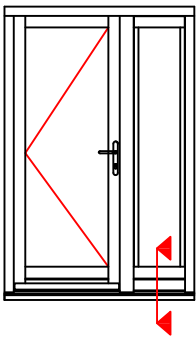
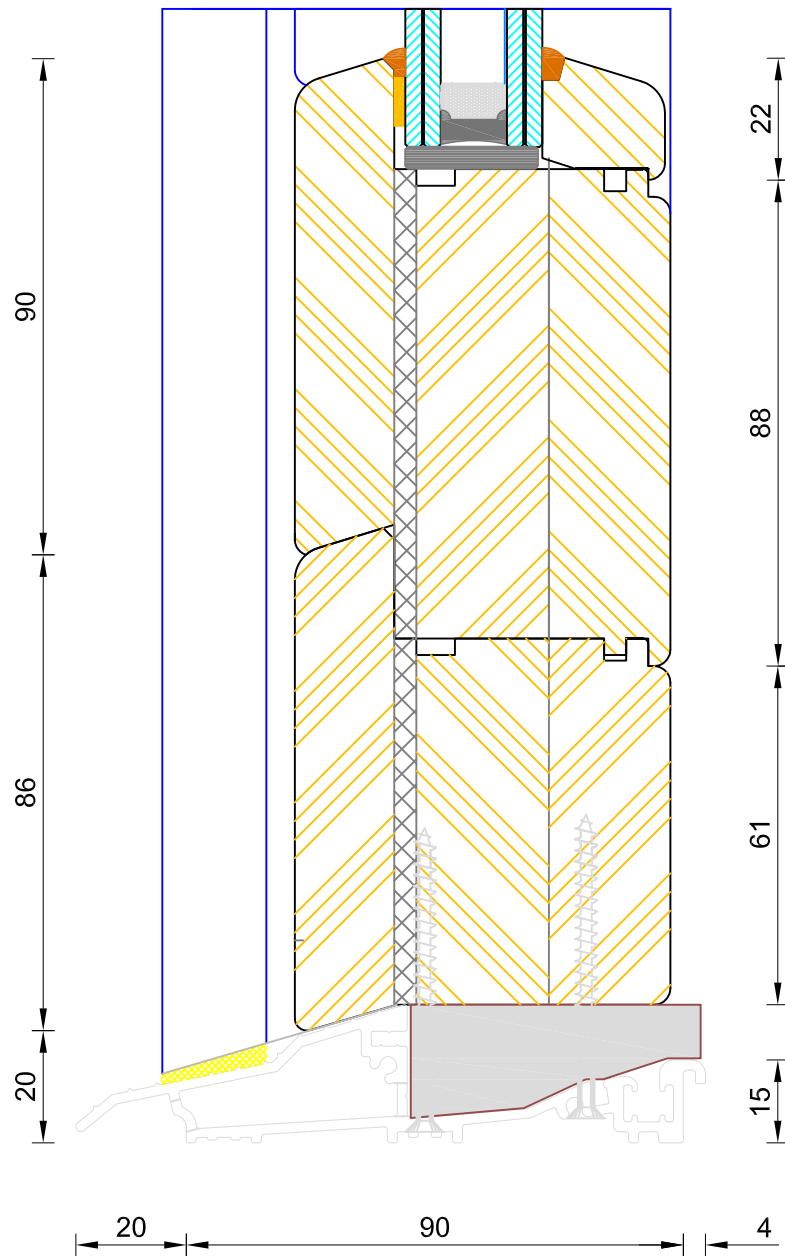

ALL DIMENSIONS IN mm		ORIGINAL PLOT A3 SIZE (297x420)					
SCALE	GENERAL TOLERANCE	MATERIAL					
1 : 1	+ 2	Timber		S. Felczak	J. Stebelski	27.01.2011	
				E.Pech		06.08.2007	0
TITLE				DRAWN BY	CHECKED	DATE	ISSUE
FLUSH DOOR OPEN IN							
Standard Mobility Threshold Sidelight				DWG NO.			SHT
(made as 1 unit)				1108			1

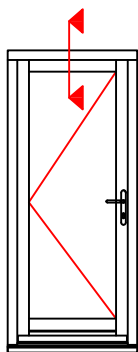
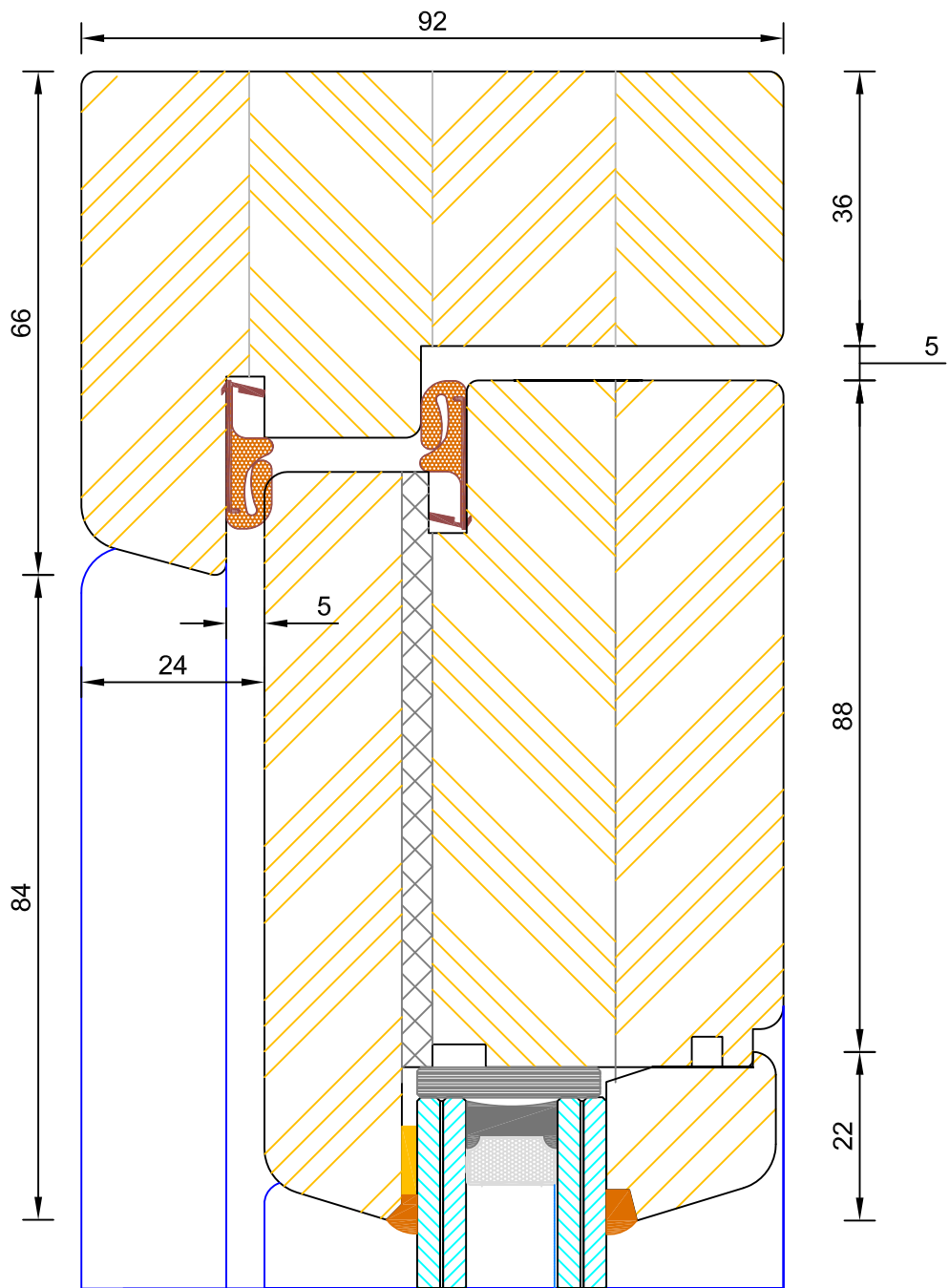

ALL DIMENSIONS IN mm		ORIGINAL PLOT A4 SIZE (210x297)					
SCALE	GENERAL TOLERANCE	MATERIAL		S. Felczak	J. Stebelski	27.01.2011	
1 : 1	+ 2	Timber		E.Pech		06.08.2007	0
TITLE			FLUSH DOOR OPEN IN	DRAWN BY	CHECKED	DATE	ISSUE
Head Section (Frame & Leaf)				DWG NO.	1109		SHT
							1

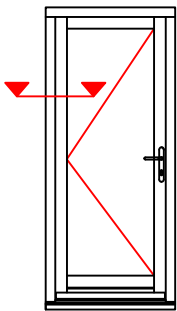
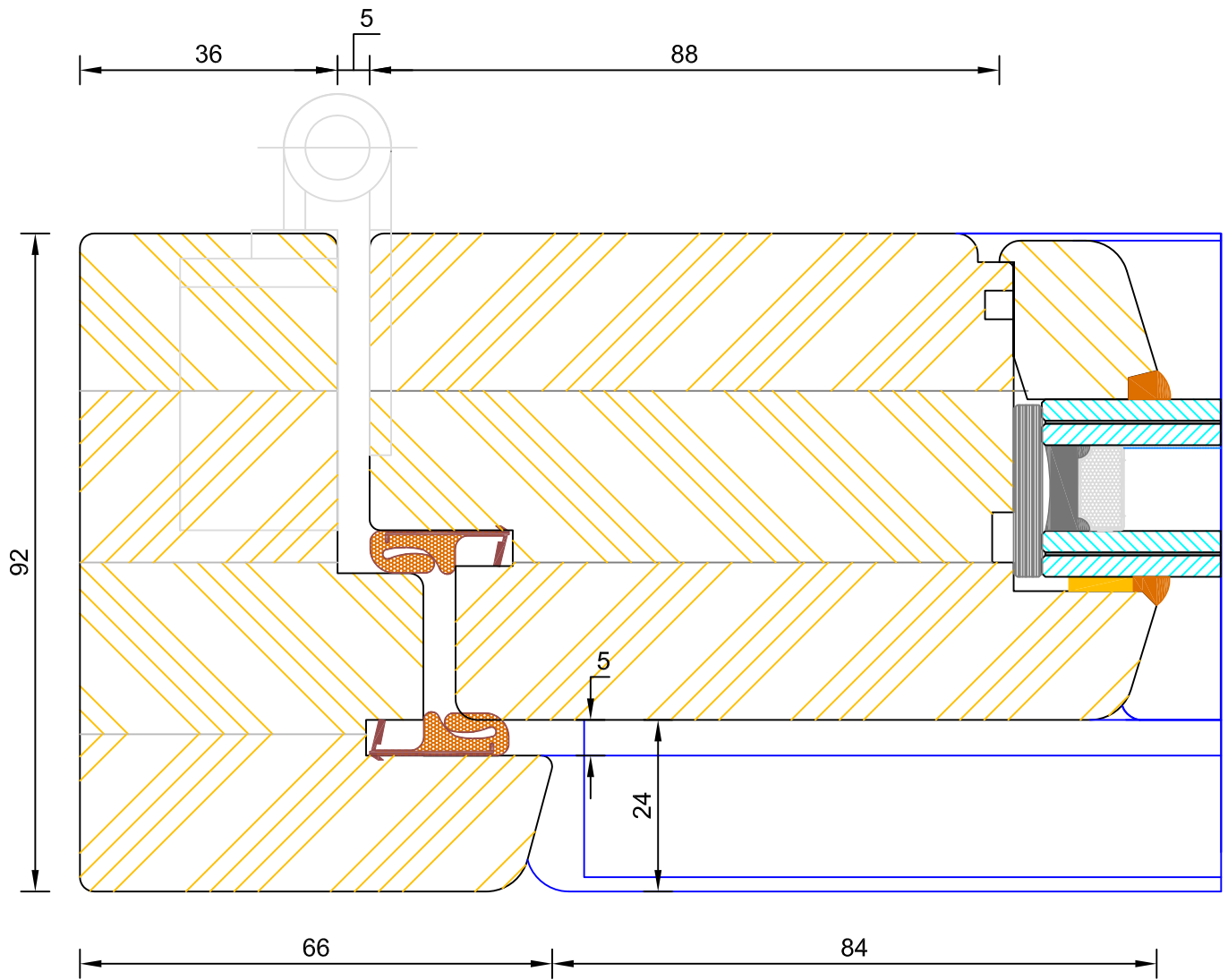

ALL DIMENSIONS IN mm		ORIGINAL PLOT A4 SIZE (210x297)					
SCALE	GENERAL TOLERANCE	MATERIAL					
1 : 1	+ 2	Timber		S. Felczak	J. Stebelski	27.01.2011	
TITLE				E.Pech		06.08.2007	0
FLUSH DOOR OPEN IN Jamb Section Frame & Leaf (Hinge Side)				DRAWN BY	CHECKED	DATE	ISSUE
				DWG NO. 1110			SHT 1

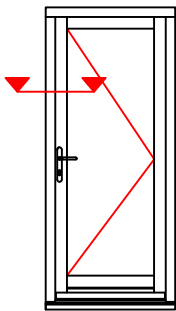
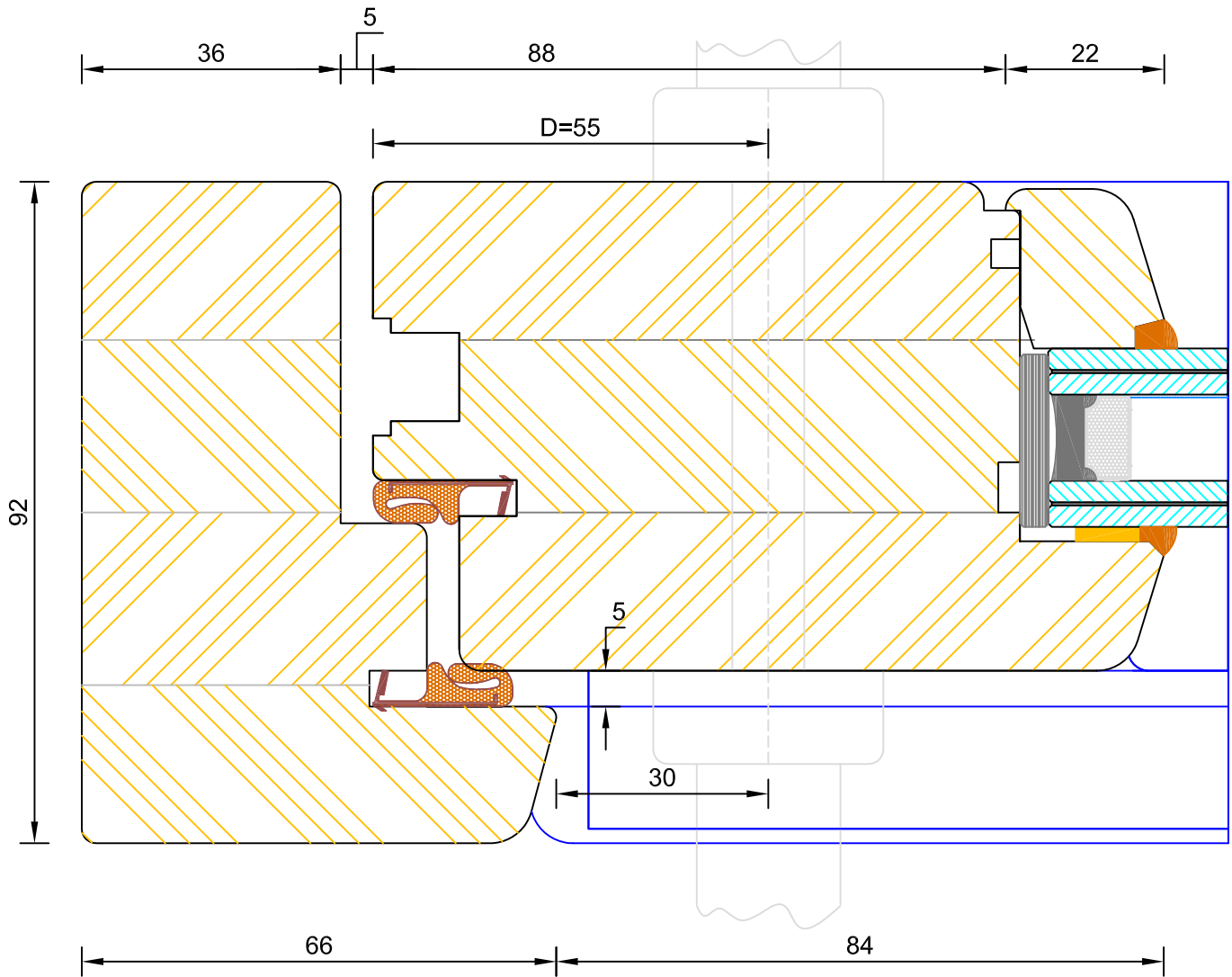

ALL DIMENSIONS IN mm ORIGINAL PLOT A4 SIZE (210x297)

SCALE
1 : 1

GENERAL
TOLERANCE
+ 2

MATERIAL
Timber

S. Felczak J. Stebelski 27.01.2011

E.Pech 06.08.2007 0

TITLE
FLUSH DOOR OPEN IN
Jamb Section Frame & Leaf (Handle Side)

DRAWN BY CHECKED DATE ISSUE

DWG NO. 1111 SHT 1

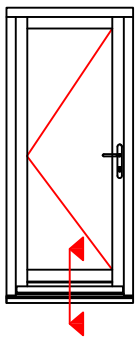
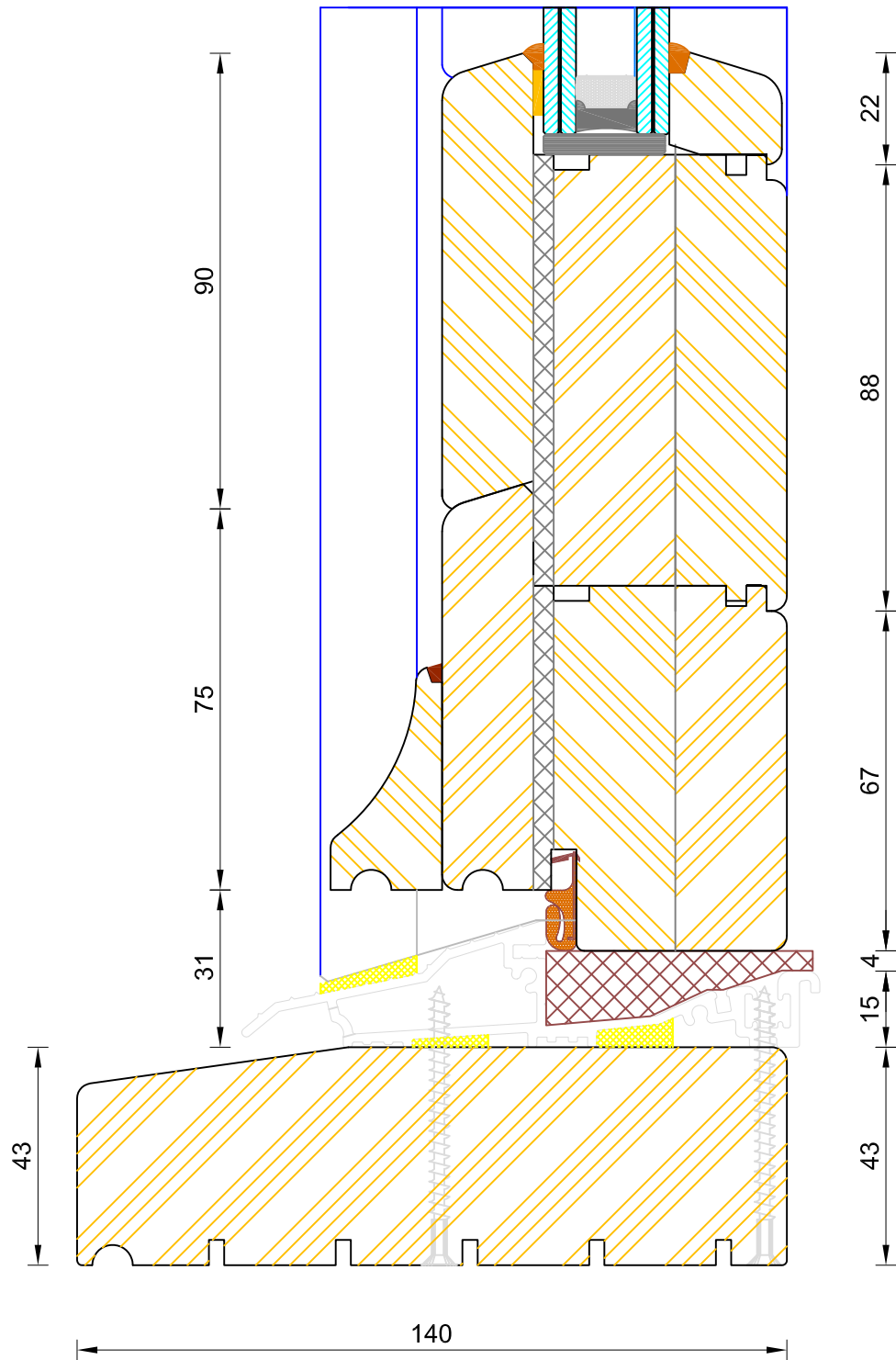

ALL DIMENSIONS IN mm		ORIGINAL PLOT A3 SIZE (297x420)					
SCALE	GENERAL TOLERANCE	MATERIAL	S. Felczak	J. Stebelski	27.01.2011		
1 : 1	+ 2	Timber	E.Pech		07.02.2008		
TITLE		DRAWN BY		CHECKED	DATE	ISSUE	
FLUSH DOOR OPEN IN Standard Threshold (140x43mm)		DWG NO.		1112		SHT	1

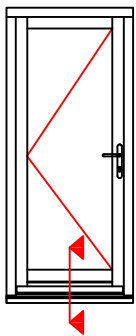
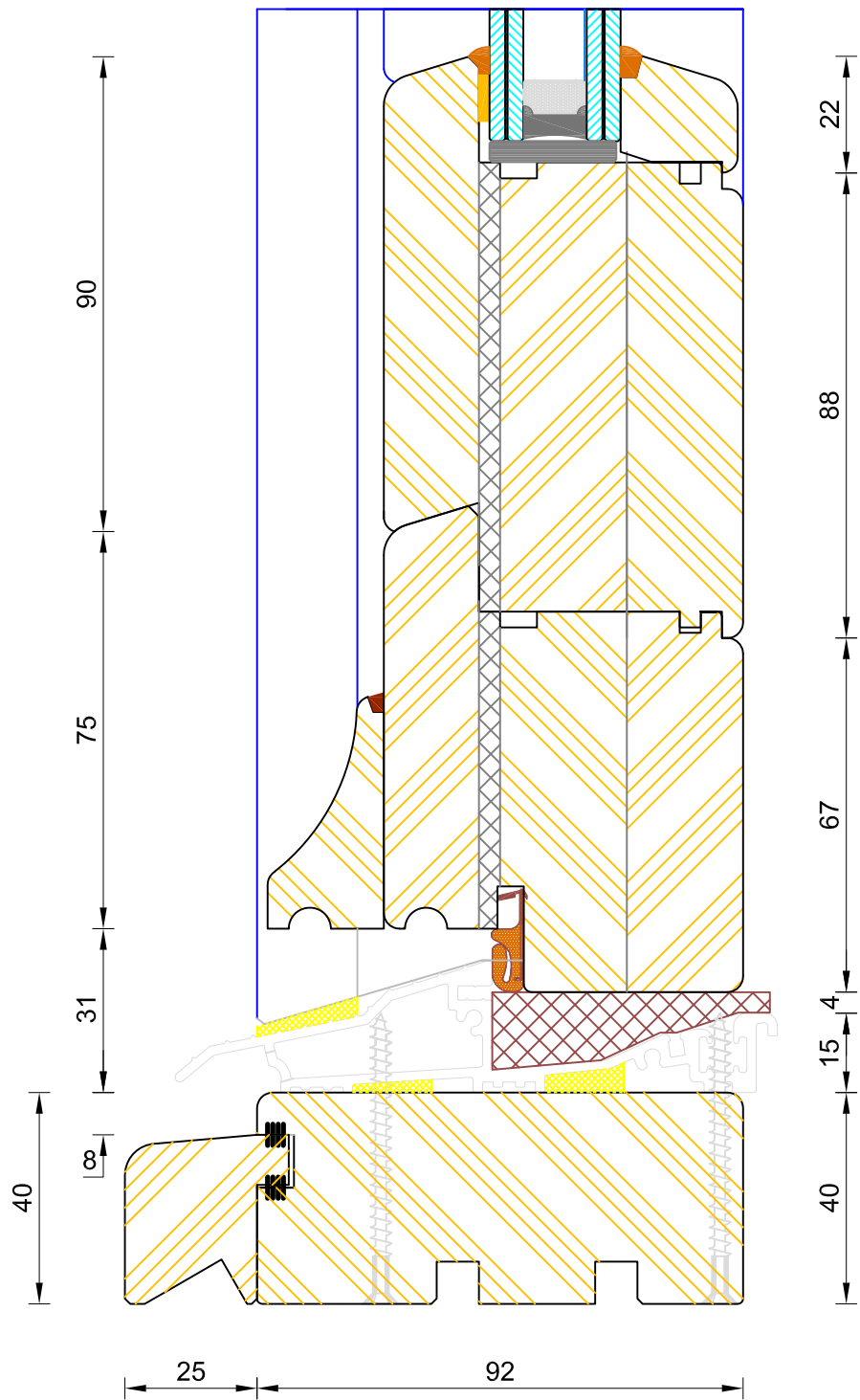

CILL EXTENSION - available options: 25mm (117mm o/a) / 47mm (139mm o/a) / 62mm (154mm o/a) / 87mm (179mm o/a) / 114mm (206mm o/a) / 125mm (217mm o/a) / 140mm (232mm o/a)

NOTE: Cill Extensions should be supported from underneath; the maximum overhang over Brick / Blockwork for cill extension should not exceed 25mm in order to avoid damage when stepped on. Warranties are invalidated when fitted with overhang in excess to that.

If not otherwise stated, Hardwood Threshold will be painted the same colour as Frame.

ALL DIMENSIONS IN mm		ORIGINAL PLOT A3 SIZE (297x420)					
SCALE	GENERAL TOLERANCE	MATERIAL					
1 : 1	+ 2	Timber		S. Felczak	J. Stebelski	27.01.2011	
TITLE				E.Pech		06.08.2007	0
FLUSH DOOR OPEN IN Site Coupling Threshold (92x43mm)				DRAWN BY	CHECKED	DATE	ISSUE
				DWG NO. 1113			SHT 1

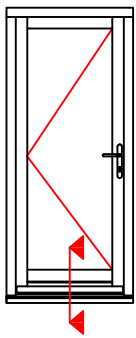
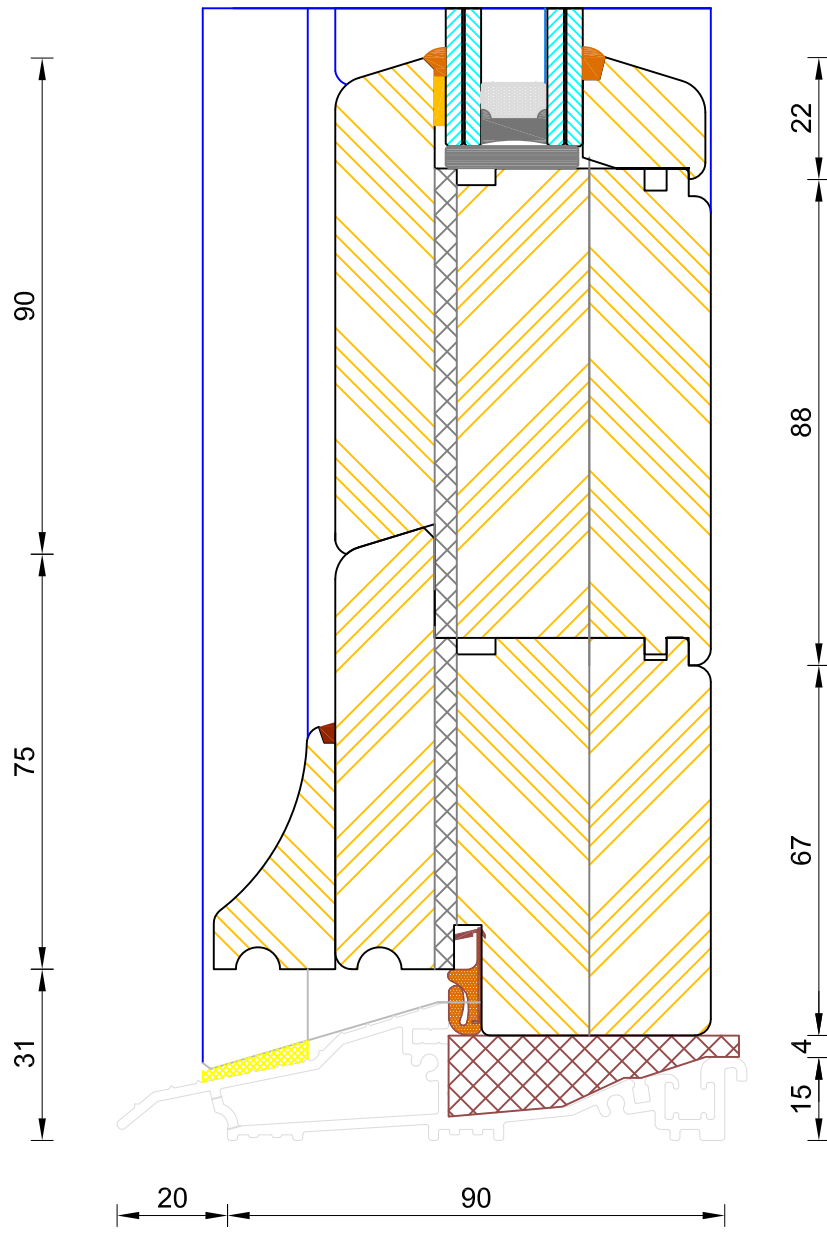

ALL DIMENSIONS IN mm		ORIGINAL PLOT A3 SIZE (297x420)					
SCALE	GENERAL TOLERANCE	MATERIAL					
1 : 1	+ 2	Timber		S. Felczak	J. Stebelski	27.01.2011	
TITLE				E.Pech		06.08.2007	0
FLUSH DOOR OPEN IN Standard Mobility Threshold			DRAWN BY	CHECKED	DATE	ISSUE	
			DWG NO.	1114		SHT	1

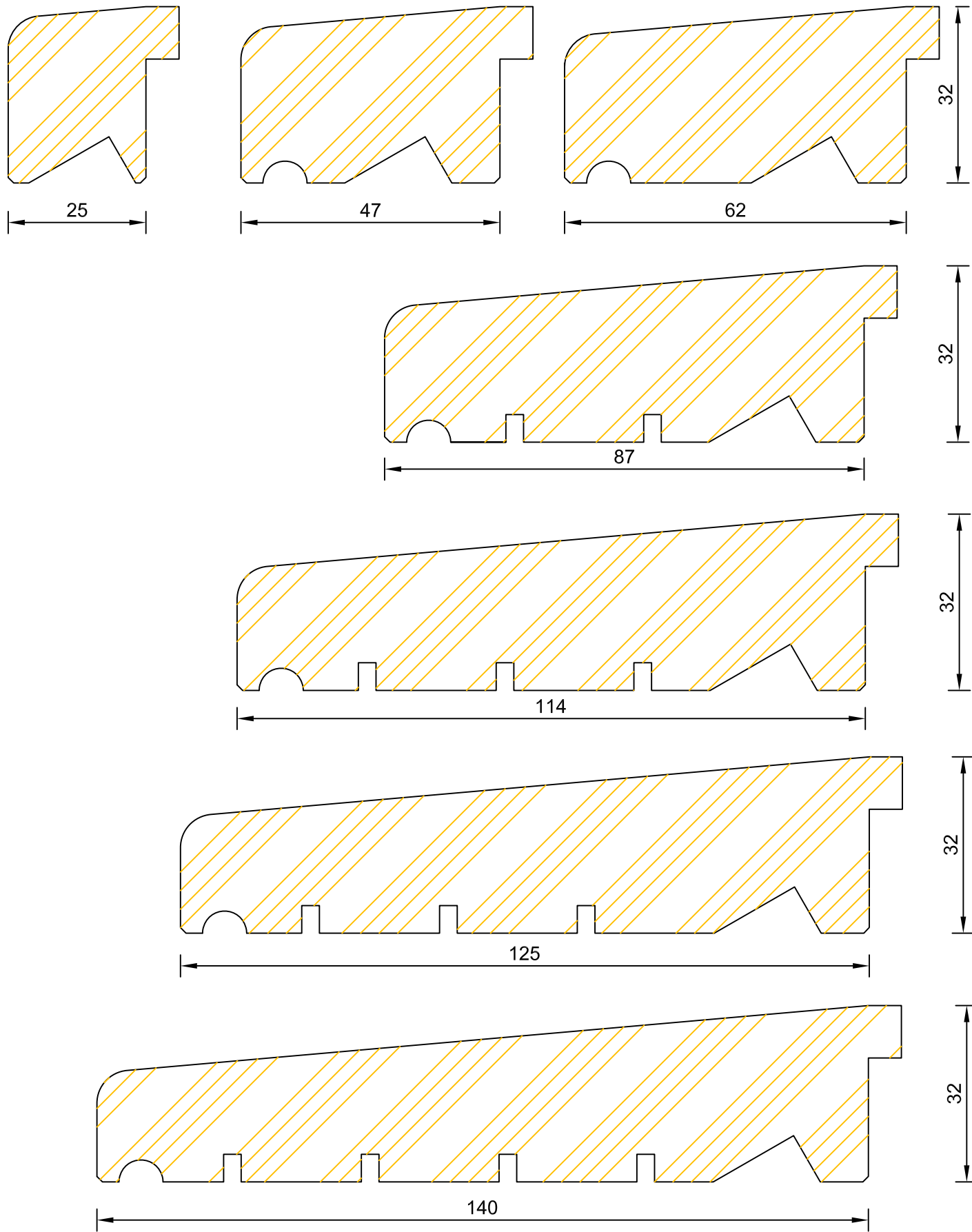

ALL DIMENSIONS IN mm ORIGINAL PLOT A4 SIZE (210x297)

SCALE 1 : 1	GENERAL TOLERANCE + 2	MATERIAL Timber
----------------	--------------------------	--------------------

TITLE
FLUSH DOOR OPEN IN
Cill Extension Details

S. Felczak	J. Stebelski	27.01.2011	
E.Pech		06.08.2007	0
DRAWN BY	CHECKED	DATE	ISSUE
DWG NO.	1101		SHT 1

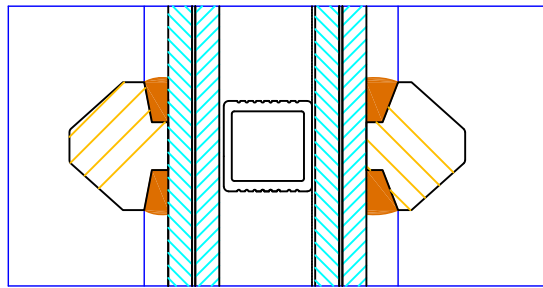

16

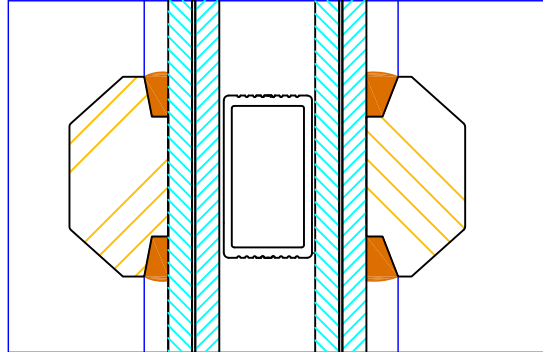

25

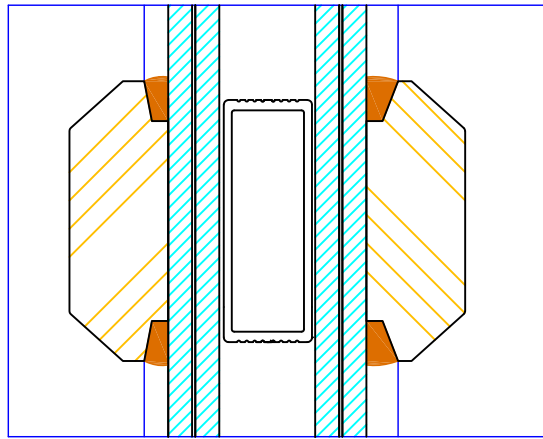

35

60 (varies min 60/ max 137mm)

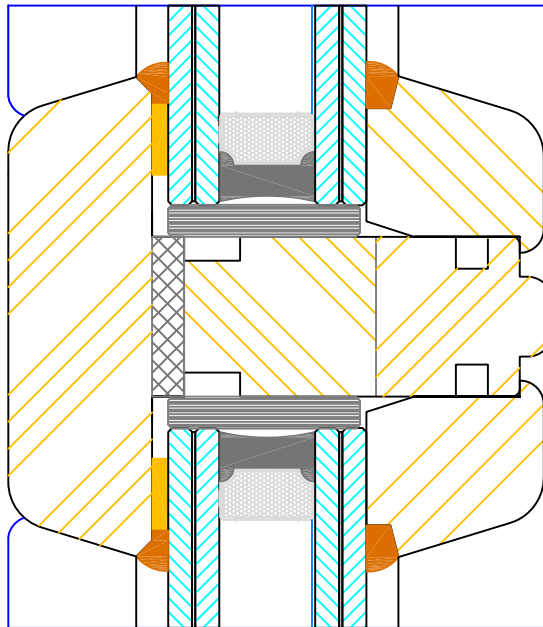

22
16
22

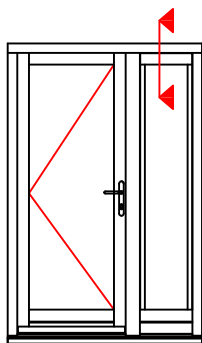
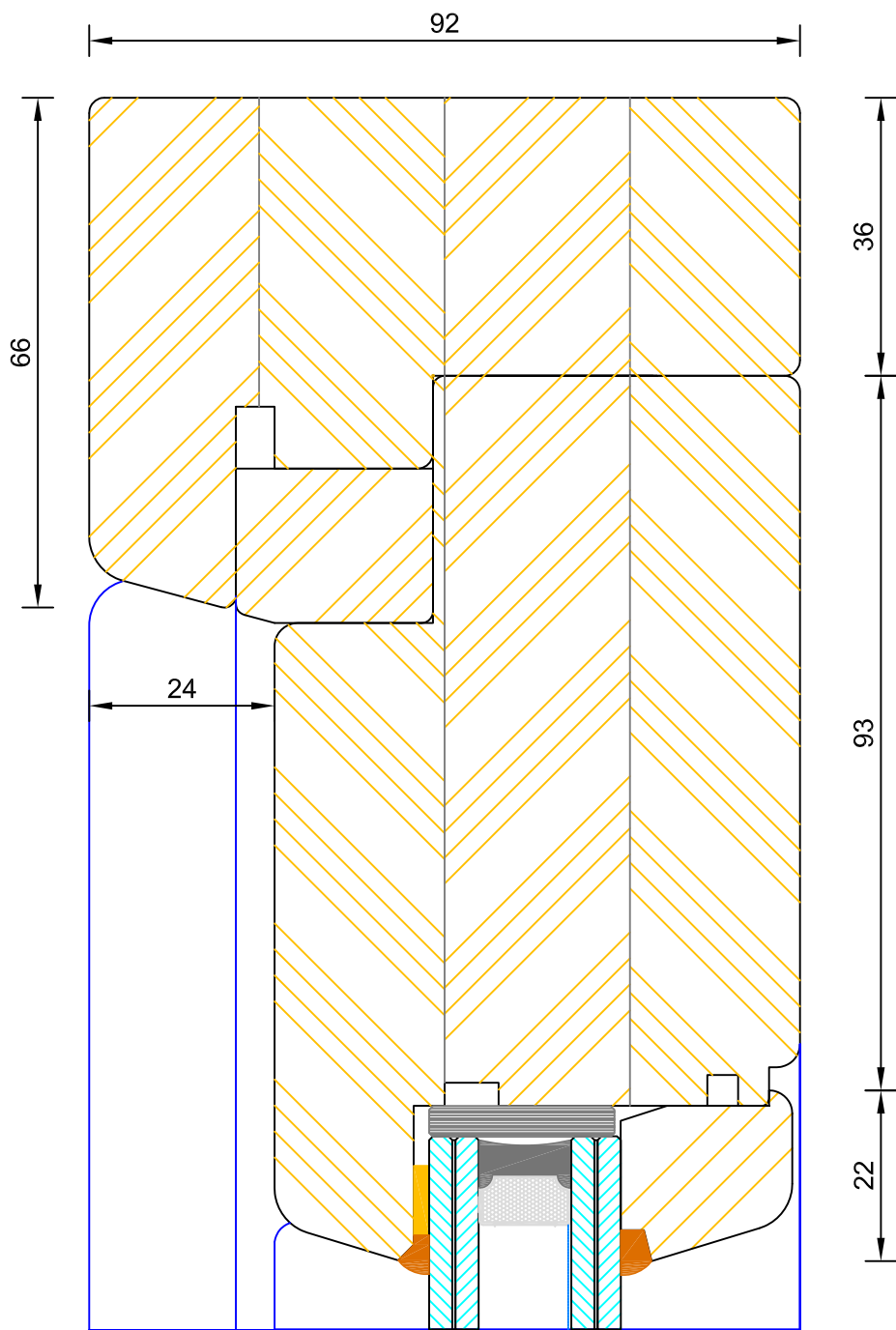

ALL DIMENSIONS IN mm		ORIGINAL PLOT A4 SIZE (210x297)					
SCALE	GENERAL TOLERANCE	MATERIAL					
1 : 1	+ 2	Timber		S. Felczak	J. Stebelski	27.01.2011	
				E.Pech		06.08.2007	0
TITLE		FLUSH DOOR OPEN IN Head Section Sidelight		DRAWN BY	CHECKED	DATE	ISSUE
				DWG NO. 1103			SHT 1

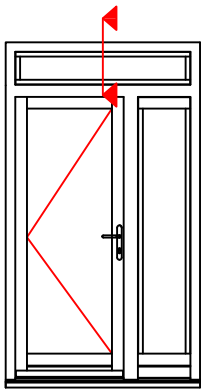
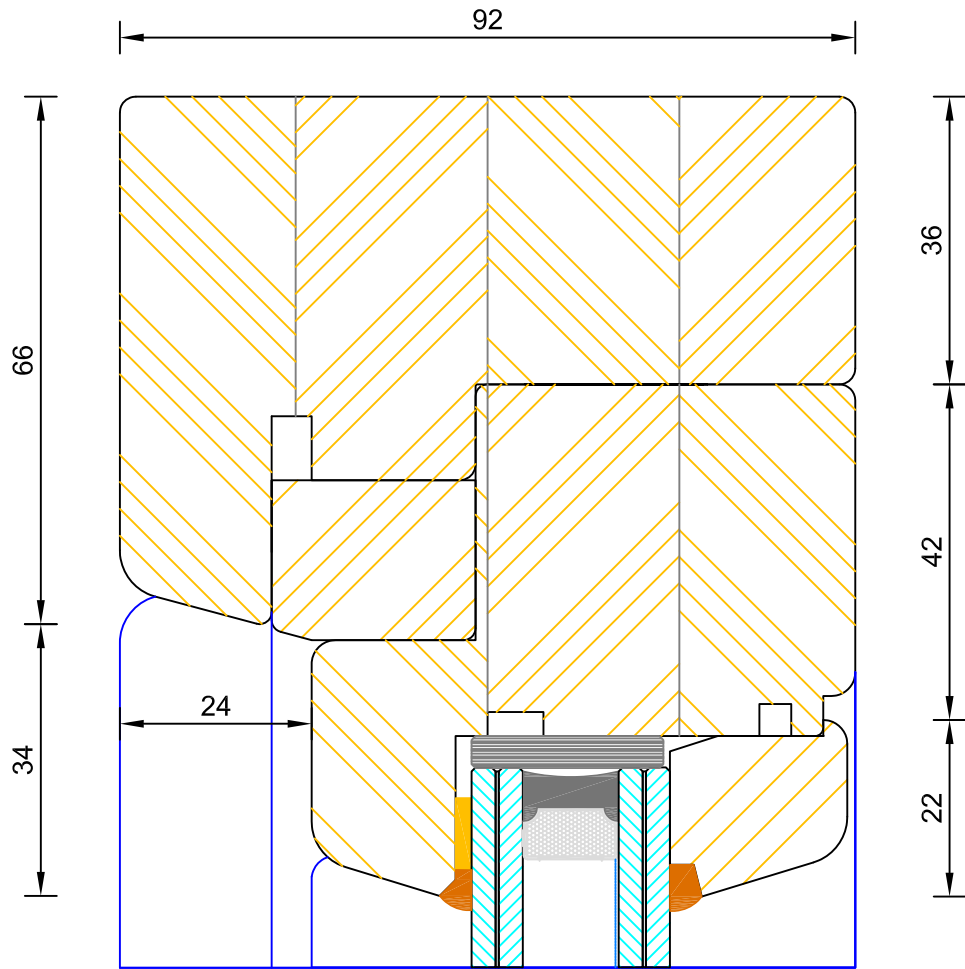

ALL DIMENSIONS IN mm		ORIGINAL PLOT A4 SIZE (210x297)					
SCALE	GENERAL TOLERANCE	MATERIAL					
1 : 1	+ 2	Timber		S. Felczak	J. Stebelski	27.01.2011	
TITLE				E.Pech		06.08.2007	0
FLUSH DOOR OPEN IN Head Section Fanlight				DRAWN BY	CHECKED	DATE	ISSUE
				DWG NO. 1104			SHT 1

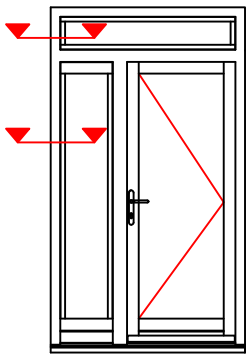
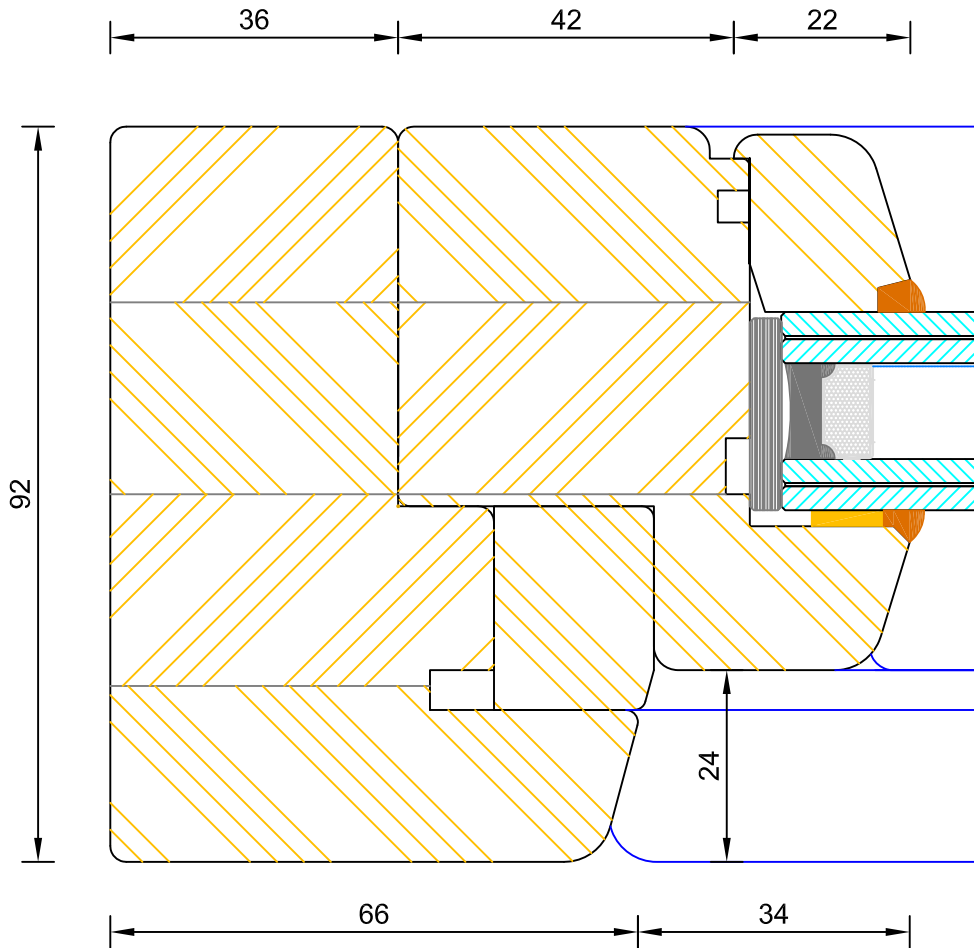

ALL DIMENSIONS IN mm		ORIGINAL PLOT A4 SIZE (210x297)					
SCALE	GENERAL TOLERANCE	MATERIAL					
1 : 1	+ 2	Timber		S. Felczak	J. Stebelski	27.01.2011	
TITLE				E.Pech		06.08.2007	0
FLUSH DOOR OPEN IN Jamb Section Fanlight / Sidelight				DRAWN BY	CHECKED	DATE	ISSUE
				DWG NO. 1105			SHT 1

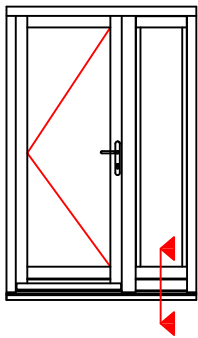
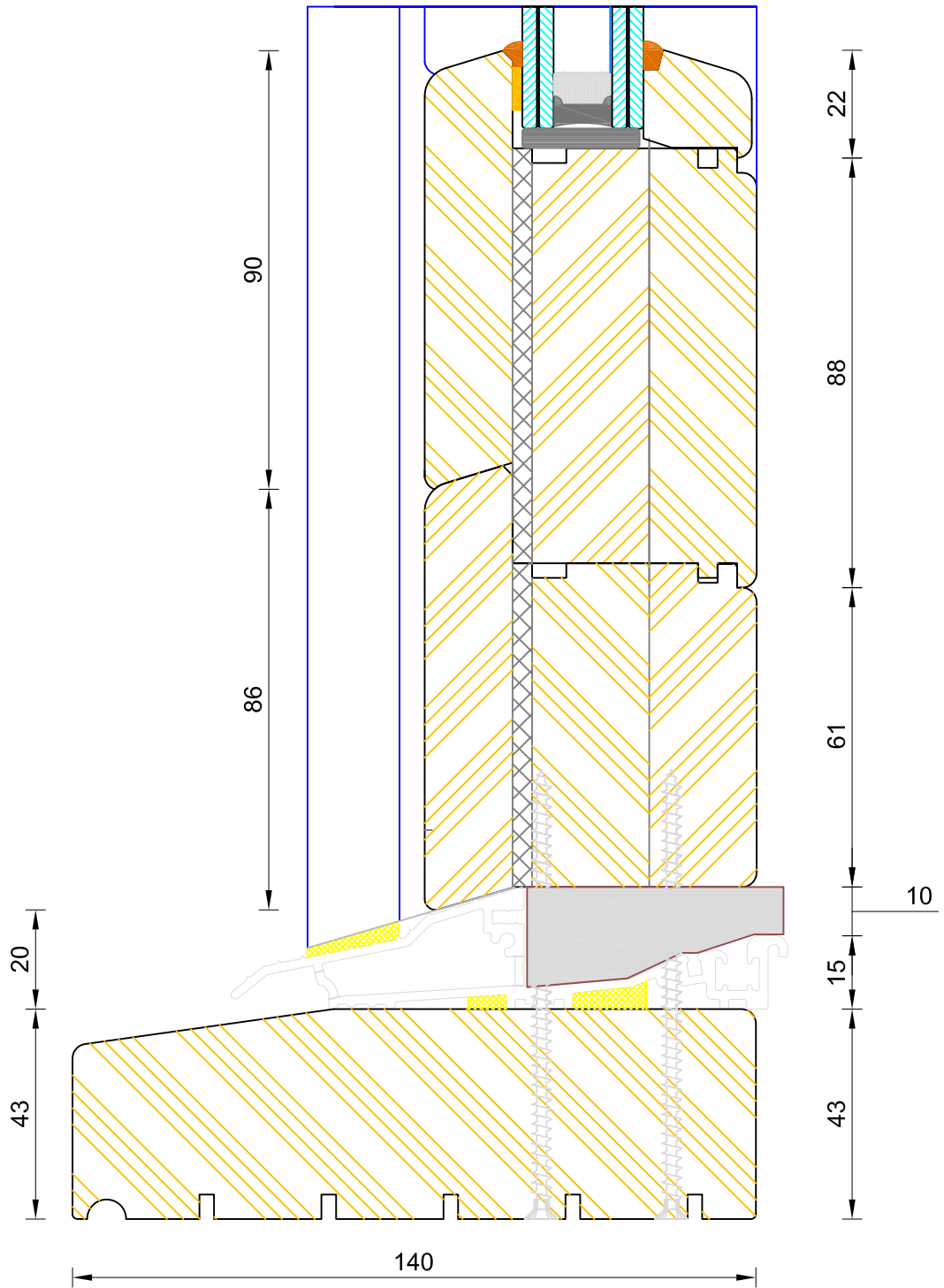

ALL DIMENSIONS IN mm		ORIGINAL PLOT A3 SIZE (297x420)					
SCALE	GENERAL TOLERANCE	MATERIAL	S. Felczak	J. Stebelski	27.01.2011		
1 : 1	+ 2	Timber	E.Pech		07.02.2008		
TITLE		DRAWN BY		CHECKED	DATE	ISSUE	
FLUSH DOOR OPEN IN Standard Threshold Silight (made as 1 unit; 140x43mm)		DWG NO.				SHT	
		1106				1	

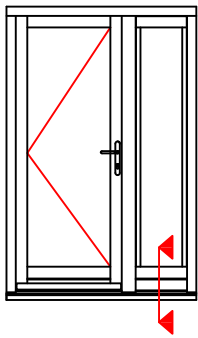
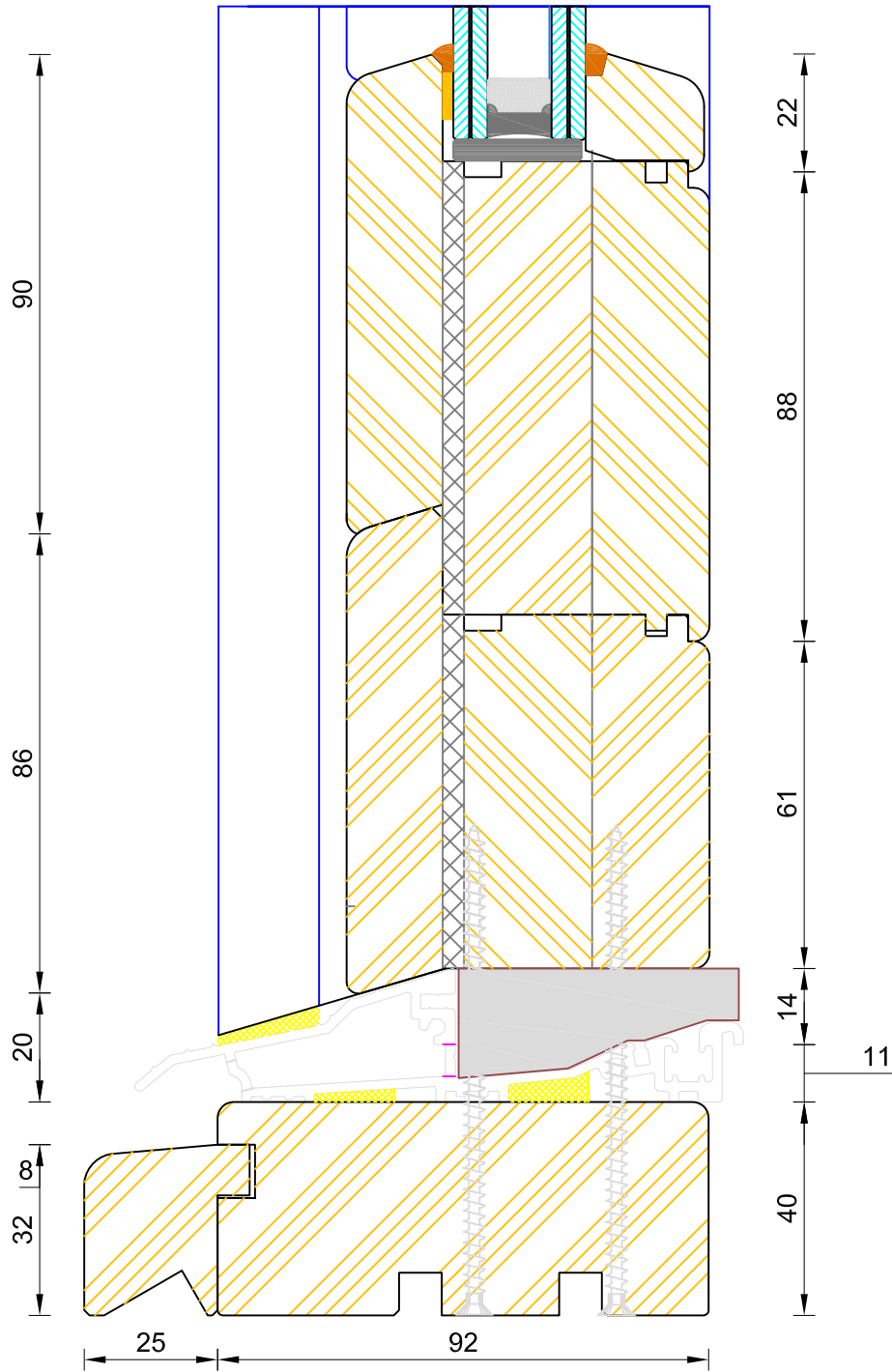

CILL EXTENSION - available options: 25mm (117mm o/a) / 47mm (139mm o/a) / 62mm (154mm o/a) / 87mm (179mm o/a) / 114mm (206mm o/a) / 125mm (217mm o/a) / 140mm (232mm o/a)

NOTE: Cill Extensions should be supported from underneath; the maximum overhang over Brick / Blockwork for cill extension should not exceed 25mm in order to avoid damage when stepped on. Warranties are invalidated when fitted with overhang in excess to that.

If not otherwise stated, Hardwood Threshold will be painted the same colour as Frame.

ALL DIMENSIONS IN mm		ORIGINAL PLOT A3 SIZE (297x420)					
SCALE	GENERAL TOLERANCE	MATERIAL					
1 : 1	+ 2	Timber		S. Felczak	J. Stebelski	27.01.2011	
TITLE				E.Pech		06.08.2007	0
FLUSH DOOR OPEN IN Site Coupling Threshold Sidelight (92x40mm)				DRAWN BY	CHECKED	DATE	ISSUE
				DWG NO. 1107			SHT 1

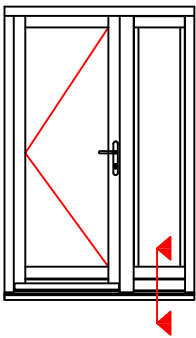
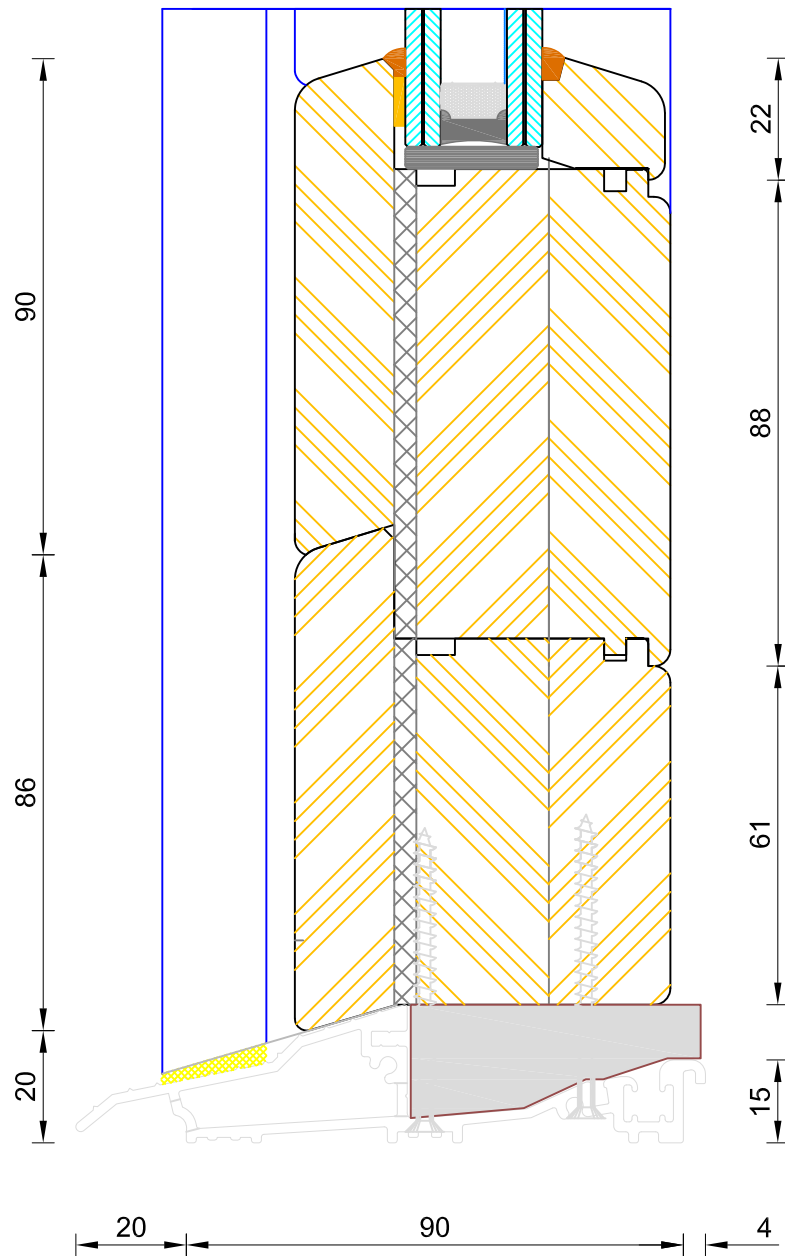

ALL DIMENSIONS IN mm		ORIGINAL PLOT A3 SIZE (297x420)					
SCALE	GENERAL TOLERANCE	MATERIAL					
1 : 1	+ 2	Timber		S. Felczak	J. Stebelski	27.01.2011	
				E.Pech		06.08.2007	0
TITLE				DRAWN BY	CHECKED	DATE	ISSUE
FLUSH DOOR OPEN IN Standard Mobility Threshold Sidelight (made as 1 unit)				DWG NO.	1108		SHT 1

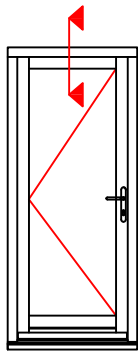
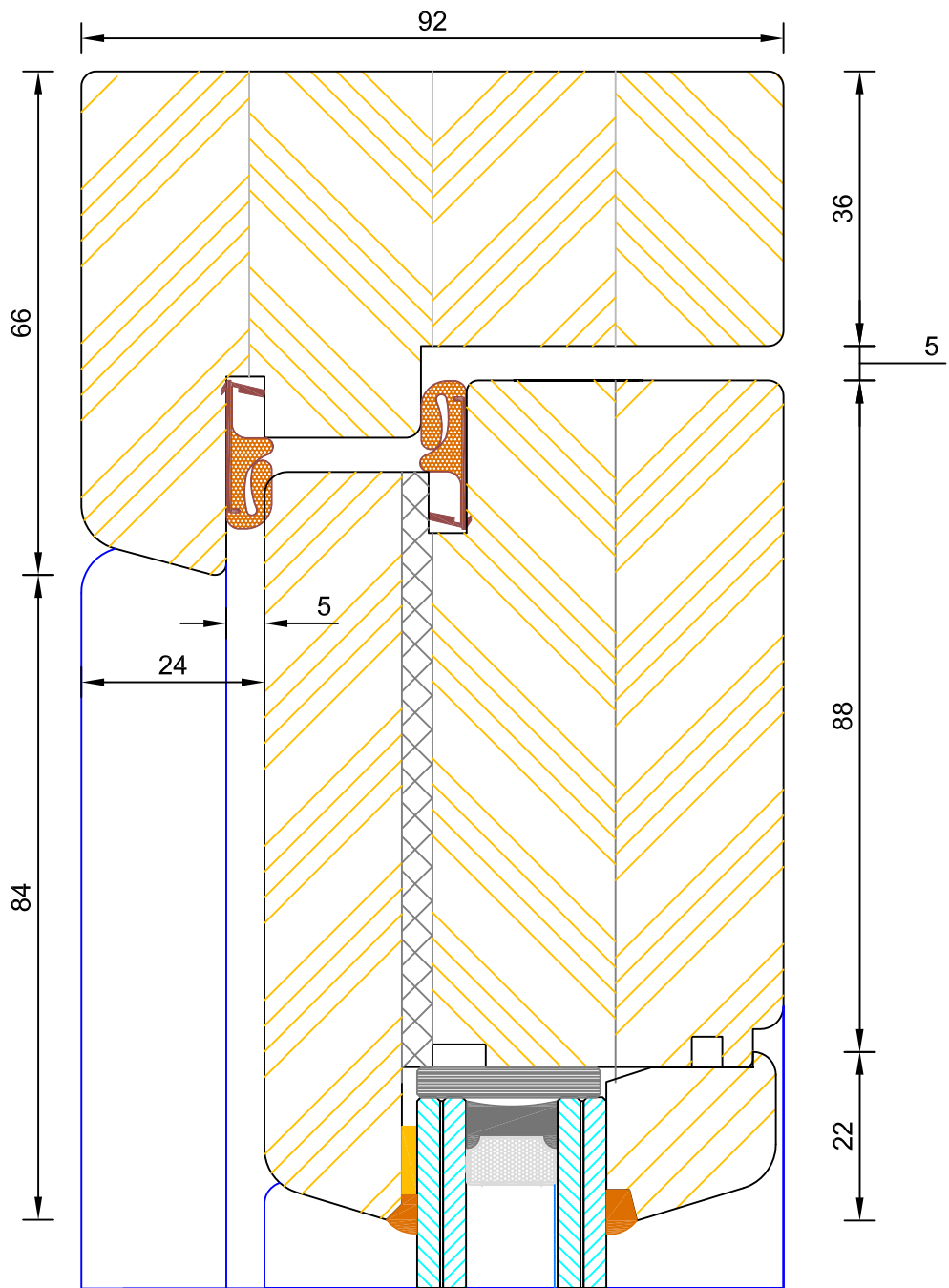

ALL DIMENSIONS IN mm ORIGINAL PLOT A4 SIZE (210x297)

SCALE
1 : 1

GENERAL
TOLERANCE
+ 2

MATERIAL
Timber

S. Felczak
E.Pech

J. Stebelski

27.01.2011
06.08.2007

0

TITLE
FLUSH DOOR OPEN IN
Head Section (Frame & Leaf)

DRAWN BY
DWG NO.

CHECKED
1109

DATE
1

ISSUE
SHT
1

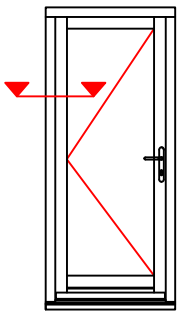
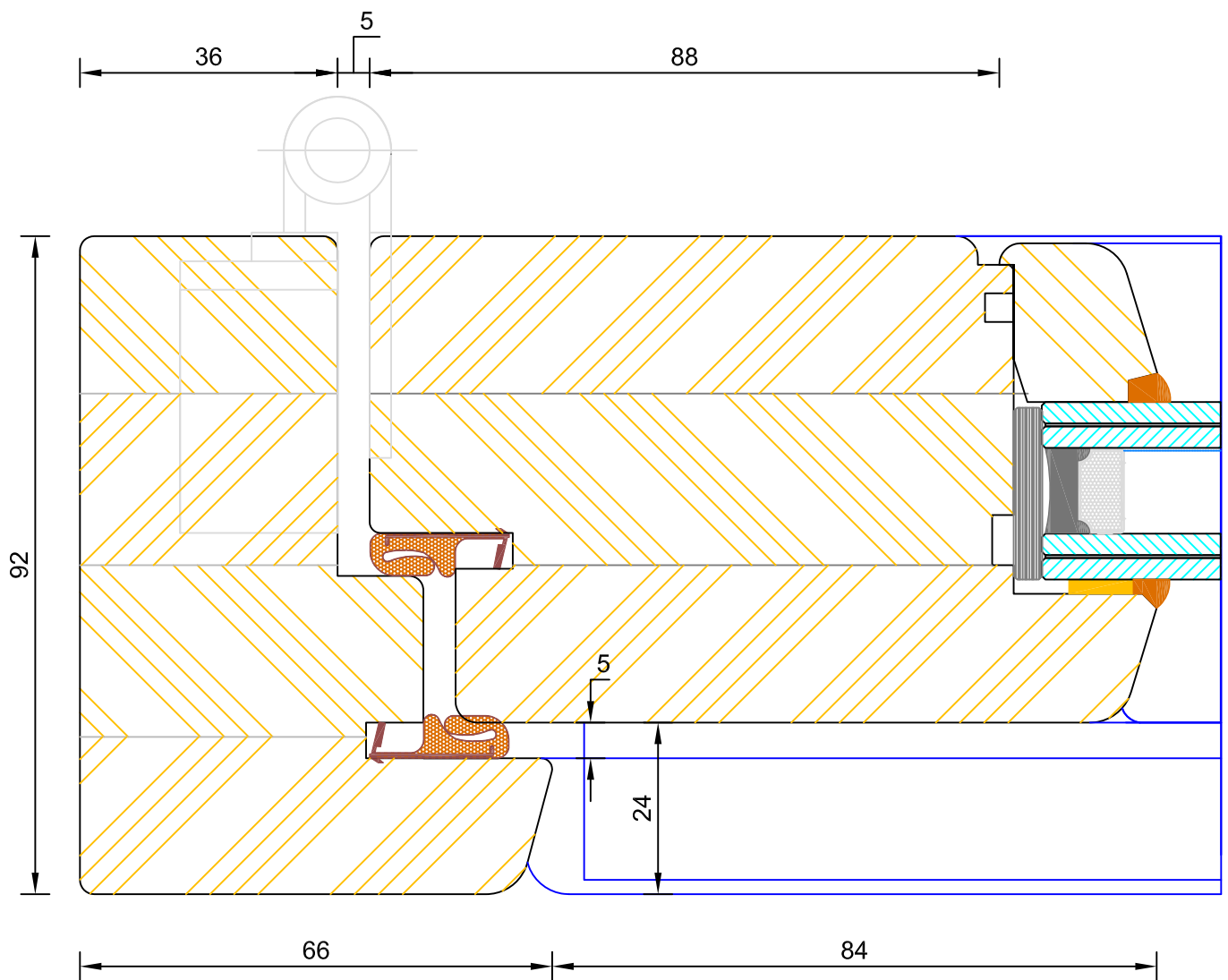

ALL DIMENSIONS IN mm		ORIGINAL PLOT A4 SIZE (210x297)					
SCALE	GENERAL TOLERANCE	MATERIAL					
1 : 1	+ 2	Timber		S. Felczak	J. Stebelski	27.01.2011	
				E.Pech		06.08.2007	0
TITLE				DRAWN BY	CHECKED	DATE	ISSUE
FLUSH DOOR OPEN IN Jamb Section Frame & Leaf (Hinge Side)				DWG NO.	1110		SHT 1

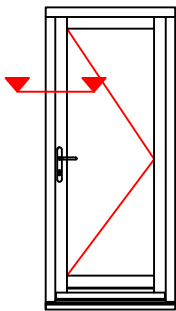
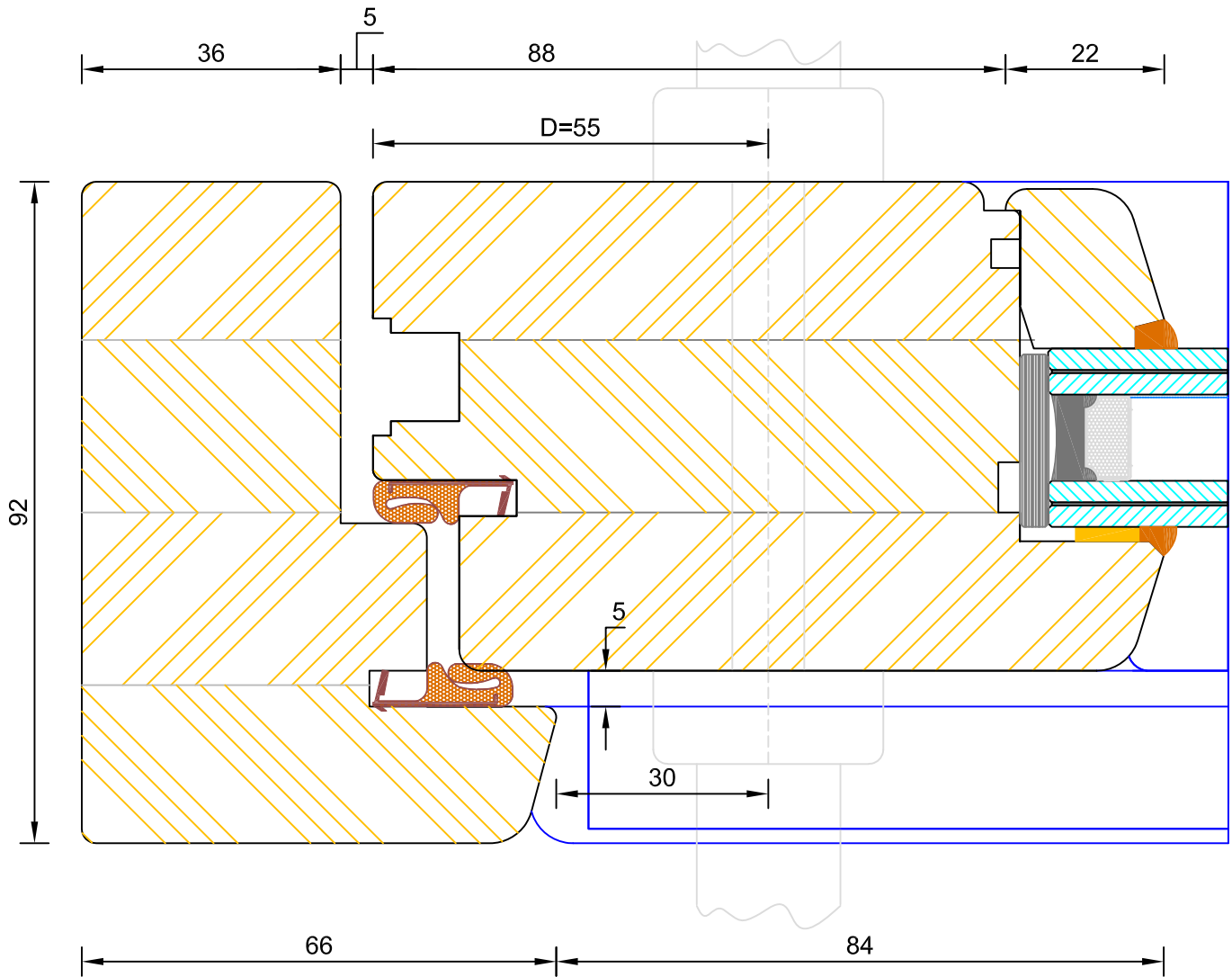

ALL DIMENSIONS IN mm		ORIGINAL PLOT A4 SIZE (210x297)					
SCALE	GENERAL TOLERANCE	MATERIAL					
1 : 1	+ 2	Timber		S. Felczak	J. Stebelski	27.01.2011	
TITLE				E.Pech		06.08.2007	0
FLUSH DOOR OPEN IN Jamb Section Frame & Leaf (Handle Side)				DRAWN BY	CHECKED	DATE	ISSUE
				DWG NO. 1111			SHT 1

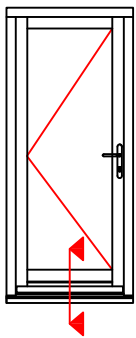
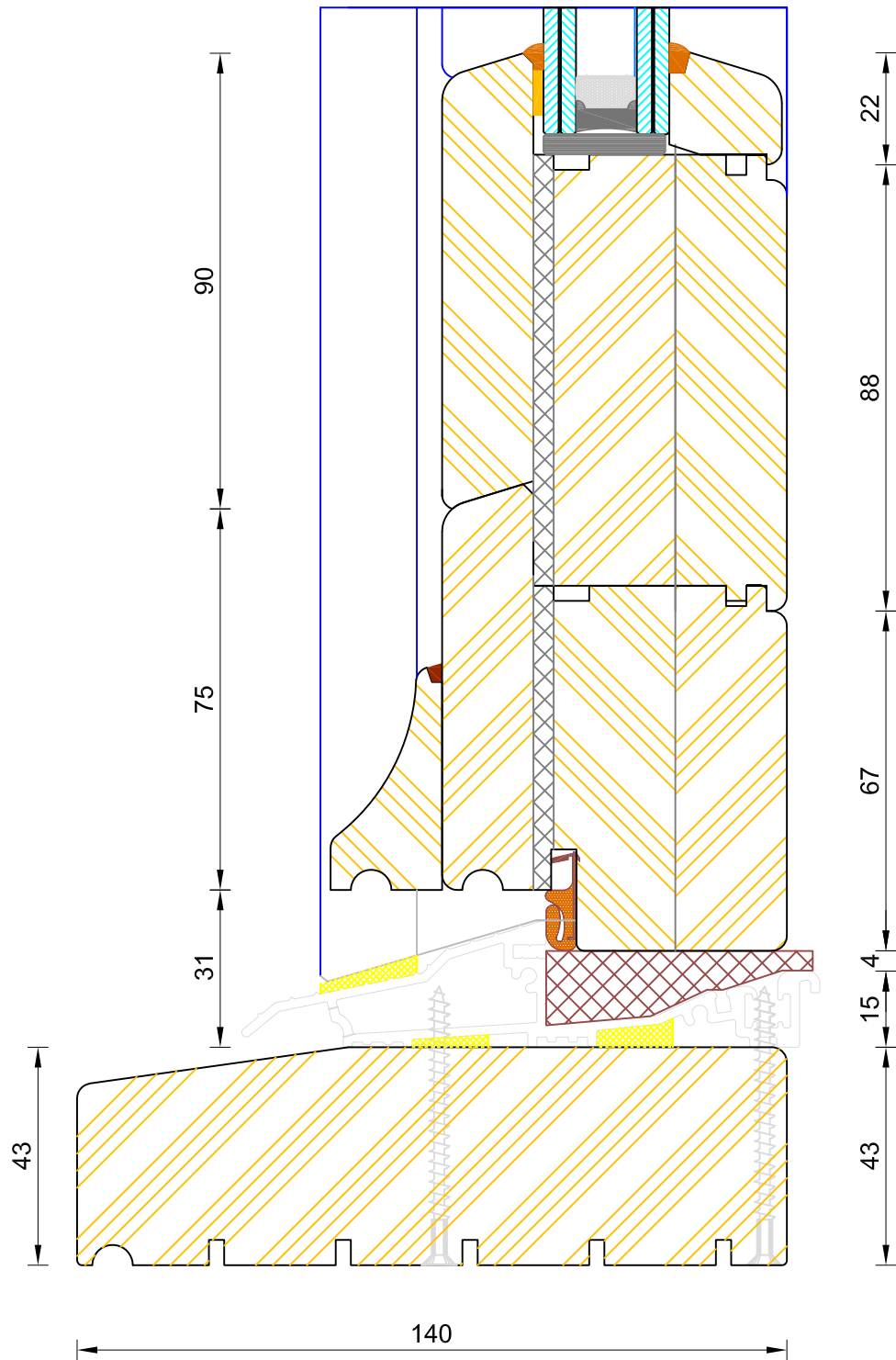

ALL DIMENSIONS IN mm		ORIGINAL PLOT A3 SIZE (297x420)					
SCALE	GENERAL TOLERANCE	MATERIAL	S. Felczak	J. Stebelski	27.01.2011		
1 : 1	+ 2	Timber	E.Pech		07.02.2008		
TITLE		DRAWN BY		CHECKED	DATE	ISSUE	
FLUSH DOOR OPEN IN Standard Threshold (140x43mm)		DWG NO.		1112		SHT	0
						1	

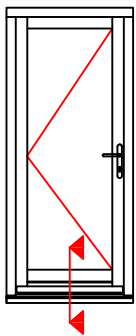
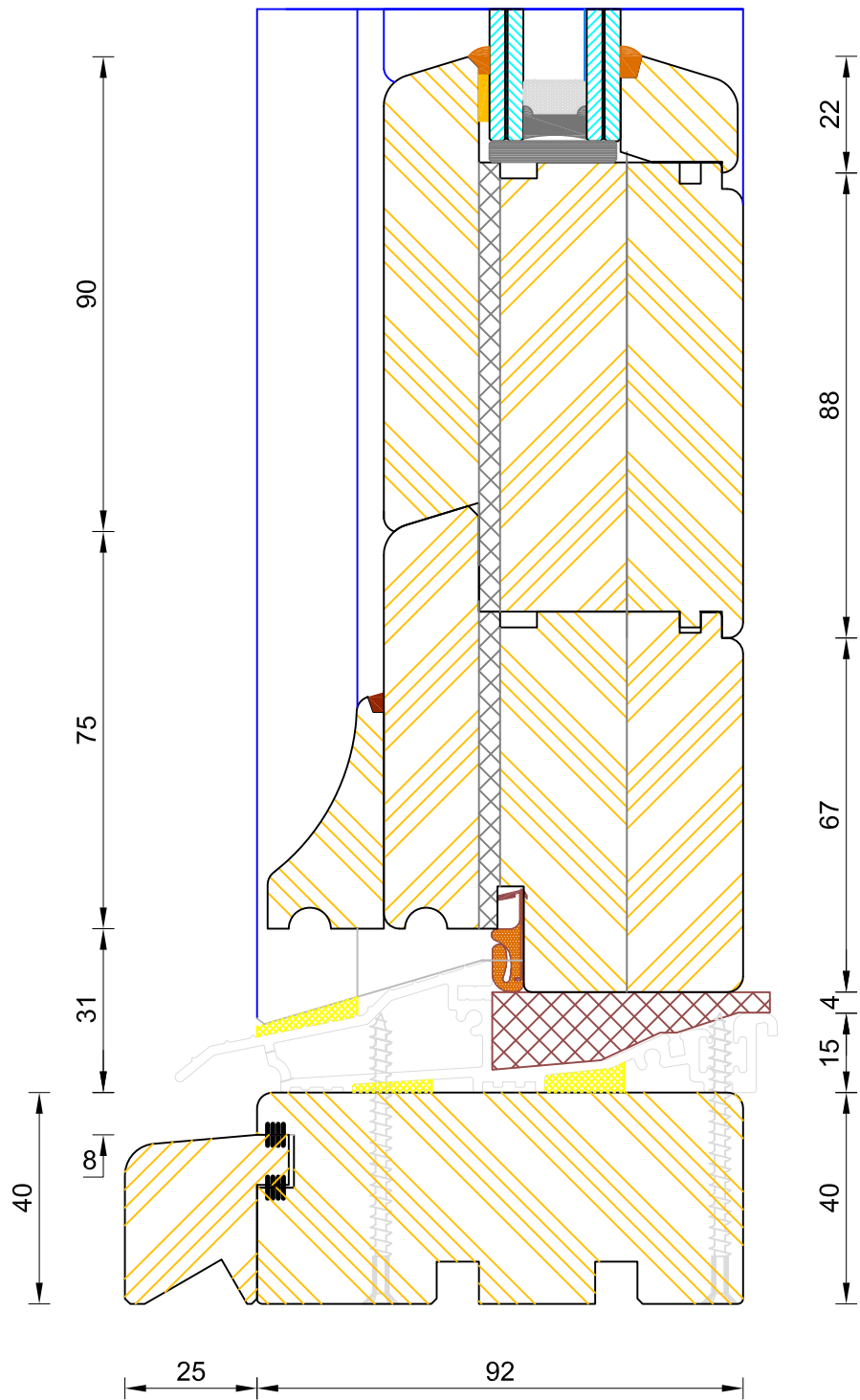

CILL EXTENSION - available options: 25mm (117mm o/a) / 47mm (139mm o/a) / 62mm (154mm o/a) / 87mm (179mm o/a) / 114mm (206mm o/a) / 125mm (217mm o/a) / 140mm (232mm o/a)

NOTE: Cill Extensions should be supported from underneath; the maximum overhang over Brick / Blockwork for cill extension should not exceed 25mm in order to avoid damage when stepped on. Warranties are invalidated when fitted with overhang in excess to that.

If not otherwise stated, Hardwood Threshold will be painted the same colour as Frame.

ALL DIMENSIONS IN mm		ORIGINAL PLOT A3 SIZE (297x420)					
SCALE	GENERAL TOLERANCE	MATERIAL					
1 : 1	+ 2	Timber		S. Felczak	J. Stebelski	27.01.2011	
TITLE				E.Pech		06.08.2007	0
FLUSH DOOR OPEN IN Site Coupling Threshold (92x43mm)				DRAWN BY	CHECKED	DATE	ISSUE
				DWG NO. 1113			SHT 1

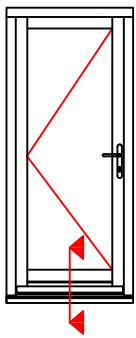
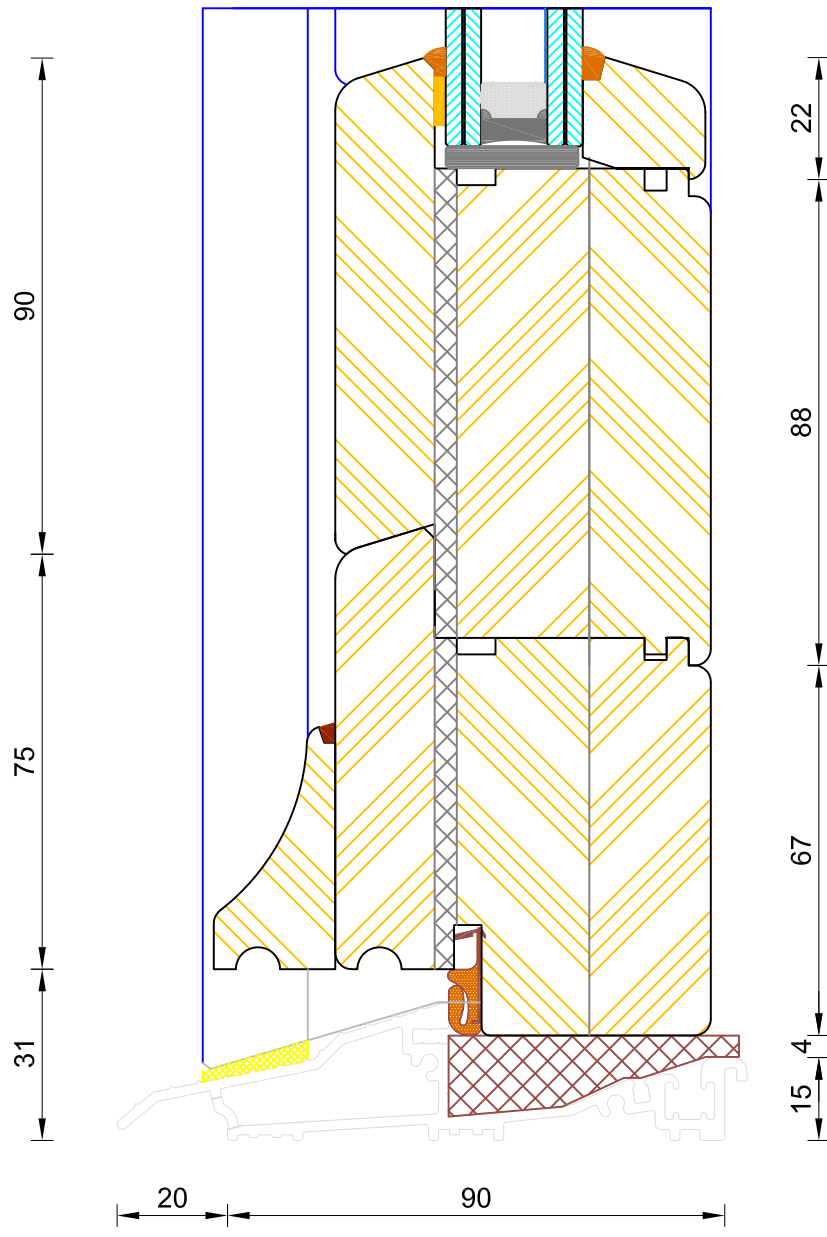

ALL DIMENSIONS IN mm		ORIGINAL PLOT A3 SIZE (297x420)					
SCALE	GENERAL TOLERANCE	MATERIAL					
1 : 1	+ 2	Timber		S. Felczak	J. Stebelski	27.01.2011	
TITLE				E.Pech		06.08.2007	0
FLUSH DOOR OPEN IN Standard Mobility Threshold			DRAWN BY	CHECKED	DATE	ISSUE	
			DWG NO.	1114		SHT	1



Paint, Stains and Preservative Specification

Standard Specification	Options																				
<p>Paint Coatings</p> <table border="1" data-bbox="979 427 1214 1122"> <tr> <td>Impregnation</td> <td>GORI 356 GORI 642 (OAK) GORI ANTI STAIN AQUA 5200-1 (SOFTWOOD/HARDWOOD)</td> </tr> <tr> <td>Primers</td> <td>GORI 990 FLEX</td> </tr> <tr> <td>Joint & Grain Sealer</td> <td>GORI 641 (SOFTWOOD) GORI 643 (HARDWOOD/OAK)</td> </tr> <tr> <td>Intermediate Coat</td> <td>GORI 660 + PAINT COLOUR</td> </tr> <tr> <td>Finish Coat</td> <td></td> </tr> </table> <p>Water-borne, spray applied coating system is used for both paints and stains. Applied coating thickness: wet: 300-450µm dry: 150-200µm Half gloss level finish</p> <p>Preservative: Water based impregnation in a dipping process Joints and end grain are sealed with v-joint sealer – Gori 990 Flex</p>	Impregnation	GORI 356 GORI 642 (OAK) GORI ANTI STAIN AQUA 5200-1 (SOFTWOOD/HARDWOOD)	Primers	GORI 990 FLEX	Joint & Grain Sealer	GORI 641 (SOFTWOOD) GORI 643 (HARDWOOD/OAK)	Intermediate Coat	GORI 660 + PAINT COLOUR	Finish Coat		<p>Stain Coatings</p> <table border="1" data-bbox="943 1211 1214 1973"> <tr> <td>Impregnation</td> <td>GORI 356 GORI 646 OR 615</td> </tr> <tr> <td>Primers</td> <td>GORI 990 FLEX</td> </tr> <tr> <td>Joint & Grain Sealer</td> <td>GORI 892 (SOFTWOOD/HARDWOOD) GORI 892+ GORI 643 (OAK)</td> </tr> <tr> <td>Intermediate Coat</td> <td>GORI 660-30 + COLOUR CODE FROM SWATCH SAMPLES FOLLOWED BY COLOUR DESCRIPTION I.E. 5063 LIGHT PINE</td> </tr> <tr> <td>Finish Coat</td> <td></td> </tr> </table> <p>Water-borne, spray applied coating system is used for both paints and stains. Applied coating thickness: wet: 300-450µm dry: 150-200µm Half gloss level finish</p>	Impregnation	GORI 356 GORI 646 OR 615	Primers	GORI 990 FLEX	Joint & Grain Sealer	GORI 892 (SOFTWOOD/HARDWOOD) GORI 892+ GORI 643 (OAK)	Intermediate Coat	GORI 660-30 + COLOUR CODE FROM SWATCH SAMPLES FOLLOWED BY COLOUR DESCRIPTION I.E. 5063 LIGHT PINE	Finish Coat	
Impregnation	GORI 356 GORI 642 (OAK) GORI ANTI STAIN AQUA 5200-1 (SOFTWOOD/HARDWOOD)																				
Primers	GORI 990 FLEX																				
Joint & Grain Sealer	GORI 641 (SOFTWOOD) GORI 643 (HARDWOOD/OAK)																				
Intermediate Coat	GORI 660 + PAINT COLOUR																				
Finish Coat																					
Impregnation	GORI 356 GORI 646 OR 615																				
Primers	GORI 990 FLEX																				
Joint & Grain Sealer	GORI 892 (SOFTWOOD/HARDWOOD) GORI 892+ GORI 643 (OAK)																				
Intermediate Coat	GORI 660-30 + COLOUR CODE FROM SWATCH SAMPLES FOLLOWED BY COLOUR DESCRIPTION I.E. 5063 LIGHT PINE																				
Finish Coat																					
<p>Finish Colours</p> <p>Please enquire for specific RAL colour</p>	<p>Colour swatches are available on specialist Bereco branded colours</p> <p>Please enquire for specific BS or F&B colours</p>																				
<p>Standard Paint Colours:</p> <ul style="list-style-type: none"> Range of RAL Colours Range of BS 4800 Colours 	<p>Standard Stain Colours:</p> <ul style="list-style-type: none"> Light Pine Pine Antique Pine Afrosoma Chestnut Light Chestnut Light Mahogany Light Cherry <p>Colour swatches are available on stains in all timber types</p>																				
<p>Exclusive Paint Colours (Optional):</p> <ul style="list-style-type: none"> Parlour Linen Parchment French Green London Dust 	<p>Standard Stain Colours:</p> <ul style="list-style-type: none"> Oak Rich Mahogany Walnut Mahogany Teak Cherry Dark Oak Rosewood 																				

Casement Windows

Casement Lipped - Traditional

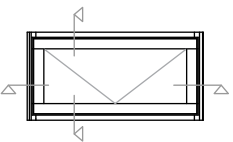

Stepped Trickle Vent
concealed by Head Drip

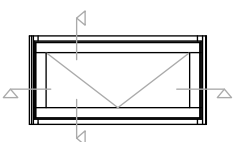
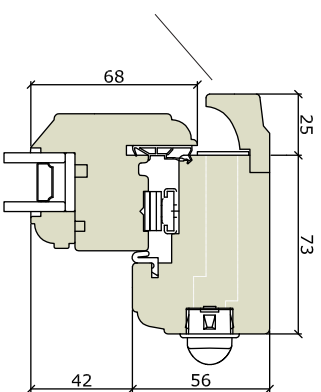

Stepped Trickle Vent
concealed by Head Drip

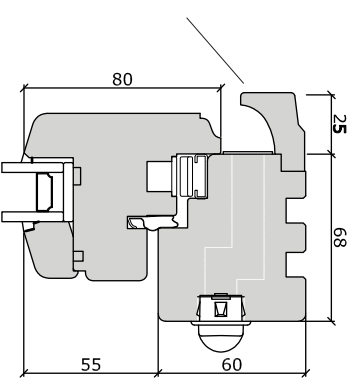

Casement Lipped - Contemporary

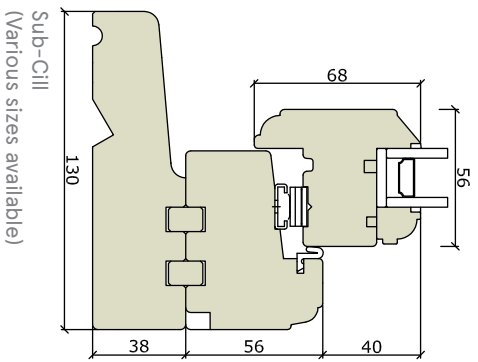

Sub-Cill
(Various sizes available)

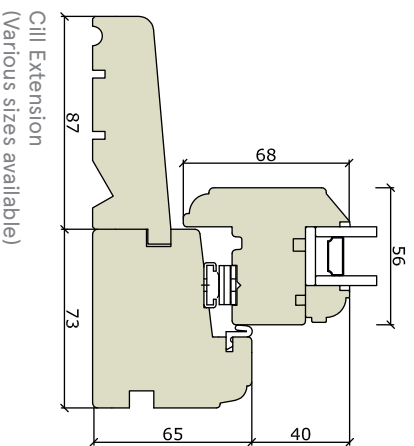

Cill Extension
(Various sizes available)

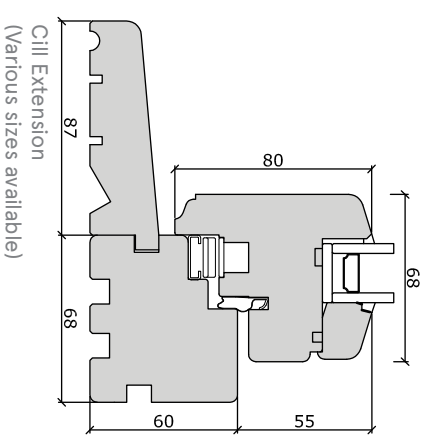
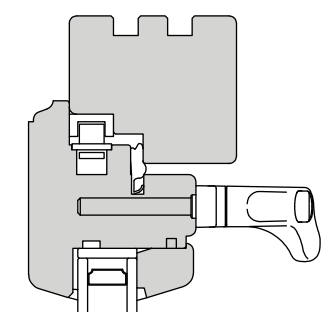
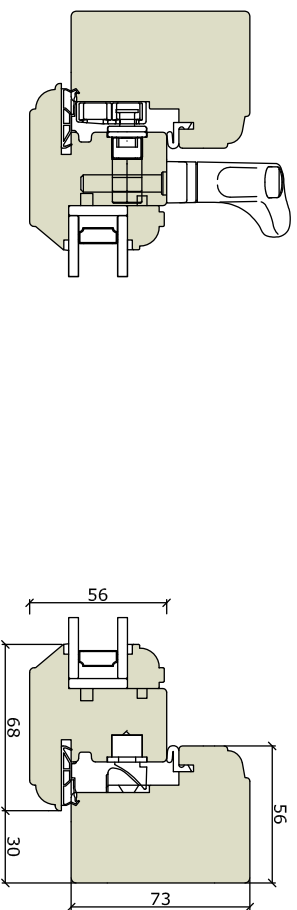

Cill Extension
(Various sizes available)

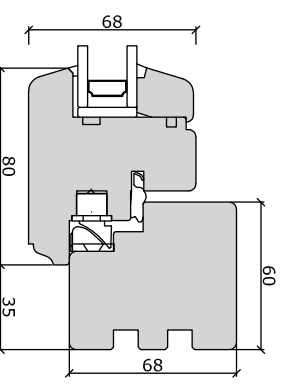

Casement Windows

Casement Flush - Traditional

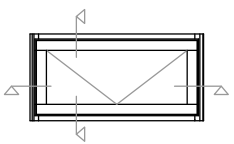

Stepped Trickle Vent
concealed by Head Drip

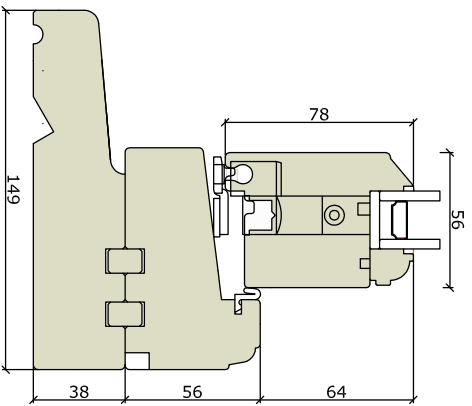
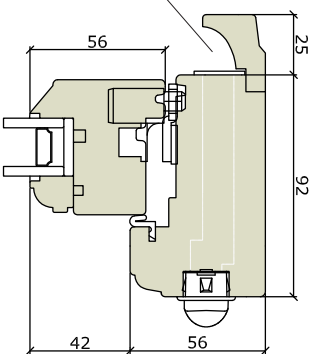

Sub-Cill
(Various sizes available)

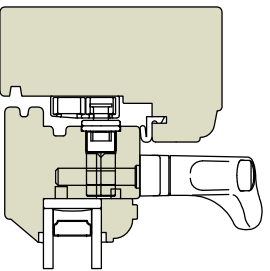

Casement Flush - Heritage

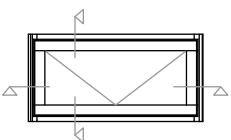

Stepped Trickle Vent
concealed by Head Drip

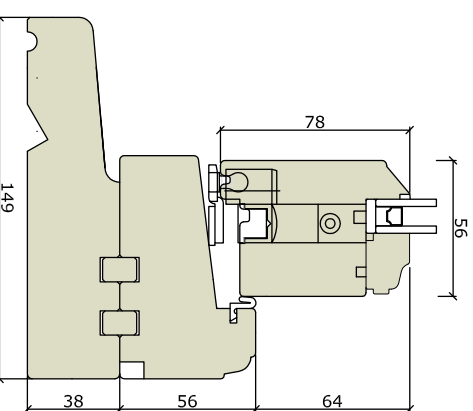
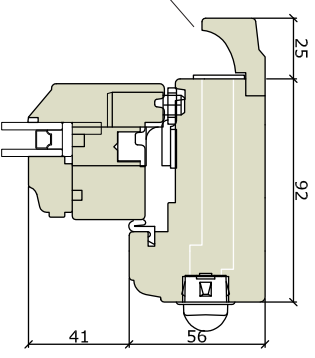

Sub-Cill
(Various sizes available)

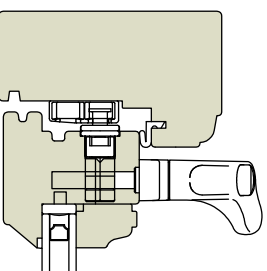

Cill Extension
(Various sizes available)

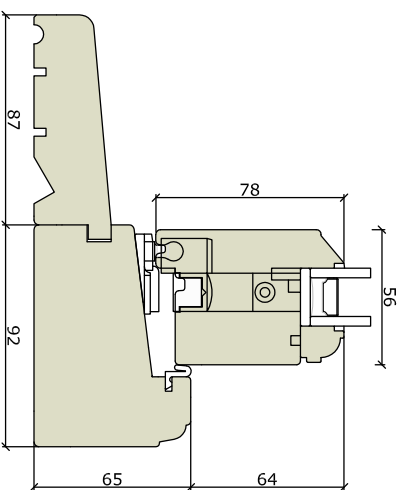
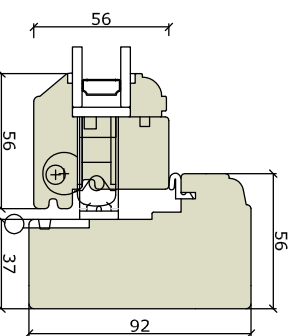

Cill Extension
(Various sizes available)

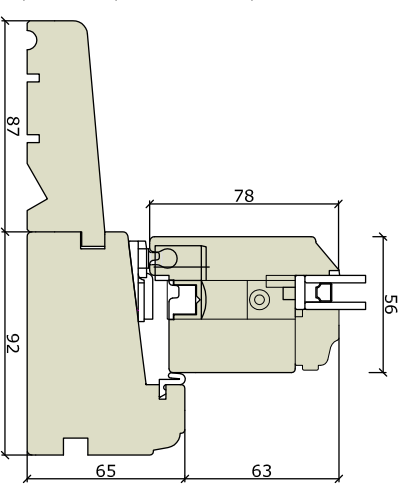
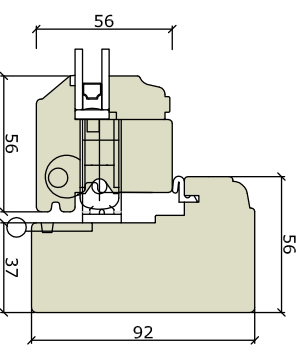

French & Entrance Doors

French/Entrance Door – Flush – Traditional

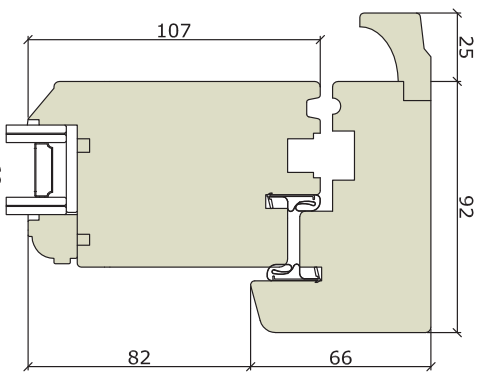

Traditional Range
Outward Opening

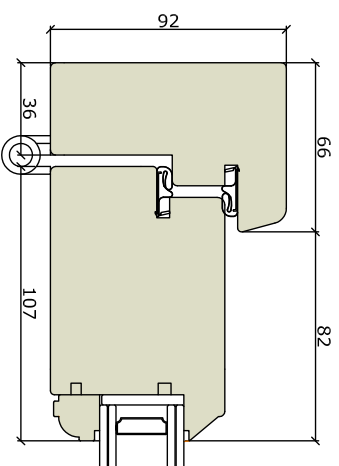

Traditional Range
Inward Opening

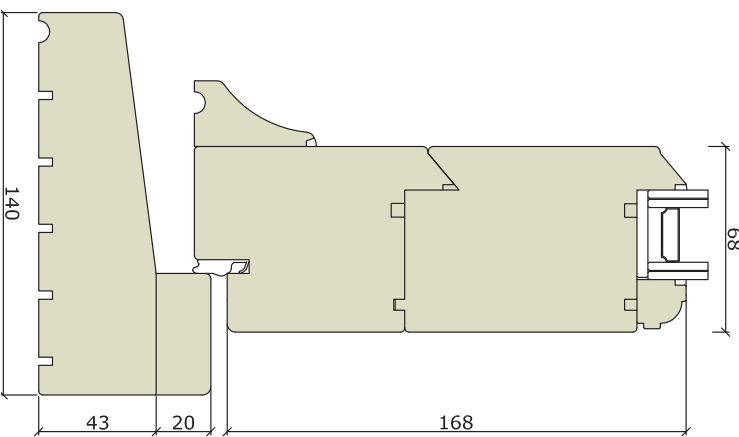
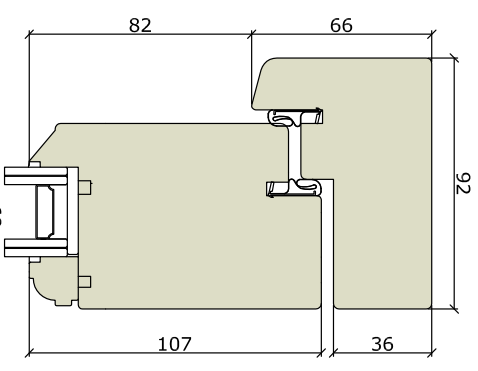
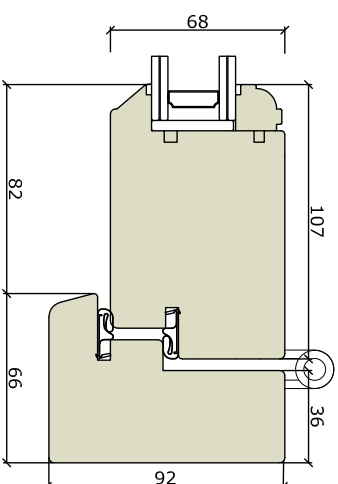

Traditional Range
Outward Opening

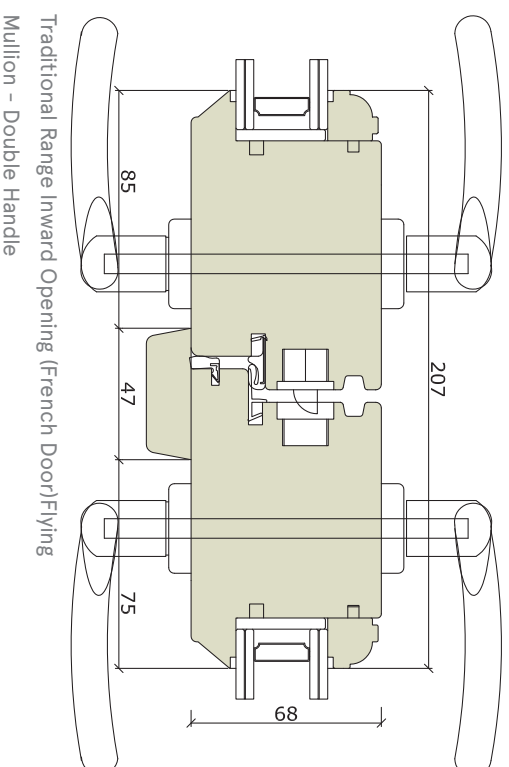

Traditional Range Inward Opening (French Door)/Flying Mullion - Double Handle

Traditional Range
Inward Opening

