



O - Lower Balcony Window



H - Front Bedroom Window

**NOTE**  
All 'Proposed' dimensions are for manufacturing purposes and therefore may differ slightly from the 'Existing' dimensions.

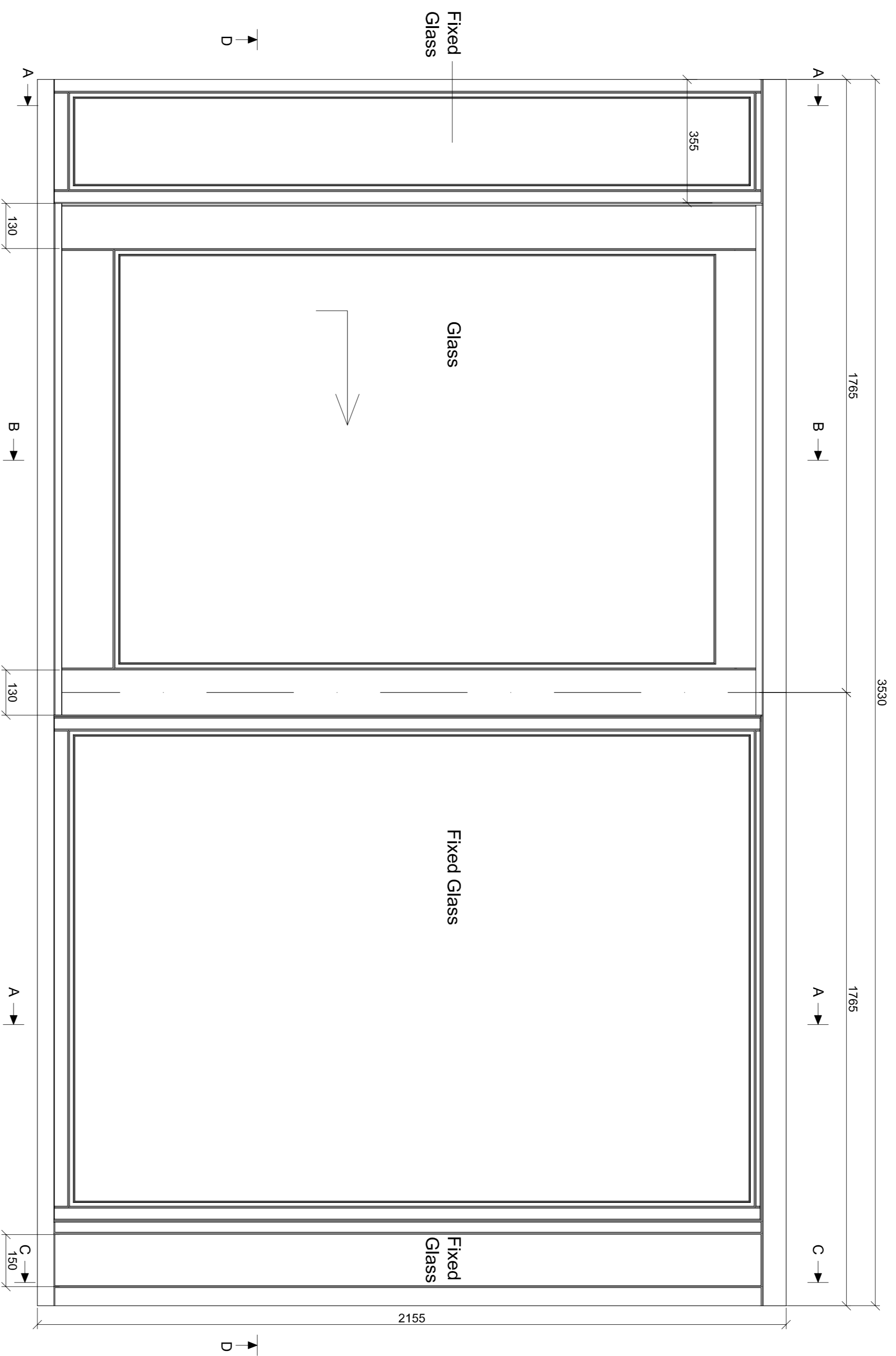
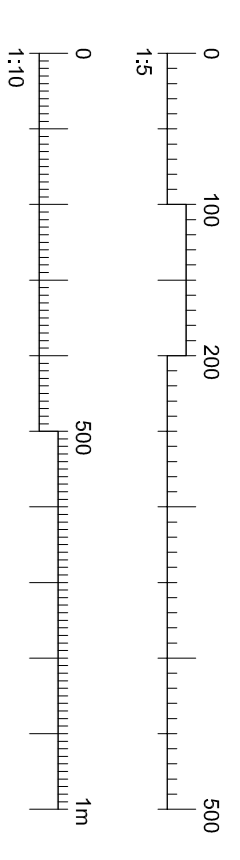

Proposed Type O - Rear  
Lower Balcony Sliding doors.  
scale 1:10

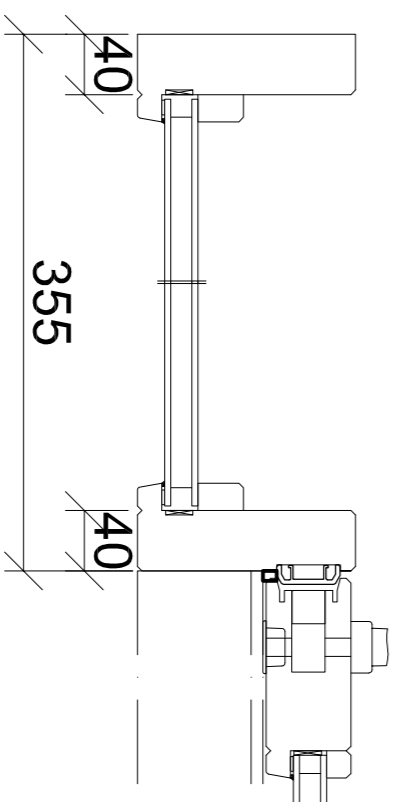

Proposed Jamb Details  
scale 1:5

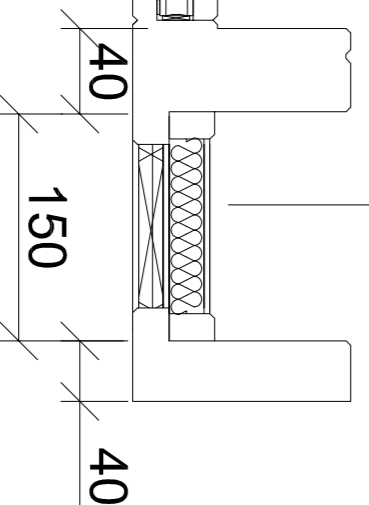
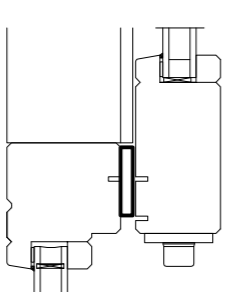

D-D

Insulated panel behind fixed panel

A-A

B-B

C-C

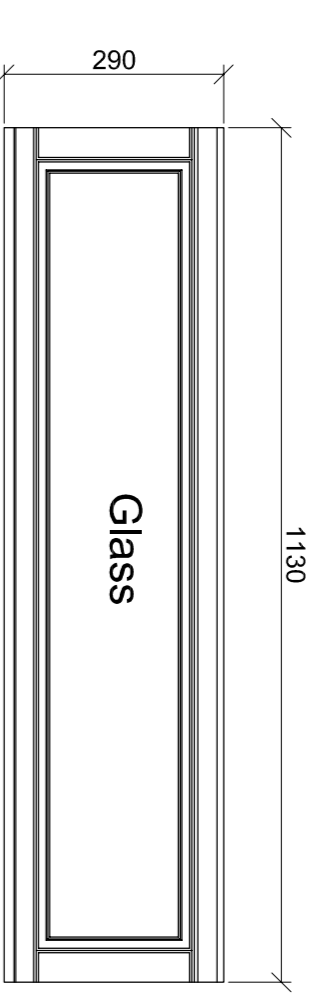

Existing Type H - Front  
Bedroom Window  
scale 1:10

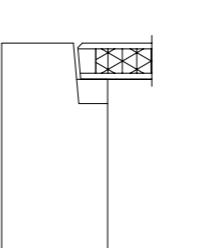
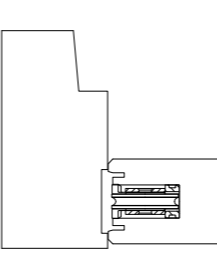
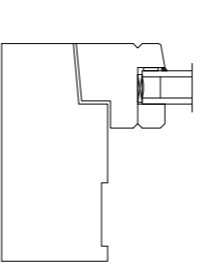
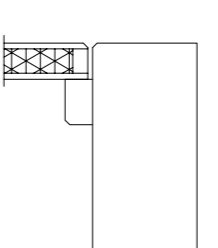
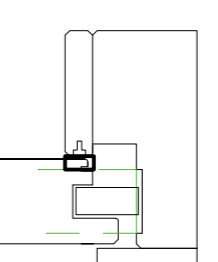
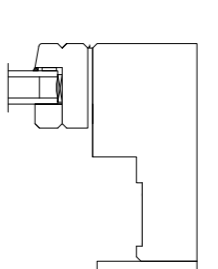

Proposed Head & Cill Details  
scale 1:5

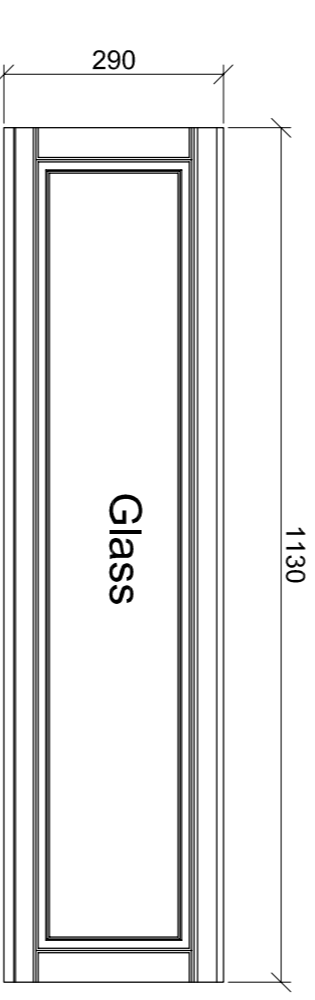

Proposed Type H  
scale 1:10

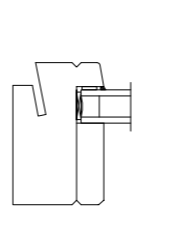
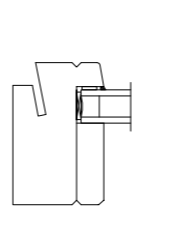

Proposed Head & Cill Details  
scale 1:5

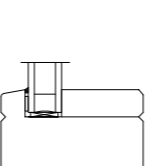
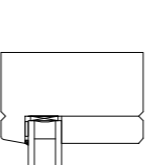

Proposed Head & Cill Details  
scale 1:5

REVISION	DATE
Rev D	11/02/2015
Rev C	10/02/2016
Rev B	15/12/2015
Rev A	08/12/2015

The contractor is responsible to ensure that no products are to be added that do not comply with the relevant Building and/or European Standards and/or Code of Practice. Client Regulations, and/or construction to be determined by the architect and safety to the quality of the work or not in accordance with good building practice.

The contractor is responsible for checking dimensions, materials, work and performance. The drawings are to be checked by the architect and checked before proceeding with the work. Where an item is covered by drawings to different scales, the larger scale drawings to be used.

Do not scale drawings. Figure dimensions to be used in all cases.

This drawing and the copyright and patent therein are the property of Baily Garner LLP and may not be used or reproduced without consent or attribution.

**A1**

CLIENT	PROJECT
Keenpoint Regeneration (Apollo) Ltd	Mansfield Road External Upgrades
ADDRESS	TITLE
Apollo Site Office Kiln Place Lamble Street, NW5 4AB	Proposed Window Type O & Existing & Proposed Types H Planning
SCALE	DATE
1:50	30/11/15
27241	REVISION
	D

