

Camden Planning Guidance

Transport

London Borough of Camden

CPG 7

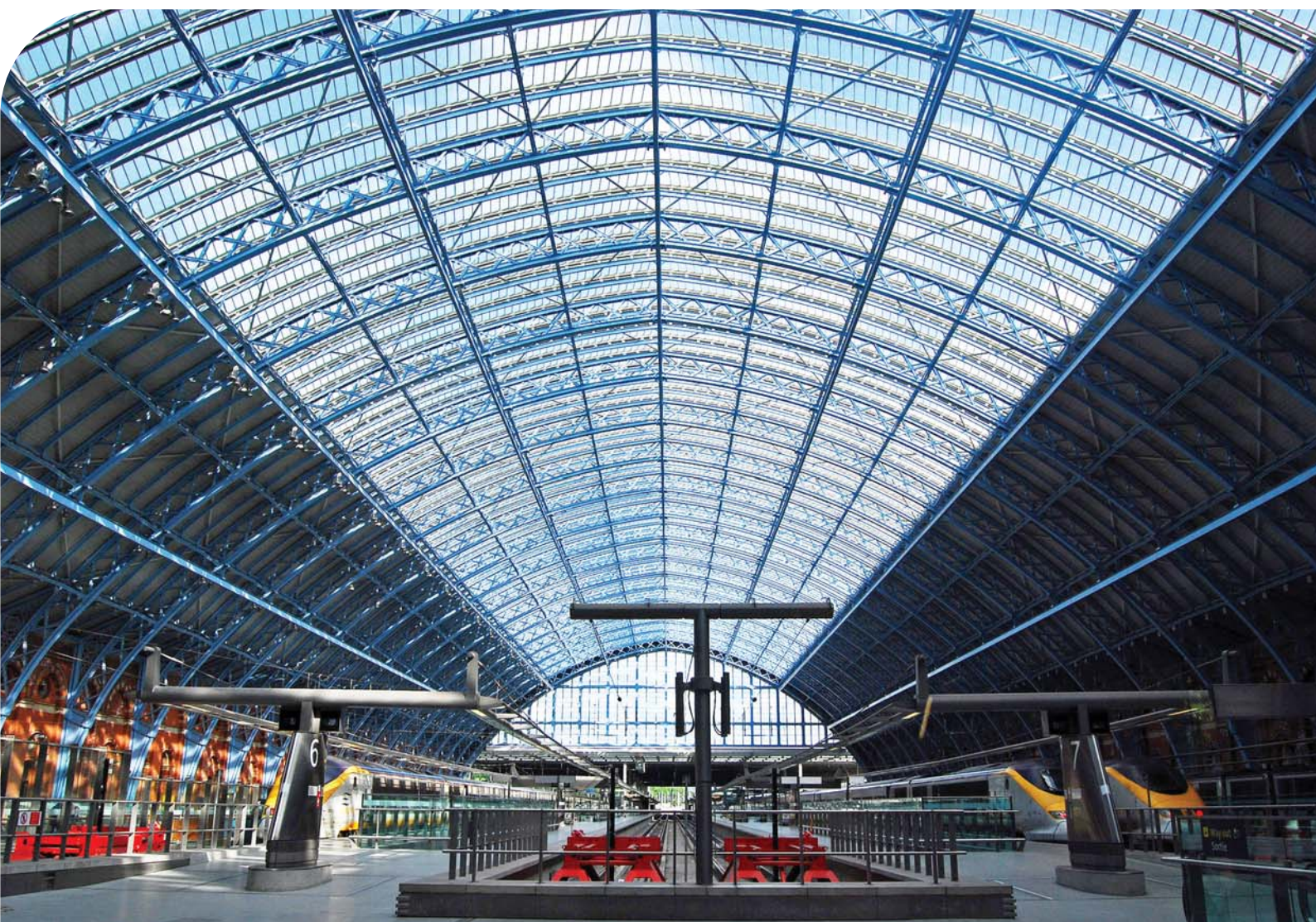

CPG7 Transport

1	Introduction	5
2	Assessing transport capacity	7
3	Travel plans.....	13
4	Delivery and servicing management plans	21
5	Car free and car capped development.....	25
6	On-site car parking.....	29
7	Vehicle access	35
8	Streets and public spaces	41
9	Cycling facilities.....	47
10	Minicab offices	56

Camden Planning Guidance

Transport

London Borough of Camden

CPG 7

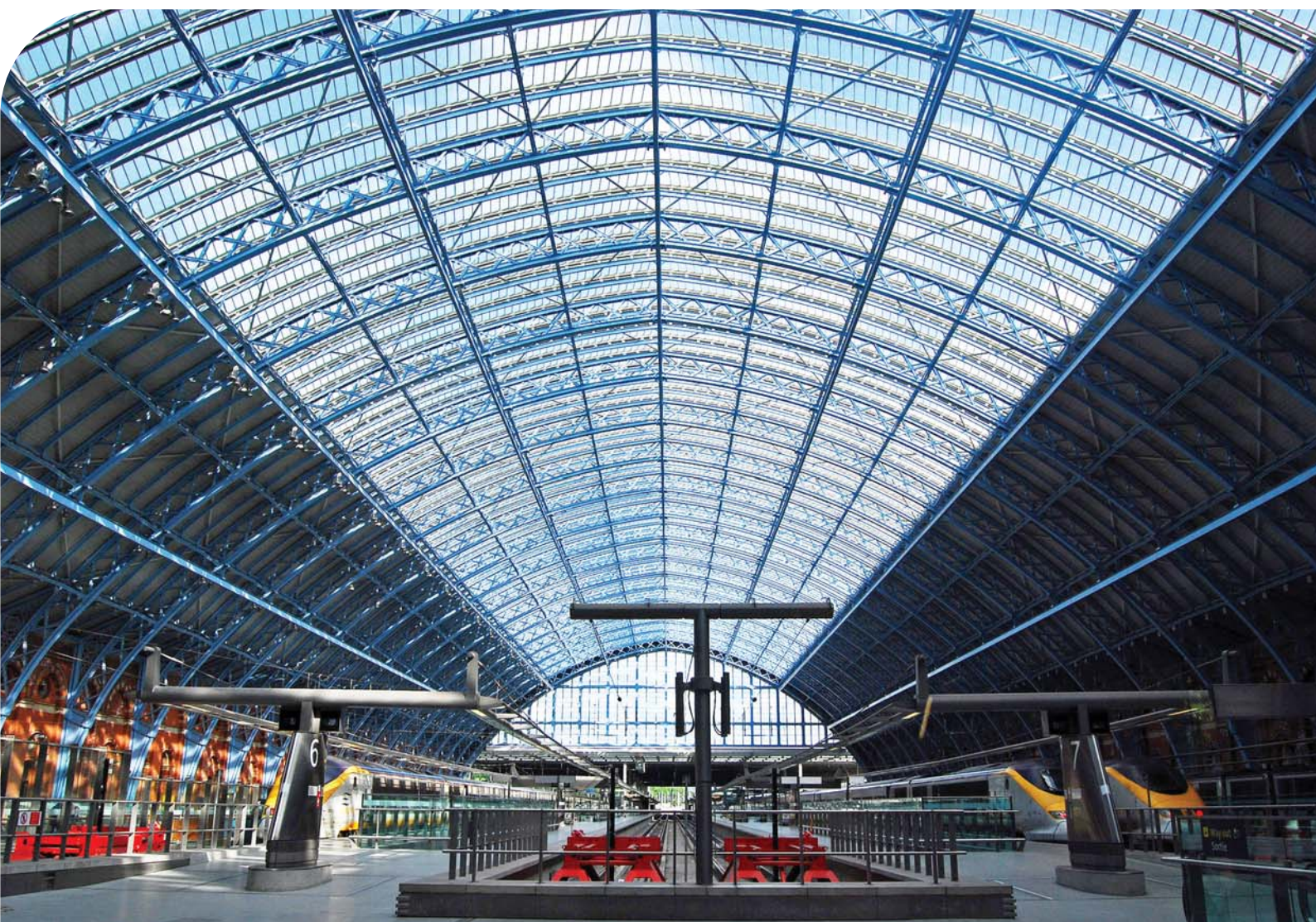

2 Assessing transport capacity

KEY MESSAGES

- A Transport Assessment is required for all schemes which will generate a significant travel demand
- Further guidance is contained within Transport assessment best practice guidance document, TfL 2006

- 2.1 This guidance aims to make sure that applicants submit all the information that is needed to determine a planning application in terms of the assessment of transport conditions before and after the development has taken place, and transport measures that will need to be secured before a development comes into use.
- 2.2 It relates to Camden Core Strategy policy CS11 - *Promoting sustainable and efficient travel* and policy DP16 - *The transport implications of development* of the Camden Development Policies.



When does this apply?

- 2.3 This guidance applies to planning applications that involve a change in the way that a site is accessed from the highway, and planning applications that will alter how people or goods are moved, how many trips they make, and when the trips take place.
- 2.4 Reference should be made to Transport for London's guidance document 'Transport assessment best practice' for more detailed guidance, along with section 2 of this guidance, relating to Travel Plans. In line with policy DP16 of the Camden Development Policies document, where the transport implications of proposals are significant we will

require a Transport Assessment to examine the impact on transport movements arising from the development.

How should Transport Assessments be prepared?

The requirement for a formal Transport Assessment

- 2.5 Appendix 1 of the Camden Development Policies document provides guidance on the scale of development that is likely to generate a significant travel demand and therefore require either a transport assessment or a transport statement. The use class and floorspace relationships in Appendix 1 are simply guidelines, and have been selected on the basis that their travel characteristics are likely to have a significant impact on travel. The Council will require submission of a Transport Assessment for a development likely to have any of the following travel characteristics (having regard to any existing travel generated by activity on the development site):
- a) More than 1,000 person trips per day; or
 - b) More than 100 person trips during the morning or evening peak (0700-1000 or 1600-1900); or
 - c) More than 500 vehicle movements per day; or
 - d) More than 100 vehicle movements in any single hour; or
 - e) More than 20 heavy goods vehicles (over 7½ tonnes) per day; or
 - f) Any heavy goods vehicle movements between midnight and 6am.
- 2.6 Although a formal Transport Assessment is not required for schemes that do not have any of these travel characteristics, where there is any material change to travel patterns, information will still need to be submitted as part of the standard development control process, indicating the amount of travel that will arise, and when and how it will be accommodated (see paragraph 2.12).

Information required as part of a Transport Assessment

- 2.7 At an early stage, applicants should discuss with the Council the scope of the Transport Assessment, and the most appropriate methods to use (e.g. data sources, estimation of trips generation, modelling requirements). The level of information contained within the Transport Assessment should relate in scale and kind to the particular development.
- 2.8 A Transport Assessment should generally include the following information. Please note that this table is a summary of the information contained within Transport assessment best practice guidance document, TfL 2006 and so reference should be to this TfL guidance.

Figure 1. Transport Assessment Requirements

TA1. Description of development	
a) Detailed site plan (min. 1:1250).	Always required.
b) Schedule of floor areas of existing uses on the site.	Always required.
c) Schedule of floor areas of proposed uses on the site.	Always required.
TA2. Description of base networks	
a) Plan showing relationship of site to the surrounding road, public transport, pedestrian and cycle networks. Include any tram routes or proposals.	Study area and base networks to be agreed with the Council.
b) Information on traffic flows, accident records, on-street parking conditions, and identify any critical links and junctions.	For proposals increasing motor vehicle movements, criteria C to D.
c) Information on frequency, reliability and capacity of bus, tram, underground and rail services within the study area.	For proposals increasing trips and trip concentrations, criteria A and B.
TA3. Trip generation	
a) Number of person trips generated by mode and time of day.	Always required.
b) Number and size of vehicles required to service the building.	Always required.
TA4. Trip assignment	
a) Assignment of vehicular trips to the road network.	For proposals increasing motor vehicle movements, criteria C to D
b) Assignment of public transport trips to the bus and rail networks.	For proposals increasing trips and trip concentrations, criteria A and B.
c) Justification for assignment methodology.	Always required.
TA5. Vehicular access and circulation	
a) Analysis of junction design for access and egress, using appropriate packages if necessary (such as PICADY, OSCADY, LINSIG and TRANSYT).	Always required where a new access is provided or where an existing access will be more intensively used.
b) Describe the arrangements for servicing and access for emergency vehicles.	Always required.
c) Describe the number, allocation and design of on-site parking and compare this with Council standards.	Always required.
TA6. Pedestrians and cyclists	
a) Assess the capacity and safety of existing pedestrian and cycle facilities and describe how they are affected by the development.	Always required.
b) Describe the number, allocation and design of on-site cycle parking and compare this with Council standards.	Always required.
c) Describe design features on or outside the site to assist pedestrians and cyclists.	Always required.
TA7. Public transport	
a) Assess the accessibility of the site by public transport.	Always required.
b) Identify BR and Underground stations and lines, tram routes or proposed tram routes, and bus services that will be significantly affected by the development. Evaluate and quantify impact of additional demand on capacity.	For proposals increasing trips and trip concentrations, criteria A and B.
c) Assess and quantify impact of additional road traffic on bus and tram reliability.	For proposals increasing motor vehicle movements, criteria C to D.
TA8. Road network	
a) Identify junctions and links that will be affected by development traffic. Quantify and evaluate the reserve capacity, queues and delays at critical junctions.	For proposals increasing motor vehicle movements, criteria C to D
b) Carry out a Safety Audit.	Only required where physical changes are proposed on the public highway.
TA9. People with a transport disadvantage	
a) Identify measures to make the site accessible to people with a transport disadvantage, including access for community transport services, the provision of designated car parking, drop-off points, shopmobility and scootability schemes (loan of scooters or electric wheelchairs to assist movement in the area around a home or destination from the initial point of arrival), and physical design features.	Always required.
TA10. Environmental impact	
a) The impact of generated traffic on air pollution and noise (unless included in an Environmental Assessment).	For proposals increasing motor vehicle movements, criteria C to D.
TA11. Conclusions and recommendations	
a) Summary of transport impacts.	Always required.
b) Details of remedial measures proposed to alleviate any identified problems or evidence provided that no remedial measures are necessary. In most cases, these will include outline provisions of a Transport Plan.	Always required.

- 2.9 The Regent's Canal in Camden has a transport function for walking and cycling and to a lesser extent for movement of passengers and freight by water. In addition to considering the highway and public transport networks detailed above, where a development is adjacent to the Canal, or the Canal forms a part of the pedestrian and cycle network close to a development, the Transport Assessment should consider how the development may affect travel on and alongside the Canal. Policy DP20 of the Camden Development Policies deals specifically with the use of the Regent's Canal for moving goods and materials.

What should the Transport Assessment achieve?

- 2.10 Where an Assessment is submitted, it should enable the Council to consider whether:
- the development is acceptable in its proposed form and without any alterations to existing transport arrangements;
 - some alteration would be needed to the development or to transport facilities or networks in order to accommodate the travel it would generate in an acceptable way;
 - the development could not proceed without unavoidable harm to travel or the transport system, in which case the proposal will be contrary to LDF policy DP16, and will be refused by the Council if it is not withdrawn.
- 2.11 If the Assessment shows that amendments are needed, it should recommend specific amendments and mechanisms to ensure that these amendments take place in the event of the development being implemented. Recommendations might include:
- conditions to prevent implementation prior to the completion of planned transport provision with secured funding;
 - conditions to ensure that implementation is in phases, such that each phase follows completion of any necessary planned transport provision with secured funding;
 - a legal agreement to ensure submission and implementation of:
 - a travel plan to manage travel demand;
 - a servicing plan to manage on- and off-site servicing arrangements following completion;
 - a construction management plan for the period from commencement to full operational occupation of the development to manage on- and off-site construction traffic, delivery and removal of materials, and any temporary changes to other traffic movements (including pedestrian and cyclist movements) in and around the site;
 - changed on-site arrangements for pedestrians, cyclists, cycles or motor vehicles (including public transport) through substitution of drawings showing amended facilities for movement, picking-up and

setting-down, parking, storage, queuing, loading and unloading, and/or employee lockers and showers;

- changed off-site arrangements for pedestrians, cyclists, cycles or motor vehicles (including public transport) through a legal agreement to ensure funding and implementation of amended or new facilities for movement, picking-up and setting-down, parking, queuing, loading and unloading, and/ or other measures such as public transport services, shelters, information and signage, city car clubs and city car schemes.

Developments below the threshold for Transport Assessment

- 2.12 Development Policy DP16 states that larger developments that would have implications for transport, but which fall below the threshold for a full transport assessment, will still be required to submit information regarding the transport implications of that scheme. Appendix 1 of the Development Policies document provides guideline floorspace thresholds for these types of developments. The type of information required is set out in DP16 and could be submitted as part of a Design and Access Statement.

Further information

Draft Guidance on Transport Assessment, Department for Communities and Local Government/ Department for Transport, August 2006 - this can be viewed on the consultation papers pages in the roads and vehicles section of: www.dft.gov.uk

Transport assessment best practice guidance document, Transport for London, May 2006 – this can be obtained via TfL at: 0845 305 1234

3 Travel plans

KEY MESSAGES

- Travel Plans enable a development to proceed without adverse impact on the transport system
- The requirements of a Travel Plan will be tailored to the specific characteristics of the site and the development

3.1 This guidance explains the circumstances under which travel plans are sought, what they are intended to achieve, how they should be prepared, and what measures should be considered for inclusion. In addition to general guidance for travel plans, this section provides guidance on:

- Workplace travel plans;
- School travel plans;
- Residential travel plans;
- Visitor management plans; and
- Leisure and event travel plans.

3.2 It relates to paragraph 11.16 of Core Strategy policy CS11 - *Promoting sustainable and efficient travel* and policies DP16 to DP21 of the Camden Development Policies.



When does this apply?

3.3 This guidance applies to all planning applications that involve a significant impact on travel or the transport system. It will also guide consideration of Travel Plans submitted where the impacts are less, but where the transport provision does not have capacity for increased demand, and where demand management measures are desirable to

address sustainability concerns. Transport for London recommends that a Travel Plan be submitted for any residential development of over 30 units. Various uses may not fall into these categories (e.g. religious institutions), but we will seek Travel Plans where appropriate and requirements will be tailored to the characteristics of the site and the development.

- 3.4 Reference should be made to Transport for London's documents 'Guidance for workplace travel planning for development' (TfL, 2008) and 'Guidance for residential travel planning in London' (TfL, 2008) for more detailed guidance. Reference should also be made to planning guidance about Transport assessments. In line with Development Policy DP16, the Council will also require a Transport Assessment to be submitted in support of any development that significantly increases travel demand or would have a significant impact on travel or the transport system.

General guidance

- 3.5 Travel Plans are one way in which developments can contribute to meeting targets on traffic reduction and improving air quality. A Travel Plan is a package of measures, generally developed by employers or property managers, which is designed to reduce car use and promote greener forms of transport. Travel Plans will often be a mechanism that arises from a Transport Assessment as a means of enabling a development to proceed without adverse impact on the transport system. The Council, Transport for London, and partners in the North and Central Travel-plan Network can provide advice and assistance in the creation of Travel Plans by organisations that are existing, new, relocating or expanding, including hospitals, schools, and businesses organisations.
- 3.6 Where a Travel Plan is necessary in terms of policy DP16 or because elements of the transport system have no additional capacity, submissions in connection will generally be secured by S106 agreement. This is because the applicant will rarely be the final occupier of the scheme, and furthermore a Travel Plan will require ongoing development subsequent to the initial occupation. Travel Plans will require monitoring on at least an annual basis, and the Council will usually require submission of a monitoring report.
- 3.7 Travel Plans are developed over time, with a typical 3-year target being a specified reduction in the number of motor vehicle trips. This means promoting and increasing cycling, walking, and the use of public transport so that a real choice may be made between all travel methods. It is the enthusiasm and commitment of the organisation in putting the theories into action that ensures a Plan's success. Key to this is the support of senior management in the development of a Travel Plan. If the development does not replace an existing use, the Council will advise on the appropriate modal split targets.

Workplace travel plans

- 3.8 A workplace travel plan will usually contain measures geared particularly to promoting alternatives to single-occupancy car use. A workplace travel plan will be specific to each individual site and the nature of the business activity there. Workplace travel plans are potentially suitable for any organisation that generates a significant number of employee trips including offices, hospitals, distribution centres, large shops and supermarkets, cinemas and theatres, primary care centres and GP surgeries. Specific guidance is available on school travel plans where the travel of pupils needs to be considered.
- 3.9 As a minimum, a workplace travel plan should address travel by staff to and from work and on business. However, a travel plan may also address visitor, client and customer travel, suppliers making deliveries, contractors undertaking work on site and fleet procurement/management.
- 3.10 The key components necessary for all workplace travel plans are:
- corporate/management support and commitment;
 - designated travel co-ordinator;
 - consultation on the plan;
 - staff travel surveys - baseline & monitoring;
 - targets – challenging but achievable;
 - promotion of the package to the workforce;
 - monitoring – on-going, to check and maintain progress and development.
- 3.11 Detailed measures will include some or all of the following:
- restricted availability of workplace car parking, and introduction of charges;
 - a communication strategy detailing how sustainable transport and travel plan issues will be promoted to staff and visitors;
 - easily available in-house public transport information for all staff at the workplace and for visitors, including leaflets and maps, intranet and internet;
 - public transport promotion and initiatives including interest-free season ticket/ travelcard loans, and mutual beneficial links with public transport operators to increase ridership and improve the services convenient for the workplace;
 - promotion of car-sharing where walking, cycling and public transport is not an option;
 - cycle prioritisation and provision of secure and convenient facilities such as: well-lit, workplace parking; lockers; showers and changing rooms;
 - procurement of a cycle repair and servicing facility (possibly through external tender process);

- financial benefits for cyclists such as mileage allowances for work-related journeys, 0% loans and salary sacrifice initiatives for purchase of bikes and equipment, assistance with cycle insurance;
- replacement of company cars with more sustainable benefits, adjusted car allowances and loans to discourage car use and release resources for greener options;
- on-site charging for electric bikes and vehicles;
- reduction of vehicle emissions through policies such as regular emissions testing;
- scheduled replacement of any existing fleet or pool vehicles with pool bikes and other pool vehicles that use cleaner fuels;
- travel reduction initiatives – for example, increased working from home, teleworking and teleconferencing can reduce the number of employee trips to the workplace;
- walking encouragement and provision of information on the best routes to and from the workplace for commuting, working and leisure, for staff and for visitors.

School travel plans

3.12 A school travel plan (STP) can bring benefits of safer and more sustainable transport for the whole community. Each STP will need must be designed to take into account and be tailored to local circumstances. Where a school has strong links with other schools in the area, consideration should be given to developing a joint STP. An STP can potentially result in:

- Less cars and congestion around the school;
- Healthier, more active pupils, families;
- Less pollution around the school;
- Safer walking and cycling routes around the school;
- Improved school grounds with provision for bicycle storage;
- A more accessible school site; and
- Improved attendance and achievement.

3.13 All STPs have to be sent to Camden and to Transport for London for approval. It is essential that an STP complies with the Transport for London criteria used to assess STPs. It must also be signed and approved the school's Headteacher and the Chair before submission. These criteria for assessing STPs are detailed in the TfL publication 'What a school travel plan should contain'.

Residential travel plans

3.14 A residential travel plans provide a key mechanism for ensuring that sustainable access is an integral feature of a development. Each one should form a holistic package of measures integrated into the design, marketing and occupation of the site rather than 'retrofitted' once the

development is established. A residential travel plan provides a mechanism for setting out how the various parties (including the developer and future occupiers) can work together in partnership to encourage sustainable travel patterns.

- 3.15 Residential travel plans are concerned with journeys made from a single origin (home) to multiple and changing destinations. Each residential travel plan is site specific, with detailed measures partly determined by site opportunities and constraints such as the location of existing public transport routes, health facilities and workplaces in the immediate area. A residential travel plan should include parking restraint, and should support walking, cycling and public transport use. A residential travel plan should include both hard measures, such as site-design, provision of infrastructure and new services, and soft measures such as marketing, promotion and awareness-raising among residents. A S106 agreement securing a residential travel plan will also need to require that all future residents are informed of the existence of the travel plan and any restrictions it implies (for example, lack of access to parking permits in controlled zones).
- 3.16 The main objectives of a residential travel plan are to:
- address residents' need for access to a full range of facilities for work, education, health, leisure, recreation and shopping. In some cases this will mean providing facilities that reduce the need to travel, such as a local shop;
 - reduce the traffic generated by the development to a significantly lower level of car trips than would be predicted for the site without the implementation of the travel plan;
 - promote healthy lifestyles and sustainable, vibrant local communities;
 - encourage good urban design principles that open up the permeability of the development for walking and cycling linked to the design and access statements;
 - address specific problems identified in the site's Transport Assessment - for example, a road safety problem that prevents children or older people from gaining access to key facilities.
- 3.17 There are two distinct phases in development of a residential development plan:
- 3.18 Stage 1 should cover design, construction, occupation, and the first monitoring and review period. Preparation and implementation will initially rest with the developer or a consultant appointed by the developer, however implementation may involve a steering group which has representation from different agencies such as the local authority, public transport operators and residents (once they are in occupation). At this stage, the developer, the manager of the development, and the person designated as travel plan coordinator will have to be closely involved in managing and refining the travel plan. This period is crucial in terms of ensuring that the measures outlined in the plan are actively

implemented as part of the development and that the objectives and targets identified in the plan have potential to be met.

- 3.19 Stage 2 will be after full occupation of the development and completion of all measures to integrate the development with the surrounding area. Responsibility for managing and developing the travel plan will generally need to be passed on, and measures put in place to ensure that implementation of the plan continues.
- 3.20 It is important that an effective management structure is put in place to enable the overarching responsibility for the plan to be passed from the developer to the residents or to a residents' management company or to another body such as the Council. The manager will need to be able to ensure the continuation of travel plan measures such as car clubs, car share schemes. A residential travel plan will therefore need to specify its own management structures, which should generally have the following characteristics:
- identifying the developer as the party responsible for delivering the travel plan and for initial implementation, including responsibility for achieving the targets and objectives established in the travel plan. The plan should specify clearly at what point the developer can pass on responsibility for the plan wholly to residents, a management committee, or similar. Up to that time, steering groups and other management structures may assist in implementing the travel plan, provided that the developer retains ultimate responsibility;
 - establishing the ongoing management committee or group with a clear purpose, accountability and ability to take action – this is most likely to be achieved by developing a constitution for the group;
 - providing funding to ensure ongoing administrative support for the group once established and adequate resources to carry out continuing travel plan measures

Visitor management plan

- 3.21 Where developments are likely to involve visitors arriving and leaving in taxis and coaches, submitted proposals should show how these can be accommodated without harm, and a Visitor Management Plan may be required to where it is necessary to impose controls on the types of vehicle, the times of arrival, and the specified picking-up and setting-down points.

Leisure and event travel plan

- 3.22 Event travel plans are designed for short-term events (either regular or one-off) and as such will be implemented differently to workplace travel plans. The general structure of the plan will be similar but the content of each section will be different when dealing with events.

3.23 An event travel plan should contain the following:

- Background information - providing an overview of the event and its organisers and including information on any existing environmental policy, why a travel plan is being produced and detailing the location of the event along with some information on the site's accessibility.
- Site audit and survey - providing the information to inform the rest of the travel plan. The site audit provides details on how accessible the site is by various forms of transport and includes both on-site and off-site infrastructure.
- Aims and objectives - broad statements of intent regarding what it is hoped the travel plan will achieve.
- Targets - There are two types of target that can be set for a travel plan. The first is known as an 'aim-type' target and is generally based on the percentage share of each travel mode used, and the other type of target that is set is the 'action-type' target which sets a deadline for a certain action to have taken place.
- Measures - detailing the various incentives and initiatives that can be employed to achieve the targets set in the previous section. The measures that are implemented will depend on various factors including the results of the surveys, the size of the event (area or number of visitors), the site audit and the amount of funding available.
- Monitoring Strategy and Management Structure – in order to record the overall success of the travel plan as well as how effective individual measures have been.
- Action Plan – providing a summary of how the travel plan will be implemented and monitored. An action plan typically lists the measures that are due to be implemented along with details on who is responsible, when they are to be undertaken, how the success will be gauged and which aims and objectives they relate to.

Further information

Government resources related to travel plans can be viewed in the sustainable travel section of: www.dft.gov.uk

Residential and employment travel plans best practice guidance documents, Transport for London, forthcoming 2006-07 – when published these will be available from TfL at: 0845 305 1234

What a school travel plan should contain, Transport for London - this can be viewed on the Camden Schools/ School Travel Plans/ Success Factors pages in the education section of Camden's website - www.camden.gov.uk/ccm/navigation/education/camden-schools/school-travel-plans/success-factors/

4 Delivery and servicing management plans

KEY MESSAGES

- Transport Assessments represent the best tool to consider how a development can most appropriately be serviced
- Developments should accord with the Servicing Guidelines provided in this guidance

- 4.1 The purpose of this guidance is to give details on how Delivery and Servicing Management Plans can be used to manage and mitigate the potential impacts of deliveries and servicing on the amenity of occupiers and neighbours.
- 4.2 This guidance relates to Core Strategy Policy CS5 - *Managing the impact of growth and development* and policies DP20 - *Movement of goods and materials*, and DP26 - *Managing the impact of development on occupiers and neighbours* of the Camden Development Policies

When does this guidance apply?

- 4.3 This guidance applies to all development proposals which are likely to generate delivery and servicing movement and therefore may incur significant noise and disturbance impacts. Further details on the circumstances in which the Council will expect/require Delivery and Servicing Management Plans are set out within this guidance.

How should Delivery and Servicing Management Plans be prepared?

Service vehicles and waste collection

- 4.4 General guidance on requirements for service vehicles and goods vehicles is given in Development Policy DP20 - *Movement of goods and materials*. Transport Assessments represent the best tool to consider how a development can most appropriately be serviced. Loading and unloading for some developments can safely and appropriately take place on-street, depending on the nature of the street and the development. Where a development is most appropriately serviced off-street, the application should show that the development will accord with the servicing guidelines shown in the table at the end of this section.
- 4.5 Guideline thresholds for the scale of development where a Transport Assessment will be required are given in LDF Development Policies Appendix 1. For development of significant floorspace in commercial use and residential institutions, the LDF proposes off-site bays for servicing, but also proposes a Transport Assessment that can test the appropriateness of alternative solutions.

- 4.6 For retail-type floorspace (Use Classes A1-A5), the guideline threshold is developments of 1,000 sq m or more. For other commercial floorspace, hotels, and institutional residential accommodation such as hotels, colleges and hostels, the guideline threshold is developments of 2,500 sq m or more. The transport characteristics of Use Classes D1-D2 (including surgeries, places of worship and cinemas) are too variable for any assumption to be made about the need for on-site servicing, but a Transport Assessment is sought in most cases.
- 4.7 The scale of a development is not the only factor controlling the servicing needs it generates. A Transport Assessment is required for any development that would significantly impact the transport system under policy DP16 of the Camden Development Policies. This could be expected to include, for example, any development serviced on-street and likely to receive more than 10 deliveries a day or 2 deliveries an hour. Assessment is also required for developments that generate a number of heavy vehicle movements (see the Assessing Transport Capacity section of this guidance).
- 4.8 If waste collection vehicles need to access a development site, this can be a key consideration in the design of motor vehicle access and circulation spaces. Information on the amount of space needed for sorting and storage of waste on-site prior to collection is given in the Waste recycling and storage section of CPG1 Design. The Council does not generally allow waste to be left on the highway for collection on a specified day except in the case of residential development of 6 dwellings or less.
- 4.9 External storage space for large waste containers is sought for residential development of 7 dwellings or more, and for most non-residential development. The external storage space should be at or near street level, and within 10 metres of a place suitable for a collection vehicle to stop. If appropriate external storage space for waste cannot be provided within 10 metres of the public highway, it will generally be necessary for the collection vehicle to access the development site. In this case, circulation spaces will need to be considered in the same way as those for service vehicles.

Servicing Guidelines

Swept paths	Applicants should provide evidence of swept paths on submitted drawings.
Turning areas	Normally, all vehicles must be able to enter and leave the site in a forward facing direction. If in exceptional cases this is not possible, the service area must be designed to enable vehicles to reverse off the highway rather than onto it.
Demarcation	Servicing bays and turning areas should be clearly marked out, for example, by the use of different colours and materials, to discourage their misuse for car parking and storage.
Pedestrians	Care must be taken to provide safe segregated routes for use by pedestrians. Where access roads for service vehicles represent the most direct or visible route for pedestrians, a segregated footway at least 1.8 m in width should be provided with direct links to each pedestrian entrance of each building on site.
Access roads	A minimum carriageway-width of 6.0 m is required where an internal access is designed for two-way use by service vehicles. Where a footway is not provided to each side, a safety margin with a minimum width of 0.5m must be provided wherever there is no footway.
Headroom	A vertical clearance of 3.5m must be provided for light and medium goods vehicles.

Further information

CPG1 Design, LB Camden 2011

Camden Streetscape Design Manual, LB Camden 2005

Camden Council transport strategies and plans, including the Streetscape Design Manual, can be viewed in the transport and streets section of the Council's website

Residential roads and footpaths: layout considerations - Design bulletin 32 (2nd edition), HMSO 1992 – this can be obtained via:

www.tsoshop.co.uk/bookstore.asp

5 Car free and car capped development

KEY MESSAGES

- We expect car free development in the borough's most accessible locations and where a development could lead to on-street parking problems
- Legal agreements will be used to maintain car-free and car-capped development over the lifetime of a scheme

- 5.1 This section explains further the terms car-free and car-capped development, as referred to in the Camden Core Strategy and Camden Development Policies, the mechanisms that are needed to secure them, and the circumstances in which it will be appropriate for the Council to refuse additional dwellings that are not car free or car capped.
- 5.2 It relates to Core Strategy Policy CS7 – *Promoting sustainable and efficient travel* and policies DP18 – *Parking standards and limiting the availability of parking* and DP19 - *Managing the impact of parking* of the Camden Development Policies.

Car-free development

A development which has no parking within the site and occupiers are not issued with on-street parking permits

Car-capped development

A development which has a limited amount of on-site car parking, but no access to on-street parking permits.

- 5.3 Car-free and car capped development is successful in Camden because most of the borough has very good access to public transport services. Levels of car ownership are low compared with London generally, and choosing not to own a car can be an attractive lifestyle option. The guidance in this section covers:
- What car free development is, and where it is sought;
 - What car capped development is, and where it is sought;
 - Implementation of off-street parking restrictions for car-free and car-capped development, including partial provision of car free and car capped development, and maintaining the on-street parking rights of existing occupiers;
 - Meeting the parking needs of disabled people.

When we expect car free and car capped housing

- 5.4 Car free and car capped requirements apply to developments in particular locations and circumstances:
- we expect car free development in the Central London area, our town centres and other areas with high public transport accessibility (see Development Policy DP18);

- we will also expect car free development where the creation of a new access could lead to on-street parking problems where the loss of kerb space creates unacceptable parking pressure. Refer to Development Policy DP21, and the Access section of this guidance for more information);
 - Car capped development applies to schemes that would have an unacceptable impact on on-street parking conditions or highway management and safety through the introduction of new units with access to on-street parking permits (see Development Policy DP19).
- 5.5 Car-free or car-capped housing may be sought wherever development involves the creation of one or more additional dwellings – whether newly built, or created by a conversion or change-of-use.
- 5.6 Non-residential development can potentially involve car-free or car-capped designation if it creates a new non-residential address or involves a change-of-use that would otherwise increase the demand for car parking. This reflects the operation of the parking permit scheme, where permits relate to individual addresses.

Car free development

- 5.7 Car-free development is development that does not have any car parking. No parking is provided or allowed on the site (except parking designated for disabled people), and all of the dwellings or units created are not entitled to on-street car parking permits. Where we seek car free development our parking standards do not apply as no parking is allowed.
- 5.8 Camden Development Policy DP18 states that we will expect development to be car free in the Central London Area, the town centres of Camden Town, Finchley Road/ Swiss Cottage, Kentish Town, Kilburn High Road and West Hampstead, and other highly accessible areas.
- 5.9 'Highly accessible areas' are considered to be areas with a public transport accessibility level (PTAL) of 4 and above. The PTAL of a specific site can be established using Transport for London's Planning Information Database website pages, which can be found at: <http://webpid.elgin.gov.uk/>.
- 5.10 Car free development will also be required where the creation of an access to allow off-street parking would reduce the availability of on-street parking (see also section 6 of this guidance on vehicle access), or would otherwise cause problems relating to highway management or safety. Policy DP19 of the Camden Development Policies states that we will resist developments that would harm on-street parking conditions or harm highway safety.

Car capped development

- 5.11 Car-capped development is development in which all of the dwellings or units created are not entitled to on-street car parking permits, although some or all of the dwellings or units created may have a parking space

on the site, in accordance Camden's parking standards (see policy DP18 and Appendix 2 of the Camden Development Policies). It therefore differs from car free development because some on-site car parking is allowed, in line with Camden's parking standards.

- 5.12 Car capped development is sought in developments that are not in the locations listed in paragraph 4.7 above, where additional off-street spaces can be accommodated within the development without harming highway or on-street parking conditions, but where additional on-street car parking is not considered acceptable.

Circumstances where additional on-street car parking is not acceptable

- 5.13 There are parts of the Borough where increasing competition for on-street parking through introducing additional premises with on-street parking rights is not acceptable. This is generally the case in the Central London Area, but also in many other areas where the parking spaces available cannot meet existing demand. This has implications for queuing and congestion, illegal parking, and highway safety. In these circumstances, if a developer will not enter into an agreement to designate the additional development as car-free or car-capped, planning permission will not be given.
- 5.14 In considering the ability of available on-street parking to accommodate the impact of additional development, we will have regard to the cumulative effect of proposals in the area, including unimplemented and partly implemented schemes already granted planning approval.
- 5.15 Our Parking and Enforcement Plan provides regularly updated permit data, which is used to establish levels of on-street parking pressure on each of the borough's roads. This information will be used when considering the acceptability of applications that would involve the potential allocation of additional on-street parking permits to the future occupiers of new development.

Implementation of on-street parking restrictions for car-free and car-capped development

- 5.16 The whole of Camden has controlled parking and, in principle, is appropriate for car-free or car-capped development. On most days, most parking spaces on residential streets are only available to people holding a parking permit issued by the Council. In Controlled Parking Zones we can restrict access to on-street car parking because we can control the issuing of parking permits.

Controlled Parking Zones

Designated areas in regulations control how parking may be used on different sections of the street and at different times.

- 5.17 In order to be able to maintain car-free and car-capped development over the lifetime of a scheme, the developer will be required to enter into

a legal agreement under Section 106 of the Town and Country Planning Act 1990 (as amended), which would permanently remove the entitlement to an on street parking permit for each home created:

- 5.18 The legal agreement requires the owner of the development to inform incoming occupiers that they are not eligible to obtain a parking permit for on-street parking, or to purchase a space in a Council-controlled car park. This part of the legal agreement stays on the local search in perpetuity so that any future purchaser of the property is informed that occupiers are not eligible for parking permits.

Maintaining on-street parking rights of existing occupiers

- 5.19 Existing parking rights can normally be retained on development sites, where it can be demonstrated that existing occupiers are to return to the address when it is completed. This is common where an existing dwelling or block is being extended or subdivided. It can also occur where a change-of-use brings a site or property into residential occupation.
- 5.20 If a development is to have new occupiers, existing parking rights will not apply, and the Council will apply its car-free / car-capped policies as set out in Development Policies DP18 and DP19.

Meeting the needs of disabled people

- 5.21 Car-free development and car-capped development should be designed taking into account the needs of disabled car users. Blue Badge holders are able to use parking spaces in Controlled Parking Zones without a parking permit. Minimum parking standards apply to parking for people with disabilities, and 1 parking space for people with disabilities is required per 10 general-purpose dwellings (see Appendix 2 of the Camden Development Policies document). In addition, where car-free and car-capped developments contain wheelchair housing, the Council will expect a parking space to be provided for each wheelchair dwelling. Where a resident in need of a reserved disabled parking space moves into a development with no off-street spaces, the Council will consider a request for a designated disabled space on-street in the same way whether the development is formally car-free or not.

Further information

- 5.22 In addition the guidance above regard should also be had to Camden's Parking and Enforcement Plan (2004), which provides further information on our approach to managing parking in the borough.

6 On-site car parking

KEY MESSAGES

This section includes detailed guidance on:

- Implementation of numerical car parking standards
- Dimensions and layout of spaces, including dedicated spaces for disabled people
- Underground and stacked parking
- Car clubs and pool cars
- Electric charging points

6.1 This section assists applicants for developments that will involve the provision of off-street parking spaces.

6.2 It relates to Core Strategy Policy CS11 - *Promoting sustainable and efficient travel* and policy DP18 - *Parking standards and limiting the availability of car parking*; and Appendix 2 Parking standards of the Camden Development Policies. It should be read in conjunction with section 6 of this guidance on vehicle access.

When does this apply?

6.3 This guidance applies to planning applications that involve creation of off-street parking spaces, in line with the standards set out in the Camden Development Policies. The parking requirements for emergency services, such as ambulance, fire and policing facilities, will be assessed on an individual basis, having regard to the specific operational needs of a particular use.

6.4 Applicants should first seek to minimise car use from their development, in accordance with Core Strategy Policy CS11 and policies DP16-DP20 of the Camden Development Policies. Alternative measures include:

- provision for walking, cycling and public transport;
- car-free development so that there is no need for parking; and
- car clubs and pool cars.

How should on-site car parking be provided?

6.5 Standards for the number of spaces required for car parking and servicing are given in Camden Development Policies Appendix 2.

6.6 Thresholds and standards are given as a gross floor area (GFA) relating to the development as a whole, and are not intended to be applied separately to individual units that form part of a larger development. Shared use of parking spaces and servicing bays between units will be encouraged where practical.

- 6.7 Where a development crosses a threshold, requirements apply to the entire floorspace, not only the floorspace above the threshold. For example, for hotels, the requirement for visitor parking spaces for people with disabilities is 1 space per 1,250 sq m from a threshold of 2,500 sq m (Development Policies Appendix 2). This means that no requirement applies to a hotel of 2,000 sq m, but for a hotel of 5,000 sq m, a requirement of 4 spaces for disabled visitors applies.
- 6.8 Paragraph 18.7 of Camden Development Policies addresses the provision of parking for employees with a need for “continuous access to a car for work purposes”, as part of the maximum standards for employment generating uses. For the removal of doubt, this refers to travel needs that cannot be met by walking, cycling or public transport, and relates to access during the working day, not commuting to and from work

Dimensions and layout of car parking spaces

- 6.9 Figure 2 below sets out our minimum standards for the dimensions and layout for off-street car parking spaces.

Figure 2. Dimensions and layout of car parking spaces

Off-street car parking space (standard)	2.4m wide by 4.8m deep.
Front Garden/Forecourt	5.0m wide by 6.0m deep.
Off-street car parking space for use by disabled people	3.3m wide by 4.8m deep.
Layout of car parking spaces for general use	<p>90° parking – aisles may be two-way The minimum aisle width between the ends of spaces is 6.0m</p> <p>60° parking – aisles must be one-way The minimum aisle width between the ends of spaces is 4.2m</p> <p>45° parking – aisles must be one-way The minimum aisle width between the ends of spaces is 3.6m</p>

- 6.10 Disabled parking should be in line with the Mayor’s Draft London Housing Design Guide SPG (July 2009), which states in paragraph 3.3.2 that “Each designated wheelchair accessible dwelling should have a car parking space 2.4m wide with a clear access way to one side of 1.2m wide”.
- 6.11 Dedicated car parking spaces for use by disabled people should be designated with appropriate markings and signs. These spaces should be located as close as possible to main pedestrian entrances and passenger lifts. There must be no obstruction – such as a raised kerb or

heavy doors - between the parking spaces and the entrance to the building. In considering the appropriateness of distances to the furthest facility served by a dedicated parking space, the following guidelines will be taken into account:

Uncovered route	Less than 50m
Covered route (unenclosed or part enclosed)	Less than 100m
Completely enclosed route (unaffected by bad weather)	Less than 200m

- 6.12 In addition to dedicated parking spaces, where premises are likely to attract visits by the public, vehicular setting down and picking up points suitable for use by disabled people should be available as close to main building entrances and passenger lifts as possible.

Underground and stacked parking

- 6.13 Because of the high cost of land in Camden, some developers are seeking to use more space-efficient forms of car parking, such as underground and 'stacked' parking.
- 6.14 Whilst the Council considers that such provision can be appropriate in some circumstances, it must not cause harm in terms of visual impact and safety. In particular, proposals for underground and stacked parking would need to satisfactorily address potential issues in relation to vehicles queuing/ waiting, and impact on the highway, congestion and safety as vehicles manoeuvre around the site, along with any archaeological implications.
- 6.15 As with any car parking provision, underground and stacked parking must meet Camden's parking standards.

Car clubs

- 6.16 Paragraphs 11.18 of the Camden Core Strategy and 18.14 and 18.15 of the Camden Development Policies encourage the provision of car club spaces as an alternative to the provision of private car spaces, in order to make private transport more sustainable.
- 6.17 We will seek publicly accessible spaces, where provision is made as part of development. This enables spaces to form part of a wider network, improving accessibility to spaces, benefitting the local community and reducing impact on the public highway (by avoiding the provision of additional on-street spaces).
- 6.18 Developers should provide spaces for a Camden-approved city car club operator. Please contact the Council for our full list of approved operators.
- 6.19 The Council's preference is for the provision of car club spaces for electric or low carbon vehicles.



Electric charging points

- 6.20 As part of our approach to making private transport more sustainable, the Council promotes the use of low emission vehicles, including through the provision of electric charging points (see Camden Core Strategy Policy CS11).
- 6.21 Electric charging points allow electric vehicles to charge up whilst parked, ready for the next journey, and are normally located in dedicated parking bays. Further information on electric charging points can be found at: <http://www.newride.org.uk/>
- 6.22 We will seek the provision of electric charging points as part of any car parking provision in new developments (policy DP18 of the Camden Development Policies). The emerging London Plan (policy 6.13 Parking) states that 1 in 5 new spaces provided in new developments should provide charging points.
- 6.23 The Council will promote provision of electric vehicle charging spaces as an alternative to any general car parking spaces, but particularly if the charging spaces will be for electric pool cars or electric car-club cars. We will encourage use of renewable energy to provide power for charging points.
- 6.24 Parking for low emission vehicles, pool cars and car clubs should be provided from within the general car parking allowed by Camden's parking standards. If they are provided in addition to general car parking spaces, they are unlikely to be effective in encouraging more sustainable means of transport, and to the Council's overall aim of reducing congestion in the Borough.

Further information

- 6.25 The creation of off-street parking spaces will often require the creation of a new vehicle access to a site. This section should therefore be read alongside section 6 of this guidance on Access to sites for motor vehicles, which sets out how proposals involving new means access are judged in terms of impact on the highway, safety and visibility for emerging vehicles.

6.26 Other useful sources of information include:

- Mayor’s draft Housing SPG, which contains detailed guidance on the levels of car parking;
- Manual for streets; DfT; 2007, which provides guidance on accommodating car parking within the street environment; and
- Camden Parking and enforcement plan, which sets out a comprehensive approach to managing parking and addresses the need for effective enforcement of parking controls, for both on-street and off-street parking.

7 Vehicle access

KEY MESSAGES

- Planning permission must be sought for works to create or alter an access onto a classified road
- The Council will not approve applications that would cause unacceptable parking pressure or add to existing parking problems

- 7.1 This section gives guidance on designing developments to provide safe access and use by motor vehicles, ensuring that new means of access do not cause harm to the safety of other users of the development and the adjacent highway. It focuses on the Council's approach to planning applications that include new footway crossovers and new access routes to enable access to properties and sites.

Footway crossover

A dropped kerb or short ramp to permit vehicle access.

- 7.2 It relates to Core Strategy Policy CS11 - *Promoting sustainable and efficient travel* and policies DP18 - *Parking standards*; DP19 - *Managing the impact of parking*; and DP21 - *Development connecting to the highway network* within the Development Policies.
- 7.3 This section provides guidance on how proposals are judged in terms of:
- impact on the highway network and on-street parking conditions;
 - visibility and sightlines for emerging vehicles;
 - impact on the footway;
 - layout and dimensions for footway crossovers; and
 - Preventing waiting on the highway for schemes that include controlled access points, lifts and ramps.

When does this apply?

- 7.4 This guidance applies to planning applications that involve a change in the way that a site is accessed from the highway.
- 7.5 Planning permission must be sought for works to create or alter an access onto a classified road, including a crossover over a footway or pavement to provide access onto private land. However, there are certain circumstances where planning permission may not be required for access to a paved area or garage. These can include an access:
- from a road that is not classified (classified roads are listed in the Camden Network Management Plan);
 - to a property that is not subdivided into flats, and is occupied by a single household.

Classified road

A road which has a number in the national road system (i.e. M - motorway, A - first-class road, and B - secondary road).

- 7.6 Before considering applications for vehicle access we will first assess how an application has sought to minimise car use in accordance with Core Strategy Policy CS11 and policies DP16 - DP20 of the Camden Development Policies document. Relevant alternative measures include:
- provision for walking, cycling and public transport;
 - car-free development so that there is no need for parking; and
 - car clubs and pool cars.

- 7.7 It should also be noted that, separately to planning permission, consent is required from the relevant Highway Authority for a new or altered access from the public highway onto private land, and must be obtained before embarking on any work. The Council is the Highway Authority for all public roads in the Borough except the Transport for London Road Network (see Development Policies Map 1), for which, Transport for London is responsible.

How should vehicle access be provided?

- 7.8 Access to a site by motor vehicles will either be by driving over the footway using a crossover or the footway will be interrupted by a new junction to create a level access direct from the carriageway:
- Crossovers may be appropriate where the site is not intensively used by vehicles. The Council's Street Management Division will advise on the appropriateness of crossovers and, where a crossover is appropriate, will generally carry out its construction at the developer's expense, in accordance with the design requirements set out in the Camden Streetscape Design Manual;
 - Direct access using a new junction is likely to be appropriate either where the site is intensively used by vehicles, or where access is required by heavy goods vehicles. The Council will seek adoption of new roads, and so they must be designed in conjunction with the Council's Street Management Division (see Development Policy DP21).

Impact on the highway network and on-street parking conditions

- 7.9 The Council's approach to development and highway management is set out in policy DP21 of the Camden Development Policies, which seeks to ensure that new connections to the highway network from developments do not cause harm to the network, to its users or the environment. Applicants whose schemes will connect directly to the highway network should also refer to Camden's Network Management Plan and consult Council.
- 7.10 The creation of off-street parking and new access routes frequently involves the loss of on-street parking spaces due to the creation of a

crossover over the kerb. As set out in paragraphs 19.6 - 19.9 of the Camden Development Policies document, we will not approve applications for planning permission (and for highways consent) that would cause unacceptable parking pressure or add to existing parking problems.

- 7.11 Camden's Parking Enforcement Plan Parking provides regularly updated parking permit data, which is used to establish levels of on-street parking pressure on each of Camden's roads. This information will be used when considering the acceptability of applications that would involve the loss of on-street parking spaces.
- 7.12 We will require developments to be car free, where necessary, in order to avoid harmful impacts on on-street parking conditions through the creation of new access routes (see section 4 of this guidance for more information on our approach to car free development).

Visibility and sightlines for emerging vehicles

- 7.13 Vehicles joining the highway network need clear views of pedestrians, cyclists and other traffic, and users of the highway network need clear views of those joining it. Views can be obstructed by boundary treatments and parked cars. The relationship between motor vehicles and cyclists and pedestrians is particularly sensitive.
- 7.14 Adequate visibility for emerging vehicles should be provided with new vehicle accesses, or development that effects existing vehicular accesses. Developers should refer to the Manual for Streets for guidance.

Layout and dimensions for footway crossovers

- 7.15 It is essential that footway crossovers do not harm ease of pedestrian movement, and the front building line should provide a minimum pavement width of at least 1.8 metres. Any changes to the public highway would need to be approved by the highway authority and design details should be discussed with Camden highway authority prior to the submission of an application.
- 7.16 It is important that new access points are not overly steep, in order to allow for safe and convenient access. For normal pavement crossovers that involve a dropped kerb, the Council will apply the following gradients:
- Vehicular ramps from the carriageway to the area of level footway should be a maximum of 15% (1:6);
 - For pedestrians dropped kerbs should be a lower gradient.
 - For longer vehicular ramps, the Council will apply the following gradients:
 - Vehicular ramps should be a maximum gradient of 10% (1:10)

- For pedestrians, ramps should be a maximum gradient of 1:12, in line with the Disability Discrimination Act (DDA) requirements (although a gradient of 1:20 is preferred)

7.17 Where possible, the ground floor level of a development should be the same as the level of the highway, in order to avoid the provision of unnecessary steps, and to allow the footway to be constructed with an adequate slope (i.e. “crossfall”) to allow water run off.

Preventing waiting on the highway: Controlled access points, lifts and ramps

7.18 Sometimes it will be necessary to provide a limited amount of space for vehicles on the site or curtilage, with controls at the point of entry and/ or provision of vehicle space at a different level from the street, accessed by a vehicle ramp or lift.

<p>Curtilage The enclosed area of land adjacent to a dwelling house.</p>

7.19 In each case, an area should be provided within the site for all vehicles waiting for a traffic signal, barrier or vehicle lift. This area should be sufficient to accommodate the maximum likely number of queuing vehicles, without any obstruction to pedestrians and vehicles using the public highway. Where a lift, ramp or other access is only available to one vehicle or direction of flow, there must be space at each end for leaving vehicles to pass those queuing to enter.

7.20 Depending on expected traffic flows, access roads may be expected to be two-way. Segregated areas for pedestrians and/ or cyclists may also be required.

Further information

7.21 The Council’s Road Network Management Plan establishes the road hierarchy in Camden and provides a list of classified roads in the borough. It sets out how the Council will manage the road network in order to provide for efficient movement of vehicles and pedestrians and reduce disruption and congestion.

7.22 The Camden Streetscape Design Manual provides information on the Council’s expectations for the detailed design and layout of highways, footways and public spaces in Camden. Detailed consideration should be given to the Manual before designing any highway works.

7.23 Other relevant documents include:

- Department of Environment, Department of Transport Design Bulletin 32 - Residential Roads and Footpaths - Layout Considerations – which describes the main considerations that should be taken into account in the design of residential layouts. It also takes into account new initiatives on matters such as road safety and includes references to improvement schemes on existing estates.

- Design Manual for Streets; DfT, 2007 – which provides advice for the design of residential streets and the creation of sustainable and inclusive public spaces.
- Design manual for roads and bridges – which is a series of 15 volumes that provide official standards, advice notes and other documents relating to the design, assessment and operation of trunk roads and motorways.

7.24 Regard should also be had to:

- the creation of high quality streets and public spaces (see section 7 of this guidance);
- potential community safety issues associated with forecourt parking – see Core Strategy policy CS17 and Designing safer environments section of the CPG1 Design.

8 Streets and public spaces

KEY MESSAGES

- New development should contribute to the creation of attractive, clean and well-maintained public places
- All new pedestrian areas and footpaths are required to be constructed to a standard that is considered appropriate for adoption by the relevant Highway Authority.

- 8.1 This section provides guidance on the design and layout of streets and public spaces. It aims to ensure that a good quality pedestrian environment and good pedestrian access are provided. This includes ensuring that development is accessible to all members of the community, including all disability groups.
- 8.2 The guidance relates to Camden Core Strategy Policy CS11 - *Promoting sustainable and efficient travel* and policies DP16 - *The transport implications of development* and DP17 - *Walking, cycling and public transport* and DP21 - *Development connecting to the highway network* in Camden Development Policies.

Public realm

All areas to which the public has open access.

Legible London scheme

A new signage scheme which aims simplify pedestrian movement around London.



- 8.3 This section includes guidance for the design and layout of streets and public spaces including:
- quality of the public realm;
 - ease of pedestrian movement;
 - street furniture;
 - footpaths that are not alongside roads,
 - our approach to shared surfaces; and
 - information on the Legible London scheme.

When does this apply?

- 8.4 This guidance applies to planning applications that involve a change in the way that pedestrians access a site or move in and around the site, and also applications that change vehicle movements in a way that will affect pedestrians.
- 8.5 It should guide arrangements for pedestrians that arrive by car, public transport or bicycle, as well as those arriving on foot.

The design and layout of streets and public spaces

CAMDEN STREETSCAPE DESIGN MANUAL (2005)

Provides useful guidance for those who are planning the design and layout of streets and public spaces. The manual sets out the Council's detailed expectations for street works in the borough, addressing issues such as responding to local character, footway design and materials, and street furniture.

General principles

- 8.6 We will seek improvements to streets and spaces to ensure good quality access and circulation arrangements for all. This includes improvement to existing routes and footways that will serve the development. Key considerations informing the design streets and public spaces include the following:
- Camden Streetscape Design Manual;
 - ensuring the safety of vulnerable road users, including children, elderly people and people with mobility difficulties, sight impairments, and other disabilities;
 - maximising pedestrian accessibility and minimising journey times;
 - providing stretches of continuous public footways without public highway crossings;
 - linking to, maintaining, extending and improving the network of pedestrian pathways;
 - maximising pedestrian safety by providing adequate lighting and overlooking from adjacent buildings;
 - taking account of surrounding context and character of area

- providing a high quality environment in terms of appearance, design and construction, paying attention to Conservation Areas, and using traditional materials (such as natural stone or granite setts) where appropriate,
- use of paving surfaces which enhance ease of movement for vulnerable road users; and
- avoiding street clutter and minimising the risk of pedestrian routes being obstructed or narrowed, e.g. by pavement parking or by street furniture.

Ensuring high quality public spaces

- 8.7 The Core Strategy seeks to ensure that new development contributes to the creation of attractive, clean and well-maintained public places (see Policy CS14). It is essential that new streets and public spaces integrate with surrounding spaces and links, and are designed and built to a high standard, including through the use of good quality materials. The government's Manual for Streets provides useful guidance on achieving successful public spaces, and Camden's Streetscape Design Manual sets out guidance on how to ensure works contribute to local character and distinctiveness.
- 8.8 Where developments generate the need for works to road, highways and adopted public spaces, these should be funded by the developer (see CPG8 Planning obligations for transport provision) but carried out by the council in order to ensure consistent high standards of implementation and materials in streets and public spaces. In line with policy DP21 of the Camden Development Policies, all new pedestrian areas and footpaths are required to be constructed to a standard that is considered appropriate for adoption by the relevant Highway Authority.

Street clutter

Excessive use of road signs, bollards and lampposts leading to an untidy street environment.

Ease of pedestrian movement

- 8.9 Footways should be wide enough for two people using wheelchairs, or prams, to pass each other. We seek to maximise the width of footways wherever possible. The Camden Streetscape Design Manual sets out minimum widths for different kinds of footways.

Wayfinding

The process of navigating or defining a path through an environment.

- 8.10 Policy DP21 of the Camden Development Policies document states that we will expect works affecting highways to avoid unnecessary street clutter. Design of footways should not include projections into the footway, unnecessary and cluttered street furniture or other obstructions. Any minimum standards for footway widths should not be used to justify the provision of unnecessary street clutter or reduction in footway width.

The Council will generally resist proposals that involve the opening of doors into footways as they raise safety concerns, and can obstruct pedestrians.

- 8.11 Footways should be designed with frequent and convenient road crossing points for pedestrians. The detailed design of edges, crossings and gradients should take into account the need for the maintenance of minimum pavement widths, ease of movement and wayfinding, and appropriate measures for those with visual impairments and mobility difficulties. The Camden Streetscape Design Manual and DETR 'Guidance on the use of Tactile Paving Surfaces 1998' provide useful guidance which should be used to inform the design of edges, crossings and gradients.

Tables and chairs

- 8.12 The Council will sometimes licence the placing of tables and chairs on the footway in association with adjacent cafes and similar uses. The area where tables and chairs may be placed must be designated and must not interrupt the area of footway for pedestrian movement. The licence will specify permitted hours, after which the removal of tables and chairs will generally be required. Further guidance on tables and chairs is provided in CPG5 Town centres, retail and employment.

Lighting, signage and street furniture

- 8.13 Footways should be well lit and well signed, but with care to avoid light pollution and obstructions. Wherever possible, lighting and signs should be placed on buildings or existing street furniture to minimise footway clutter. Please also see paragraphs 7.17 to 7.22 on Legible London below.
- 8.14 The installation of seating, bus shelters, litter bins and cycle parking is encouraged in association with new footways provided that it will improve the pedestrian environment, and the use of sustainable modes of transport. However, they should be positioned so they do not interrupt the minimum area of footway designated for pedestrians. If possible, cycle stands (and cycles parked at them) should be wholly clear of the footway.

Footpaths that are not alongside roads

- 8.15 Footpaths independent of roads can be beneficial in terms of directly following the most direct routes for pedestrians and creating pleasant environments. However, great care is needed to provide security for pedestrians and discourage anti-social behaviour. Designs should consider:
- lighting;
 - natural overlooking from adjacent buildings;
 - maintaining visibility over the full stretch of the route between roads;
 - the appropriateness of planting; and

- avoiding features that could conceal assailants.

Pedestrian and vehicle shared surfaces

- 8.16 Policy DP17 of the Camden Development Policies states that we will seek shared surfaces in appropriate circumstances and where it will be safe for all users. Safety and accessibility for all will be examined thoroughly in any shared surface proposal.

Shared surface

A highway where distinction between pedestrian and vehicle areas has been removed or reduced and sends a strong signal that the whole of the highway space is open equally to all users.

- 8.17 Where shared surfaces are used, a combination of other traffic management measures should also be used to reduce vehicle speeds to 5-10 mph. Measures to reduce vehicle speeds should not limit visibility for pedestrians and vehicles, and must not prejudice safety. Further measures to promote safety include
- the removal of parked vehicles from the shared surface to avoid potential conflicts with children at play; and
 - provision of clear routes and surface textures to assist orientation of people with visual impairments.

Legible London wayfinding signage

- 8.18 Legible London was set up by Transport for London (TfL) in partnership with London boroughs to create a standard pedestrian wayfinding and signage system for central and inner London. It is a map-based system which gives users a good understanding of the surrounding area and encourages them to choose their own route to a specific destination.
- 8.19 Legible London signage is supported in Camden's Core Strategy Policy CS11 as a key element of Camden's approach to promoting walking in the borough. It has also been adopted by other London boroughs and thus provides consistent pedestrian signage across central and inner London.
- 8.20 The Legible London standard has been adopted by Camden and all new signs on the public highway should be of a Legible London type. The Council will also seek Legible London signage on private land, where appropriate.
- 8.21 TfL's Legible London programme currently covers the Central London area and we will extend the Legible London scheme throughout the borough, prioritising key destinations and busier areas, such as our town centres (see Core Strategy Policy CS11 paragraph 11.11). We will seek on-site provision of Legible London signage in these areas as appropriate, and on developments that contain:
- key routes to or through the site;

- decision points, arrival points and places where pedestrians are likely to gather;
 - complex spaces and areas outside civic spaces and public buildings.
- 8.22 Where relevant, sign types and quantities should tie into any relevant area strategies produced by the Council, in partnership with TfL.
- 8.23 As well as on-site provision, developments will also be expected to provide contributions to the Legible London in other locations, where appropriate, in order to mitigate the increased level of activity their development generates (see transport section of CPG8 Planning obligations).

Highway authority approval

- 8.24 Works to streets and public spaces also require separate approval from the relevant highway authority (usually Camden council). You are advised to contact our Highways department as soon as possible to discuss the approach to and proposed works to streets and public spaces.

Further information

- 8.25 In addition to Camden's Core Strategy, Development Policies, the Camden Streetscape Design Manual and other sections in this guidance, reference should be made to the following guidance:
- Manual for Streets, DfT, 2007
 - Residential roads and footpaths: layout considerations – DfT Design bulletin 32 (2nd edition), HMSO 1992
 - Guidance on the use of tactile paving surfaces, DETR 1998 - this can be viewed on the 'transport infrastructure, pedestrians, wheelchair and scooter users' pages in the 'access for disabled people' section of: www.dft.gov.uk

9 Cycling facilities

KEY MESSAGES

This section includes guidance on:

- The implementation of our minimum cycle parking standards for new development;
- The design and layout of cycle parking; and
- Cycle hire and cycle stations.

9.1 This section provides guidance on meeting cycle parking standards in an effective way, so that cycle parking is convenient and secure, and users of a development are more likely to use bicycles to travel to and from the site.

9.2 It relates to Core Strategy Policy CS11 – *Promoting sustainable and efficient travel* and policies DP17 – *Walking, cycling and public transport* and DP19 – *Parking standards and limiting the availability of parking* of the Camden Development Policies. It should be read in conjunction with Development Policies Appendix 2 – Parking standards.

When does this apply?

9.3 This guidance applies to:

- Applications which involved the creation of one or more additional dwellings;
- Applications which proposed additional floorspace of 500 sq m or more; and
- Applications which are likely to significantly increase the demand for people to cycle to the site.

How do we implement our cycle parking standards?

9.4 Numerical standards for cycle parking spaces are introduced by policy DP18 of the Camden Development Policies, and set out in detail in Development Policies Appendix 2. These standards are applied at a threshold of 500 sq m in most cases. Throughout the standards, the stated number of spaces relates to the number of bicycles to be accommodated, not to the number of stands.

9.5 Where a development crosses the threshold, requirements apply to the entire floorspace, not only the floorspace above the threshold. For example, at a new leisure development, 1 visitor cycle parking space per 250 sq m is required from a threshold of 500 sq m. This means that no requirement applies to a facility of 400 sq m, but 4 visitor spaces are required for a facility of 1,000 sq m.

9.6 Thresholds and standards are given as a gross floor area (GFA) relating to the development as a whole, and are not intended to be applied

separately to individual units where a development is subdivided into smaller units. Thus, space for cycles may be required for small premises (under 500 sq m) which form part of a larger development.

- 9.7 Table 6.3 of the London Plan sets out additional cycle parking standards and states that additional cycle parking provision will be required for larger (C3) residential units.

Location, design and layout of off-street cycle parking

- 9.8 Cycle parking should be provided off-street, within the boundary of the site. Cycle parking needs to be accessible (in that everyone that uses a bike can easily store and remove a bike from the cycle parking) and secure (in that both wheels and the frame can easily be locked to the stand). Security is a critical concern in the location, design, enclosure and surveillance of all cycle parking. The table below provides detailed guidance on the location, design and layout of cycle parking for various groups of cyclists.

Location of off street cycle parking

General

- Cycle parking outside buildings should be positioned near entrances and where frequent surveillance is possible. For short stays, the parking should be sited within 25 metres of building entrances. For stays of over an hour, the parking should be sited within 50 metres of building entrances.
- All cycle parking, including all parts of the parked cycles, should be clear of routes needed for pedestrian movement.
- The route to cycle parking from street level should be step free. cycle parking inside buildings should be at the entrance level of the building or accessible by a ramp or lift from street level that can accommodate a bike.

Parking for visitors

Parking for visitors should be clearly visible or clearly signed from the public highway, and should be near building entrances

Parking for employees (and other long stay parking)

Parking for employees (and other long stay parking) should be provided either within the building, or otherwise protected from the weather. Consideration should be given to providing lockers and showers for cyclists. For larger development this would be expected and would be a requirement of a Travel Plan (see section 2 of this guidance concerning Travel Plans).

Parking for residents

Parking for residents should be within the building. Parking for a resident may take the form of a space within an individual dwelling provided that the space is close to the door of the dwelling, and access to the dwelling is level, or by a ramp or lift that can accommodate a bike.

Design and layout of cycle parking: Sheffield and “Camden” cycle stands

The Council recommends the use of either “Camden” or Sheffield for the provision of off-street cycle parking, as they meet the Council’s requirements in terms of accessibility and security, provided they are laid out correctly.

- The “Camden” stand is a new form of Sheffield Stand, which is now used for all new cycle parking installed on Camden’s public highway. Developers are encouraged to use it in place of the Sheffield stand, although the Sheffield stand is still acceptable. The Council’s Public Realm and Transport team can advice on purchasing “Camden” stands as they are not as widely available as the Sheffield stand.
- The Sheffield Stand is the most common type of cycle stand used in the public highway. It is recommended for use along with Josta two-tier cycle parking;

Annex 1 provides more detailed guidance on the design and layout of “Camden”, Sheffield and Josta stands.

We are willing to consider other forms of cycle parking, however you must meet our accessibility and security requirements, details of which can be obtained from the Council’s Public Realm and Transport team. Generally, designs that require cycles be lifted into place or provide insufficient opportunity to lock the cycle will not be acceptable.



The London Cycle Hire Scheme

- 9.9 The London Cycle Hire Scheme is a public bicycle sharing scheme for short journeys in and around central London. Users can pick up a bike from a docking station, use it for short journeys, then drop it off at any docking station, ready for the next person.
- 9.10 Whilst the cycle hire scheme is currently focused around central London, the Mayor of London is investigating its expansion. The Camden Core Strategy states that we will seek to ensure that the scheme is extended to key destinations across the borough, including our town centres (see Core Strategy paragraph 11.13).
- 9.11 Where appropriate, developments close the area covered by the London Cycle Hire Scheme will be expected to contribute towards the scheme,

where justified as a result of increased trips generated. Contributions could include:

- a financial contribution towards cycle hire facilities. The amount sought will be based on the number of additional trips that are generated by the scheme;
- provision of space on-site to accommodate new cycle hire docking stations, in larger developments where there is space and the location is suitable. Transport for London (TfL) is producing a set of guidance for developers regarding specifications and design requirements for docking stations due to be released in 2011.

9.12 Contributions sought will relate both to the individual impact of a scheme and to any cumulative impact of a number of schemes in the same area.

Cycle stations

9.13 Cycle stations provide a secure managed area for cycle parking. The Camden Core Strategy promotes the provision of cycle stations as part of an effort to increase the availability of cycle parking in the borough (see paragraph 11.13 of the Core Strategy), and we intend to create a network of publically accessible cycle stations across the borough.

9.14 We will seek the provision of cycle stations in locations where it will be possible to attract a sufficient number of users. Suitable locations include:

- town centres and the central London area;
- transport interchanges;
- large commercial developments;
- residential areas - linked to new and existing residential development of a suitable scale; and
- larger health and education facilities.

9.15 Where developments generate an increased level of activity they will be expected to provide contributions towards the provision and maintenance of nearby cycle stations, in order to mitigate the effects of the increased number of journeys.

9.16 We will also seek on-site provision of cycle stations as part of larger developments in suitable locations. On-site provision of cycle stations can incorporate a development's cycle parking requirements for visitors (as set out in our parking standards), but should also include extra provision for the wider public. Parking provision for employees and residents of a development, as set out in our parking standards, should be provided separately in order to ensure that they retain the appropriate number of spaces to meet the demand that they generate.

Design of cycle stations

9.17 As a minimum, cycle stations should incorporate indoor, sheltered standard cycle parking (e.g. Camden or Sheffield type cycle stands) with

controlled access to the indoor area, and lighting. Cycle stations can incorporate a variety of other features including automated cycle locks, changing facilities, lockers, toilets and showers. Access to and from the cycle station by bike must be safe and convenient and accounted for within the space.

9.18 The Camden Cycle Stations Programme - Review of Best Practice (March 2009) provides information on best practice in the provision of cycle stations. Features that contribute to a successful cycle station include:

- Being located not more than 100m from the target destination, with shorter stays requiring shorter distances;
- Good surveillance by staff, other users and passers-by.
- Effective maintenance and management
- Clear and unambiguous signing to and within the cycle station.

Further information

9.19 In addition to the guidance provided in Annex 1 below (which includes details on the layout of off-street cycle parking), reference may also need to be made to the Camden Streetscape Design Manual. The manual contains dimensions for on-street cycle parking and the widths required for unobstructed pedestrian routes.

9.20 Other supporting documents include:

- Forthcoming TfL Design and specification of cycle hire scheme
- Forthcoming TfL Guidance on Cycle Stations
- Camden Cycle Stations Programme - Review of Best Practice (March 2009)

9.21 London Cycle Network Design Manual (London Cycle Network Steering Group, March 1998)

Annex 1 – Sheffield Stand Cycle Parking

9.22 This Annex describes in detail how to lay out Sheffield stands. It also can also be applied to the layout of “CaMden” stands.

9.23 The "Sheffield Stand" refers to a common design of cycle parking made from a tubular steel loop, approximately 50mm to 75mm in diameter, that is fixed to the ground (either bolted through a baseplate or set in concrete). Each Sheffield Stand can accommodate two bicycles, one either side, provided there is sufficient clearance next to the stand and sufficient circulation space so all cycle parking spaces can be accessed

9.24 The CaMden Stand is similar to the Sheffield Stand but is in the shape of a rounded “M” rather than a simple loop. This is designed to encourage users to lock both wheels and the frame to the stand, rather than just the top tube / frame.

Figure 3. Sheffield Stand Elevation

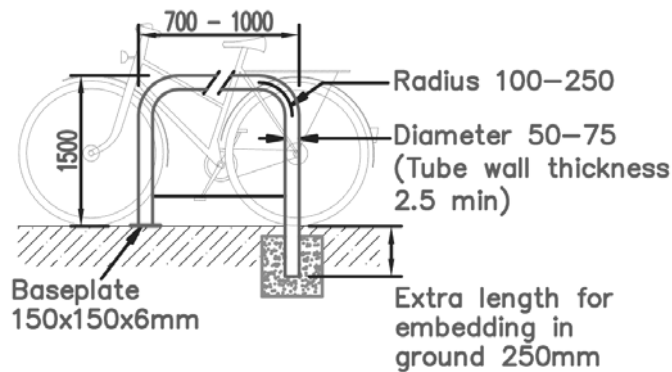
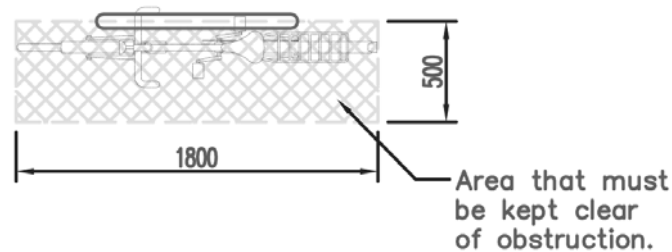
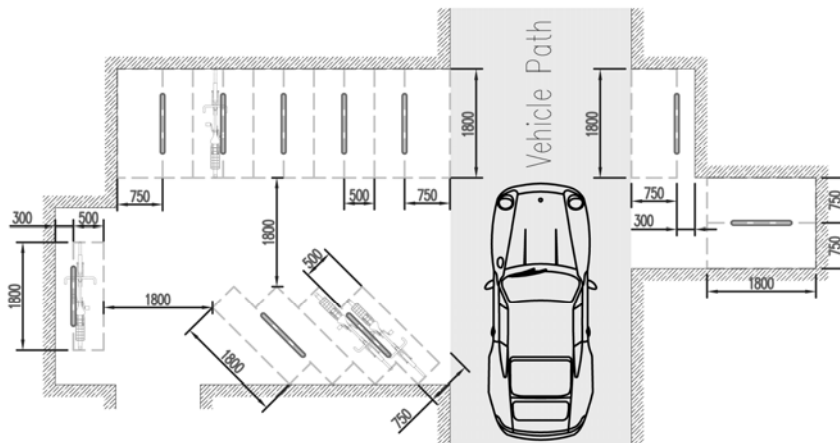

Figure 4. Sheffield Stand Plan



- 9.25 For adjacent stands, an area of at least 1800mm by 500mm next to the stand (measured from the centre line of the tube), must be kept clear for each cycle parking space to allow room for the cycle and working space for locking the bike to the stand. However, if a stand is next to a physical obstruction, such as a wall or a vehicular path, there must be at least 750mm between the stand and the physical obstruction to enable both sides of the stand to be used. If a stand is to be placed close to a wall or other physical obstruction so that only one side of it can be used (i.e. only one cycle can be locked to it), there must be at least 300mm between the stand and the physical obstruction.
- 9.26 Aisles around the cycle store must be at least 1800mm in width. An example cycle store showing various layout options is shown below. Note that the area to be kept clear does not actually have to be marked on the ground, but is shown in outline for clarity.

Figure 5. Cycle stand siting



Josta Two-tier Cycle Parking

- 9.27 The Josta two-tier cycle parking system (or similar) is generally able to accommodate approximately twice as many cycles per square meter of floor space as Sheffield stands. It also still meets the Council's requirements for accessibility and security, but requires a ceiling height of at least 2500mm.
- 9.28 With a ceiling of at least 2500mm the stands can be placed 650mm apart, i.e. $X = 650\text{mm}$ in the diagram below.

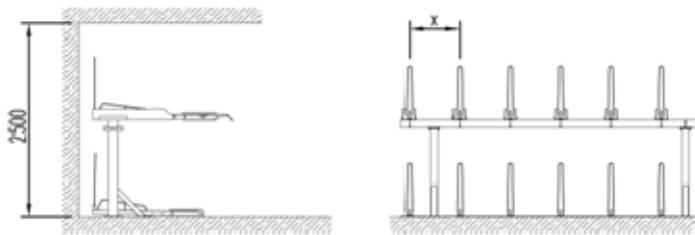

- 9.29 With a ceiling of at least 2700mm the stands can be placed 400mm apart, i.e. $X = 400\text{mm}$ in the diagram below.

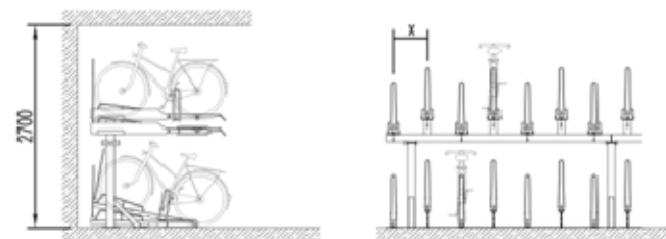

- 9.30 In order to enable the top tier to be used, at least 2500mm of clearance in front of the stand, measured on a line at the same angle at which the top tier stands are extended (see diagrams below), is required between rows of stands, walls or other obstructions.

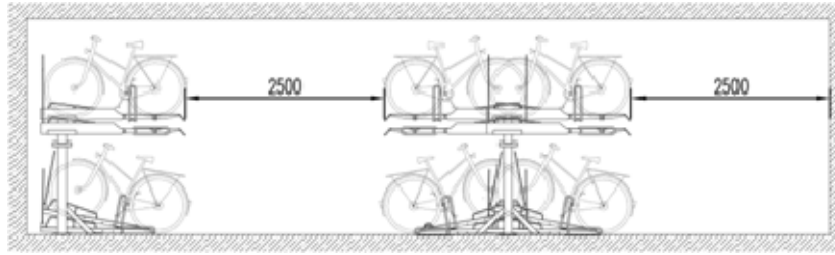

- 9.31 The Josta stands can be arranged at different orientations (angles) provided there is 2500mm of clearance in front of the rack to remove cycles from the top tier (as described above) and aisles around the cycle store at least 1800mm in width. Examples, with minimum distances are shown below. “X” indicates the spacing between stands, which depends on the ceiling height as described on the previous page.

Figure 6. Josta Stand minimum siting dimensions

