

# Planning, Design and Access Statement

In support of a planning application for the installation of a Santander Cycles docking station on the carriageway on:

**Coram Street near the junction with Woburn Place, WC1N in the London Borough of Camden**

Date: October 2015

TfL reference: CA169







# Executive Summary



Transport for London (TfL) has coordinated the implementation of comprehensive cycle hire scheme in London on behalf of the Mayor of London. Cycle Hire was launched by the Mayor in July 2010 and to date almost 40 million journeys have been made.

The Scheme provides safe and convenient public access to cycles for short trips, especially for those who do not usually cycle or own a bicycle. It promotes the Mayor's vision for a sustainable and low emission transport system within London by actively encouraging cycling. Cycle Hire is set out in the Mayor's cycling strategy (Cycling Revolution London, 2010), along with other TfL initiatives, which will bring significant social, environmental, health and financial benefits to the Capital.

There are now more than 11,500 bicycles operating from approximately 750 docking stations, following the expansion of the scheme westwards, to cover the London Borough of Hammersmith and Fulham and the London Borough of Wandsworth. TfL is currently intensifying the number of docking points in the existing zone. This will improve the scheme by augmenting bike availability and making its network more robust, which will increase customer satisfaction. It will also guarantee that the Cycle Hire network is adaptable and reacts to the changes in population density and in demographics.

This Statement incorporates a Design and Access Statement as well as providing an appraisal of relevant planning policy. It demonstrates how TfL, along with its partners, has had special regard for the design and location of the docking stations. The design of the street furniture, in particular the terminal design, evolved through consultation with the host boroughs, the Royal Parks, and access groups. This collaborative process has led to a high quality docking station design which is adaptable to and visually appropriate in a variety of locations across London.

This Statement is provided in support of a full planning application for the installation of a standard docking station on the carriageway on Coram Street near to the junction with Woburn Place, WC1N in the London Borough of Camden.

This Statement concludes that the proposal is supported by, and is consistent with, the relevant planning policy and guidance within national and local development plans and strategies. The docking station will be appropriate within the existing local environment and as part of the wider cycle hire scheme will contribute to an innovative and sustainable transport system in London.



# Contents

## Part 1: Cycle Hire

1.1	Overview	2
1.2	Cycle Hire Scheme	3
1.3	Site Selection Criteria	5

## Part 2: Design Statement

2.1	Docking Station Design	6
2.2	Implementation	8
2.3	Operation	9
2.4	Maintenance and redistribution	9

## Part 3: Access Statement

3.1	Inclusive Access	10
3.2	Pedestrian Circulation	10

## Part 4: Planning Policy and Guidance

4.1	Introduction	11
4.2	The Development Plan	11
4.3	Other Planning Documents	13
4.4	Streetscape Design Guidance	15

## Part 5: The Application

5.1	Site Characteristics	16
5.2	The Proposal	18
5.3	Key Issues	19
5.4	Application Summary	21







*Cycle Hire docking stations (clockwise from top left):*

- on a footway build out in London Borough of Southwark;
- on the carriageway in City of London;
- in Hyde Park, in City of Westminster.





# 1. Cycle Hire

## 1.1 Overview

In February 2015 Santander replaced Barclays as the official sponsor of the London Cycle Hire Scheme.

As stated in the Executive Summary, TfL has secured funding for intensification of the Cycle Hire Scheme. The addition of docking points in key hotspot areas will contribute directly to the TfL and Mayoral goals of ensuring more and safer cycling, by further reducing barriers to cycling. With improved availability on and near Quietways and Cycle Superhighways there is great potential to increase the levels of commuting using the bicycle to and from central London. Cycle Hire intensification will also reduce the number of redistribution vehicles on the road and reduce the frequency of visit to areas which are difficult to maintain.

This Statement is provided in support of an application for the installation of a Santander Cycles docking station on the carriageway on Coram Street near the junction with Woburn Place in the London Borough of Camden.

Figure 1.1 shows an existing site before and after the installation of a cycle hire docking station.

Part 1 of this Statement provides background to the scheme, details of the docking stations and information regarding the implementation of the proposal. Part 2 explains the design principles for the scheme. Part 3 is an access statement which explains how mobility and access issues have been addressed. Part 4 provides a review of planning policy and guidance. Part 5 describes the planning application at this location.



Figure 1.1: An existing site before and after installation of a cycle hire docking station



### 1.2 Cycle Hire Scheme

Cycling within London is experiencing rapid growth. It is estimated that there has been an 173 percent increase in the number of cycling trips on London’s major roads since the year 2001 with around half a million cycle trips currently taking place in London every day. The Mayor has set a target to increase the number of cycling trips within London by 400 percent by 2026, and more generally, improve conditions for cyclists.

To help achieve this growth TfL was tasked with implementing a cycle hire scheme within London. The scheme allows people to hire a cycle from a docking station, and return it to either the same or another docking station. To ensure the adequate availability of docking points and cycles for those hiring and returning cycles, docking points outnumber bicycles by 70-80%.

The scheme was developed in collaboration with the Royal Parks and the following nine London Boroughs:

- London Borough of Camden;
- London Borough of Hackney;
- London Borough of Islington;
- Royal Borough of Kensington and Chelsea;
- London Borough of Lambeth;
- City of London;
- London Borough of Southwark;
- London Borough of Tower Hamlets; and
- City of Westminster.

The scheme was launched in July 2010, and, following the success of the first two phases, the Mayor announced a commitment to expand the zone westwards to include the London Borough of Hammersmith and Fulham and the London borough of Wandsworth. In addition to expanding the scheme area, the Cycle Hire Expansion and Intensification (CHEI) phase also increased the number of docking points in the existing zone to meet the additional demand generated by the expansion.

There are now more than 11,500 cycles across approximately 750 docking stations and to date almost 40 million cycle journeys have been made.

A survey of the scheme conducted in 2013 (*Cycle Hire Casual Users Profile*, TfL, 2013. Base 1,109 respondents) indicates high levels of customer satisfaction, in which 72% rated the scheme as 8 or more out of 10, and most would recommend it to a friend. Most journeys have been under 30 minutes in duration and are typically for leisure use. Most users carry out a journey at least once a week. Cycle Hire prompted almost 70% of people to start cycling in London, indicating that the scheme has been successful in spreading the benefits of cycling to a new group of people and increasing the number of cycling trips in London.

The cycle hire scheme covers the area shown in Figure 1.2.

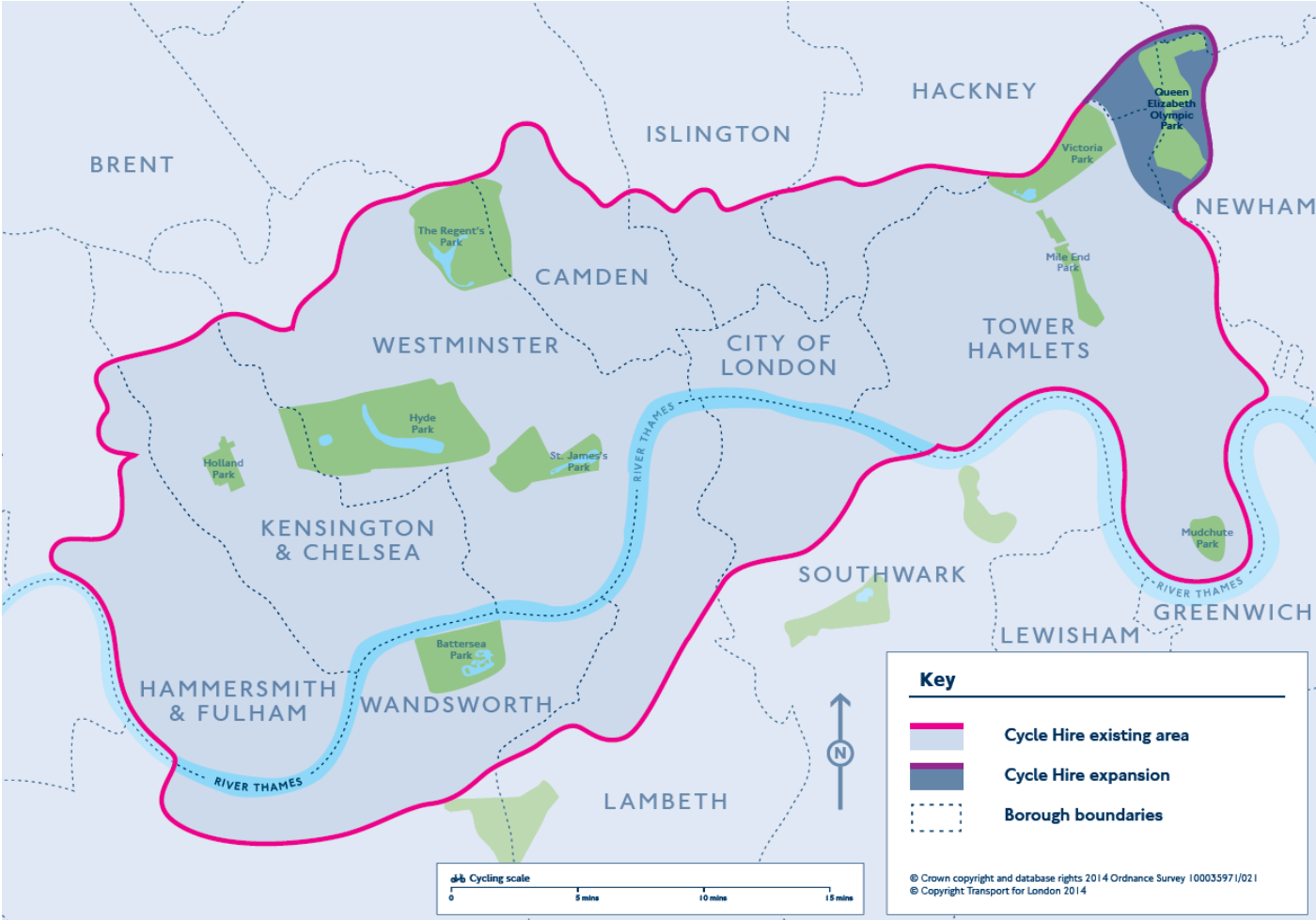

Figure 1.2: Cycle Hire scheme area





Although the cycle hire scheme is already established in Camden, it is important to consider the existing arrangements and to add docking stations in key hotspot areas in order to ensure there is growth in usage of the scheme and to improve customer satisfaction. This is important as although customer satisfaction is at its highest point yet, one of the biggest sources of dissatisfaction is bike/space availability. Users want docking points and cycles to be available when and where they are required.

Increasing the density and improving the locations of Cycle Hire is essential for keeping up with the ever increasing demands put on all modes of transport in London caused by ever increasing population growth. The intensification programme will ensure that Cycle Hire docking points are made available to the greatest number of people possible by locating docking points near to new housing, leisure and office developments.

In preparing for the expansion and intensification of the scheme, TfL has worked closely with the partner boroughs.

Serco Group Plc (Serco) was appointed as the Scheme Operator in 2009. They worked with the Public Bike System Company (Montreal) to develop the cycle hire scheme in London, based upon the 'BIXI' System which successfully operates in Montreal (Figure 1.3). Serco design and build sites, and operate and maintain the scheme on TfL's behalf. Their contract includes the following:

- design and implementation of business support operations and maintenance processes;
- maintenance of assets;
- re-distribution of cycles around the scheme area; and
- customer service centre including the website and user communications.



Figure 1.3: BIXI docking station, Montreal

**Scheme Benefits**

Scheme benefits, both existing and anticipated long term benefits, include the following:

- a modal shift from other forms of transport to cycling. In the 2013 survey of Cycle Hire users, 41% of the journeys by scheme cycles were undertaken previously by London Underground. Other modes include 36% by walking, 28% by bus, 2% by taxi.
- encouraging additional cycle trips in London, and greater uptake of cycling in general. The 2013 survey shows the scheme is attracting those who did not previously cycle;
- reduced journey times for users. In the 2013 survey, this reason was reported by 38% of respondents;
- improved health of users. This was the reason for switching given by 30% of users;
- encourage a broader cross-section of the population to try cycling and experience the benefits of low-cost and active travel; and
- helps to remove a number of perceived and real barriers to cycling uptake, such as the expense of buying a bicycle, the fear of bicycle theft, the difficulty of storing bicycles, the lack of opportunities to try cycling for the first time or to improve cycling skills, and the difficulty of finding secure places to park bicycles.

The scheme also:

- allows a greater choice of public transport options;
- provides the fastest option for many short journeys;
- provides a transport mode that is available 24 hours a day, 365 days a year;
- encourages local trips within London by bicycle;
- offers a sustainable and low emission form of transport;
- offers a way to keep fit and lose weight;
- provides a good way to get to know one's neighbourhood better; and
- provides an inexpensive transport option.





### 1.3 Site Selection Criteria

A detailed site search to select appropriate sites for docking stations in London has been undertaken by TfL and the host boroughs, based on site selection criteria developed in collaboration with the scheme partners. The criteria takes into account relevant local planning policies, supplementary design guidance, and TfL's own standards and design guidance. The key criteria includes:

- no loss of trees and avoidance of grassed areas;
- minimal relocation of existing street furniture, including existing cycle stands;
- sufficient space to maintain clear pedestrian/vehicular paths/access;
- safe and secure areas with good natural surveillance, street lighting and/or where appropriate, close circuit television cameras (CCTV);
- close proximity to where people live and work, and attractors such as tourist destinations, and community and leisure facilities;
- avoidance of areas of high pedestrian congestion and areas known to be unsuitable for cyclists; and
- a presumption against sites where the docking station would have a detrimental impact on sensitive townscapes and/or the setting of heritage assets.

Each site is assessed on its merits having regard to its location and the surroundings. Not all of the above criteria are relevant to every site.



# 2. Design Statement

## 2.1 Docking Station Design

Each docking station comprises a terminal and docking points. The layout of each docking station and number of docking points is tailored to each site, depending on the available space, the proximity to buildings, the presence of street furniture and other relevant criteria listed above. Docking stations are located on footways, carriageways and other hard-standing areas.

### The Terminal

The terminal (Figure 2.1) controls the locking and release of scheme cycles, enables payment of user tariffs, allows print out of journey records, provides information about the scheme and provides way-finding mapping of the local area and the location of other docking stations.

The terminal is four sided with a maximum height of 2.4m. Two faces of the terminal have a maximum width of 0.5m and the other faces have a maximum width of 0.35m. The TfL cycle hire logo (roundel) is located at the top of each face of the terminal, along with the docking station name. The 0.5m wide faces of the terminal each comprise way-finding maps and information panels (Faces A and C as shown in Figure 2.1).

Depending on the expected usage of the docking station, and whether it is located on the carriageway or footway, one (Face B) or two (Faces B and D1) of the 0.35m wide terminal faces will comprise a screen, keypad, and membership key reader. Where only one face of the terminal is used for payment, the remaining face will display additional information (Face D2). The face of the terminal that is orientated toward the carriageway (Face D1 or D2) will incorporate traffic regulations signage to avoid the need for a separate traffic sign.

The terminal colour palette comprises:

- body - dark blue (Pantone 296c);
- base, trim and cap - silver grey (RAL 9007);
- roundel circle - M: 93, Y: 100; and
- roundel bar - NCS S 0500-N (white).

The terminal is constructed from the following materials:

- top cap, housing and main panels – cast aluminium with powder coat finish and a clear graffiti resistant coating; and
- information panels - toughened glass.

The TfL roundel is not illuminated. The way-finding maps and information panel can be illuminated on demand to improve visibility for users in poor light conditions.

The top of the terminal is curved to mitigate the collection of litter. It has also been designed to enable later installation of a solar panel if solar technology improves and sufficient power could be produced to operate the docking station.

The footprint of the terminal and its associated circulation area is generally a minimum of 2.0 metres by 2.0 metres, allowing ample space for people to use the terminal without causing obstruction to pedestrians. The exact location of the terminal within the circulation area is dependent on site characteristics, access to the required connection to electricity, and the need to retain clear pedestrian paths.

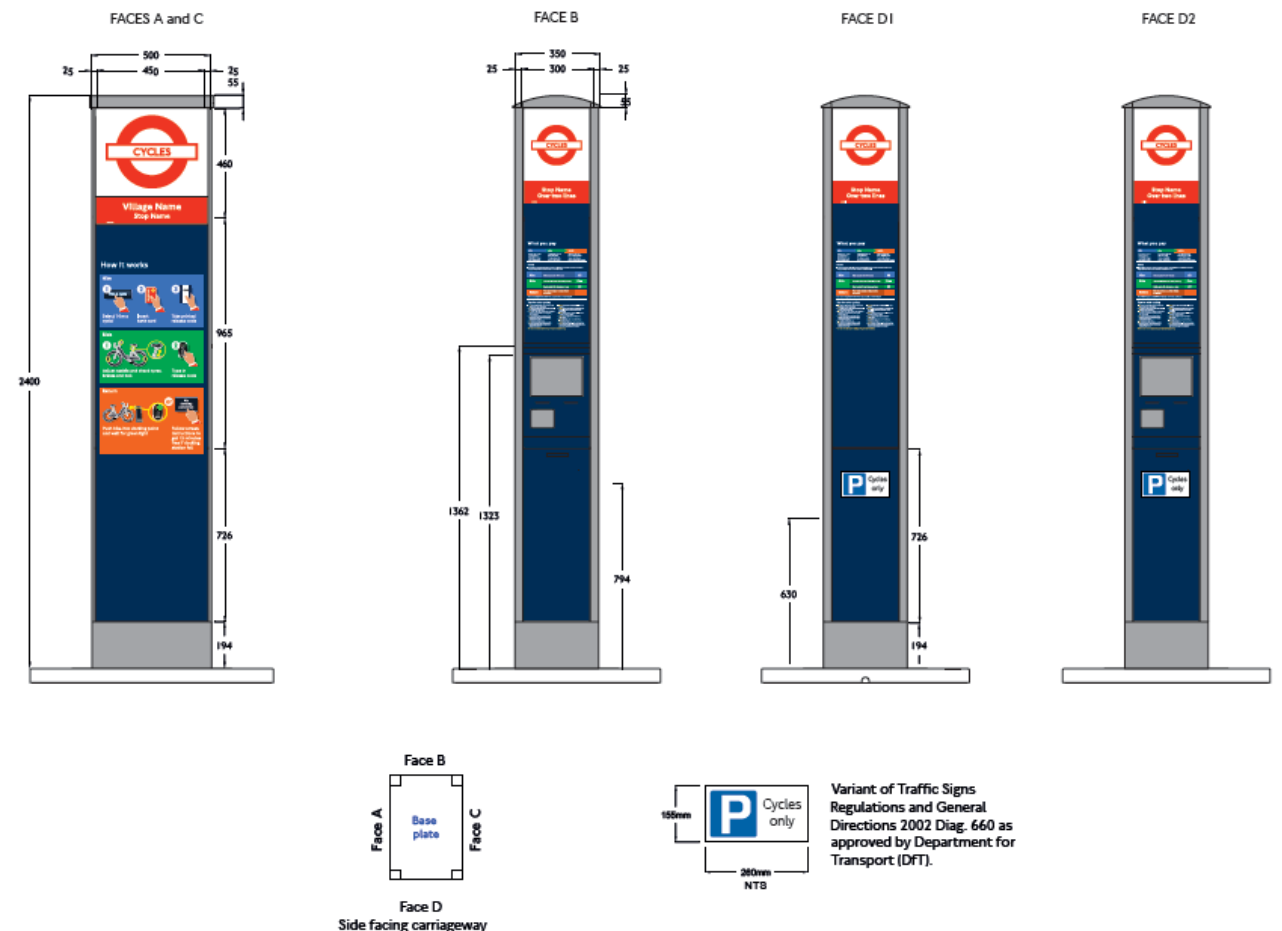

Figure 2.1: Terminal design





**The Docking Points**

The docking points for the docking of scheme cycles, will be contained within a defined area (or areas) adjacent to the terminal. The dimensions of the docking point area(s) will vary between docking stations depending on the number of cycle docking points, the way in which they are laid out and the site constraints and characteristics.

The docking points each secure one cycle (Figure 2.2) and are laid out to provide a minimum of 0.75 metres between the centre point of the cycles once docked. The docking points area will be designed so that the cycles will be angled at either 45 or 90 degrees within the site. The cycle will be wheeled into the docking point where it will slot firmly into a secure locking cassette. Each locking cassette has a membership key reader to allow quick release of cycles for cycle hire members.



Figure 2.2: The docking point, with one scheme cycle

Docking points each have a maximum height of 0.8 metres and maximum dimensions of 0.3 x 0.3 metres (Figure 2.3). The tops of the docking points are sloped to avoid litter accumulation and allow rain water to drain.

Docking points mirror the terminal in colour, being predominantly dark blue with silver inner panels, locking cassette and base, as outlined below:

- body – dark blue (Pantone 296c);
- inner panels, locking cassette, and base – silver grey (RAL 9007); and
- roundel – M:93, Y:100.

Docking points are constructed from cast aluminium with a powder coated finish and a clear graffiti resistant coating.

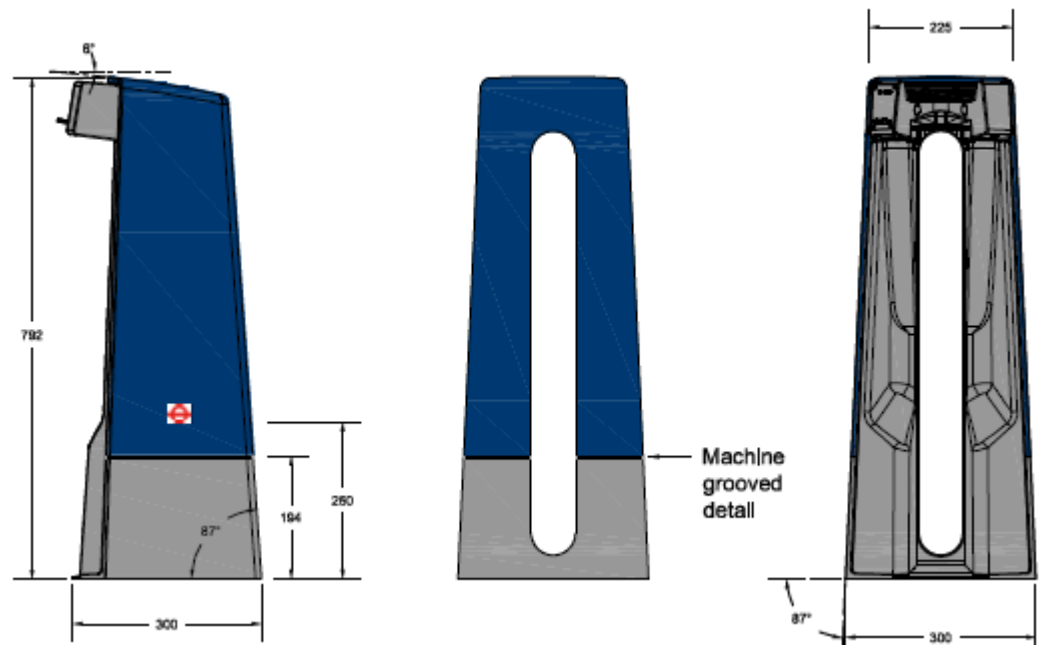

Figure 2.3: Docking point design



**Foundations**

The terminal foundations have a maximum depth of 0.45m (including the surfacing) and a maximum sub-surface plan area of 0.8 x 0.8 metres. The terminal is secured to a square foundation box.

The docking point foundations are 0.225 deep and 0.7 metres wide, and are constructed as a trench extending the length of the docking points area. Excavation will not exceed a depth of 0.318 metres from finished ground level. Figure 2.4 provides a cross section for a footway site. The docking points are each secured to a square foundation box (Figure 2.4), and its corners will be visible around the edges of the docking points (Figure 2.5). The cover of the foundation box will be finished to a high standard with a non-slip surface.

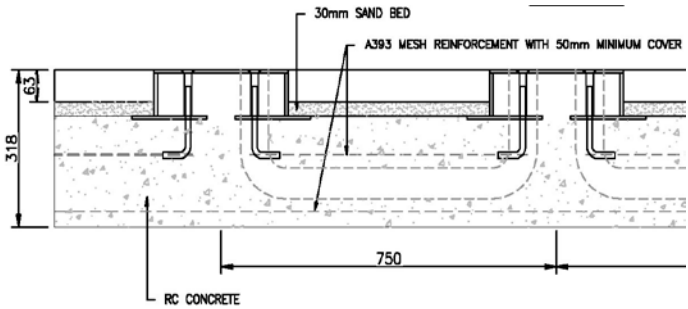

Figure 2.4: Cross-section of docking point foundations (not to scale)

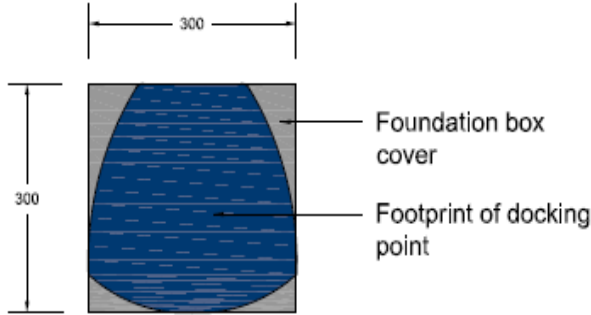

Figure 2.5: Footprint of docking point at base (not to scale)

**2.2 Implementation**

In addition to planning permission, other consents and orders, including a Traffic Regulation Order, will be sought for all docking stations. All preparatory works, including the installation of ducting to provide power and communications, will be undertaken prior to the installation of the docking station. Where the site is not located on part of the TfL road network, the works will be undertaken with the agreement of the relevant borough or other land owner.

Construction will normally take place over approximately 8-10 working days, and a 10 day New Roads and Streetworks Act permit will be sought to allow for site set-up and appropriate reinstatement.

Since the foundation depth for the terminal and docking point structures will be a maximum of 0.45 metres (including surfacing), the duration of excavation activities will be limited.

Within the 8-10 working days, the street furniture (terminal and docking points) is also installed and the equipment tested. This involves connecting the electrical cables and bolting the street furniture to the foundations. These are relatively quiet operations .





## 2.3 Operation

The docking station will be available for use 24 hours a day, seven days a week, with the main periods of use during weekday mornings and early evenings. The majority of patrons using the docking station are members who do not need to be at the station for long as they simply insert their membership key into a docking point to release a cycle. Casual users will register at the terminal and receive a cycle release code which they will enter using the touch sensitive numbered pad located above the key slot on the docking point.

The noise level associated with using the terminal is comparable to bus patrons using a ticket machine located at a bus stop, or to people viewing Legible London way-finding maps. The locking mechanism used to secure cycles to the docking points utilises innovative technology developed for the Public Bike System in Montreal. The design has been carefully optimised to ensure that the risk of cycles being stolen is minimised. The docking point has been designed to guide the user to wheel the cycle into the correct position to easily engage the locking mechanism.

The locking mechanism is contained within the docking point and the progress of locking and unlocking of cycles is indicated by discrete lights on the locking cassette. The release and re-docking of the cycles is expected to occur without any discernable noise. These design features all provide a streamlined system of releasing and locking cycles that is quick, easy, and efficient.

Contractual arrangements between TfL and the Scheme Operator regarding maintenance, repair and replacement ensure the appearance of the docking station meets appropriate standards. A key objective has been to minimise the physical depreciation of the street furniture through design by, for instance, the use of curved edges on equipment and the selection of robust materials and finishes that are easy to maintain.

## 2.4 Maintenance and redistribution

Each docking station is inspected by maintenance staff at least every 14 days to ensure all equipment is fully functional and a high standard of station cleanliness is maintained. Any damage identified during this visit is repaired on site where possible or reported for follow-up action if necessary. This inspection usually occurs during daytime hours when visibility is best and by a single member of staff on a scheme cycle. Docking stations are also visited when faults or damage are reported by users. The noise generated by these activities is not anticipated to cause any disturbance.

The visit is usually by a single staff member on a scheme cycle who will assess the fault and if possible resolve it on site. Where this is not possible, an operational vehicle is directed to the station to collect and remove the equipment to the maintenance depot for repair.

The success of the scheme relies on the appropriate distribution of cycles across the network and the availability of vacant docking points at the end of each hire. The scheme network has, therefore, been designed to maximise the natural redistribution of cycles. At popular docking stations, if the site is empty or full, cycles need to be replenished or removed to allow space for Cycle Hire users to continue to successfully dock and acquire bikes.

Notwithstanding the above, it is necessary to redistribute bikes across the network in some locations, particularly where bicycles are used by commuters at peak hours between 7am and 10am. An increasing number of complaints are being made to the customer service team regarding the distribution of cycles across the network. These include being unable to hire a cycle due to the docking station being empty, or being unable to return a cycle due to the docking station being full. These are both situations that occur regularly due to the popularity of the scheme.

The redistribution of cycles across the network is carried out by a van or trailer with a ramp for efficient and quiet loading and unloading of the bikes. The redistribution vehicle is only sent to the docking station when it is required.

In most cases, unlike maintenance and repair activities, bike redistribution is best carried out at night. It takes approximately 30 seconds to unload or load a bike to or from the docking station for redistribution of bicycles. For example, if 10 cycles need to be removed or docked, then the approximate time to achieve this would be 5-10 minutes. This ensures that the servicing of the docking station minimises adverse impacts on surrounding properties.



# 3. Access Statement

## 3.1 Inclusive Access

The views of key access groups, including the Royal National Institute for Blind People, the Guide Dogs for the Blind Association and the Disabled Persons Transport Advisory Committee were taken into account in the initial development of a design of the street furniture. The resulting docking station design is accessible to all anticipated user groups.

As discussed in Section 1.4 individual docking points are 0.8 metres in height, which is sufficient to ensure that the docking points are visible to passing pedestrians. Individual docking points are usually viewed in the context of a row of other docking points, and in combination with docked cycles and a terminal, which further increases their visibility. The terminal is 2.4 metres high and is easily visible above the level of the cycles and docking points (Figure 3.1).

The way-finding mapping and information on the terminal, including that likely to be of relevance to non-cyclists, is of an appropriate height for most users, including wheelchair users. The mapping has been designed to be clear and easy to read and complies with TfL's accessibility standards. The text on the information panels also meets the appropriate standards with respect to font size and type, as well as colour contrast to background. There is push button illumination of the mapping and information panels.

The terminal incorporates the TfL roundel and a station and locality name to ensure each docking station is easily identifiable and recognisable as a part of the scheme and as a transport mode.



Figure 3.1: Double row docking station on footway

## 3.2 Pedestrian Circulation

As discussed in Section 1.3 docking station sites have been selected where there is sufficient footway or carriageway width not to cause an obstruction to pedestrians or vehicles.

Docking stations on carriageway sites are usually located against the kerb. Sufficient space has been provided on these sites to enable users to circulate around the terminal and docking points without having to step out into traffic paths. Docking stations on the footway are usually located within the street furniture zone (see Figure 3.2), or at the back of the footway. In most cases, a minimum of 2.0 metres of clear footway is retained to ensure that the docking station does not impede pedestrian movements.

The docking station is designed to maximise pedestrian circulation within and around the docking points and terminal. There is a gap between individual docking points to allow ease of cycle docking and un-docking, and pedestrian movement between the docking points when they do not contain docked cycles. Depending on site circumstances, the terminal is generally positioned within a 2.0 by 2.0 metre area to provide space for pedestrian circulation and queuing clear of the main traffic flows.

Each docking point has a scheme membership key reader enabling registered users to hire cycles without interaction with the terminal. In busy locations the terminal may have two payment points, or the docking station may have two terminals. These measures minimise queuing and help to maintain a clear footway.

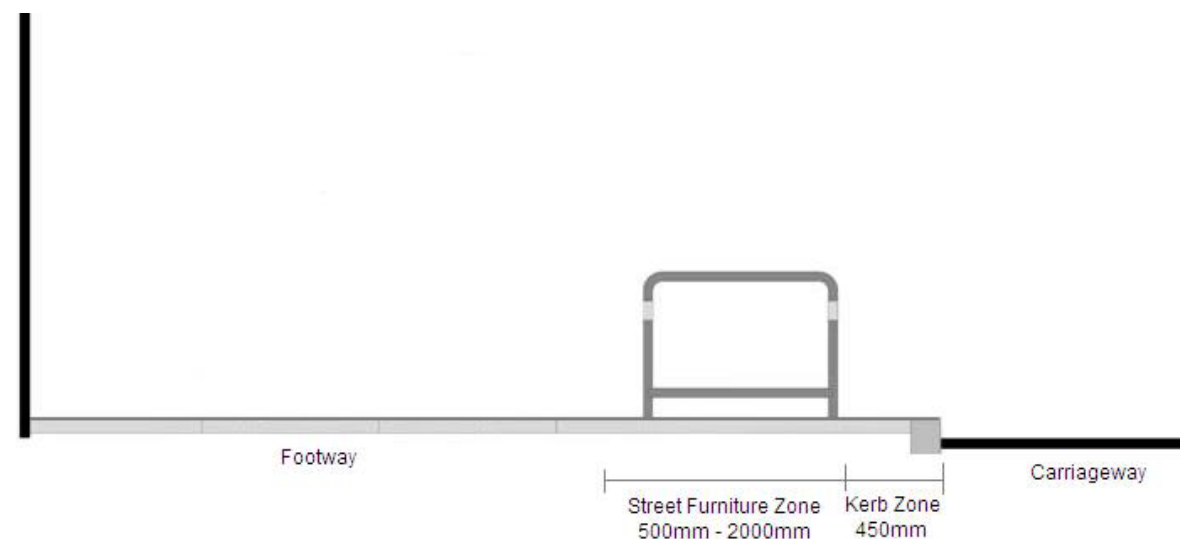

Figure 3.2: Street Furniture Zone





# 4. Planning Policy and Guidance

## 4.1 Introduction

In making a decision on whether to grant planning permission, Section 38(6) of the Planning and Compulsory Purchase Act 2004 (the 2004 Act) requires planning applications to be determined in accordance with policies of the statutory Development Plan, unless material considerations indicate otherwise.

This section first provides an assessment of the extent to which the proposal supports relevant policies within The London Plan (consolidated with alterations since 2011 (2015)), followed by the Camden Core Strategy (November 2010) and the Development Policies (November 2010), which together form the Local Plan. An assessment of the proposal against other relevant planning policy including the National Planning Policy Framework (NPPF) and guidance is provided thereafter.

At the national level the assessment of policy compliance focuses on sustainability, transport and design policies. At the local level the proposal is assessed against relevant policies within the Local Plan.

Camden Council is currently reviewing its main planning policies and is consulting on a draft 'Local Plan'. These policies currently carry no weight in the decisions of planning applications as they are too early in the process.

## 4.2 The Development Plan

### *The London Plan*

The London Plan is the overall strategic plan for London, and sets out a fully integrated economic, environmental, transport and social framework for the development of the capital over the next 20-25 years.

Strategic principles are fundamental to the overall London Plan. Policy 1.1 (Delivering the strategic vision and objectives for London) states that growth and change in London will be managed in order to achieve the Mayor's vision for London's sustainable development, ensuring all Londoners enjoy a good, and improving, quality of life sustainable into the future.

The cycle hire scheme is recognised as an initiative which supports London's visitor economy in a more sustainable approach (Policy 4.5 of the London Plan).



Policy 5.1 (Climate Change Mitigation) seeks a reduction in London's carbon dioxide emissions of 60% by 2025.

Delivery of an efficient and effective transport system is a key component of the London Plan. Policy 6.1 (Integrating Transport and Development) seeks to encourage integration of transport within new schemes and supports a shift to more sustainable modes of transport. It promotes a greater use of low carbon technology in order to reduce carbon dioxide and other contributors to global warming ensuring a minimal impact on the local environment. It requires Boroughs to support sustainable means of transport and reduce the need for travel by car (by imposing maximum car parking standards and minimum cycle parking standards). Table 6.1 'Indicative List of Transport Schemes' notes that the Central London Cycle Hire Scheme is to be expanded in area and/or additional bikes within central London to be completed by 2013-2020.

The Mayor will encourage a significant increase in cycling. Policy 6.9 (Cycling) states that the Mayor will identify, promote and implement a network of cycle routes across London, continue operate and improve the cycle hire scheme, and fund the transformation of outer London town centres into cycle friendly 'mini-Hollands'. This means that planning decisions should facilitate the Mayor's cycle hire scheme through provision of land and/or planning obligations where relevant, to ensure the provision of sufficient capacity. It also outlines that cycling facilities are to be integrated within new developments and that Local Development Frameworks should identify, promote, facilitate the Cycle Super Highways and identify and safeguard sites for new or expanded cycle docking stations to increase capacity of the Mayor's cycle hire scheme.

Policy 6.11 (Smoothing Traffic Flow and Tackling Congestion) outlines that a coordinated approach needs to be taken in order to smooth traffic flow and tackle congestion. It states that Development Plan Documents should improve the extent and quality of pedestrian and cycling routes, improve management of the road network and support a shift to walking and cycling to improve traffic congestion and reduce air pollution.

Policy 7.5 states that development should make the public realm comprehensible at a human scale. This means that public and private open spaces should contribute to the highest standards of comfort, security and ease of movement possible.

The London Plan seeks to encourage healthy lifestyles in order to reduce health inequalities within London. It outlines that transport (along with other developments) should incorporate health benefits.



The cycle hire scheme provides a sustainable mode of public transport which makes a significant contribution to improving London's transport system and reducing traffic congestion. It provides an active form of transport therefore promoting a healthier lifestyle.

**Camden Core Strategy**

The Camden Core Strategy sets out the key elements of the Council's planning vision and strategy for the borough. Camden's Core Strategy was adopted, alongside the Development Policies, at the Full Council meeting on 8 November 2010.

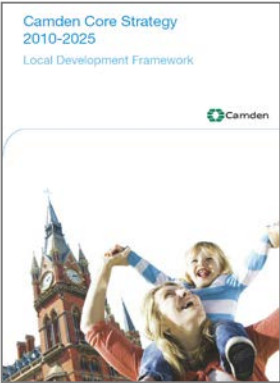

The Core Strategy outlines a number of key issues for the future development of Camden. Those of particular relevance are:

- The quality of the environment;
- climate change and sustainability; and
- improving transport.

Policy CS2 focuses development in Camden to 2025 in the growth areas of King's Cross, Euston and the Tottenham Court Road, Holborn and West Hampstead Interchange, whilst Policy CS3 promotes appropriate development in other highly accessible areas. Policy CS8 aims to promote a successful and inclusive Camden economy. Schemes to encourage cycling is linked to the Council's strategy to improve Central London.

Core Strategy CS11 (Promoting sustainable and efficient travel) seeks the continual improvement of facilities for cyclists, including increasing the availability of cycle parking, helping to deliver the London Cycle Hire Scheme, and enhancing cycle links. CS14 (Promoting high quality places and conserving our heritage) seeks to ensure that Camden's places are attractive, safe and easy to use by requiring development of the highest standard of design that respects local context and character. CS14 also seeks to preserve and enhance Camden's rich and diverse heritage (including conservation areas, listed buildings and historic parks and gardens).

Camden is the lead authority in the Clear Zones Partnership with the City of London and City of Westminster. This aims to reduce congestion, air and noise pollution and improve the urban realm through partnership working, sustainable transport measures and the use of innovative technologies.

The Core Strategy makes specific reference to the London Cycle Hire Scheme. London Borough of Camden state that they will seek to ensure that the scheme is extended to key destinations across the borough, including their town centres.

The Cycle Hire Scheme will promote cycling as an alternative mode of travel for short journeys.

The docking station has adopted principles of high quality design and consideration has been given to the need to preserve and enhance the built heritage in selecting a suitable site. For these reasons, the proposal is considered to comply with the Core Strategy.

As the site is within the Bloomsbury Conservation Area, the Bloomsbury Conservation Area Appraisal and Management Strategy (2011) has been referred to.

**Camden Development Policies**

Camden Development Policies 2010-2025 seeks the provision of sustainable travel options in order to reduce the environmental impact of travel, to support future growth, to relieve pressure on Camden's existing transport network, and to provide alternatives to the private car (Policy DP17). Minimum standards for cycle parking are provided in Policy DP18.

Policy DP19 states that where parking is created or reallocated, Camden will encourage the allocation of cycle hire and parking. The Camden Development Policies document also states that contributions towards wider cycle initiatives may also be sought from new developments, as cycle hire and cycle stations are integral elements of the Council's approach to promoting cycling.

Camden has inherited a rich architectural heritage with many special places and buildings from many different eras in the area's history. Policy DP25 'Conserving Camden's Heritage' seeks to maintain Camden's Conservation areas and listed buildings.

**Supplementary Planning Guidance**

The Camden Planning Guidance (2011) provides additional advice and guidance for development proposals. The guidance seeks to:

- Ensure that the Cycle Hire Scheme is extended to key destinations. Where appropriate, developments could be required to provide a financial contribution or include a docking station within the development if suitable (Paragraph 9.9 of CPG 7 Transport);
- Provide for connectivity to, from, around, and through sites for people using all modes of transport, including pedestrians, cyclists etc. (Paragraph 2.9 of CPG 1 Design);
- Respect the built form, character, history, archaeology and nature of existing buildings on the site and other buildings immediately adjacent and in the surrounding area. (Paragraph 2.9 of CPG 1 Design);
- Respect and be sensitive to natural and physical features, both on and off the site. (Paragraph 2.9 of CPG 1 Design);
- Ensure that street furniture does not obstruct pedestrian views or movement or be positioned to encourage anti social behaviour (Paragraph 9.23 of CPG 1 Design).





## Streetscape Design Guidance

Camden's *Streetscape Design Manual* (2005) seeks to raise the standard of street works throughout the borough. It sets out six key design principles respecting and enhancing the local streetscape;

- using a simplified palette of quality materials;
- providing a clutter-free environment on our streets;
- enabling equal and inclusive access for all road users;
- considered, yet innovative complementary design; and
- making the street environment safer.

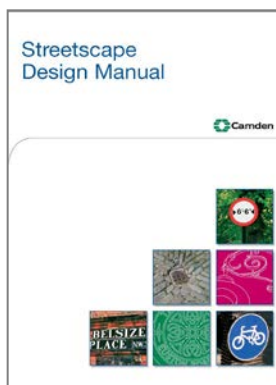

More specifically, the Streetscape Manual provides detailed design guidance for cycle parking. The Borough supports the provision of cycle parking in order to actively encourage cycle use. The Manual notes that cycle parking should be installed wherever demand is evident and where space allows. The guidance is relevant to the proposal in terms of influencing the design, layout and location of the docking station.

These proposed design of the docking station and the arrangement of the docking points and terminal within the site reflects these design guidelines.

## 4.3 Other Planning Documents

### ***National Policy Documents***

The National Planning Policy Framework (NPPF) was published on the 27 March 2012 and sets out the Government's planning policies for England. At the heart of the NPPF is a presumption in favour of Sustainable Development. Paragraph 9 states that "pursuing sustainable development involves seeking positive improvements in the quality of the built, natural and historic environment, as well as in people's quality of life". This includes improving the conditions in which people, live, work, travel and take leisure.



The NPPF includes 12 principles for delivering sustainable development. Principle 4 'Promoting sustainable transport' seeks to highlight the importance of sustainable transport modes, ensuring people have a choice about how they travel. Paragraph 30 states that solutions that support reductions in greenhouse gas emissions and reduce congestion should be encouraged.

Principle 7 'Requiring good design' highlights the importance of design in the built environment. Paragraph 58 outlines that planning decisions should support local transport networks and ensure that developments create safe and accessible environments. Paragraph 63 adds that, when determining applications, "great weight should be given to outstanding or innovative designs".

Principle 8 'Promoting healthy communities' highlights the important role the planning system can have in facilitating social interaction and creating healthy, inclusive communities. It identifies that planning decisions should aim to promote safe and accessible environments, and encourage the active and continual use of public areas.

Principle 10 'Meeting the challenge of climate change, flooding and coastal change' outlines the importance of the planning system in helping to secure radical reductions in greenhouse gas emissions, providing resilience to the impacts of climate change, and supporting the delivery of renewable and low carbon energy and infrastructure.

Paragraph 35 states that developments should be located and designed where practical to give priority to cycle movements and have access to high quality public transport facilities.

The NPPF also states that planning decisions should aim to achieve places which promote safe and accessible environments and developments, which contain clear and legible pedestrian routes and high quality public space which encourage the active and continual use of public areas.

The Cycle Hire Scheme provides a sustainable mode of transport which is considered to support the sustainable development principles highlighted in the NPPF, by providing a green infrastructure across London. The Scheme helps to encourage healthy and sustainable communities and its design has been carefully considered to be innovative and compatible with London streetscapes.

### ***The Mayor's Vision for Cycling in London (2013)***

*The Mayor's Vision for Cycling* published in March 2013 sets out the Mayor's plans for substantial change in order to treat cycling as an integral part of the transport network.

The key outcomes of the plans will be a Tube network for the bike, safer streets, more people travelling by bike and better places for everyone.



## The Mayor's Transport Strategy

The Mayor's Transport Strategy published in May 2010 sets policies to improve transport within Greater London. The strategy sets out the Mayor's vision, which requires a transport system with enhanced capacity and connectivity that is efficient and integrated; encourages mode shift to cycling, walking and public transport; is accessible and fair to users; offers value for money; contributes to improving quality of life and the environment; and offers improved opportunities for all Londoners.

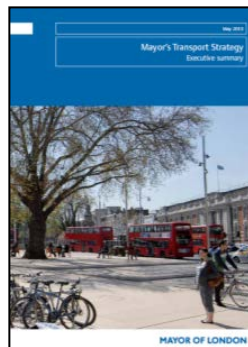

Proposals in chapter 5.13 set out to encourage more cycling. Proposal 53 seeks to raise the profile of cycling, and proposal 54 specifically seeks to deliver the Cycle Hire Scheme, along with other cycling facilities. The strategy also recognises the health benefits of cycling in Policy 17, which seeks to promote healthy travel options.

Proposal 83 seeks to use the principles of 'better streets' to improve town centres, in particular: removing clutter and improving the layout and design of streets; enhancing and protecting the built and historic environment; increasing the permeability of streets; and creating clear and easily understandable routes and spaces to make it easier for cyclists, pedestrians and disabled people to get about.

## The Mayor's Climate Change Mitigation and Energy Strategy

Delivering London's energy future was adopted in October 2011.

The Strategy sets out a strategic approach to reduce carbon emissions from a range of sources, including London's transport. Action 10.5 under Policy 10 promotes the development of the London Cycle Hire Scheme as part of a shift to more carbon efficient modes of transport.

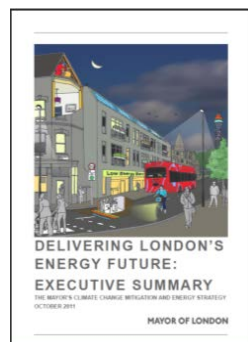

## The Mayor's Air Quality Strategy

Clearing the Air was published in December 2010 following public consultation. It sets out the Mayor's plans to improve air quality in the Capital, including the reduction of air pollution from London's transport.

Cycle Hire is included in the Strategy as one way to promote a shift to cleaner forms of transport (Policy 1: encouraging smarter choices and sustainable travel). It also notes that the eastwards expansion of the scheme, combined with public transport improvements, will help to achieve behavioural change away from the car to more sustainable modes.



## The London Health Inequalities Strategy

### Sustainable Future for Cycling

The Mayor published his first ever Health Inequalities Strategy in April 2010, along with an accompanying 'action plan', *First Steps to Delivery*. The cycle hire scheme is supported by objective 5 (Healthy places), which states:

*"Efficient and affordable transport systems can also help to tackle health inequalities. The Mayor's Transport Strategy emphasises the need to reduce congestion, reduce transport related carbon emissions, improve the reach and reliability of London's public transport system and increase the number of people walking and cycling which will be greatly helped by the introduction of the cycle hire scheme".*

The Scheme can help to reduce health inequalities by encouraging active travel and providing a low-cost form of transport to access employment and services, and therefore supports this strategy. The expansion of the Scheme will bring these benefits to a wider group of people.

### Cycling Revolution London

Within *Cycling Revolution London* (May 2010) the Mayor states that cycling has an important role to play in the future of the Capital and affirms that it is the "single most important tool for making London the best big city in the world". The Cycle Hire Scheme is the centrepiece of the cycling programme to make London a genuine cycle-friendly city.

### Sustainable Future for Cycling

*Sustainable Future for Cycling* published in January 2008 sets out the Government's planning policy direction regarding cycling. It recognises the important contribution of cycling as a sustainable form of transport and how cycling contributes to climate change; health, security and safety; quality of life; and equality of opportunity.

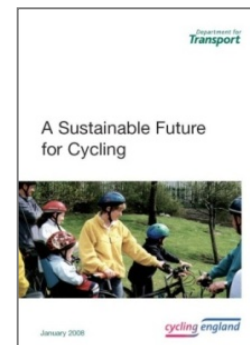
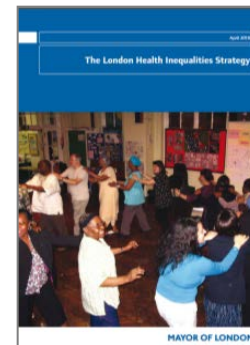



## 4.4 Streetscape Design Guidance

### ***Streetscape Guidance: A guide to better London streets***

*Streetscape Guidance: A guide to better London streets (2009)* prepared by TfL gives guidance on streetscape issues and shows how the Mayor's Better Streets objectives may be achieved. The document advises on key design principles including:



- consistency and clarity;
- integration and co-ordination;
- design for people;
- reduction of crime and disorder;
- function and safety;
- materials and maintenance; and
- recognition of local context and distinctiveness (including local heritage and its statutory and local designations).

The Scheme delivers a high quality design which is in line with these principles.

### ***The London Cycling Design Standards***

*The London Cycling Design Standards (2014)*, prepared by TfL, sets out design guidance and indicative standards for all cycle schemes in London. Of particular relevance is Chapter 8 which notes the increasingly important role of cycle hire in facilitating choice in access to and onward journeys from a transport interchange. Chapter 8 also states that cycle parking should be an integral part of streetscape design and explains how cycle stand design and location can complement the existing streetscape.



# 5. The Application

## 5.1 Site Characteristics

### 5.1.1 Location

The site is located on the carriageway on Coram Street near to the junction with Woburn Place in the London Borough of Camden (Figures 5.1 and 5.2).

Coram Street is a two way street with footways on both sides. It carries a moderate level of vehicular traffic and has a moderate footfall. The surrounding area is made up of a mix of residential and commercial. There is a car park opposite the proposed site, and there are some hotels and restaurants on Woburn Place.

Russell Square Underground Station is located south-east of the site.

The site falls within the Bloomsbury Conservation Area and the Central London Area (Clear Zone Region). There are no listed buildings visible from the site. The site is not located within a flood zone.

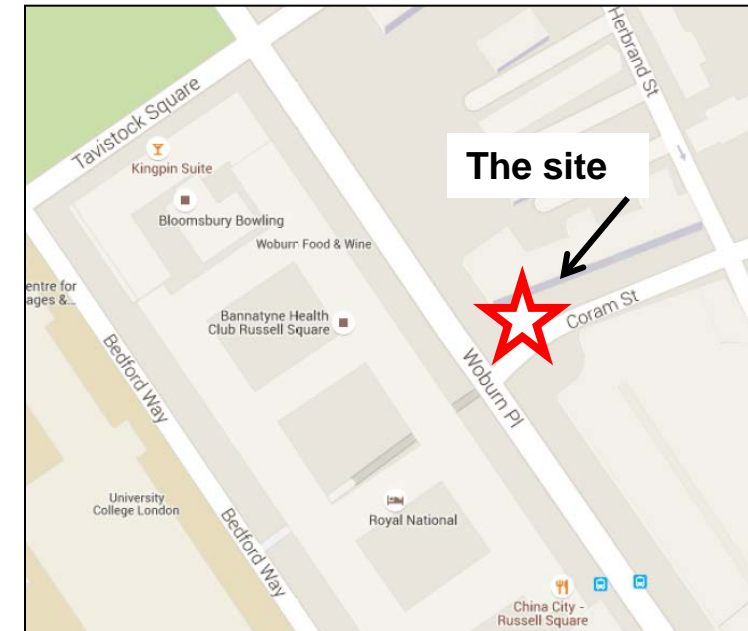

Figure 5.1: Map showing general location of site



Figure 5.2: Location Plan





**5.1.2 Transport Links**

The site is located approximately 0.1 miles (3 minute walk) from Russell Square Underground Station.

The closest bus stops are located on Woburn Place. Stops J and H are served by bus routes 59, 68, 91, 168 and N91.

As shown in Figure 5.3, the site is located in close proximity to both cycle superhighways (in blue) and cycle routes (in red).

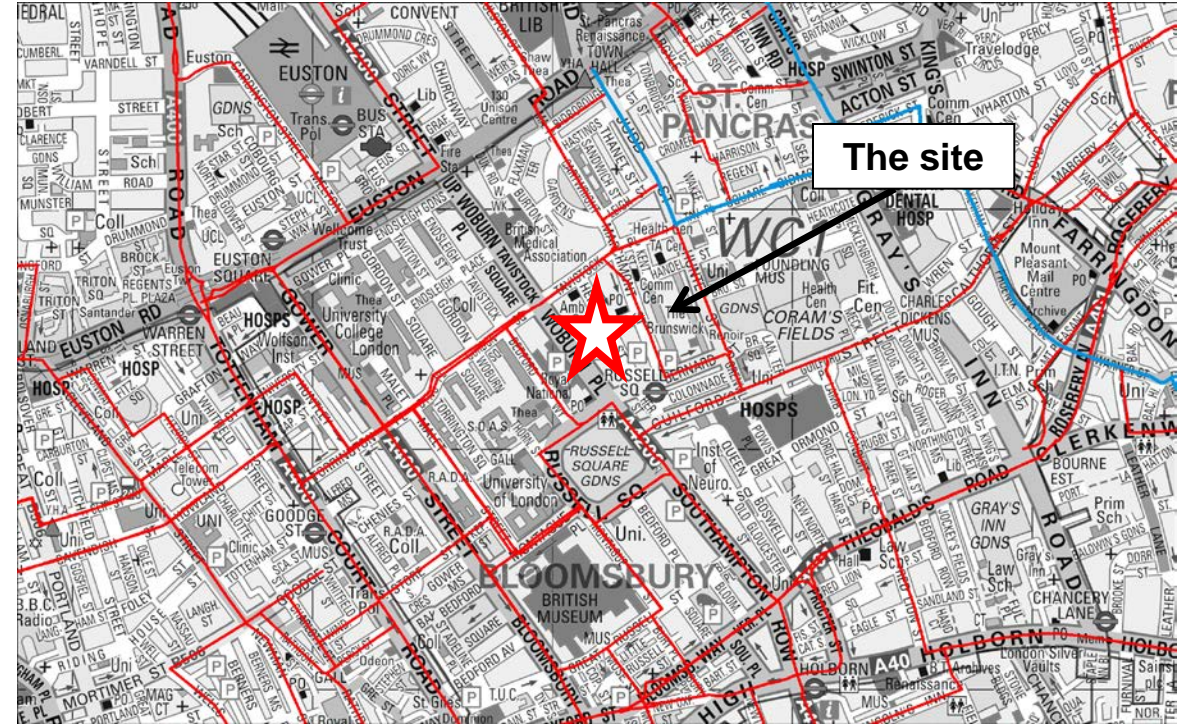

Figure 5.3: London Cycle Network, showing general location of site

**5.1.3 Site Description**

The proposed site is located on the northern side of the carriageway on Coram Street near to the junction with Woburn Place. The immediate area is a mixture of residential (namely Witley Court and Russell Court) and commercial (on the ground floor of Witley Court) and it is opposite a car park. There are also hotels located nearby on Woburn Place. Outside the Royal National Hotel on Woburn Place there is an area on the carriageway which is used as a stopping point for Big Bus London.

The proposed site is existing pay & display parking bays and a disabled bay. There are a number of service covers in the area of the site and some small trees on the footway.

Lamp posts, a signpost and a ticket machine are on the footway. There are some trees adjacent to the site on the footway.



Figure 5.4: View of site facing north



## 5.2 The Proposal

The proposal is to install a docking station within the yellow shaded area on Figure 5.5.

The docking station will have a maximum length of 24.5 metres, plus build out on either side, and will not exceed a maximum width of 2.0 metres (Figure 5.5).

The docking station will accommodate a maximum of 30 docking points with the docking points laid out in a single linear row as shown in Figure 5.6. The terminal will be positioned towards the eastern end of the site. The docking station design will accord with the criteria outlined in Section 1.3.

A signpost and parking ticket machine are on the footway which will need to be relocated out of the cycle hire site and adjacent to the remaining pay and display bays.

The site will take the place of 12 metres of pay and display bays (2 pay bays). The disabled bay will be relocated further along the road at the end of the cycle hire site where the existing single yellow line is.

A kerb island buildout will be constructed at both ends of the site to improve safety for the users. A 300mm gap will be left between the kerb and the island to assist drainage and a reflective bollard will be on the western island.

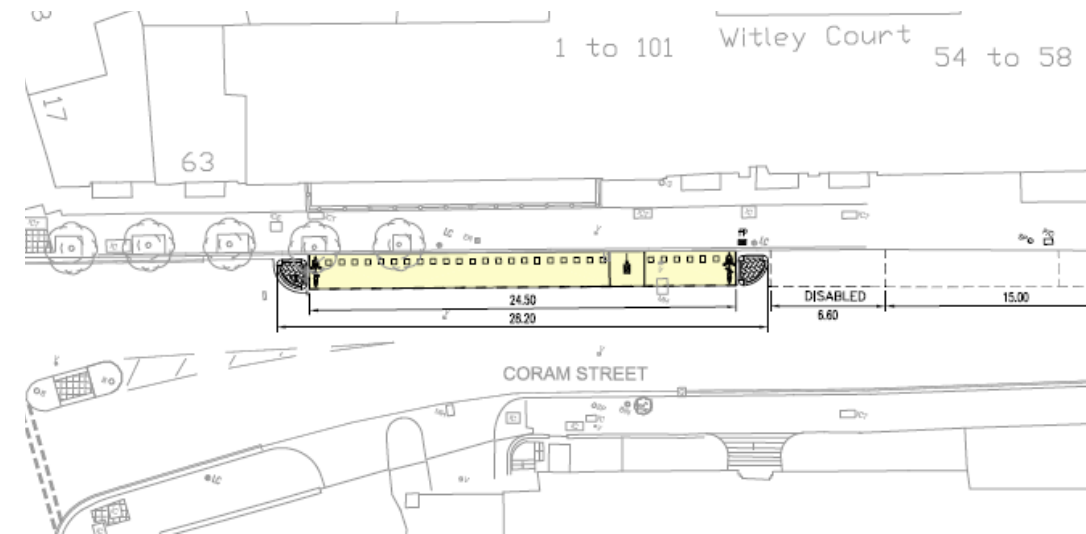

Figure 5.5: Proposed docking station arrangement extract

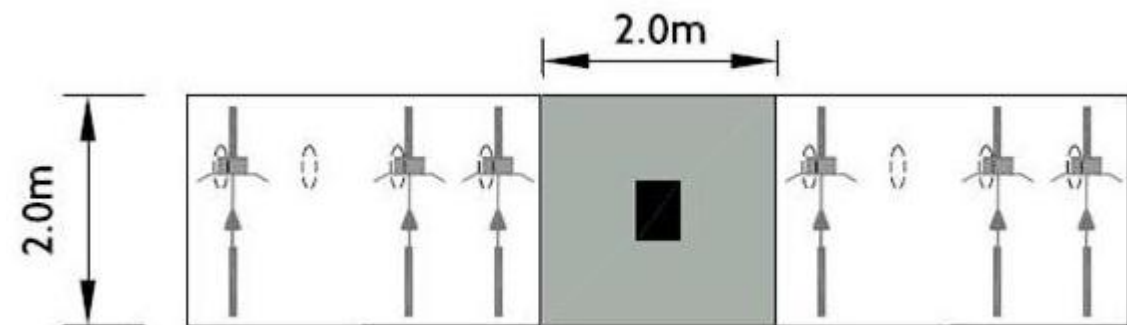

Figure 5.6: Indicative docking station layout extract





## 5.3 Key Issues

### 5.3.1 Traffic, Access and Parking

The location of the site provides access to public transport and to the London Cycle Network. It is within a short distance of Russell Square Underground Station and bus services. This will ensure easy access to the docking station for a wide range of users.

The docking station would be located on the carriageway on the northern side of Coram Street near to the junction with Woburn Place. The proposal does result in the loss of two pay and display bays, and the relocation of the disabled bay further along the road at the end of the cycle hire site where the existing single yellow line is. It is evident that there is sufficient alternative parking provision available in the wider vicinity of the site, and furthermore, the benefits from the promotion of cycling as a sustainable alternative to the car (in accordance with national and local planning policy guidance) are considered to outweigh the proposed loss of parking spaces at this location.

Traffic flow will not be impacted as the area of the carriageway is wide enough to ensure that movement continues to be direct, permeable, safe and legible. A kerb island is also going to be constructed in order to improve safety. The docking points are also of a sufficiently low height to ensure that it will not impede vehicle sightlines.

Sufficient circulation area is provided around the terminal to avoid congestion, and a Membership key reader will be installed at each docking point, enabling users to hire bicycles without having to queue at the terminal and thereby minimising the time required for users to be at the cycle station.

The docking station also includes a map on the terminal which will assist in the provision of way-finding of the local area and the location of other docking stations.

Overall, this is an ideal site for providing a docking station as clear travel paths can be maintained and pedestrian congestion is avoided.

### 5.3.2 Townscape, Heritage and Amenity

#### Existing Situation

The site is located within the Bloomsbury Conservation Area.

The immediate environment is dominated by the flank elevation of the Royal National Hotel on Woburn Place, the car park opposite the site, and the two residential buildings; Russell Court and Witley Court. The Bloomsbury Conservation Area Appraisal and Management Strategy recognises Russell Court and Witley Court as a positive contributors to the area. The Strategy also states that “the most distinct feature is the concave curve of the entrance to the integral car park, addressing the corner of Coram Street”.

The row of trees on the adjacent footway provides visual amenity for the area.

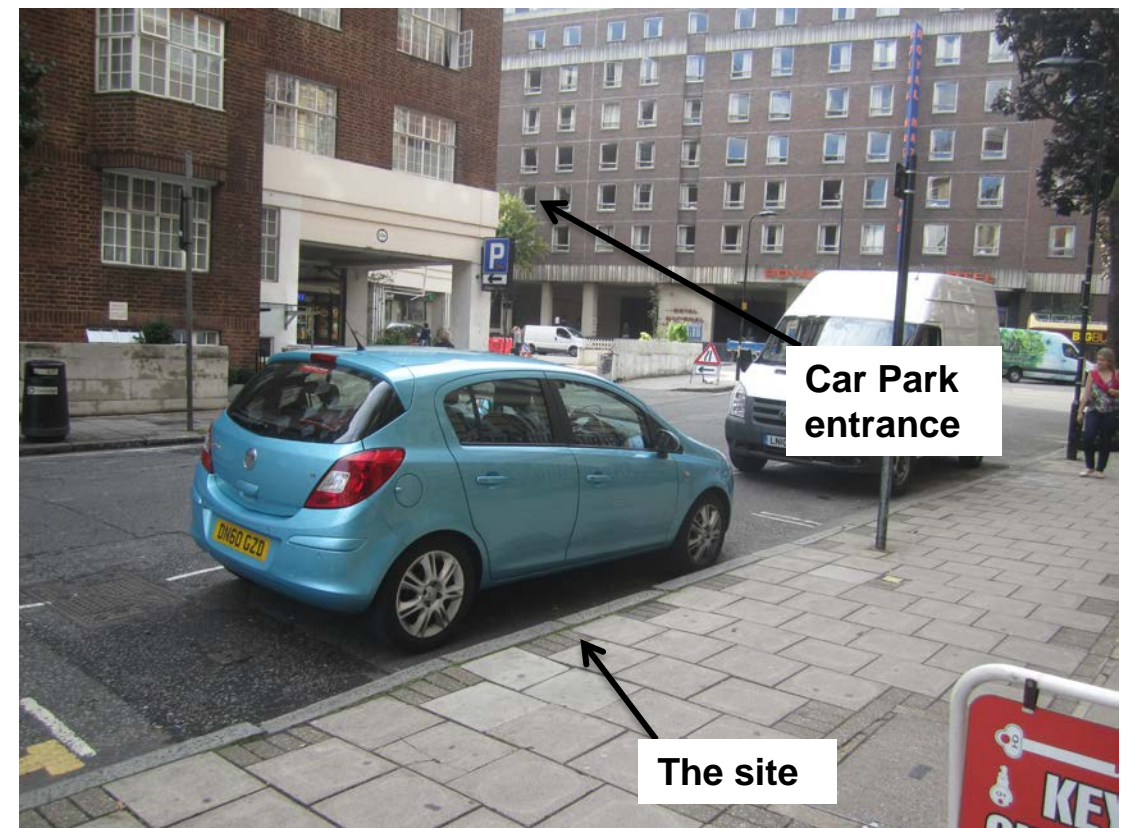

Figure 5.7: View of the site





## Proposed Works

In selection of the site consideration has been given to the existing function of the carriageway and the context of the surrounding buildings. The proposed docking station will be viewed in the setting of the carriageway and will strengthen transport and public function of this space (Figures 5.8 and 5.9).

Due to its location on a carriageway, the docking station would tend to be viewed in the context of the carriageway and its street furniture rather than the surrounding built form. The location does require the loss of two existing parking spaces, however, the disabled parking bay will be relocated at the end of the docking station site where the existing single yellow line is.

The docking points will have a maximum height of 0.8 metres and the width between the centre of each docked bicycle will be 0.75 metres. This will allow a sense of visual permeability and will limit the presence of the docking station within the street scene.

The application site is located in a conservation area, however, there are no listed buildings within the immediate vicinity of the site. It is considered that the docking station would sit well within the street and would not visually clutter the streetscene. Given the modest size and scale of the docking station and its separation distance from the adjacent buildings, it is considered that the proposed docking station would not harm the setting of the conservation area, particularly as the carriageway site is currently being used for parking.

The docking station has been designed to enable quick and quiet use of both terminal and docking points by users, as described in Section 2.3. The use of the docking station will have very little impact on disturbing users of the area, as the noise levels and amenity levels are considered to be similar to that which they experience currently through the use of the site as parking spaces.

The materials of the docking station will complement other street furniture within the context of the site. The size and the dark blue colour of the terminal and the layout and size of the docking points have been carefully chosen to ensure the docking station integrates with the surrounding environment. The colour also complements the existing hues of London signage, bollards and railings.

Given the size, scale and location of the docking station, it is considered that it will integrate well with the buildings in the immediate vicinity.

As such, the docking station will be compatible with the character and appearance of the surrounding buildings and street features.



Figure 5.8: View of the site looking west.



Figure 5.9: View of the site looking north-east.



### 5.3.3 Trees

The proposed docking station will be located within the Root Protection Area (RPA) of two Norway maple trees (T1 and T2) situated on the northern footway of Coram Street. The trees are of a young age and are in good physiological condition.

A tree survey has been carried out and forms part of this application (BS5837:2012 Tree Survey Report, Incorporating Arboricultural Implications Assessment and Method Statement).

Assuming that the measures outlined in the Arboricultural Method Statement are adopted, it is considered that the proposed docking station would not detrimentally impact on trees within the vicinity of the development.

### 5.4 Application Summary

The application will fully support National and Local Planning Policies and Streetscape Design Guidance. In addition to the wider benefits which are outlined in Section 2 the Cycle Hire Scheme will:

- meet the Borough's site selection criteria (outlined in Section 1.3);
- ensure the delivery of the Cycle Hire Scheme network is at the required density;
- provide a well-considered design that is compatible with the activities and functions of the Central Activity Zone;
- provide a well-considered design that maintains the character of the Bloomsbury Conservation Area;
- provide a well-considered design that preserves the amenity and value of the nearby trees;
- provide a well-considered design that is compatible with the surrounding area and preserves residential amenity;
- provide a high quality design which ensures that the development is compatible with the function of the street; and
- not affect the safety of highway users or affect the flow of pedestrian or vehicular traffic in the area.

