

ITEM 6 FLAXMAN COURT

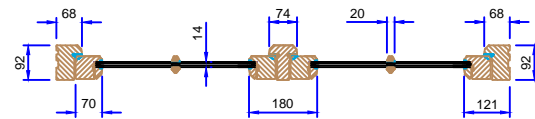

ITEM 1 FLAXMAN COURT

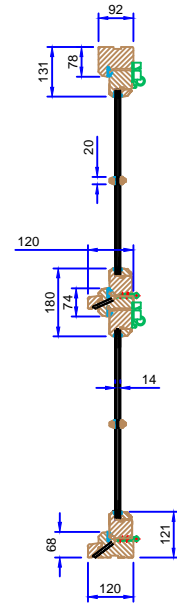
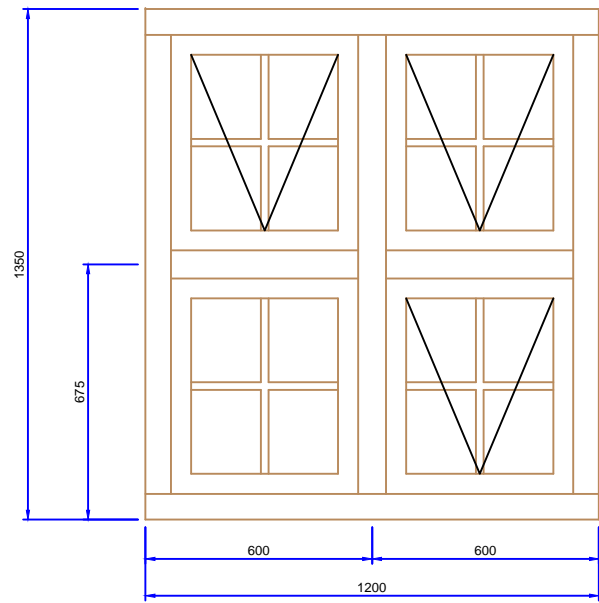
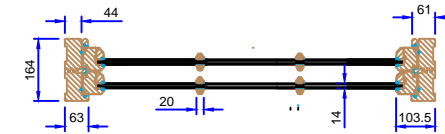
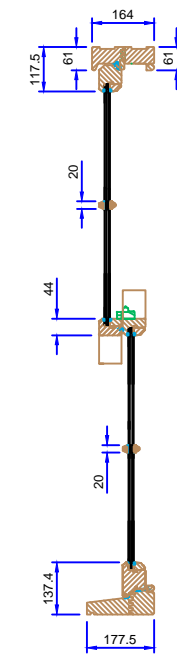
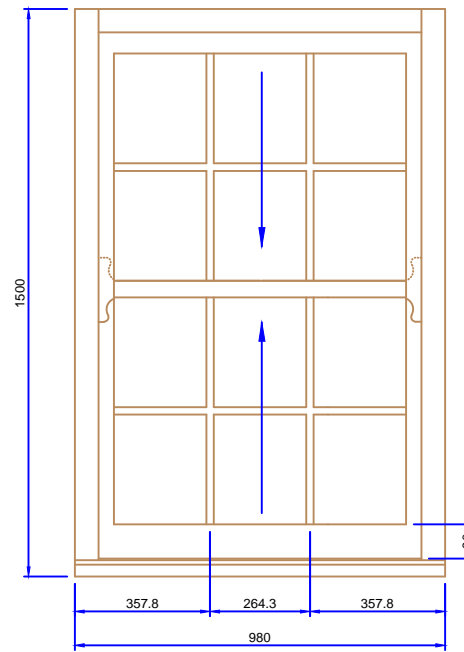

ITEM 3 FLAXMAN COURT

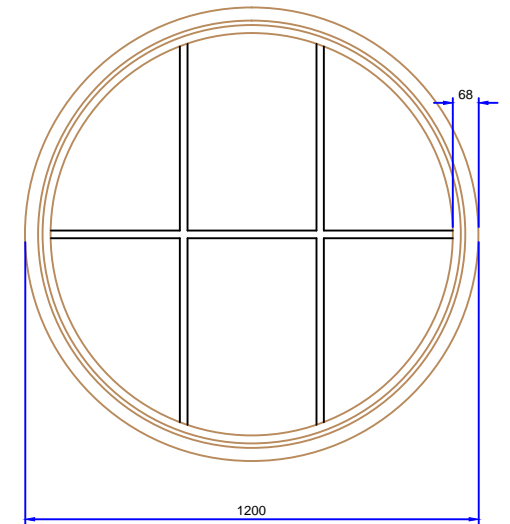

ITEM 4 FLAXMAN COURT

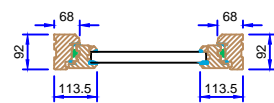
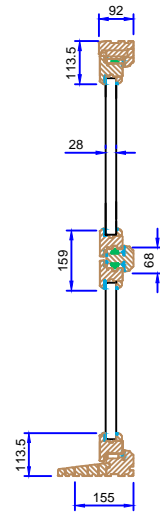
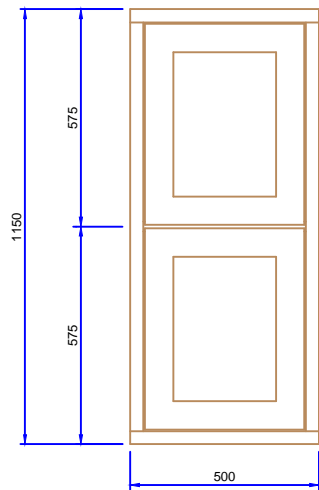

ITEM 8 FLAXMAN COURT

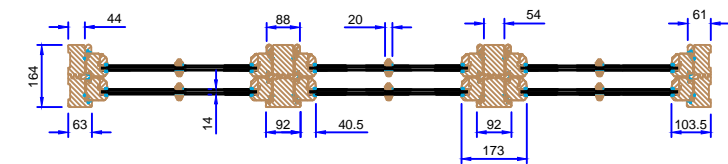
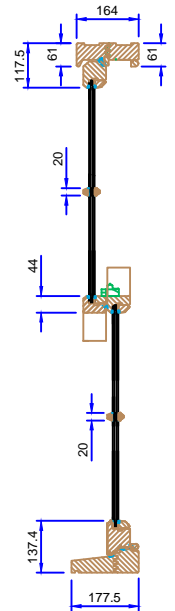
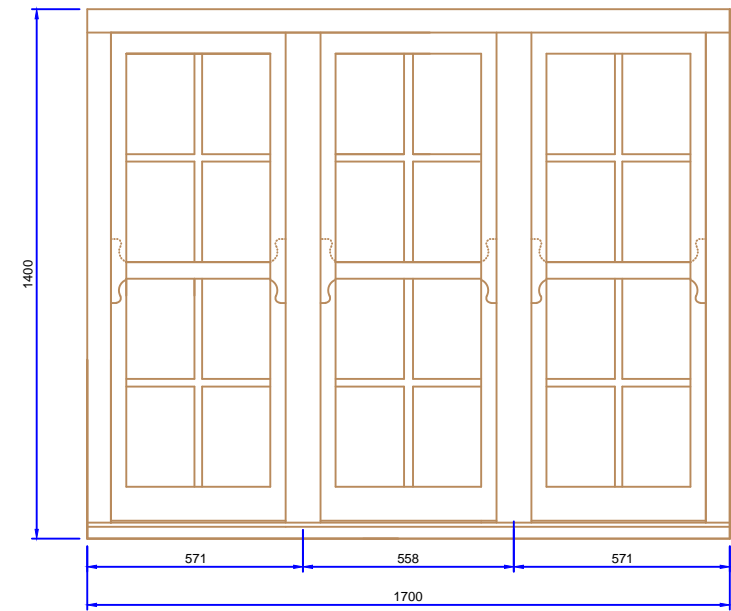
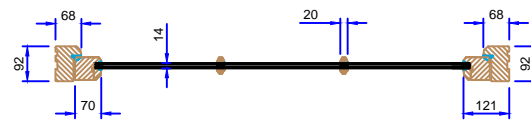
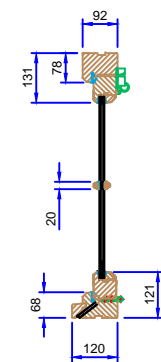
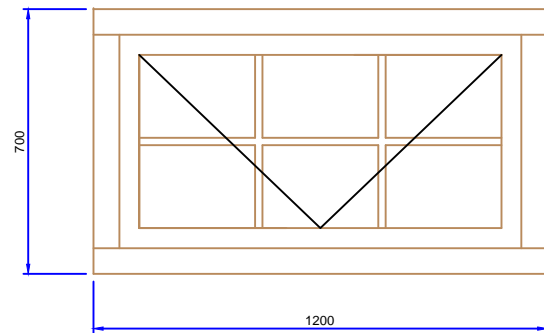

B	HORNS ADDED TO BTM SASH	26.08.15	PH
A	MULLION DESIGN V/S ADDED	21.08.15	PH
REV	CHANGE	DATE	BY



Arden Windows Ltd,  
Arden House,  
Sparkbrook Street, Coventry CV1 5ST.  
Tel. 02476 623423  
Fax. 02476 237317  
www.ardenwindows.net

DETAIL

ELEVATION & SECTIONAL  
DRAWING DESIGNS FOR  
LAKEHOUSE CONTRACTS  
REF : 1-86 FLAXMAN COURT.

Drawn By

PH

Approved By

Dated

18.08.2015

DRG No  
PH921

SHEET 01

Issue B

SCALE A3 - 1:20  
A4 - NTS