



34 -38

Eversholt

Street,

London,

NW1 1DA

Daylight, Sunlight &
Overshadowing
Report

July 2015

Ref: 15-1632

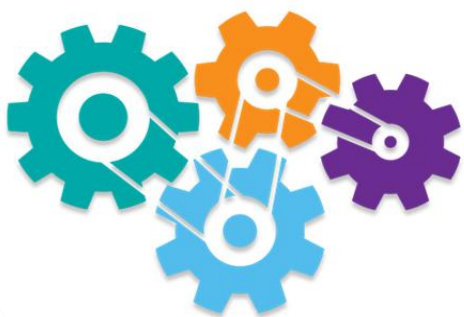

- 1. EXECUTIVE SUMMARY 6
- 2. INTRODUCTION 7
- 3. PLANNING POLICY 8
- 4. GUIDANCE DOCUMENT..... 8
 - 4.1. Building Research Establishment (BRE) report (BRE 209): "Site layout planning for daylight and sunlight: A guide to good practice" Second Edition (2011)..... 8
- 5. ASSESSMENT METHODOLOGY..... 9
 - 5.1. General 9
 - 5.2. BRE Digest 209: "Site layout planning for daylight and sunlight" 10
 - 5.2.1. Daylight..... 10
 - 5.2.2. Sunlight..... 11
 - 5.2.3. Overshadowing to gardens and open spaces 11
- 6. BRE DIGEST 209: SIGNIFICANT CRITERIA 12
 - 6.1. Daylight..... 12
 - 6.2. Sunlight..... 12
 - 6.3. Overshadowing to gardens and open spaces 12
 - 6.4. Criteria for assessing daylight, sunlight and overshadowing effects 13
 - Table 1: Criteria for assessing daylight, sunlight and overshadowing effects.....13
- 7. ASSESSMENT 14
 - 7.1. BS 8206-2: 1992 14
 - 7.2. Daylight..... 14
 - Table 2: Daylight results15
 - 7.3. Sunlight..... 16
 - Table 3: Sunlight results16
 - 7.4. Overshadowing 18
 - Table 4: Overshadowing results18
- 8. CONCLUSION 19
 - 8.1. Daylight..... 19
 - 8.2. Sunlight..... 19



8.3. Overshadowing 19

9. APPENDIX..... 20

9.1. Sunrise and sunset time 20

9.2. Sun path..... 20

9.3. Suntrace 21

9.4. Site plan and location 22

9.4.1. Existing site layout.....22

9.4.2. Proposed site layout.....23

9.5. Model images..... 26

9.6. Daylight results..... 27

9.7. Sunlight results..... 44

9.8. Overshadowing results and pictures (21st March)..... 58



Quality Standards Control

The signatories below verify that this document has been prepared in accordance with our quality control requirements. These procedures do not affect the content and views expressed by the originator.

This document must only be treated as a draft unless it has been signed by the originators and approved by a director.

DATE	PRODUCED BY	CHECKED BY	APPROVED BY
09/07/2015	FC	FC	AWK

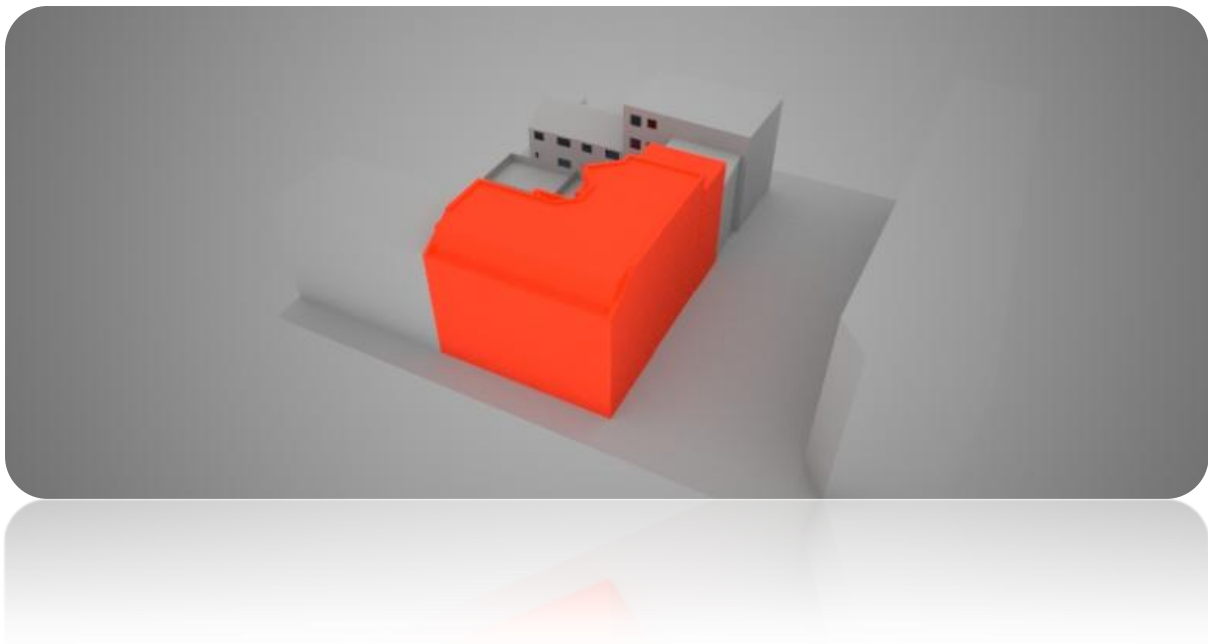

Revision	
Date	
Prepared by	
Checked by	
Authorised by	

Limitations

Syntegra Consulting Ltd (“SC”) has prepared this report for the sole use of **Transeur Properties Ltd (“Client”)** in accordance with the agreement under which our services were performed. No other warranty, expressed or implied, is made as to the professional advice included in this report or any other services provided by SC.

The conclusions and recommendations contained in this report are based upon information provided by others and upon the assumption that all relevant information has been provided by those parties from whom it has been requested and that such information is accurate. Information obtained by SC has not been independently verified by SC, unless otherwise stated in the report.

The methodology adopted and the sources of information used by SC in providing its services are outlined in this report. The work described in this report was undertaken in **July 2015** and is based on the conditions encountered and the information available during the said period of time. The scope of this report and the services are accordingly factually limited by these circumstances.

Where assessments of works or costs identified in this report are made, such assessments are based upon the information available at the time and where appropriate are subject to further investigations or information which may become available.

SC disclaim any undertaking or obligation to advise any person of any change in any matter affecting the report, which may come or be brought to SC’s attention after the date of the report.

Certain statements made in the report that are not historical facts may constitute estimates, projections or other forward-looking statements and even though they are based on reasonable assumptions as of the date of the report, such forward-looking statements by their nature involve risks and uncertainties that could cause actual results to differ materially from the results predicted. SC specifically does not guarantee or warrant any estimate or projections contained in this report.

Costs may vary outside the ranges quoted. Whilst cost estimates are provided for individual issues in this report these are based upon information at the time which can be incomplete. Cost estimates for such issues may therefore vary from those provided. Where costs are supplied, these estimates should be considered in aggregate only. No reliance should be made in relation to any division of aggregate costs, including in relation to any issue, site or other subdivision.

No allowance has been made for changes in prices or exchange rates or changes in any other conditions which may result in price fluctuations in the future. Where assessments of works or costs necessary to achieve compliance have been made, these are based upon measures which, in SC’s experience, could normally be negotiated with the relevant authorities under present legislation and enforcement practice, assuming a pro-active and reasonable approach by site management.

Forecast cost estimates do not include such costs associated with any negotiations, appeals or other non-technical actions associated with the agreement on measures to meet the requirements of the authorities, nor are potential business loss and interruption costs considered that may be incurred as part of any technical measures.

Copyright

© This report is the copyright of SC. Any unauthorised reproduction or usage by any person other than the addressee is strictly prohibited.

1. Executive summary

This report demonstrates that the levels of daylight at the surrounding buildings Euston House, Ian Hamilton House and 10-12 Doric Way are adequate.

BRE criteria met:

This report demonstrates that the levels of sunlight at the surrounding buildings Euston House, Ian Hamilton House and 10-12 Doric Way are adequate.

- ✓ **There will be however some impact on winter sunlight in some cases (4 windows: S6-S9-S10-S13). This however, is inevitable due to the fact that winter sunlight is received from lower angles of altitude measure vertically from the horizontal. Furthermore, it should be noted that the existing winter sunlight values are already low and it is questionable as to whether any occupier would notice such a slight change in WSPH. Overall, we believe that the impact is unlikely to be noticeable and the impact is compensated by the levels of annual sunlight hours (APSH). Indeed, the criteria set by BRE is 25% APSH while on the impacted windows the APSH are ranging from 37% to 44% which surpass the BRE criteria.**

BRE criteria met:

This report demonstrates that the existing amenity area/garden/open spaces located at 10-12 Doric Way and 40 Eversholt Street will not be adversely impacted by the proposed development.

- ✓ **The BRE criteria require at least 2 hours of direct sunlight on 21st March on 50% of the area or more. However, as it can be seen in more detail in the Appendix section 9.8, Amenity 1 and 3 do not meet the BRE criteria in the existing condition. Indeed, these 2 amenities barely receive any direct sunlight. As shown above, in existing conditions Amenity 1 receives direct sunlight on 2% of its area on average, 0.18% for amenity 2. Overall, we believe that the impact is unlikely to be noticeable by the occupants and we consider the results acceptable.**

BRE criteria met:

On balance, it can be concluded that the surrounding buildings at Euston House, Ian Hamilton House and 10-12 Doric Way will not be adversely impacted by the proposed development.

 **The proposed scheme is considered acceptable.**

2. Introduction

This report has been prepared to support the planning application for the proposed development at 34-38 Eversholt Street, London NW1 1DA. The proposed development consists of the development an additional floor on top of existing building at 34-38 Eversholt Street. The report assesses the daylight, sunlight and overshadowing effect of the proposed development on the surrounding buildings and specifically focuses on the windows of the residential buildings at Euston House, Ian Hamilton House and 10-12 Doric Way. The assessment is undertaken in accordance with **"BRE 209 Digest: Site Layout Planning for Daylight and Sunlight – A Guide to Good Practice"**.

The existing & proposed drawings (in AutoCAD format) of the project were provided by **SCP Architects** on the **01st July 2015** and have been used in preparing this report.

The study has been undertaken by constructing a 3D IES model of the existing and proposed site and surrounding buildings in order to analyse the daylight, sunlight and overshadowing impact of the new development on the affected buildings. All images used in this report are technical 3D models created using 2D AutoCAD Drawings (floor plans, sections and elevations) and not 3D visualisation images.

3. Planning policy

Where the proposed development has the potential to negatively impact the existing levels of daylight or sunlight on neighbouring properties, a daylight and sunlight assessment has to accompany the planning application.

The daylight and sunlight assessment includes the necessary information to meet the criteria outlined in the Site layout planning for daylight and sunlight: a guide to good practice published by the Building Research Establishment (BRE).

4. Guidance document

4.1. Building Research Establishment (BRE) report (BRE 209): "Site layout planning for daylight and sunlight: A guide to good practice" Second Edition (2011)

The Second Edition of the report replaces the 1991 document of the same name and came into effect from October 2011.

It is important to note that the introduction to the report stresses that the document is provided for guidance purposes only and it is not intended to be interpreted as a strict and rigid set of rules. It also recommends that it may be appropriate to adopt a flexible approach and alternative target values in dealing with "special circumstances" for example "in a historic city centre, or in an area with modern high-rise buildings, a higher degree of obstruction may be unavoidable if new developments are to match the height and proportions of existing buildings". This is amplified by the following extracts from the introduction (p1, para. 6) and Section 2.2:

"The advice given here is not mandatory and this document should not be seen as an instrument of planning policy; its aim is to help rather than constrain the designer. Although it gives numerical guidelines, these should be interpreted flexibly because natural lighting is only one of many factors in site layout design". (p1, para. 1.6)

"In special circumstances the Developer or Planning Authority may wish to use different target values". (p1, para. 1.6)

"Note that numerical values given here are purely advisory. Different criteria may be used, based upon the requirements for daylight in an area viewed against other site layout constraints. Another important issue is whether the existing building is itself a good neighbour, standing a reasonable distance from the boundary and taking no more than its fair share of light". (p7 para. 2.2.3)

The examples given in the report can be applied to any part of the country: suburban, urban and rural areas. The inflexible application of the target values given in the report may make reaching the BRE criteria difficult in a tight, urban environment where there is unlikely to be the same expectation of daylight and sunlight amenity as in a suburban or rural environment.

5. Assessment methodology

5.1. General

When assessing any potential effects on the surrounding properties, the BRE guidelines suggest that only those windows that have a reasonable expectation of daylight or sunlight need be assessed. In particular the BRE guidelines at paragraph 2.2.2 state:

“The guidelines given here are intended for use for rooms in adjoining dwellings where daylight is required, including living rooms, kitchens and bedrooms. Windows to bathrooms, toilets, storerooms, circulation areas and garages need not be analysed. The guidelines may also be applied to any existing non-domestic buildings where the occupants have a reasonable expectation of daylight; this would normally include schools, hospitals, hotels and hostels, small workshops and some offices.”

Further to the above statement, it is considered that the vast majority of commercial properties do not have a reasonable expectation of daylight or sunlight. This is because they are generally designed to rely on electric lighting rather than natural daylight or sunlight.

This report assesses the potential impact of the proposed development in relation to daylight, sunlight and overshadowing on the buildings at Euston House, Ian Hamilton House and 10-12 Doric Way. Specifically, it takes into consideration the possible effect and influence that the new development would have on the properties.

17 target surfaces (S1 to S17) for external levels of daylight VSCs (Vertical Sky Components) and sunlight availability, as shown in section 9.4 in Appendix, have been selected based on anticipated worst case impact judged from professional experience and also following guidance within the BRE guidelines *“Site layout planning for daylight and sunlight”*.

Three existing amenity areas/gardens/open spaces have been identified on the drawings and/or site plan at 10-12 Doric Way and 40 Eversholt Street.

The IES Virtual Environment modelling software utilised for the compilation of this report has been accredited by CIBSE and acknowledged by the BRE as a suitable software tool for undertaking daylight, sunlight and overshadowing assessments in accordance with the BRE Good Practice guidelines. The specific IES software modules utilised for this assessment are the following:

- ModelIT: enables you to create a 3D "Virtual Environment" model without CAD data, or alternatively allows you to create a 3D model from 2D CAD data. Interfaces with AutoCAD and Google Sketchup.
- Radiance: is a detailed 3D simulation tool designed to predict daylight and electric light levels, and the appearance of a space prior to construction. Vertical Sky Components (VSC) and Average Daylight Factors (ADF) can be simulated using Radiance.
- SunCast: produces visual, graphical and numerical information that can be used to explain to colleagues, clients and planning authorities how the sun impacts on and inside the building, and on the site.

If a property is considered to have a reasonable expectation of daylight or sunlight the following methodology to assess the impacts has been used.

5.2. BRE Digest 209: "Site layout planning for daylight and sunlight"

This section provides a brief description of the calculating methods for the daylight, sunlight and overshadowing to gardens and open spaces criteria presented in BRE Digest 209.

5.2.1. Daylight

The BRE guidelines "Site layout planning for daylight and sunlight" incorporate two main methods of calculating daylight: the Vertical Sky Component (VSC) method and the Average Daylight Factor (ADF) method.

The VSC method measures the amount of light available on the outside plane at the centre of a window, as a ratio (expressed as a percentage) of the amount of total unobstructed sky visible following the introduction of visible barriers such as buildings.

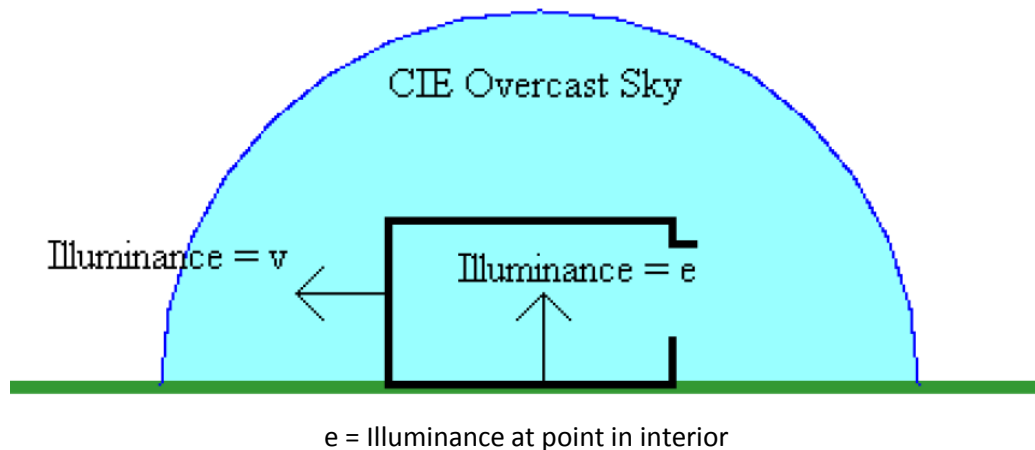
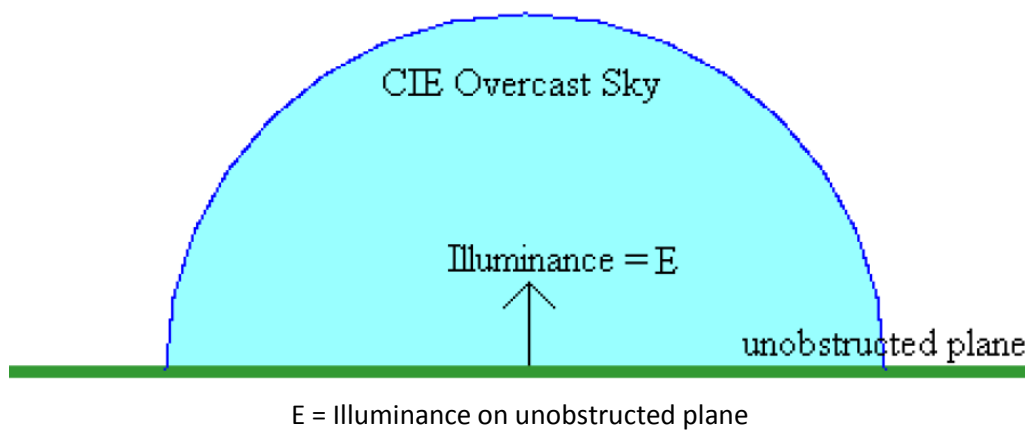

$$\text{Sky component} = e/E \text{ (often expressed as a percentage \%)}$$

$$\text{Vertical Sky Component (VSC)} = v/E \%$$

In this assessment, VSC is selected and more details on the numerical criteria for the VSC method are presented in section 9.6.

5.2.2. Sunlight

The BRE guidelines *"Site layout planning for daylight and sunlight"* recommend that access to sunlight is assessed with a development proposal. Potential impacts on available sunlight were assessed using the BRE's Annual Probable Sunlight Hours (APSH) method. This method involves the forecasting of sunlight availability throughout the year and in the winter months, for the main window of each habitable room that faces within 90° of due south. The buildings surrounding the site that do not contain windows that face within 90° of due south has been excluded from the sunlight assessment.

To provide a concise and comprehensive indicative analysis, the closest surfaces within the surrounding properties were analysed for both daylight and sunlight. Their locations are shown in section 9.4.1 in Appendix.

More details on the numerical criteria for the APSH method are presented in section 9.7.

5.2.3. Overshadowing to gardens and open spaces

The BRE guidelines *"Site layout planning for daylight and sunlight"* provide sunlight availability criteria for open spaces. In particular it gives guidance for calculating any areas of open space that may be in permanent shadow on 21st March.

In summary the BRE document states:

"It is suggested that, for it to appear adequately sunlit throughout the year, at least half of a garden or amenity area should receive at least two hours of sunlight on 21st March. If as a result of new development, an existing garden or amenity area does not meet these guidelines, and the area which can receive two hours of sun on 21st March is less than 0.8 times its former value, then the loss of sunlight is likely to be noticeable".

For this assessment the IES "Virtual Environment" SunCast software package has been used. A 3D model of the proposed and surrounding buildings was first modelled and the sunlight-tracking feature within the software used to view the shadow results. The study illustrated the extent of the shadow on one key date:

- March 21 (Spring Equinox)

More details on the numerical criteria for the overshadowing method are presented in section 9.8.

6. BRE Digest 209: Significant criteria

6.1. Daylight

The daylight criteria given within the BRE guidelines have been used as a basis to assess the potential impacts of the development:

"The daylighting is not considered to be substantially affected when the Vertical Sky Component (VSC) measured at the centre of a window is >27%. A window may be adversely affected if the VSC measured at the centre of the window is less than 27% and less than 0.8 times its former value".

In the assessment, the reduction between existing and proposed situations is expressed as a percentage, where a change in daylight levels above 20% equates to a figure of less than 0.8 times its former value.

Assessment points that do not meet the above criteria require further considerations to show the level of impact likely to be incurred.

6.2. Sunlight

The sunlight criteria given within the BRE guidelines have been used as a basis to assess the potential impacts of the development:

"A window may be adversely affected if a point at the centre of the window receives in the year less than 25% of the Annual Probable Sunlight Hours (APSH) including at least 5% of the APSH during the winter months (21st October to 21st March)".

Assessment points that do not meet the above criteria require further considerations to show the level of impact likely to be incurred.

6.3. Overshadowing to gardens and open spaces

The sunlight criteria given within the BRE guidelines have been used as a basis to assess the potential impacts of the development:

"It is suggested that, for it to appear adequately sunlit throughout the year, at least half of a garden or amenity area should receive at least two hours of sunlight on 21st March. If as a result of new development, an existing garden or amenity area does not meet these guidelines, and the area which can receive two hours of sun on 21st March is less than 0.8 times its former value, then the loss of sunlight is likely to be noticeable".

Assessment points that do not meet the above criteria require further considerations to show the level of impact likely to be incurred.

6.4. Criteria for assessing daylight, sunlight and overshadowing effects

The table 1 is a summary of the criteria to assess daylight, sunlight and overshadowing impacts:

Magnitude of effect	Criteria		
Beneficial	An improvement ratio > 1.3 of the baseline value		
Negligible	Daylight	Sunlight	Overshadowing
	A VSC of 27% or above in the proposed scenario with adequate daylight distribution	An APSH of 25%, of which 5% are in the winter months	50% of any amenity areas receiving at least 2 hours of direct sunlight on 21 st March
	Or	Or	Or
	A reduction ratio <1.0 and ≥ 0.8 of the baseline value	A reduction ratio <1.0 and ≥ 0.8 of the baseline value	A reduction ratio <1.0 and ≥ 0.8 of the baseline value
Minor adverse	A reduction ratio <0.8 and ≥ 0.7 of the baseline value		
Moderate adverse	A reduction ratio <0.7 and ≥ 0.6 of the baseline value		
Major adverse	A reduction ratio <0.6 of the baseline value		

Table 1: Criteria for assessing daylight, sunlight and overshadowing effects

Please note that in terms of daylight and sunlight BRE considers that a reduction in daylight or sunlight of less than 20% is not likely to be materially noticeable to occupiers of buildings. Our report then uses 10% increments of exceedance above the relevant threshold to be able to make the difference between minor, moderate and major adverse impact.

7. Assessment

7.1. BS 8206-2: 1992

The foreword to BS 8206-2: 1992 states that:

“The aim of the standard is to give guidance to architects, builders and others who carry out lighting design. It is recognised that lighting is only one of many matters that influence fenestration. These include other aspects of environmental performance (such as noise, thermal equilibrium and the control of energy use), fire hazards, constructional requirements, the external appearance and the surroundings of the site. The best design for a building does not necessarily incorporate the ideal solution for any individual function. For this reason, careful judgement should be exercised when using the criteria given in the standards for other purposes, particularly town planning control.”

7.2. Daylight

The daylight results are presented in section 9.6 in Appendix. The images and results show and compare the external levels of daylight (VSC – Vertical Sky Components) on the surfaces at Euston House, Ian Hamilton House and 10-12 Doric Way with and without the proposed development.

A summary of results is displayed in the table 2 below:

Daylight assessment (Surrounding buildings)				
Building Target surface	VSC (existing) >27%	VSC (proposed) >27%	Ratio	Result
Surface 1 – Euston House - GF	26.32	24.54	0.93	Negligible
Surface 2 – Euston House - FF	32.55	30.50	0.94	Negligible
Surface 3 – Euston House - FF	32.41	30.26	0.93	Negligible
Surface 4 – Ian Hamilton House - GF	18.36	17.98	0.98	Negligible
Surface 5 – Ian Hamilton House - GF	15.12	14.91	0.99	Negligible
Surface 6 – Ian Hamilton House - FF	24.43	23.13	0.95	Negligible
Surface 7 – Ian Hamilton House - FF	21.11	20.07	0.95	Negligible
Surface 8 – Ian Hamilton House - SF	31.82	29.27	0.92	Negligible
Surface 9 – Ian Hamilton House - SF	29.68	27.21	0.92	Negligible
Surface 10 – 10 Doric Way - GF	26.13	25.18	0.96	Negligible
Surface 11 – 10 Doric Way - GF	22.46	21.18	0.97	Negligible
Surface 12 – 10 Doric Way - FF	30.03	28.53	0.95	Negligible
Surface 13 – 10 Doric Way - FF	27.60	26.00	0.94	Negligible
Surface 14 – 12 Doric Way - GF	29.16	28.29	0.97	Negligible

Surface 15 – 12 Doric Way - GF	27.32	26.32	0.96	Negligible
Surface 16 – 12 Doric Way - FF	32.06	31.09	0.97	Negligible
Surface 17 – 12 Doric Way - FF	31.05	29.80	0.96	Negligible

Table 2: Daylight results

Note: For location of target surfaces, see Appendix section 9.4 “Site plan and location”

As can be seen in the above table, none of the surfaces will be adversely impacted by the proposed development.

- ✓ **The slight loss in daylight for the surfaces is not considered of concern as the proposed VSC levels are either above 27% or more than 0.8 times their former values and will provide adequate levels of daylight.**

→ **In terms of daylight the proposed scheme is considered acceptable.**

It should be noted that the values provided in the BRE 209 are for guidance purposes only.

7.3. Sunlight

Where necessary (as defined in the Assessment Methodology section of this report) Annual Probable Sunlight Hours (APSH) tests have been undertaken with the results presented in section 9.7 in the appendix.

The table below indicates the likely levels of sunlight on the surfaces at Euston House, Ian Hamilton House and 10-12 Doric Way with and without the proposed development.

A summary of results is displayed in the table 3 below:

Building Target surface	Sunlight assessment (Surrounding buildings)						Result
	Total APSH >25%		Winter APSH >5%		Ratio Annual	Ratio Winter	
	Existing	Proposed	Existing	Proposed			
Surface 1 – Euston House - GF	N/A	N/A	N/A	N/A	N/A	N/A	N/A
Surface 2 – Euston House - FF	N/A	N/A	N/A	N/A	N/A	N/A	N/A
Surface 3 – Euston House - FF	N/A	N/A	N/A	N/A	N/A	N/A	N/A
Surface 4 – Ian Hamilton House - GF	20	17	0	0	0.85	0	Negligible
Surface 5 – Ian Hamilton House - GF	10	9	0	0	0.90	0	Negligible
Surface 6 – Ian Hamilton House - FF	39	37	1	0	0.95	0	Negligible
Surface 7 – Ian Hamilton House - FF	27	24	0	0	0.89	0	Negligible
Surface 8 – Ian Hamilton House - SF	56	53	13	10	0.95	0.77	Negligible
Surface 9 – Ian Hamilton House - SF	47	44	5	2	0.94	0.40	Negligible
Surface 10 – 10 Doric Way - GF	44	42	4	2	0.95	0.50	Negligible
Surface 11 – 10 Doric Way - GF	33	31	0	0	0.94	0	Negligible
Surface 12 – 10 Doric Way - FF	54	52	12	10	0.96	0.83	Negligible
Surface 13 – 10 Doric Way - FF	43	40	7	4	0.93	0.57	Negligible
Surface 14 – 12 Doric Way - GF	52	51	10	9	0.98	0.90	Negligible
Surface 15 – 12 Doric Way - GF	51	48	9	6	0.94	0.67	Negligible
Surface 16 – 12 Doric Way - FF	57	56	14	13	0.98	0.93	Negligible
Surface 17 – 12 Doric Way - FF	56	54	13	11	0.96	0.85	Negligible

Table 3: Sunlight results

Note: For location of target surfaces, see Appendix section 9.4 "Site plan and location"

The table above demonstrates that, none of the surfaces will be adversely impacted by the proposed development.

N/A: Not applicable. The buildings surrounding or adjacent to each site that do not contain windows within 90° of due South have been excluded from the sunlight assessments. This is because sunlight is directional and North-facing windows in this location will only receive sunlight at the height of summer at occasional times. As such, pursuant to the BRE guide, North-facing windows are not considered to have a reasonable expectation of sunlight and do not require assessment.

- ✓ **The slight loss in sunlight for the surfaces is not considered of concern as the proposed total APSH are either above >25% of which more than 5% are in winter months or are more than 0.8 times their former values.**
- ✓ **There will be however some impact on winter sunlight in some cases (4 windows: S6-S9-S10-S13). This however, is inevitable due to the fact that winter sunlight is received from lower angles of altitude measure vertically from the horizontal. Furthermore, it should be noted that the existing winter sunlight values are already low and it is questionable as to whether any occupier would notice such a slight change in WSPH. Overall, we believe that the impact is unlikely to be noticeable and the impact is compensated by the levels of annual sunlight hours (APSH). Indeed, the criteria set by BRE is 25% APSH while on the impacted windows the APSH are ranging from 37% to 44% which surpass the BRE criteria.**

→ **In terms of sunlight the proposed scheme is considered acceptable.**

It should be noted that the values provided in the BRE 209 are for guidance purposes only.

7.4. Overshadowing

The following results represent the cumulative overshadowing impacts of the proposed development. As identified from the AutoCAD drawings and/or site plan, three existing amenity areas are located at 10-12 Doric Way and 40 Eversholt Street. In accordance with the BRE guidelines, overshadowing has been assessed during times of the day where the sun’s altitude is above 10° (from 7:30am to 5:00pm).

"It is suggested that, for it to appear adequately sunlit throughout the year, at least half of a garden or amenity area should receive at least two hours of sunlight on 21st March. If as a result of new development, an existing garden or amenity area does not meet these guidelines, and the area which can receive two hours of sun on 21st March is less than 0.8 times its former value, then the loss of sunlight is likely to be noticeable".

The pictures showing the overshadowing impact are indicated in section 9.8 of the Appendix.

A summary of results is displayed in the table 4 below:

Overshadowing assessment from 7.30am to 5.00pm % of area receiving sunlight on 21 st March				
Amenity area	Existing (%)	Proposed (%)	Ratio	Result
Amenity 1 – 10 Doric Way - Garden	2	1.33	0.66	/
Amenity 2 – 12 Doric Way - Garden	26.46	24.67	0.93	Negligible
Amenity 3 – 40 Eversholt Street - Garden	0.18	0	/	/

Table 4: Overshadowing results

Note: For location of target surfaces, see Appendix section 9.4 “Site plan and location”

As can be seen in the table above, the existing amenity area/garden/open space will not be adversely impacted by the proposed development.

- ✓ **The BRE criteria require at least 2 hours of direct sunlight on 21st March on 50% of the area or more. However, as it can be seen in more detail in the Appendix section 9.8, Amenity 1 and 3 do not meet the BRE criteria in the existing condition. Indeed, these 2 amenities barely receive any direct sunlight. As shown above, in existing conditions Amenity 1 receives direct sunlight on 2% of its area on average, 0.18% for amenity 2. Overall, we believe that the impact is unlikely to be noticeable by the occupants and we consider the results acceptable.**

→ In terms of overshadowing the proposed scheme is considered acceptable.

It should be noted that the values provided in the BRE 209 are for guidance purposes only.

8. Conclusion

8.1. Daylight

This report demonstrates that the levels of daylight at the surrounding buildings Euston House, Ian Hamilton House and 10-12 Doric Way are adequate.

BRE criteria met:

8.2. Sunlight

This report demonstrates that the levels of sunlight at the surrounding buildings Euston House, Ian Hamilton House and 10-12 Doric Way are adequate.

- ✓ **There will be however some impact on winter sunlight in some cases (4 windows: S6-S9-S10-S13). This however, is inevitable due to the fact that winter sunlight is received from lower angles of altitude measure vertically from the horizontal. Furthermore, it should be noted that the existing winter sunlight values are already low and it is questionable as to whether any occupier would notice such a slight change in WSPH. Overall, we believe that the impact is unlikely to be noticeable and the impact is compensated by the levels of annual sunlight hours (APSH). Indeed, the criteria set by BRE is 25% APSH while on the impacted windows the APSH are ranging from 37% to 44% which surpass the BRE criteria.**

BRE criteria met:

8.3. Overshadowing

This report demonstrates that the existing amenity area/garden/open spaces located at 10-12 Doric Way and 40 Eversholt Street will not be adversely impacted by the proposed development.

- ✓ **The BRE criteria require at least 2 hours of direct sunlight on 21st March on 50% of the area or more. However, as it can be seen in more detail in the Appendix section 9.8, Amenity 1 and 3 do not meet the BRE criteria in the existing condition. Indeed, these 2 amenities barely receive any direct sunlight. As shown above, in existing conditions Amenity 1 receives direct sunlight on 2% of its area on average, 0.18% for amenity 2. Overall, we believe that the impact is unlikely to be noticeable by the occupants and we consider the results acceptable.**

BRE criteria met:

On balance, it can be concluded that the surrounding buildings at Euston House, Ian Hamilton House and 10-12 Doric Way will not be adversely impacted by the proposed development.

 **The proposed scheme is considered acceptable.**

9. Appendix

9.1. Sunrise and sunset time

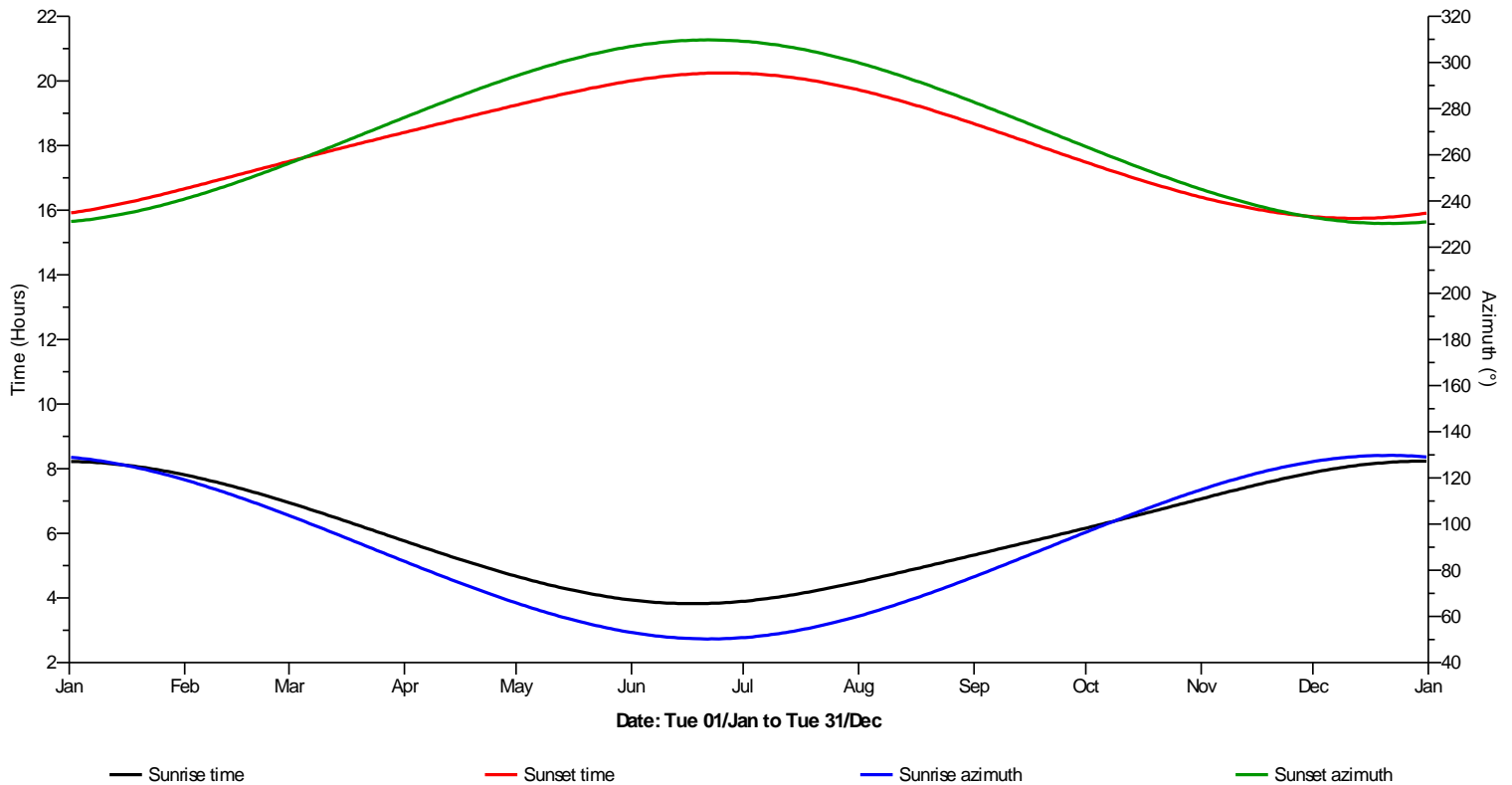

9.2. Sun path

Location: London/Heathrow
 Latitude: 51.48° N
 Longitude: 0.45° W (Local Time Meridian: 0.00° W)

Sun Paths Shown:

- June 21
- March 21
- September 21
- January 1
- December 31
- December 21

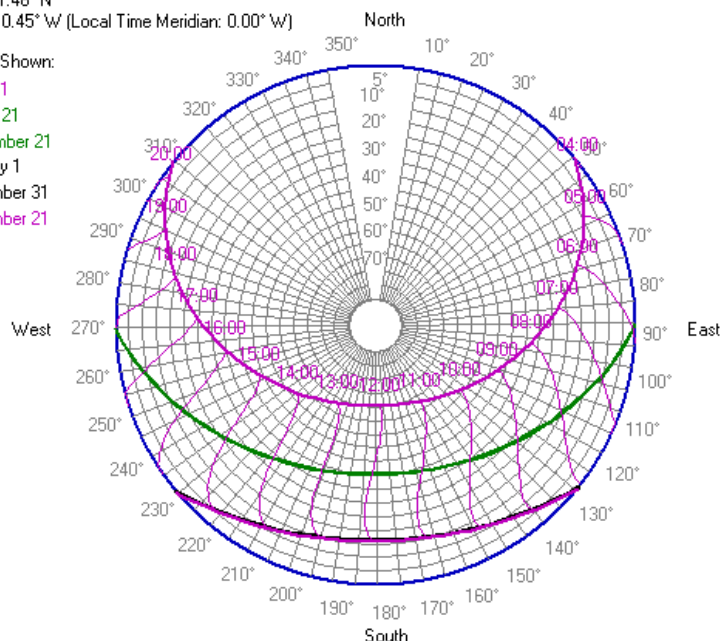

9.3. Suntrace

- ❖ The red line represents the sun's path during June.
- ❖ The yellow line represents the sun's path during March/September.
- ❖ The blue line represents the sun's path during December.

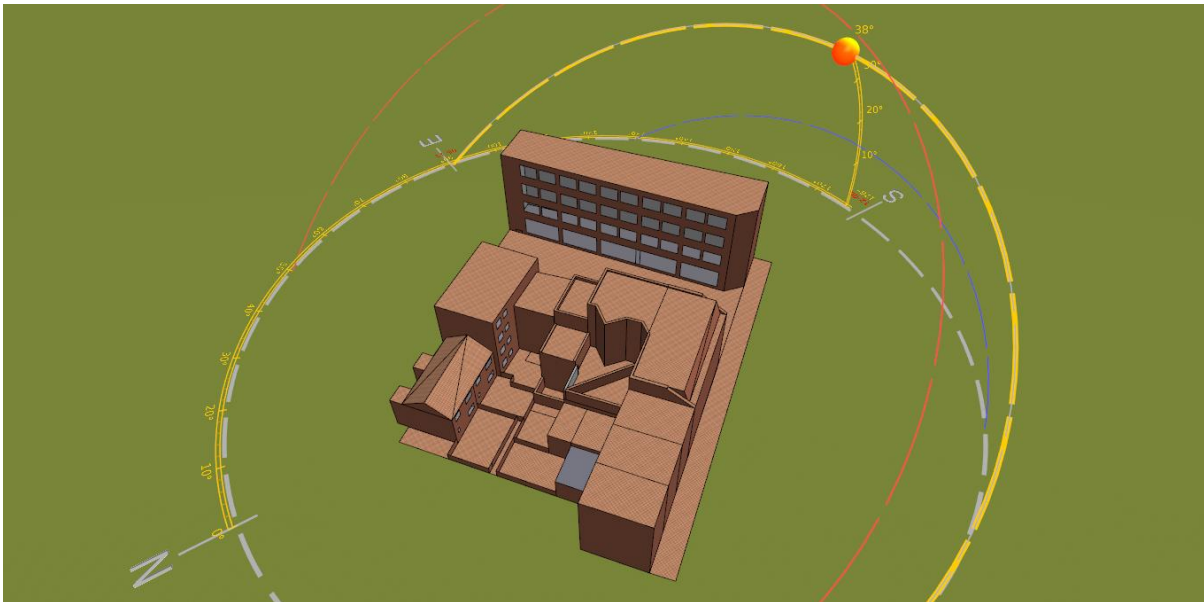
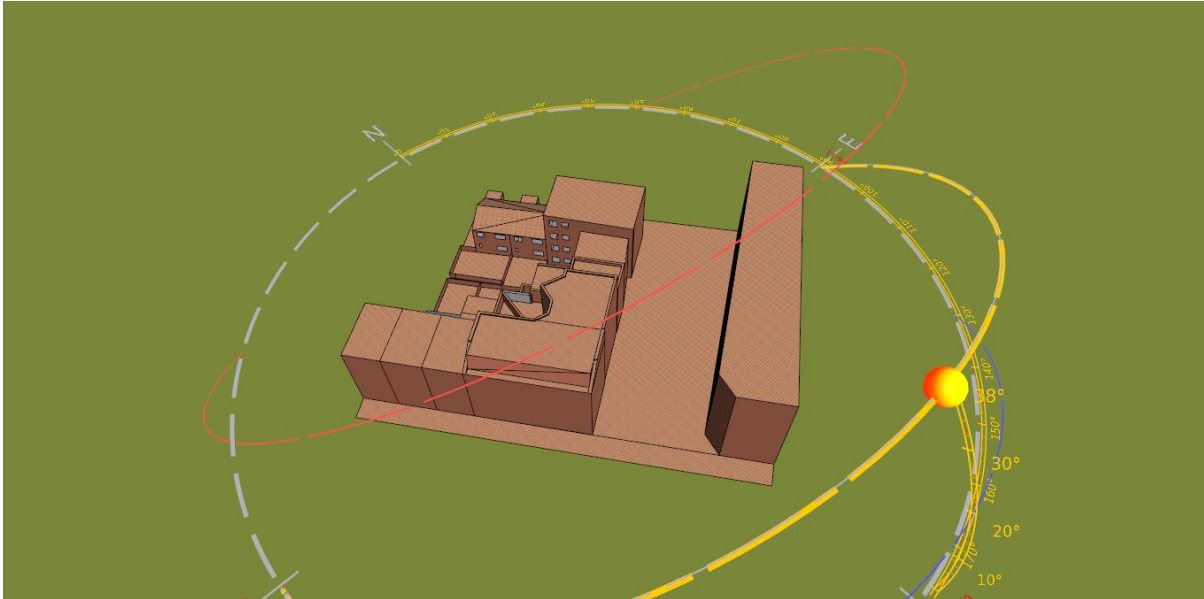

9.4. Site plan and location

9.4.1. Existing site layout



9.4.2. Proposed site layout

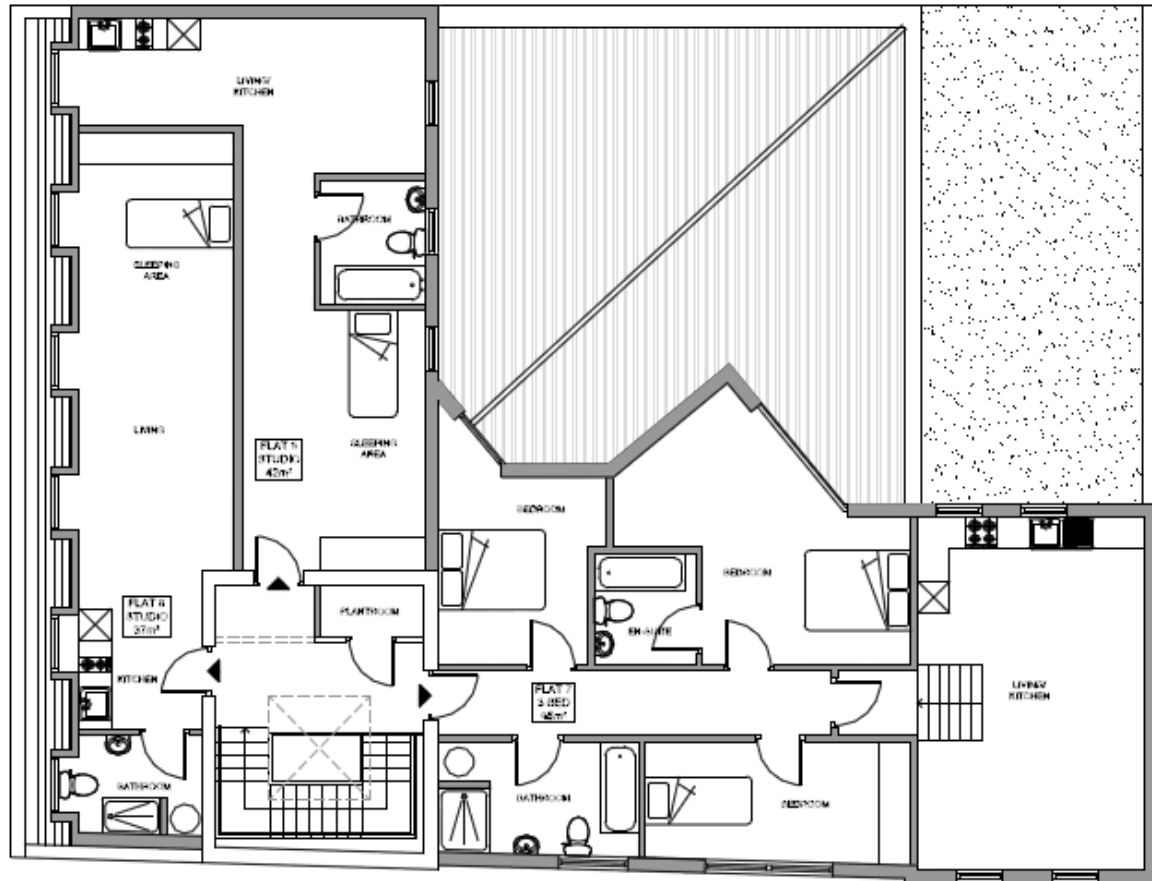

PROPOSED THIRD FLOOR PLAN

Proposed extension on top of existing roof



Euston House



12-10 Doric Way - Ian Hamilton House

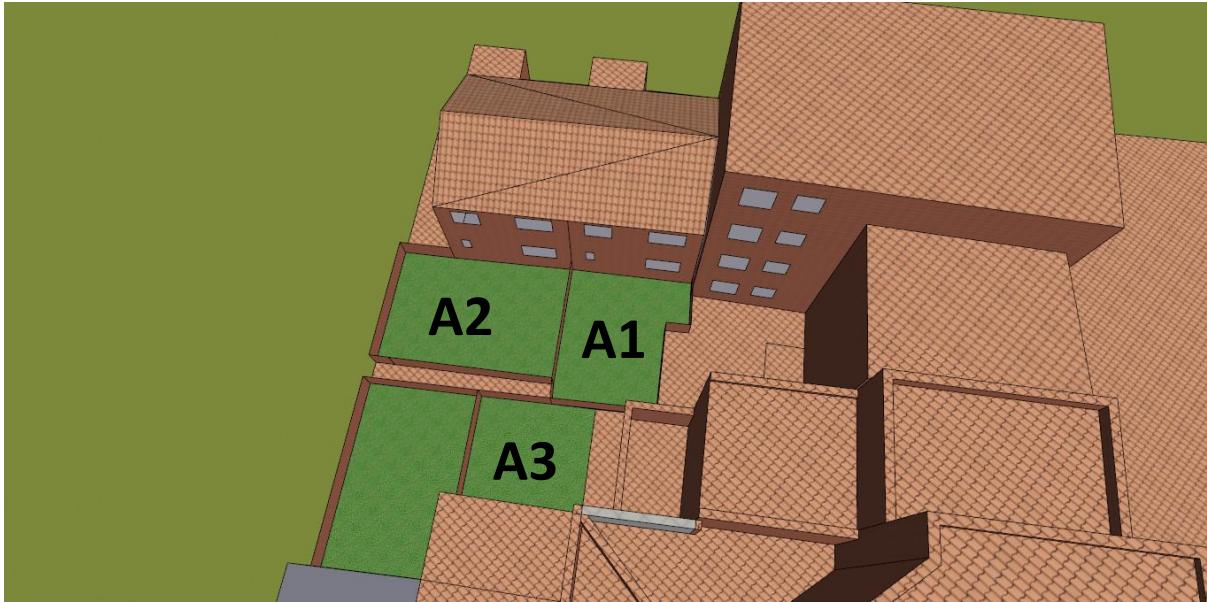

12-10 Doric Way - Ian Hamilton House

Location	34-38 Eversholt Street, London NW1 1DA
Latitude (°)	51.52 N
Longitude (°)	0.13 W

9.5. Model images

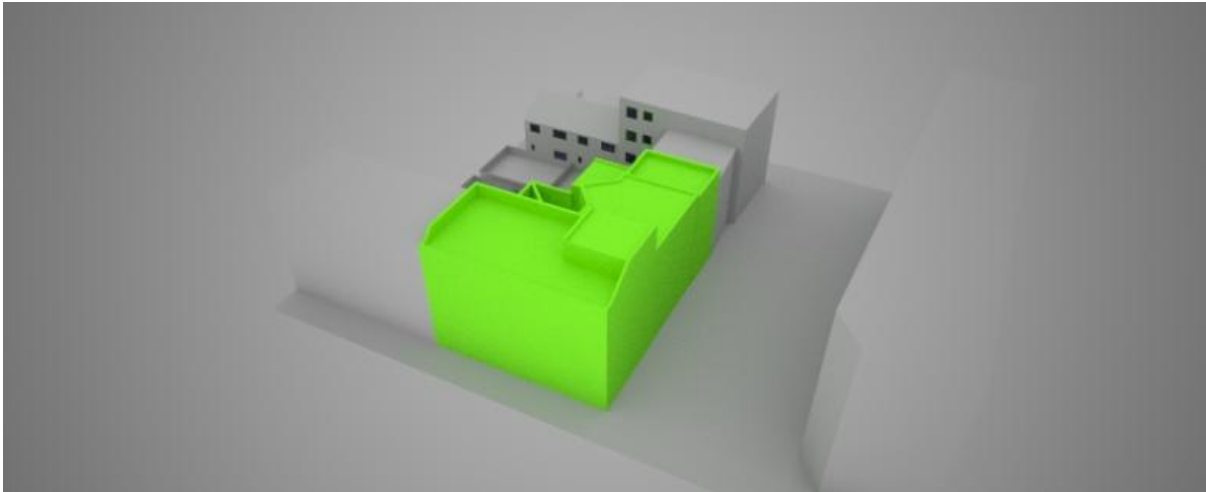

Existing scheme

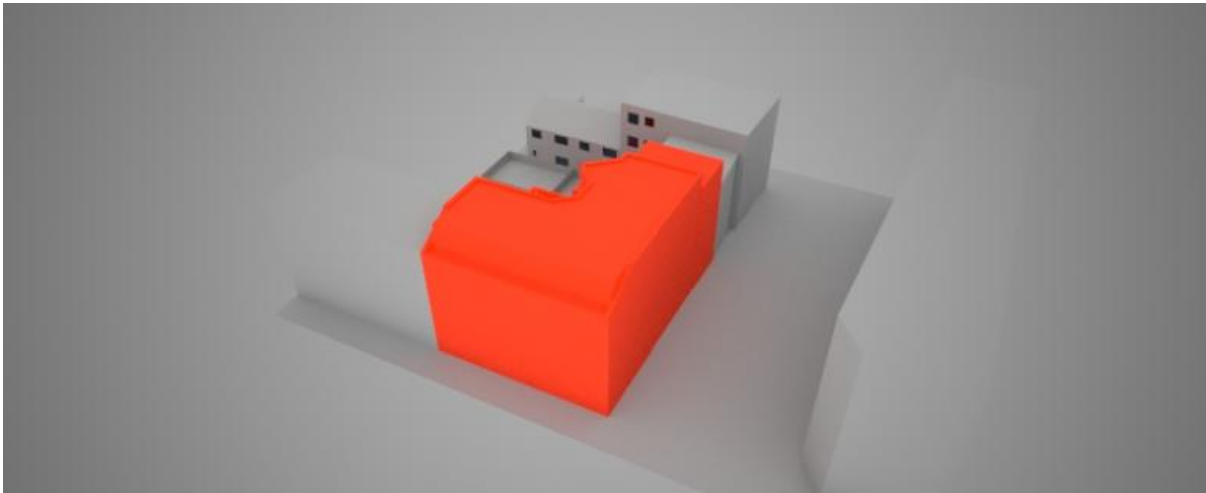

Proposed scheme

9.6. Daylight results

Surface 1 – Euston House - GF

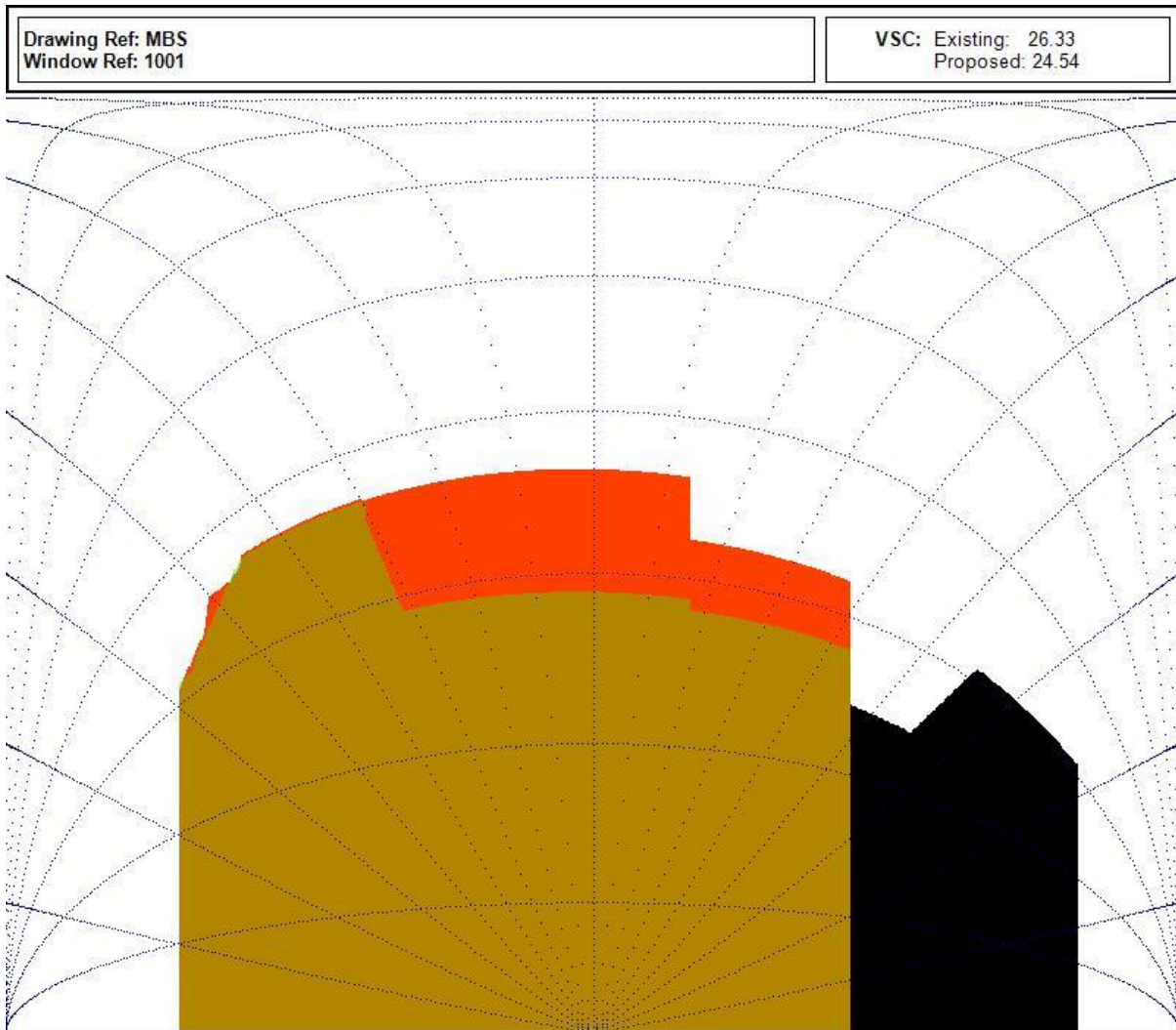

The green contour represents the existing building.
 The orange contour represents the proposed building.
 The black contour represents the surrounding buildings.

Surface 2 – Euston House - FF

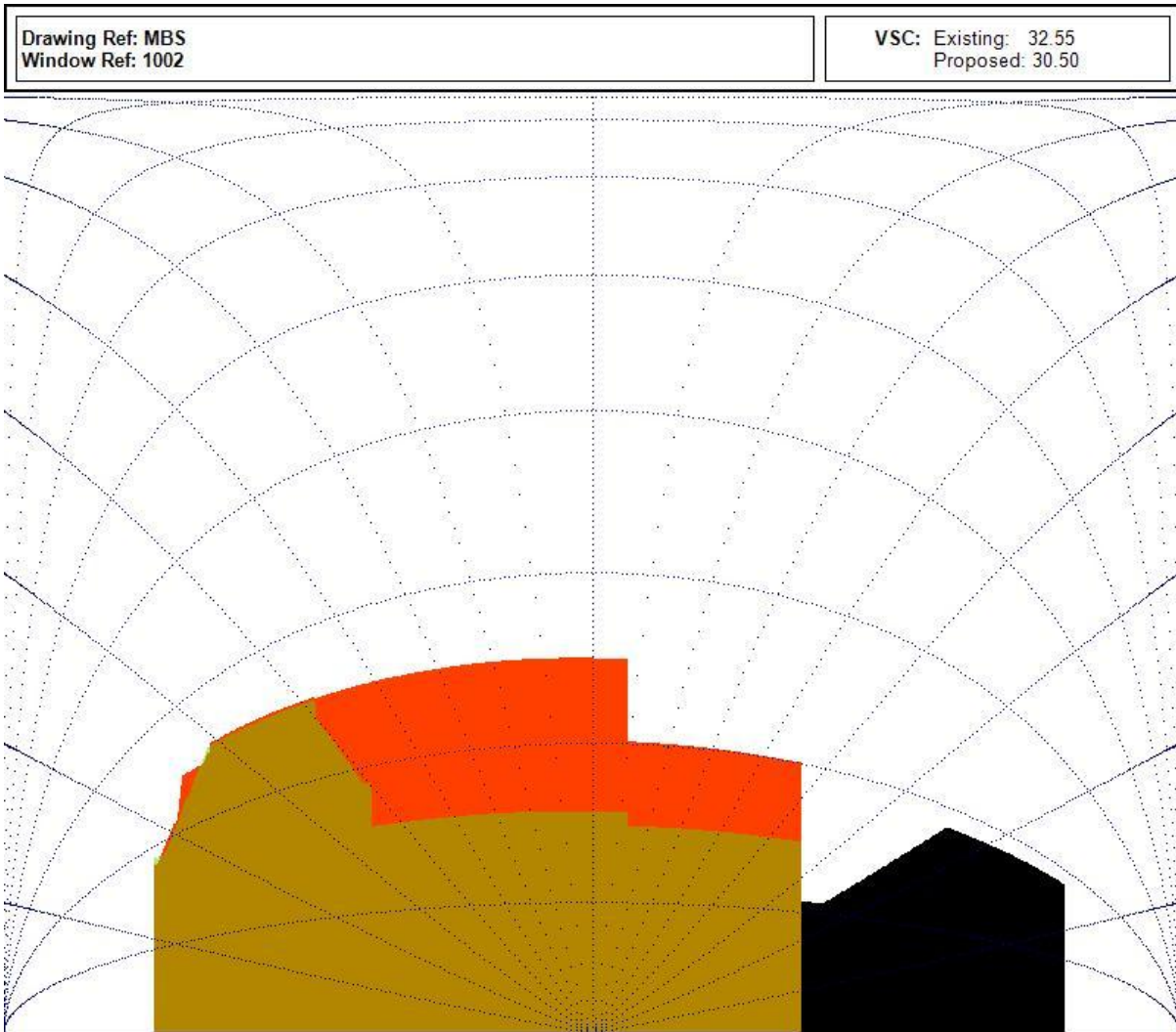

The green contour represents the existing building.
 The orange contour represents the proposed building.
 The black contour represents the surrounding buildings.

Surface 3 – Euston House - FF

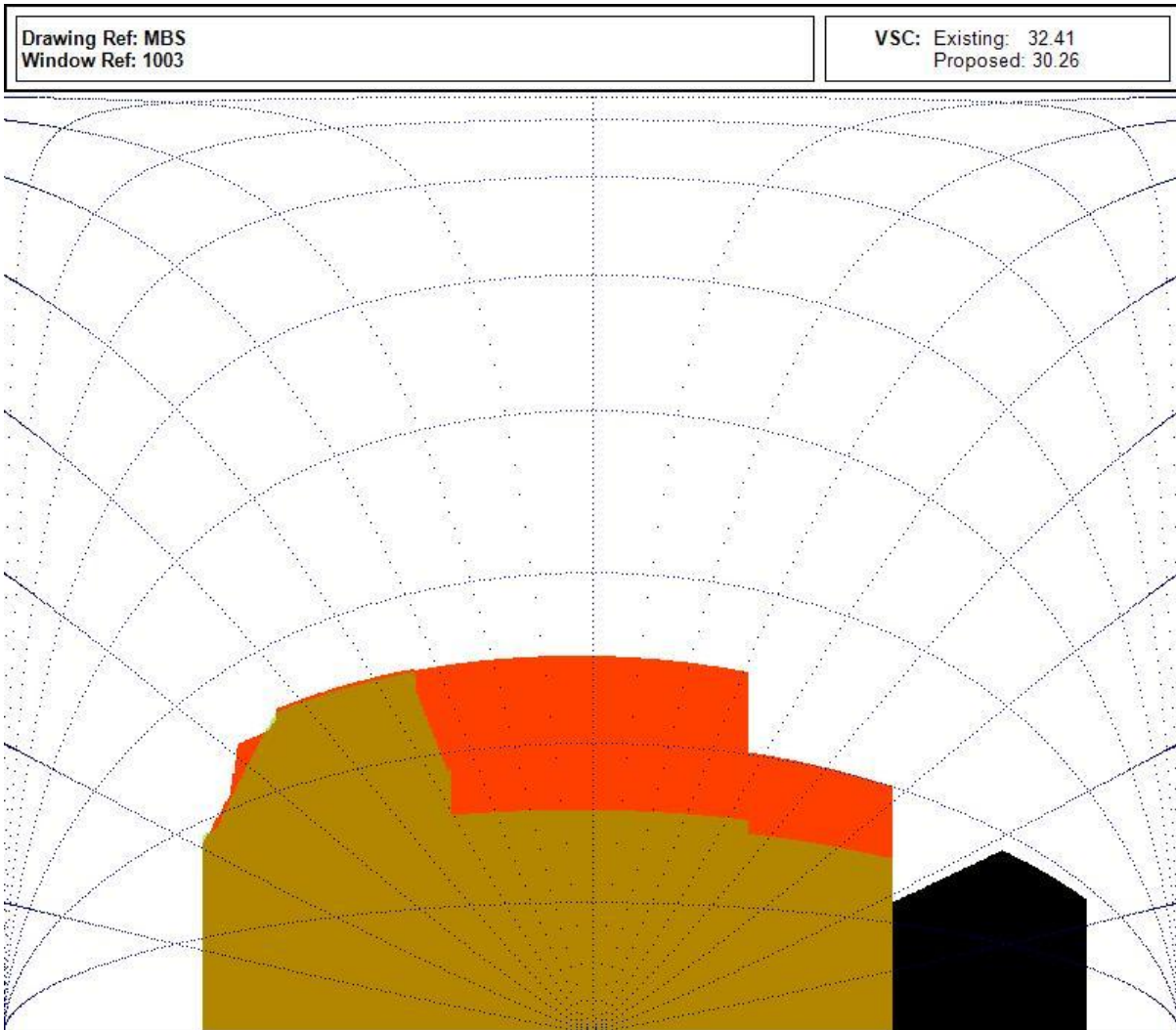

The green contour represents the existing building.
 The orange contour represents the proposed building.
 The black contour represents the surrounding buildings.

Surface 4 – Ian Hamilton House - GF

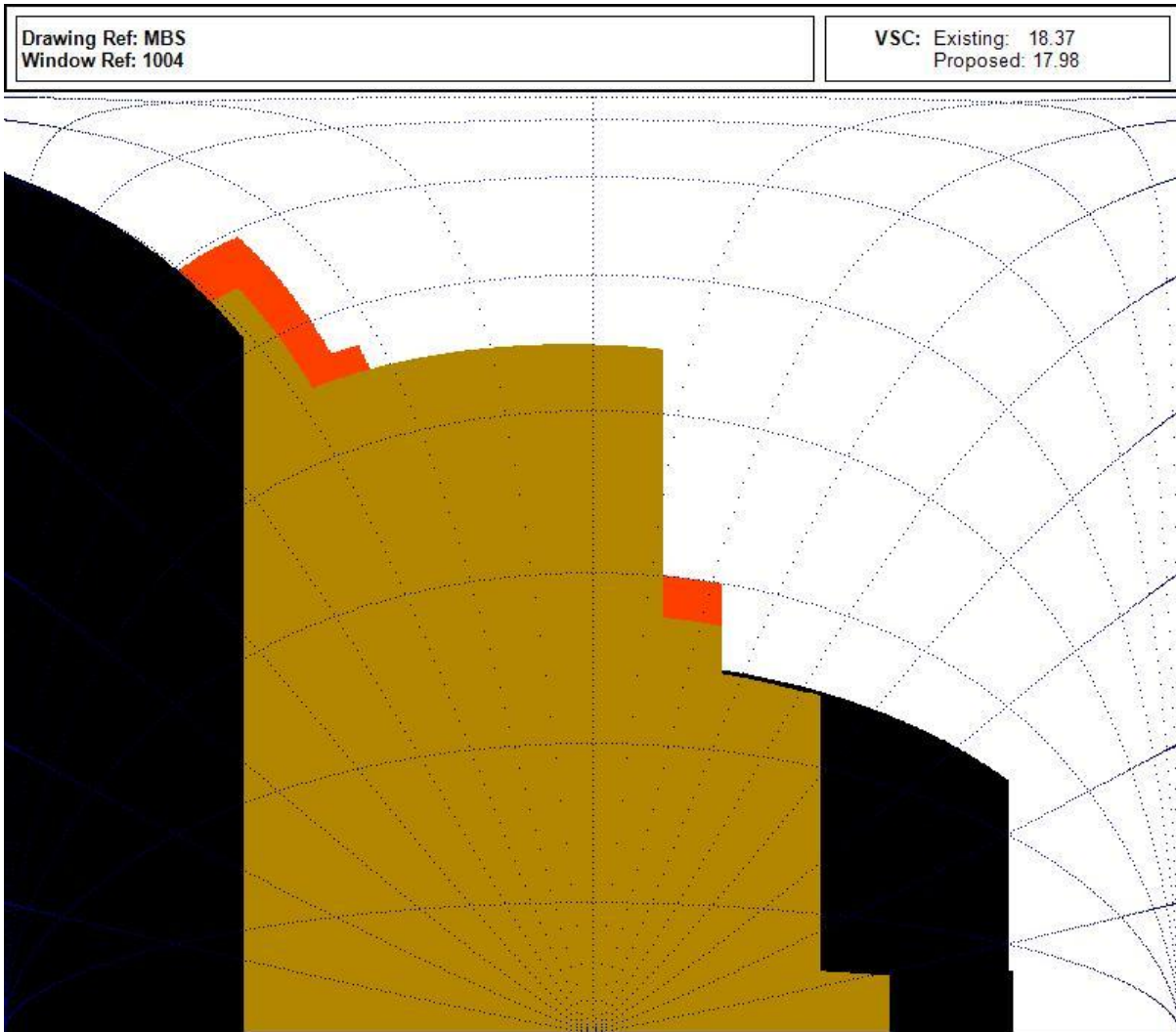

The green contour represents the existing building.
 The orange contour represents the proposed building.
 The black contour represents the surrounding buildings.

Surface 5 – Ian Hamilton House - GF

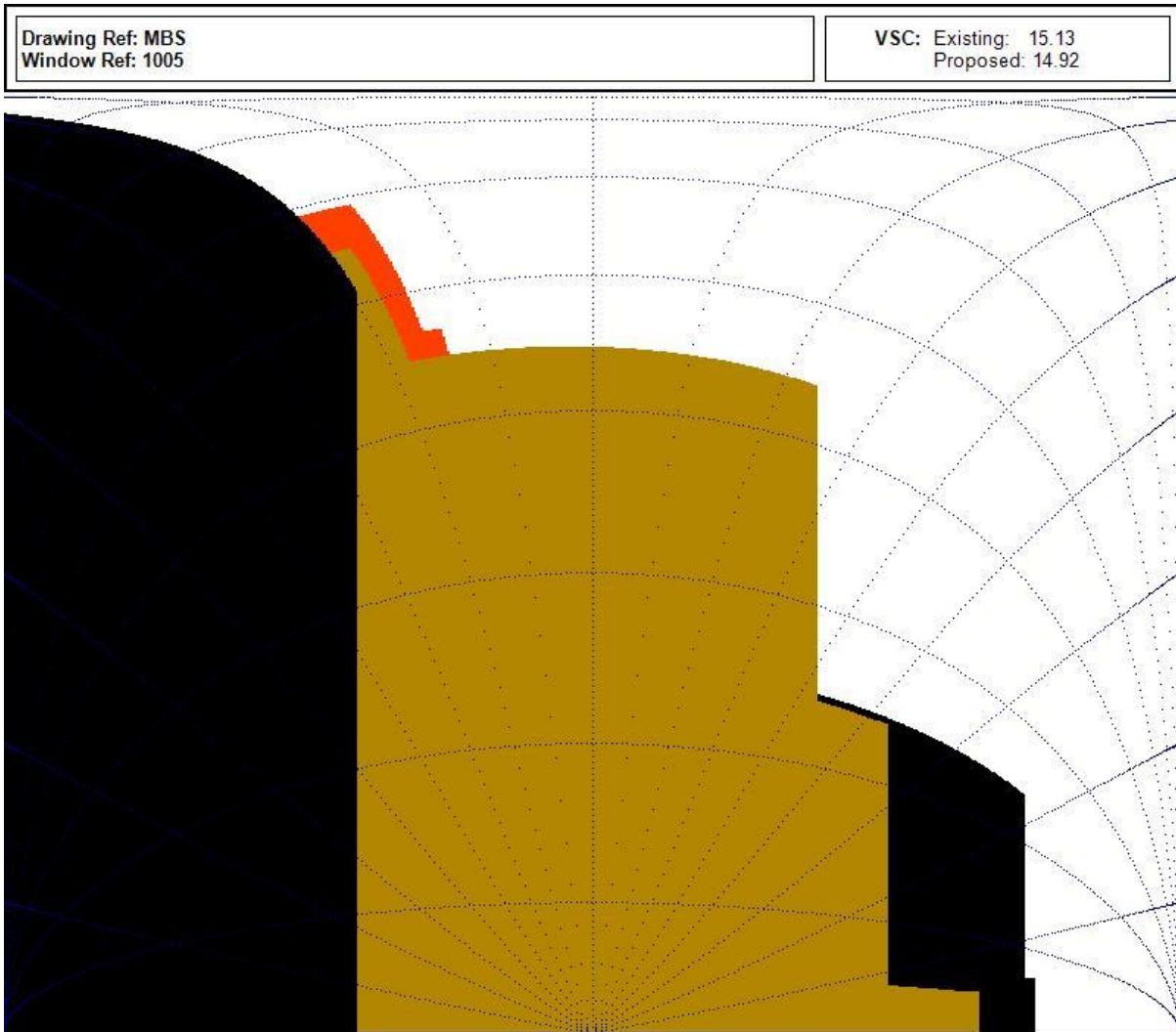

The green contour represents the existing building.
 The orange contour represents the proposed building.
 The black contour represents the surrounding buildings.

Surface 6 – Ian Hamilton House - FF

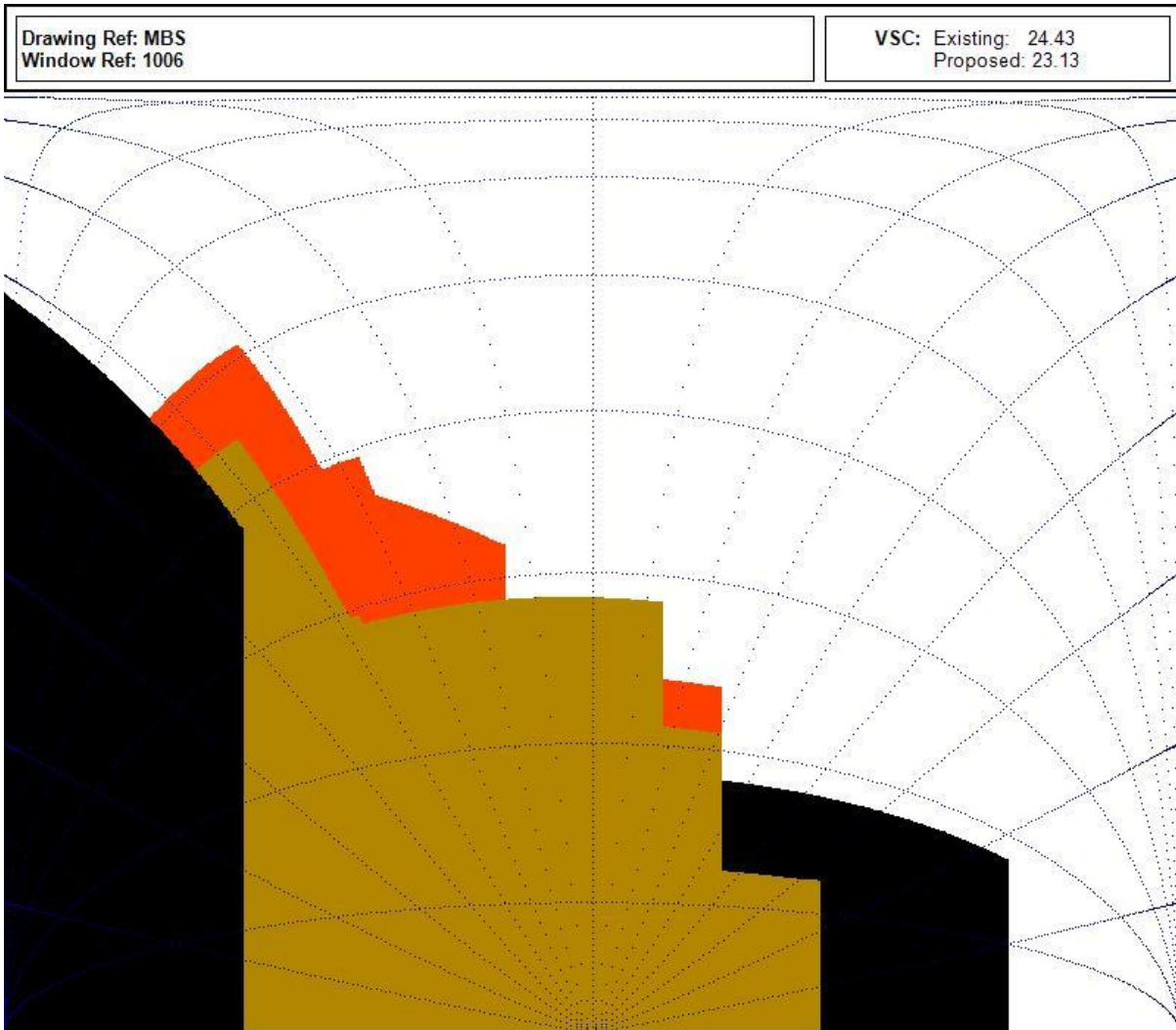

The green contour represents the existing building.
 The orange contour represents the proposed building.
 The black contour represents the surrounding buildings.

Surface 7 – Ian Hamilton House - FF

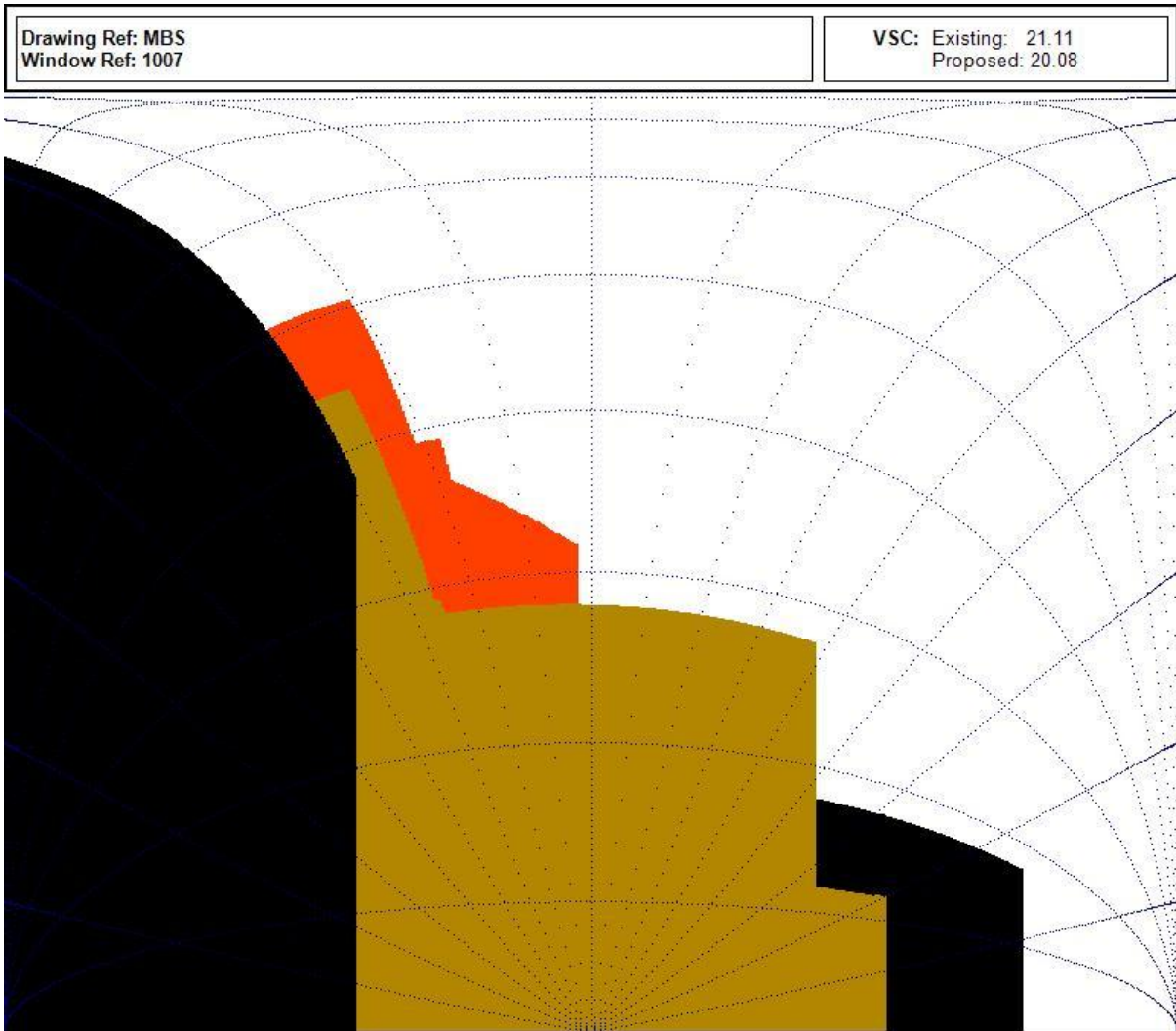

The green contour represents the existing building.
 The orange contour represents the proposed building.
 The black contour represents the surrounding buildings.

Surface 8 – Ian Hamilton House - SF

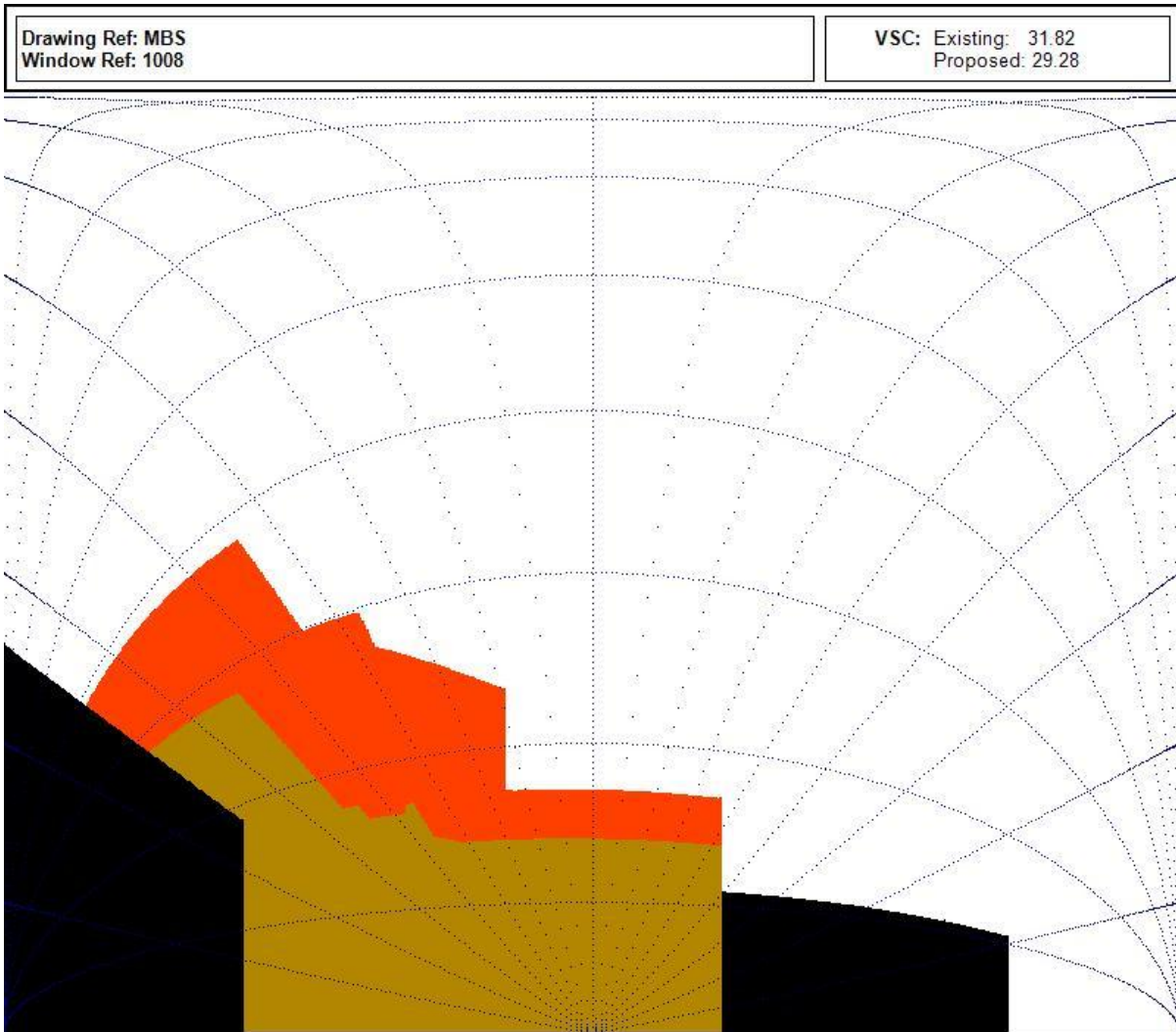

The green contour represents the existing building.
 The orange contour represents the proposed building.
 The black contour represents the surrounding buildings.

Surface 9 – Ian Hamilton House - SF

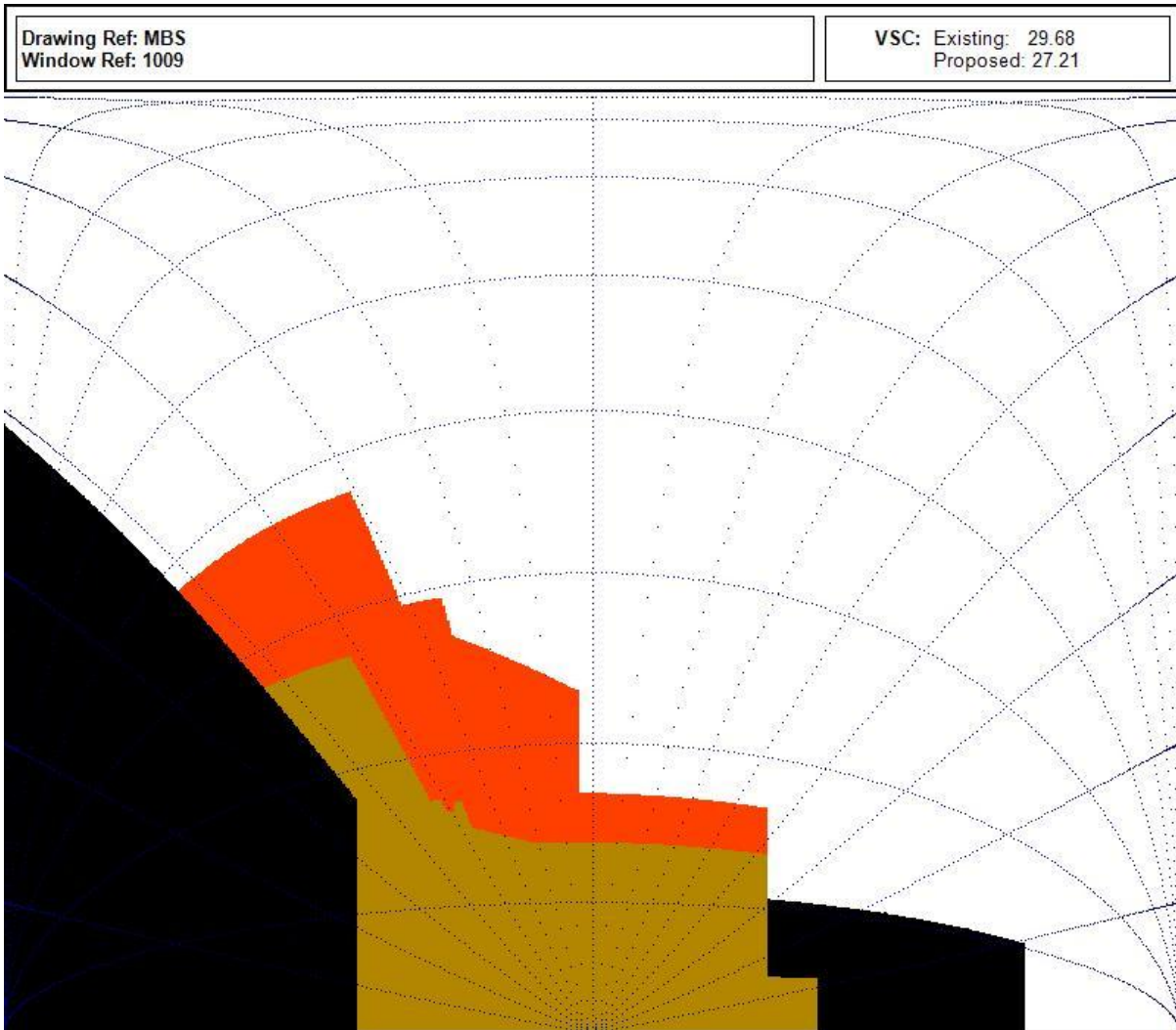

The green contour represents the existing building.
 The orange contour represents the proposed building.
 The black contour represents the surrounding buildings.

Surface 10 – 10 Doric Way - GF

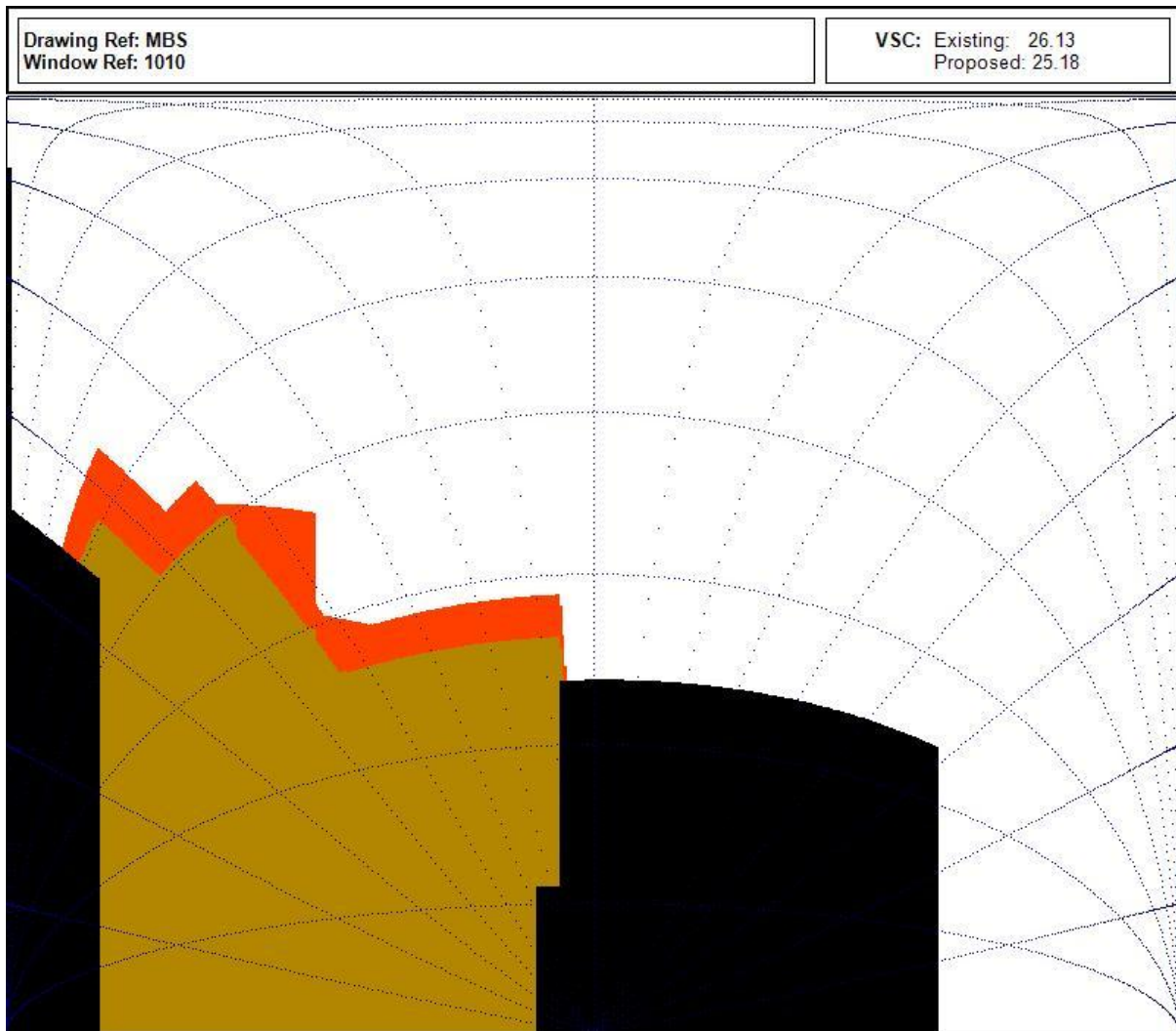

The green contour represents the existing building.
 The orange contour represents the proposed building.
 The black contour represents the surrounding buildings.

Surface 11 – 10 Doric Way - GF

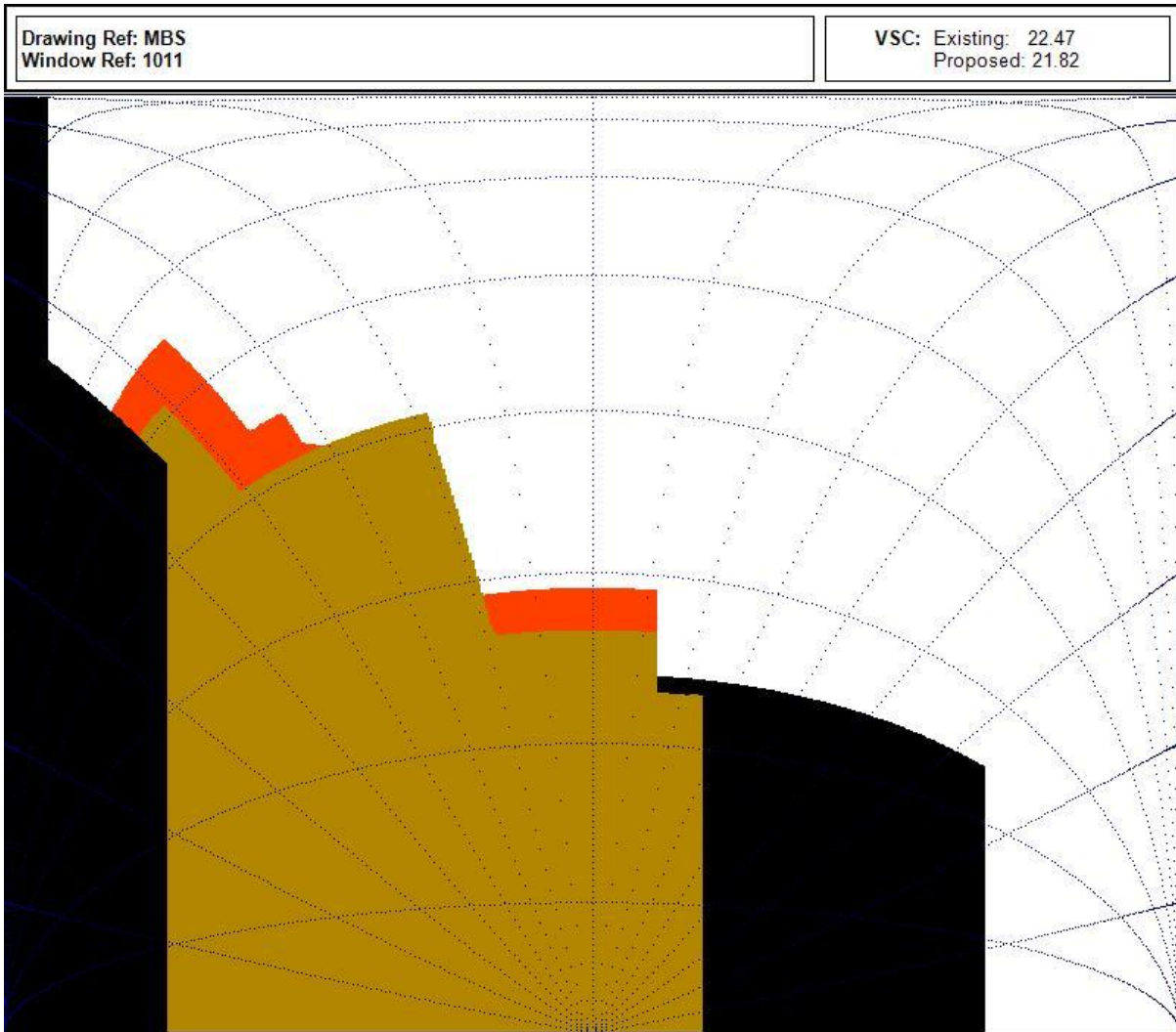

The green contour represents the existing building.
 The orange contour represents the proposed building.
 The black contour represents the surrounding buildings.

Surface 12 – 10 Doric Way - FF

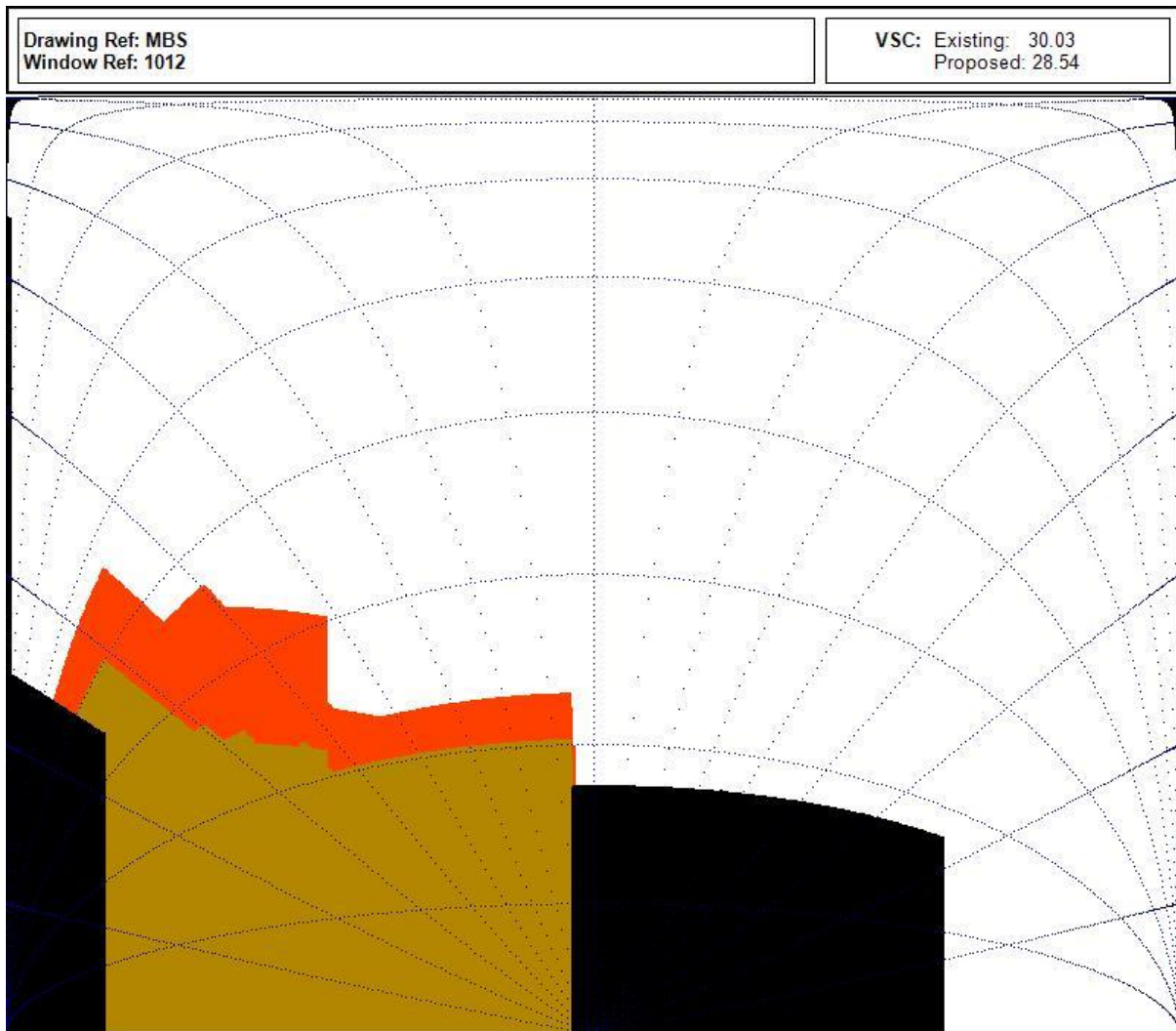

The green contour represents the existing building.
 The orange contour represents the proposed building.
 The black contour represents the surrounding buildings.

Surface 13 – 10 Doric Way - FF

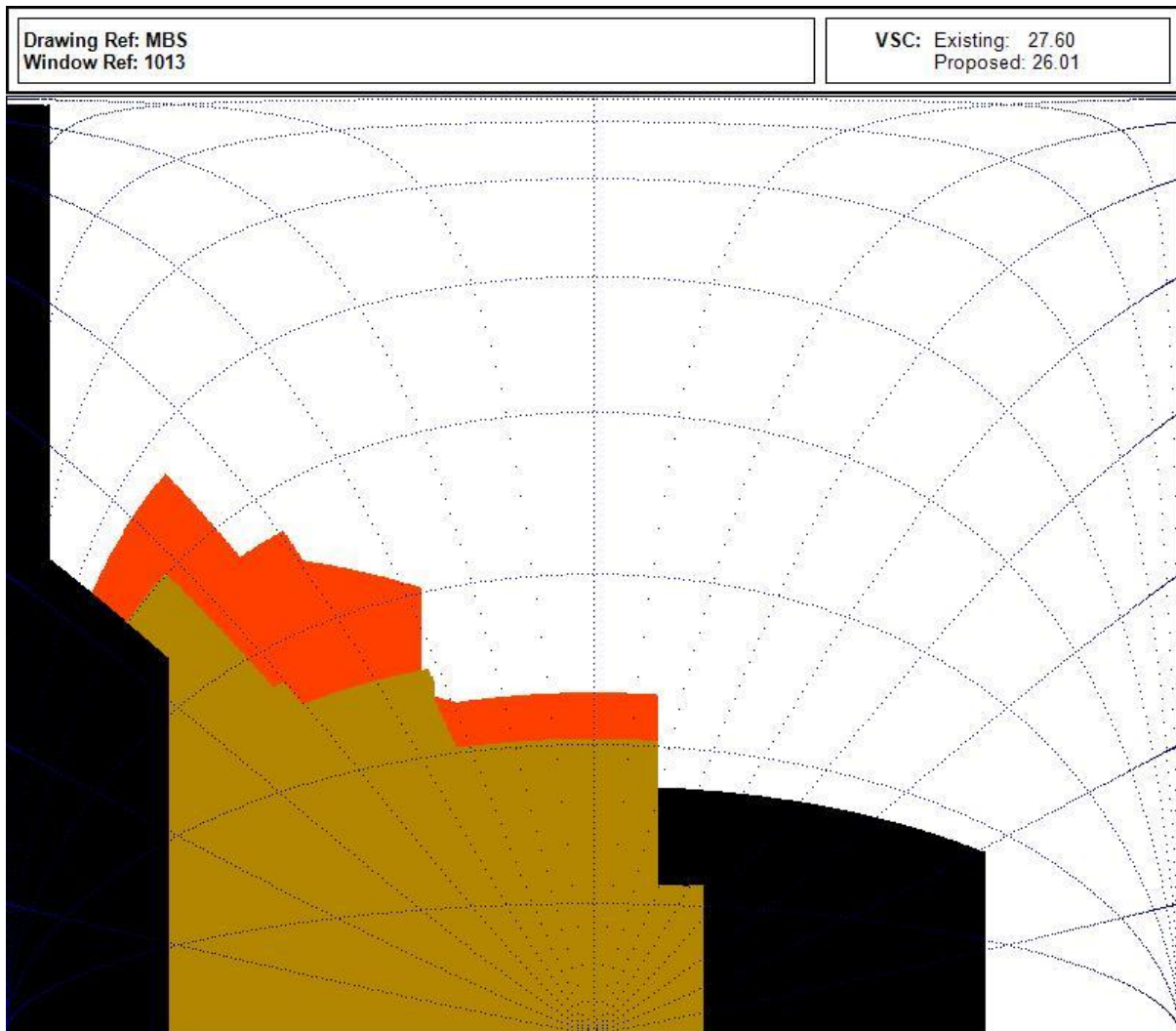

The green contour represents the existing building.
 The orange contour represents the proposed building.
 The black contour represents the surrounding buildings.

Surface 14 – 12 Doric Way - GF

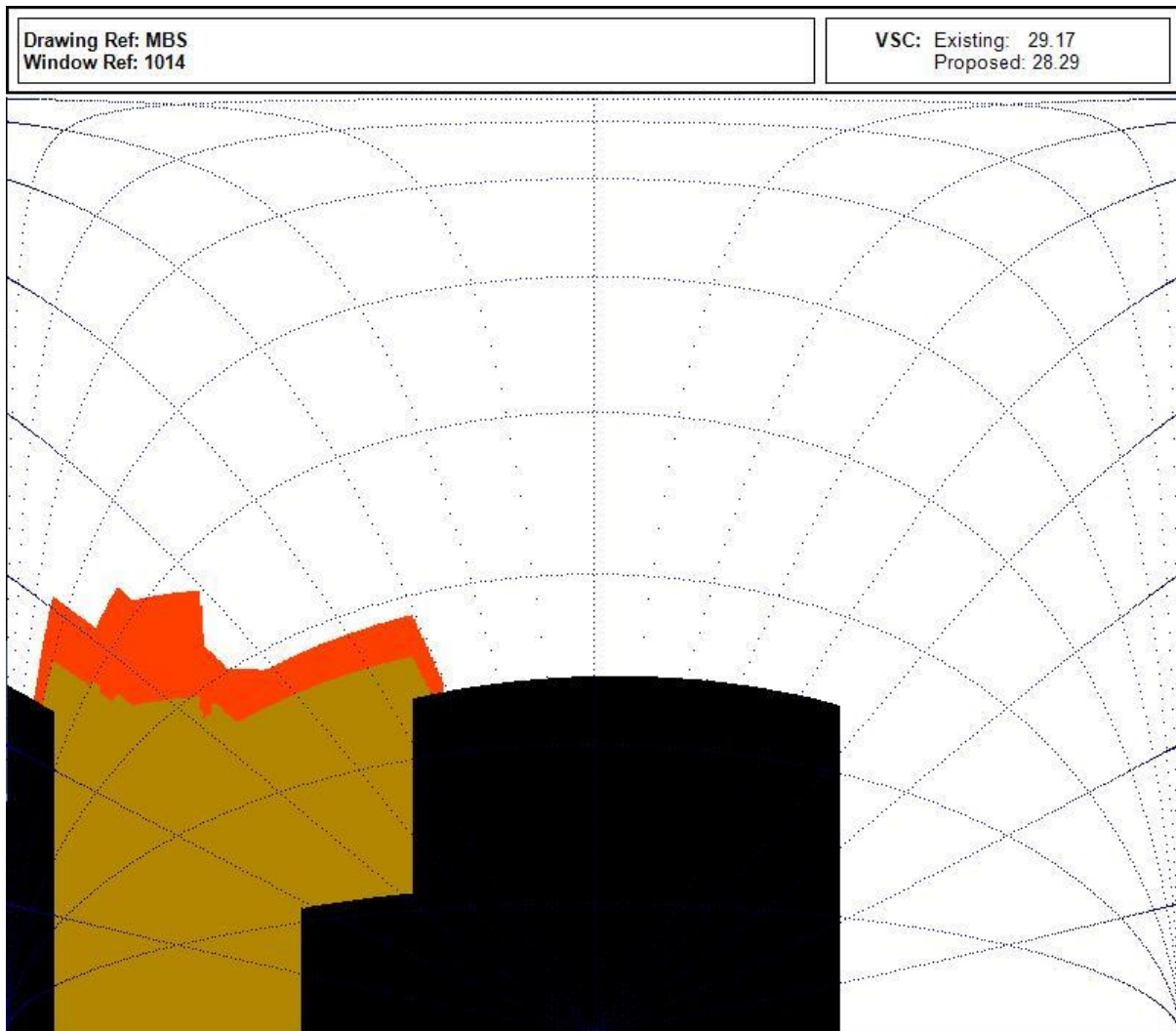

The green contour represents the existing building.
 The orange contour represents the proposed building.
 The black contour represents the surrounding buildings.

Surface 15 – 12 Doric Way - GF

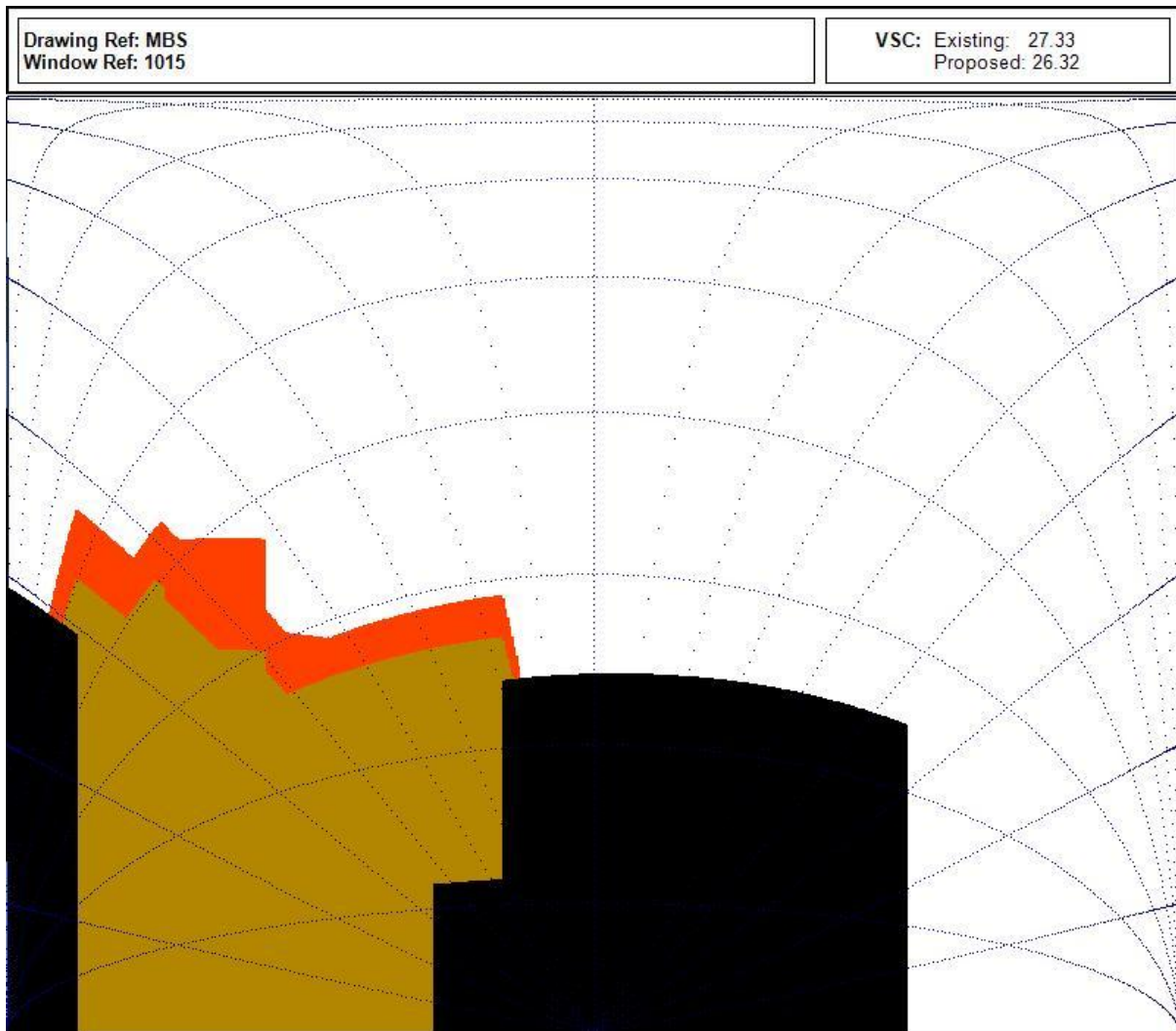

The green contour represents the existing building.
 The orange contour represents the proposed building.
 The black contour represents the surrounding buildings.

Surface 16 – 12 Doric Way - FF

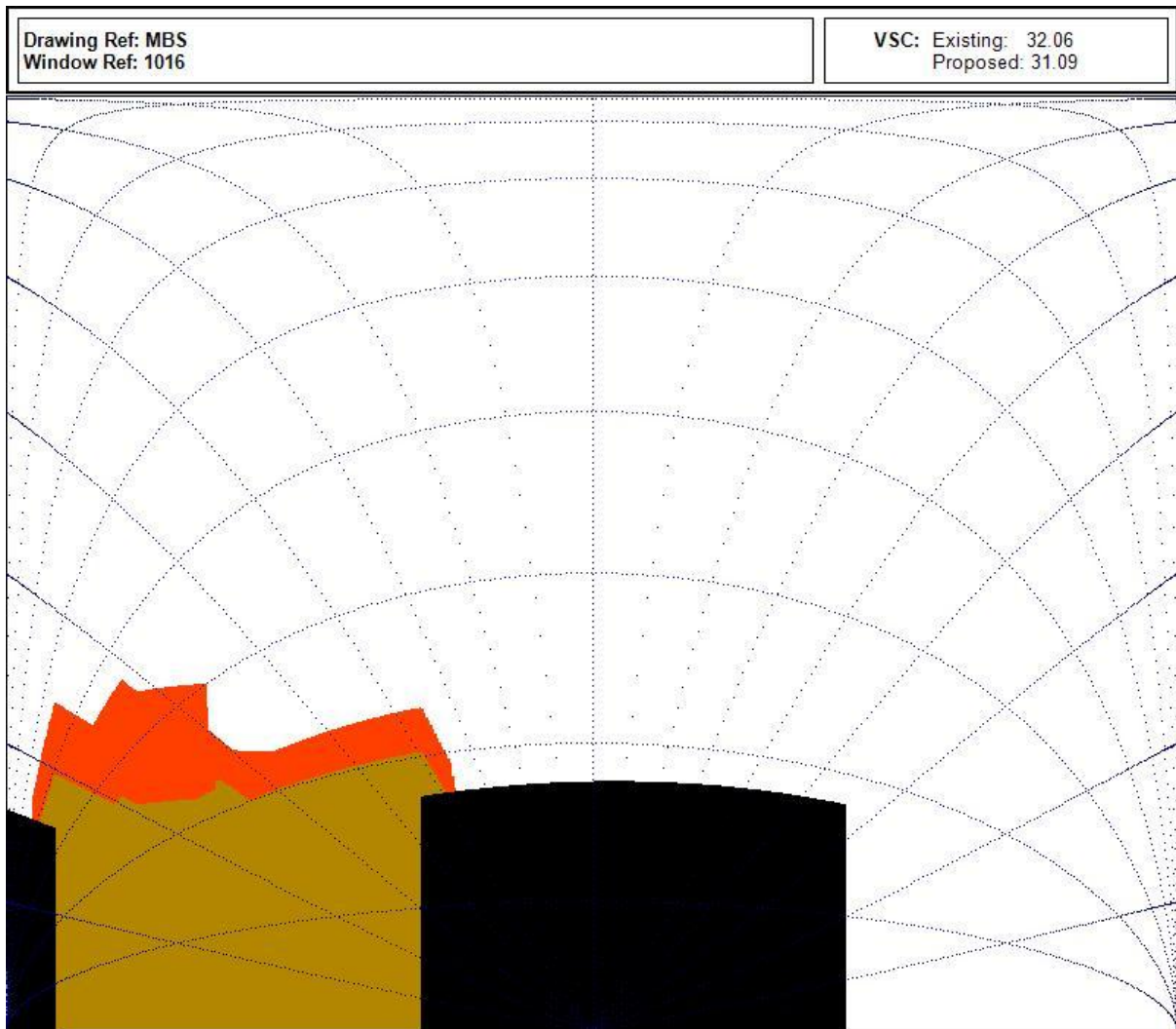

The green contour represents the existing building.
 The orange contour represents the proposed building.
 The black contour represents the surrounding buildings.

Surface 17 – 12 Doric Way - FF

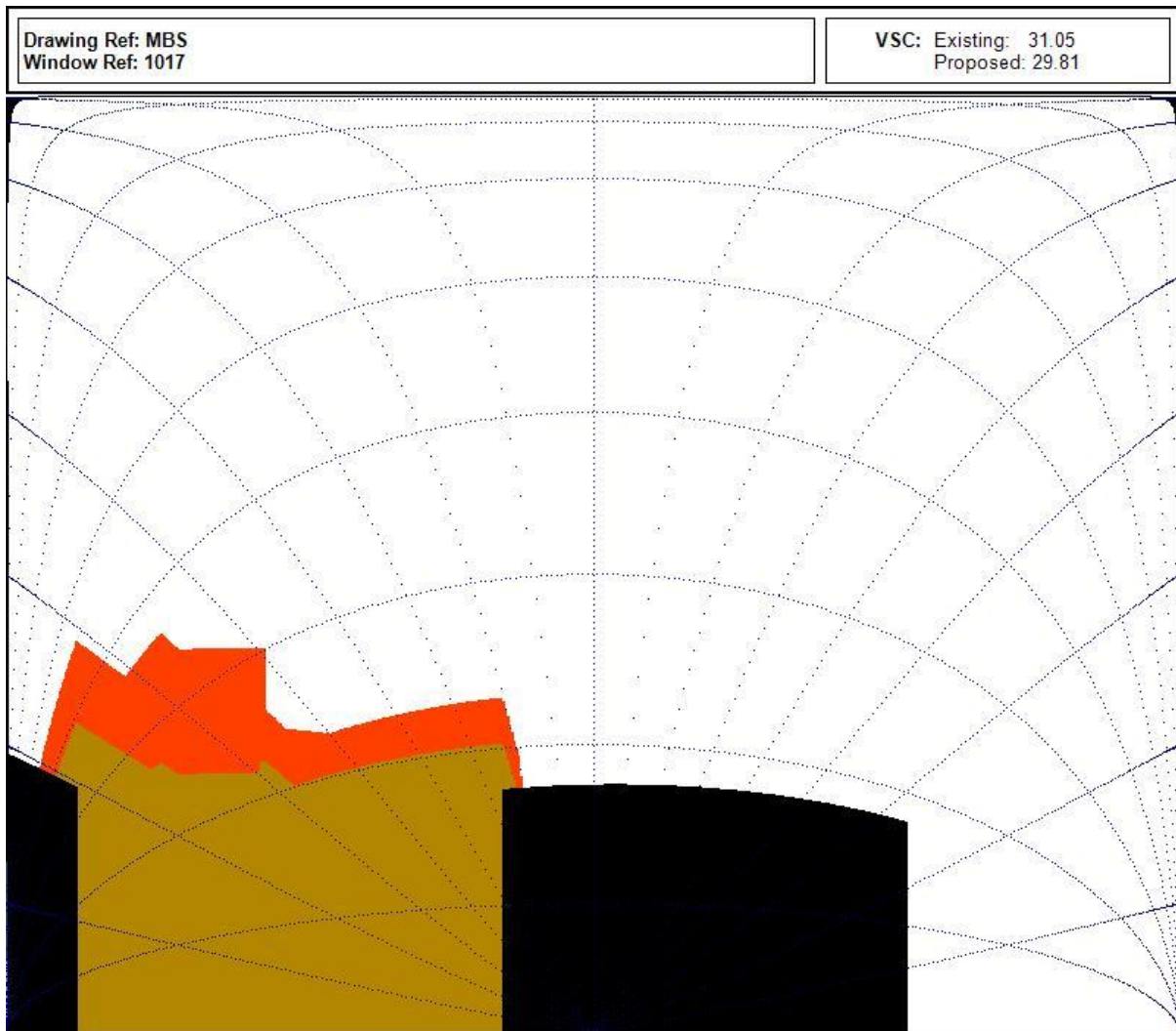

The green contour represents the existing building.
 The orange contour represents the proposed building.
 The black contour represents the surrounding buildings.

9.7. Sunlight results

Surface 4 – Ian Hamilton House - GF

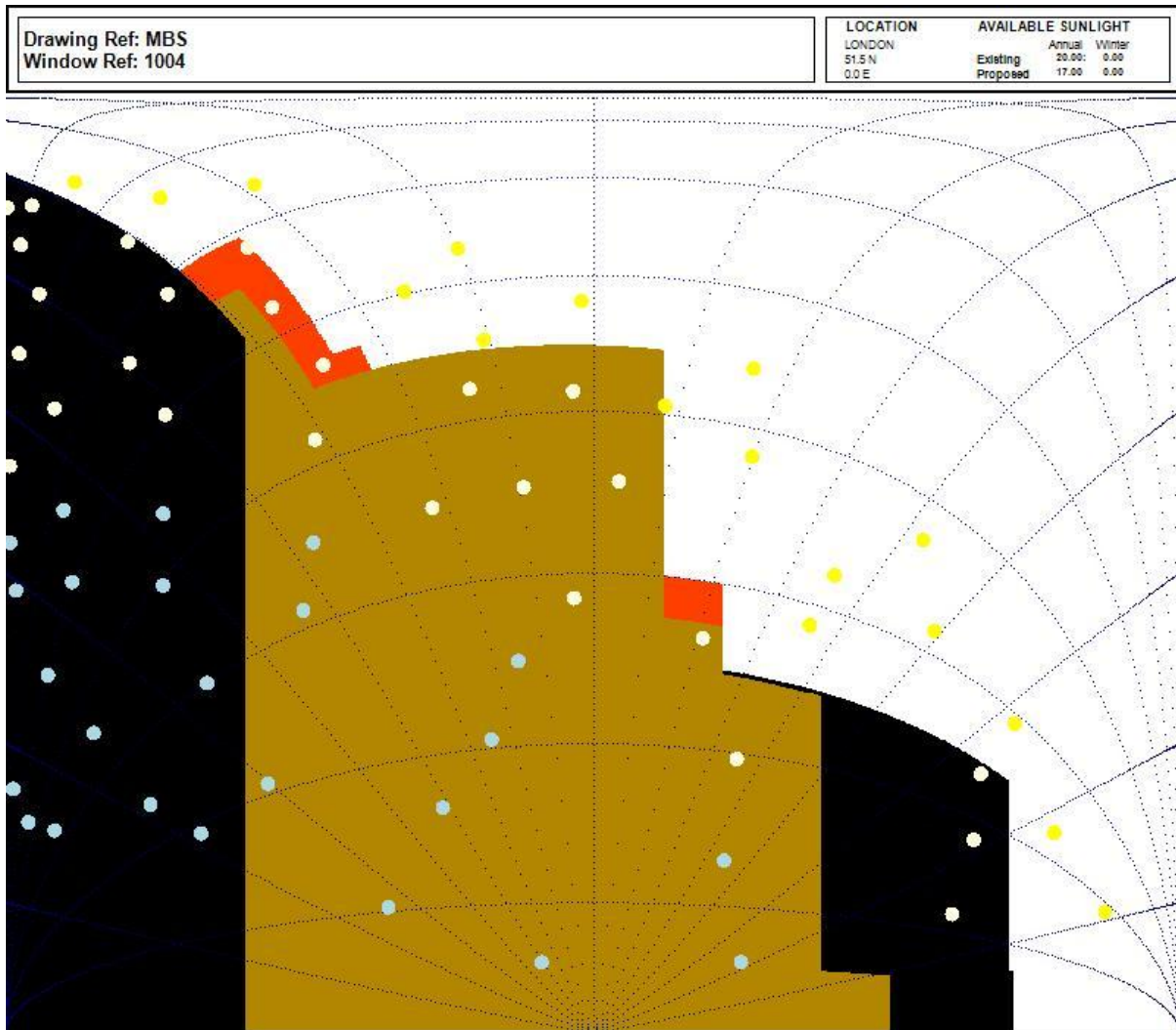

The green contour represents the existing building.
 The orange contour represents the proposed building.
 The black contour represents the surrounding buildings.

The yellow dot represents the available sunlight during the summer months (Summer).
 The blue dot represent the available sunlight during the winter months (Winter).
 The sum of the yellow and blue dots give the available sunlight for the whole year (Annual).

The white dot represents the sunlight blocked by buildings.

Surface 5 – Ian Hamilton House - GF

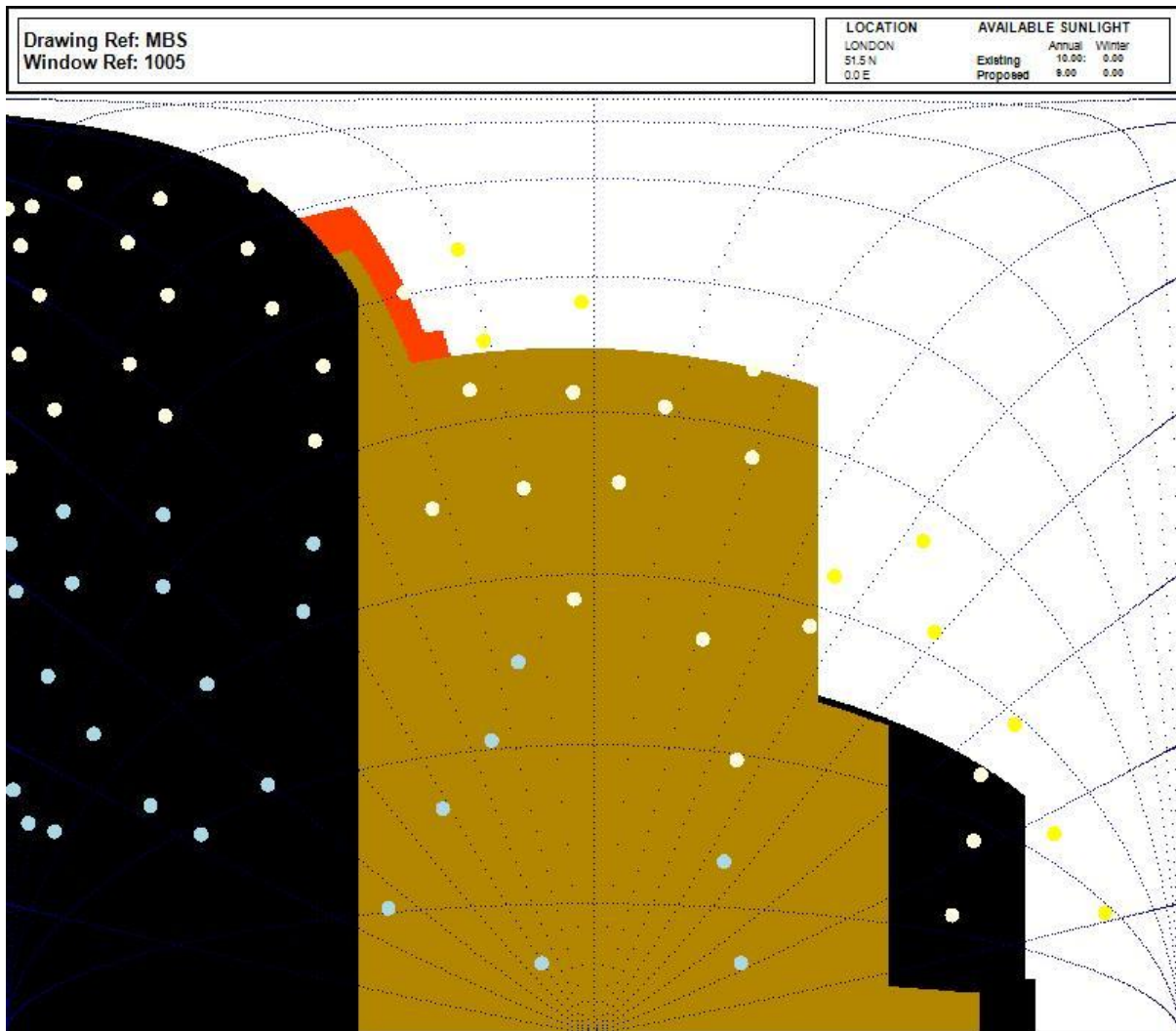

The green contour represents the existing building.
 The orange contour represents the proposed building.
 The black contour represents the surrounding buildings.

The yellow dot represents the available sunlight during the summer months (Summer).
 The blue dot represent the available sunlight during the winter months (Winter).
 The sum of the yellow and blue dots give the available sunlight for the whole year (Annual).

The white dot represents the sunlight blocked by buildings.

Surface 6 – Ian Hamilton House - FF

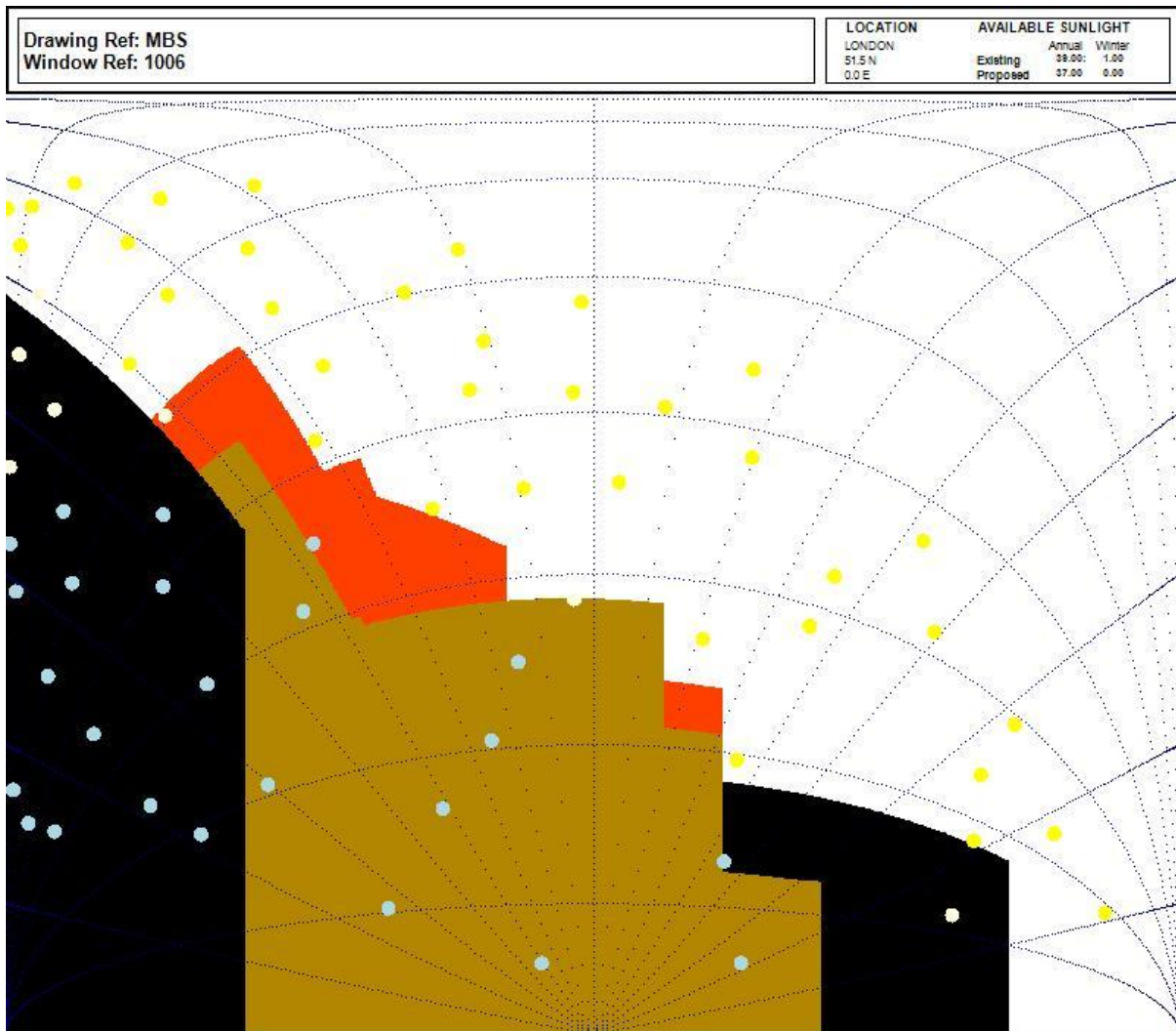

The green contour represents the existing building.
 The orange contour represents the proposed building.
 The black contour represents the surrounding buildings.

The yellow dot represents the available sunlight during the summer months (Summer).
 The blue dot represent the available sunlight during the winter months (Winter).
 The sum of the yellow and blue dots give the available sunlight for the whole year (Annual).

The white dot represents the sunlight blocked by buildings.

Surface 7 – Ian Hamilton House - FF

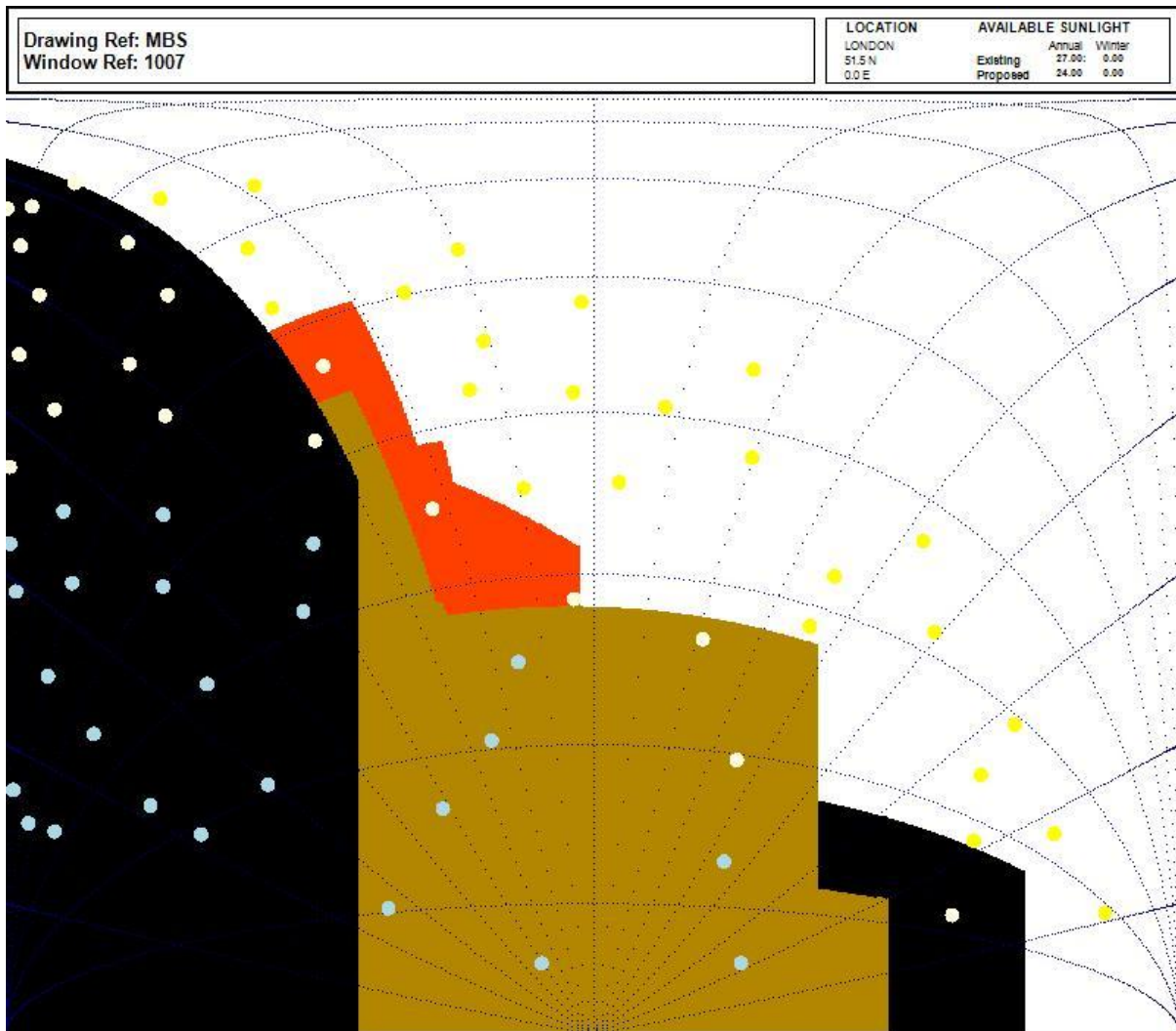

The green contour represents the existing building.
 The orange contour represents the proposed building.
 The black contour represents the surrounding buildings.

The yellow dot represents the available sunlight during the summer months (Summer).
 The blue dot represent the available sunlight during the winter months (Winter).
 The sum of the yellow and blue dots give the available sunlight for the whole year (Annual).

The white dot represents the sunlight blocked by buildings.

Surface 8 – Ian Hamilton House - SF

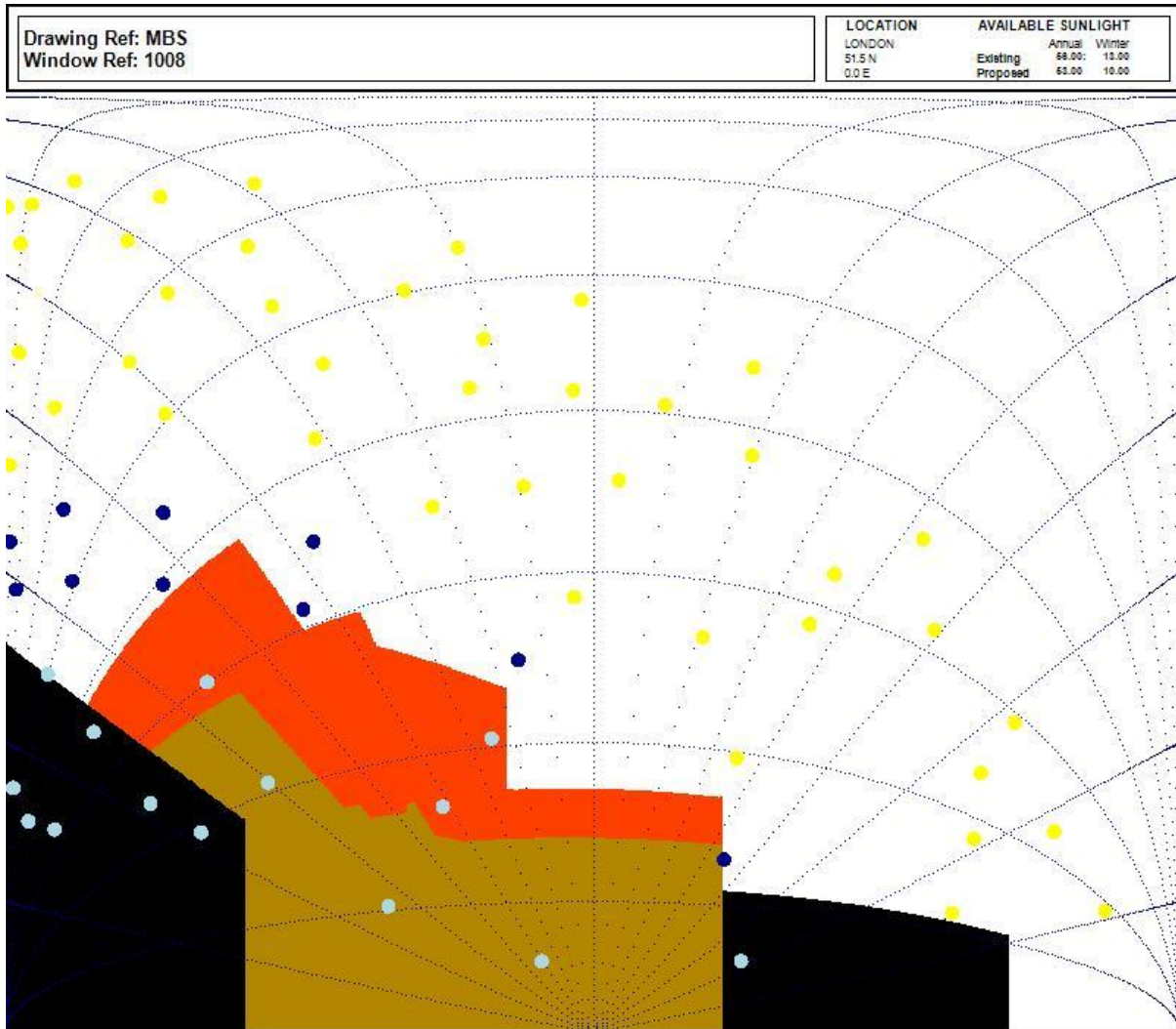

The green contour represents the existing building.
 The orange contour represents the proposed building.
 The black contour represents the surrounding buildings.

The yellow dot represents the available sunlight during the summer months (Summer).
 The blue dot represent the available sunlight during the winter months (Winter).
 The sum of the yellow and blue dots give the available sunlight for the whole year (Annual).

The white dot represents the sunlight blocked by buildings.

Surface 9 – Ian Hamilton House - SF

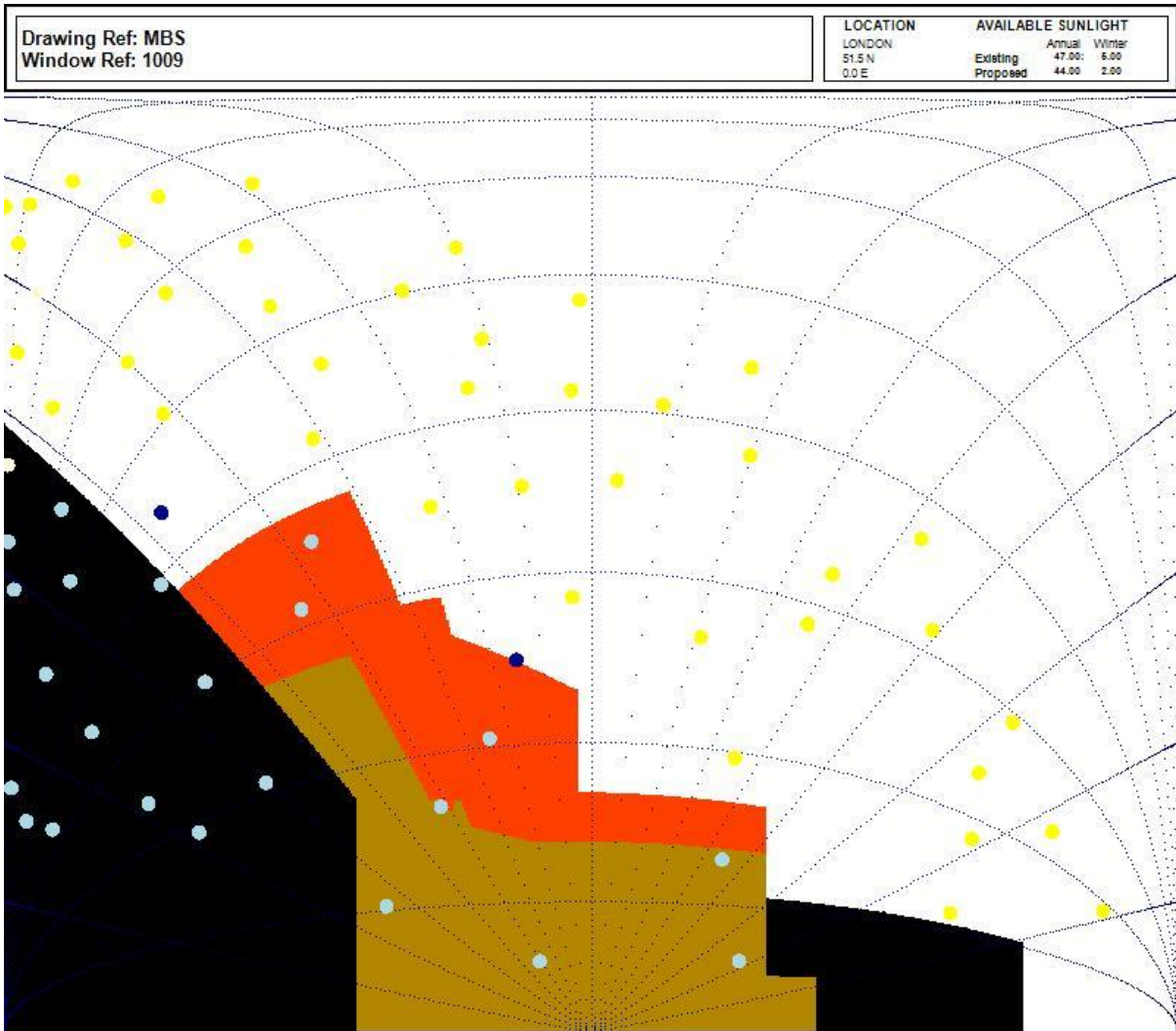

The green contour represents the existing building.
 The orange contour represents the proposed building.
 The black contour represents the surrounding buildings.

The yellow dot represents the available sunlight during the summer months (Summer).
 The blue dot represent the available sunlight during the winter months (Winter).
 The sum of the yellow and blue dots give the available sunlight for the whole year (Annual).

The white dot represents the sunlight blocked by buildings.

Surface 10 – 10 Doric Way - GF

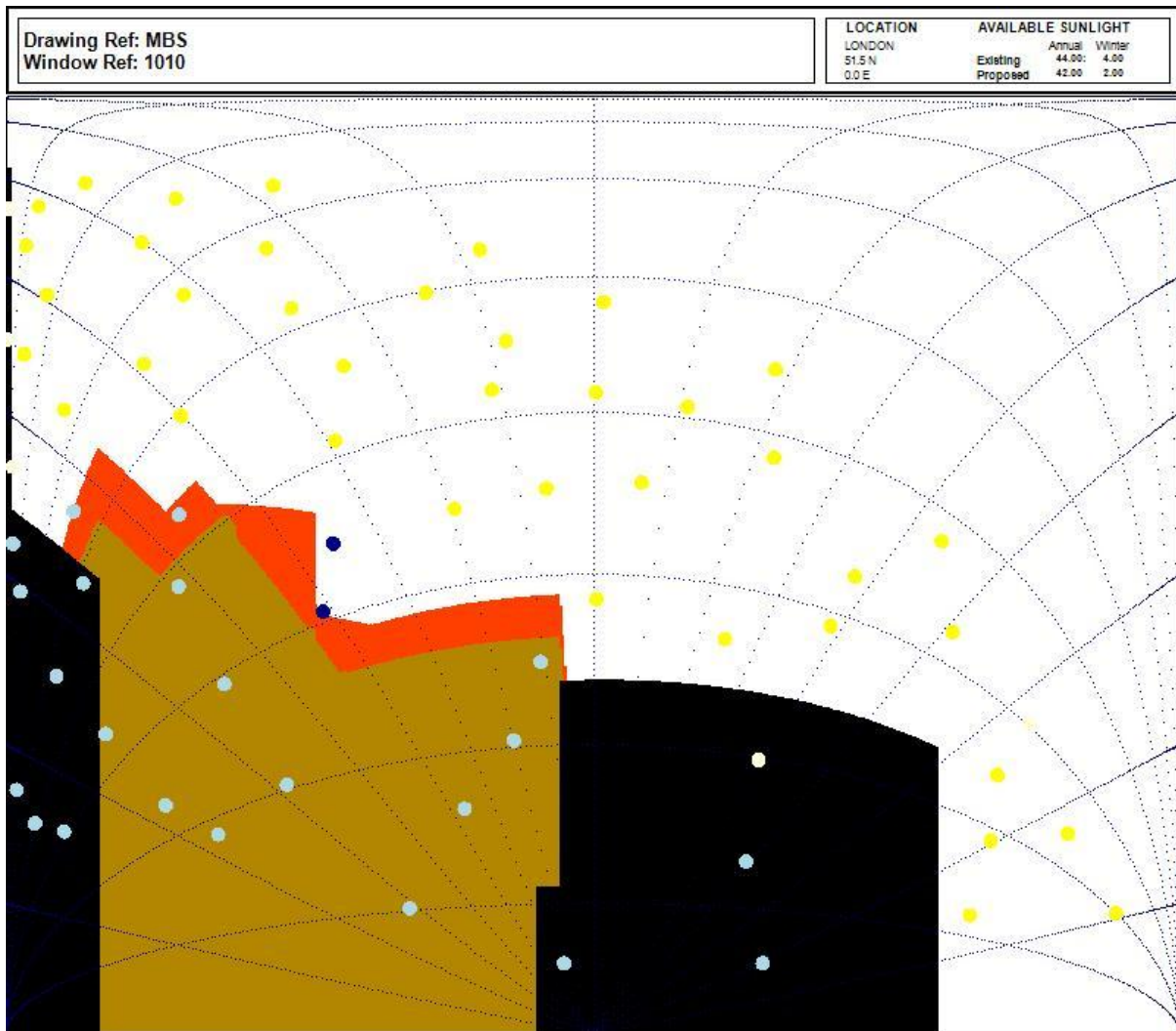

The green contour represents the existing building.
 The orange contour represents the proposed building.
 The black contour represents the surrounding buildings.

The yellow dot represents the available sunlight during the summer months (Summer).
 The blue dot represent the available sunlight during the winter months (Winter).
 The sum of the yellow and blue dots give the available sunlight for the whole year (Annual).

The white dot represents the sunlight blocked by buildings.

Surface 11 – 10 Doric Way - GF

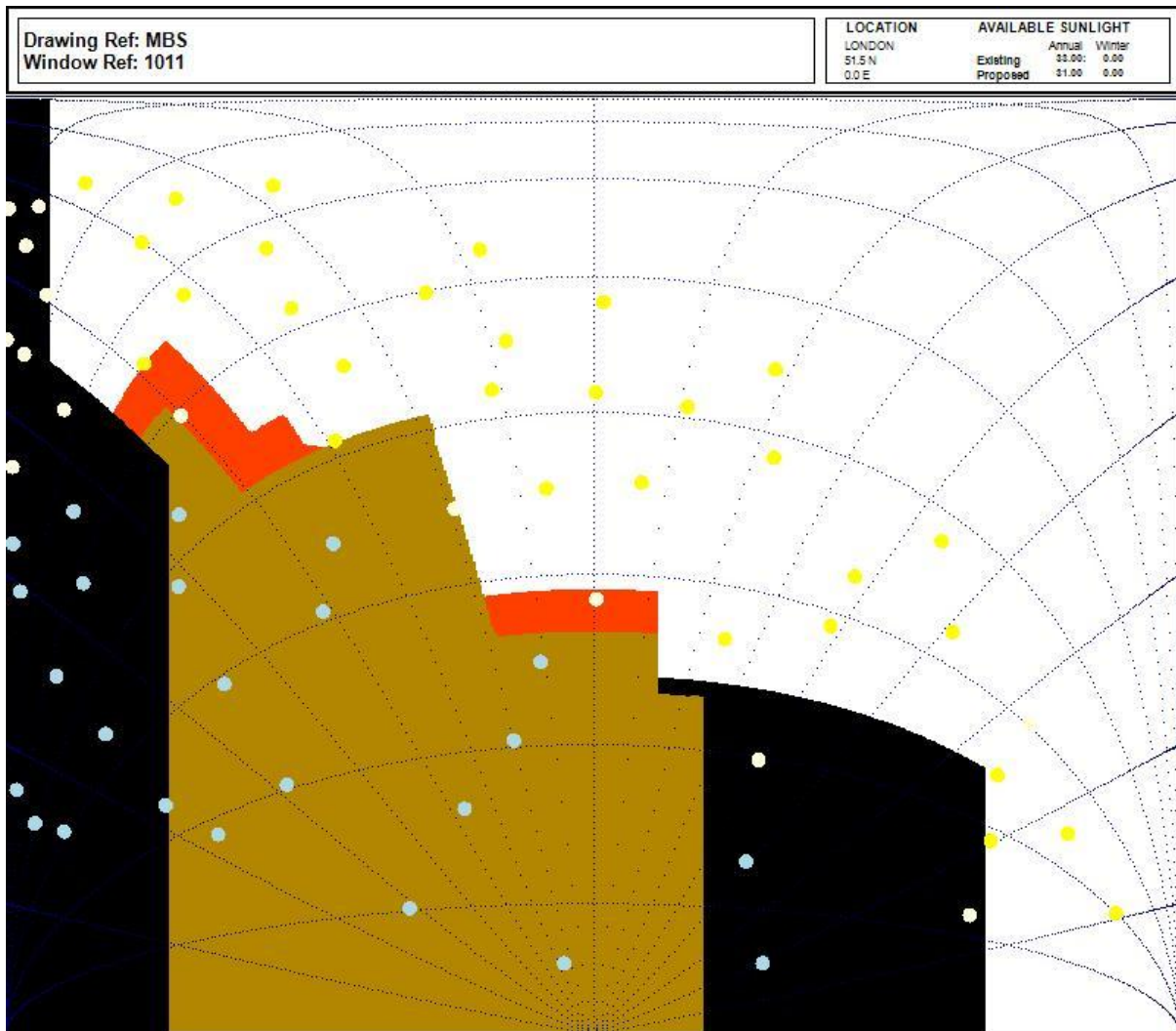

The green contour represents the existing building.
 The orange contour represents the proposed building.
 The black contour represents the surrounding buildings.

The yellow dot represents the available sunlight during the summer months (Summer).
 The blue dot represent the available sunlight during the winter months (Winter).
 The sum of the yellow and blue dots give the available sunlight for the whole year (Annual).

The white dot represents the sunlight blocked by buildings.

Surface 12 – 10 Doric Way - FF

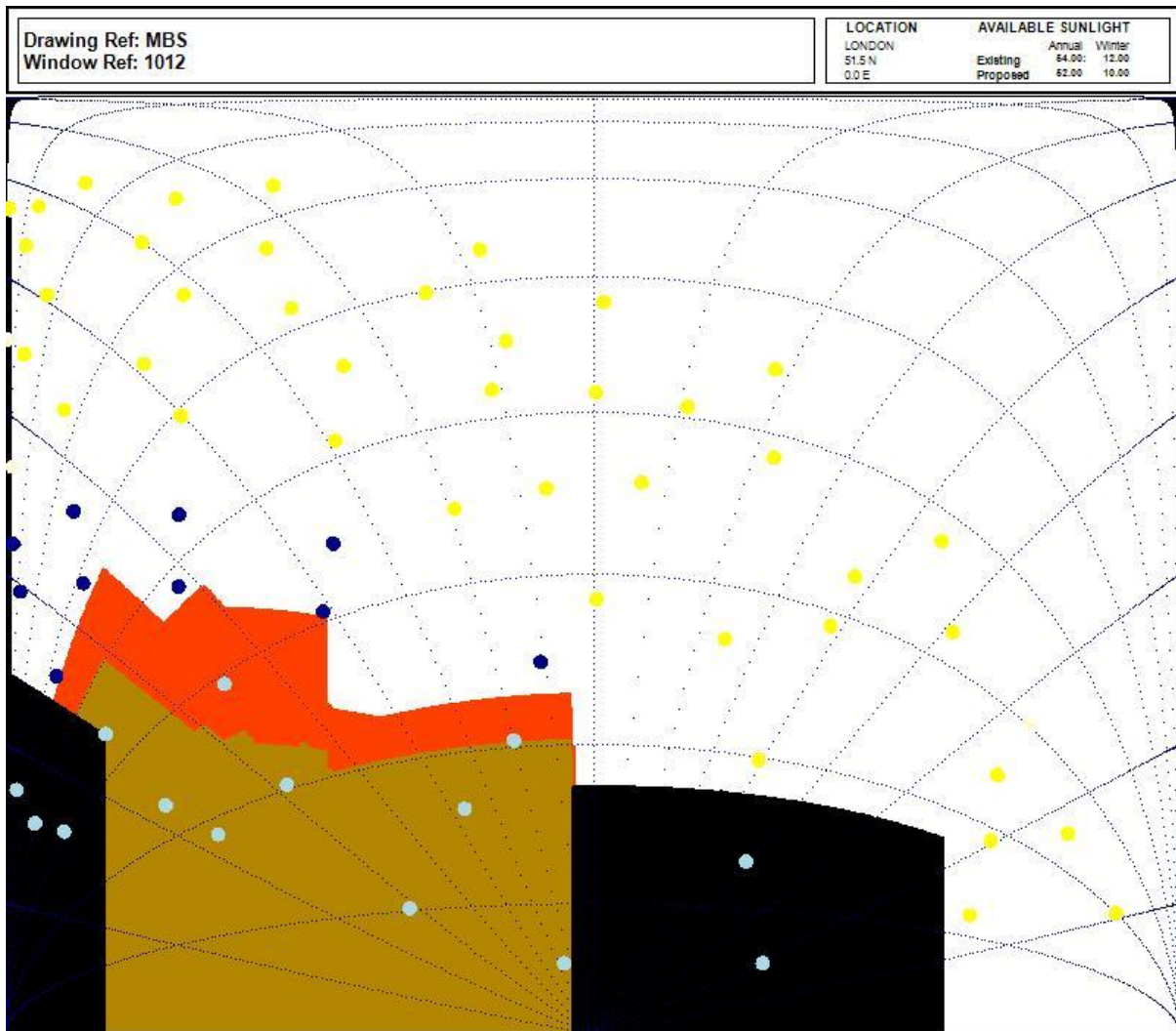

The green contour represents the existing building.
 The orange contour represents the proposed building.
 The black contour represents the surrounding buildings.

The yellow dot represents the available sunlight during the summer months (Summer).
 The blue dot represent the available sunlight during the winter months (Winter).
 The sum of the yellow and blue dots give the available sunlight for the whole year (Annual).

The white dot represents the sunlight blocked by buildings.

Surface 13 – 10 Doric Way - FF

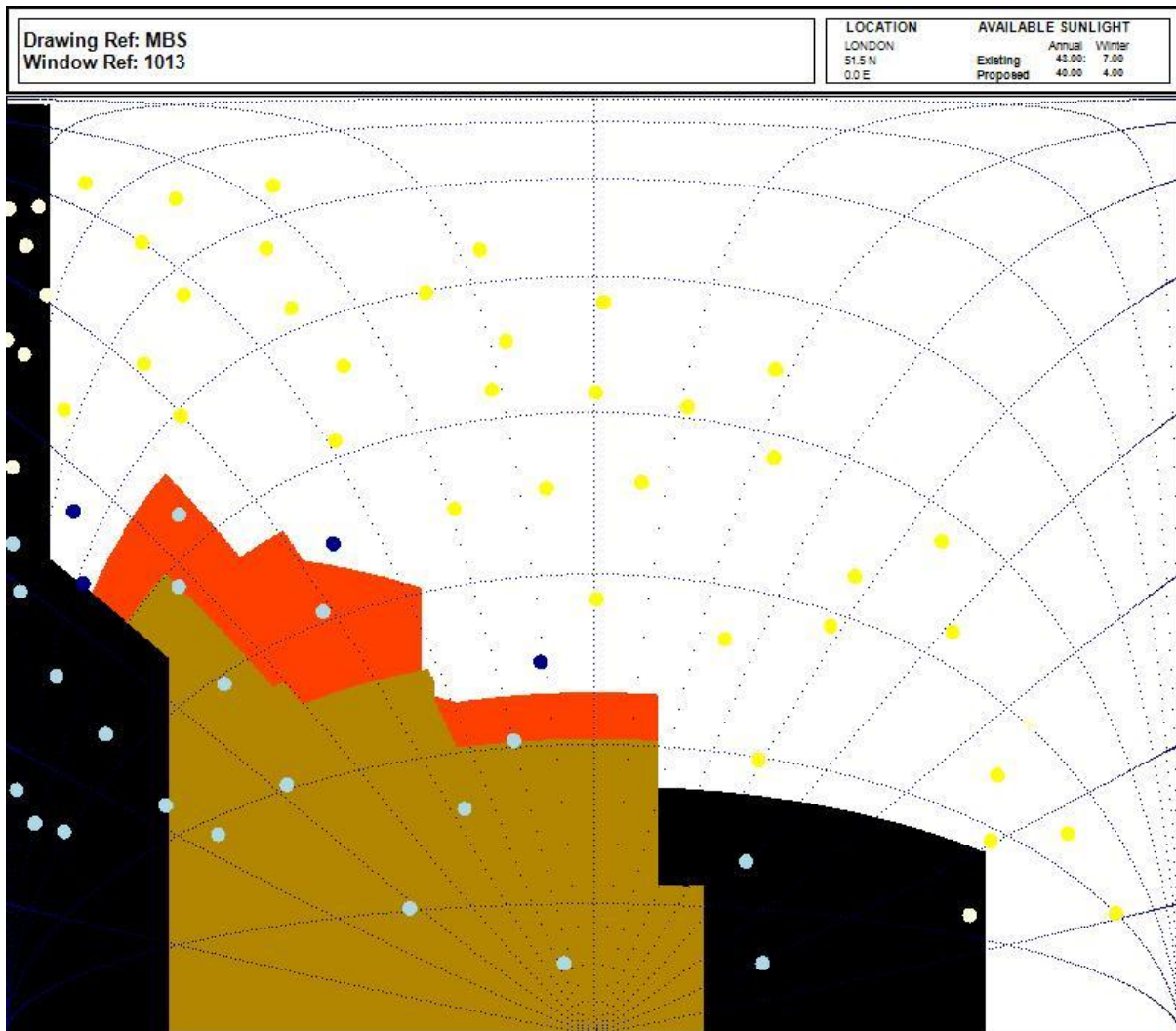

The green contour represents the existing building. N/A
 The orange contour represents the proposed building.
 The black contour represents the surrounding buildings.

The yellow dot represents the available sunlight during the summer months (Summer).
 The blue dot represent the available sunlight during the winter months (Winter).
 The sum of the yellow and blue dots give the available sunlight for the whole year (Annual).

The white dot represents the sunlight blocked by buildings.

Surface 14 – 12 Doric Way - GF

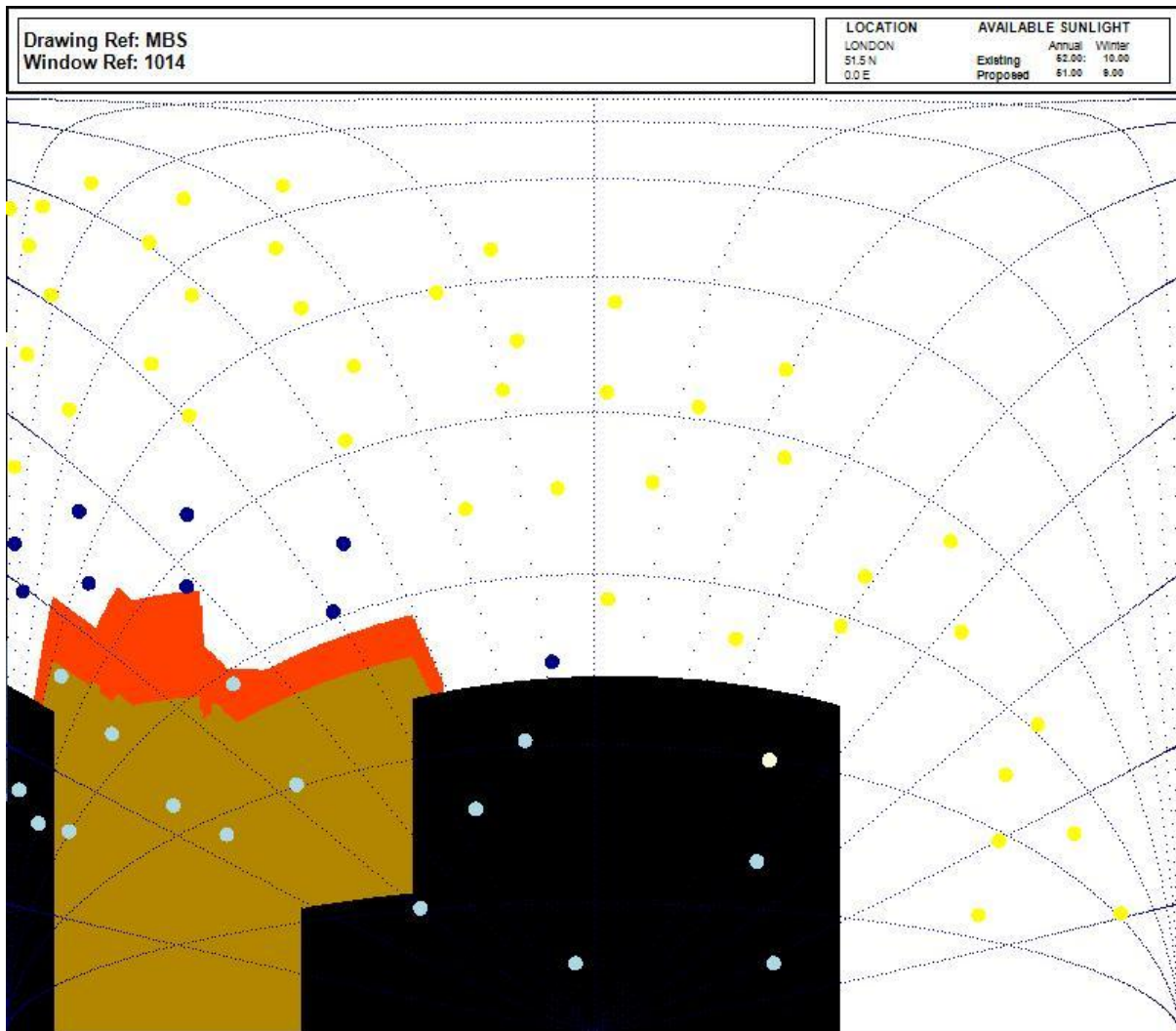

The green contour represents the existing building.
 The orange contour represents the proposed building.
 The black contour represents the surrounding buildings.

The yellow dot represents the available sunlight during the summer months (Summer).
 The blue dot represent the available sunlight during the winter months (Winter).
 The sum of the yellow and blue dots give the available sunlight for the whole year (Annual).

The white dot represents the sunlight blocked by buildings.

Surface 15 – 12 Doric Way - GF

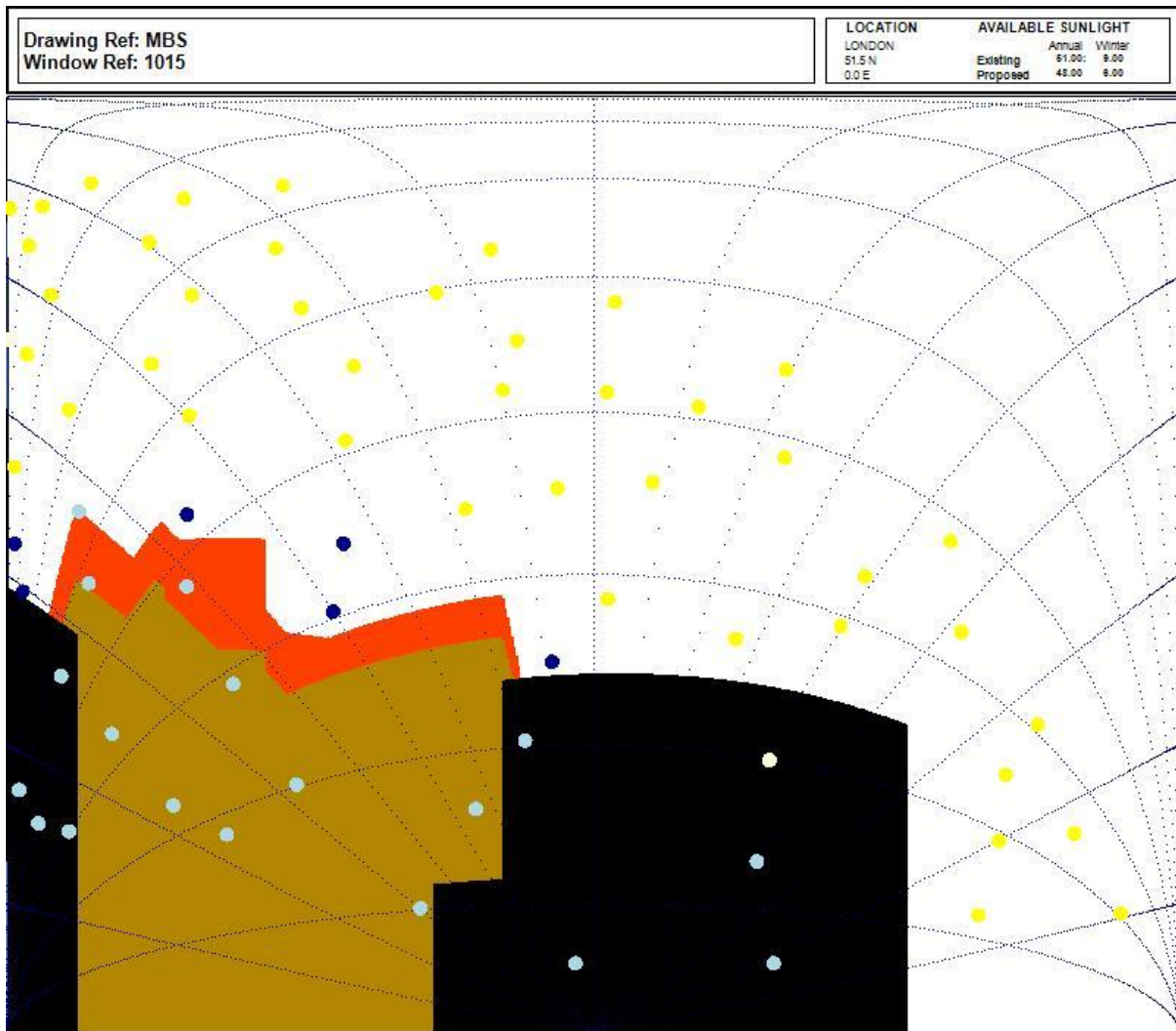

The green contour represents the existing building.
 The orange contour represents the proposed building.
 The black contour represents the surrounding buildings.

The yellow dot represents the available sunlight during the summer months (Summer).
 The blue dot represent the available sunlight during the winter months (Winter).
 The sum of the yellow and blue dots give the available sunlight for the whole year (Annual).

The white dot represents the sunlight blocked by buildings.

Surface 16 – 12 Doric Way - FF

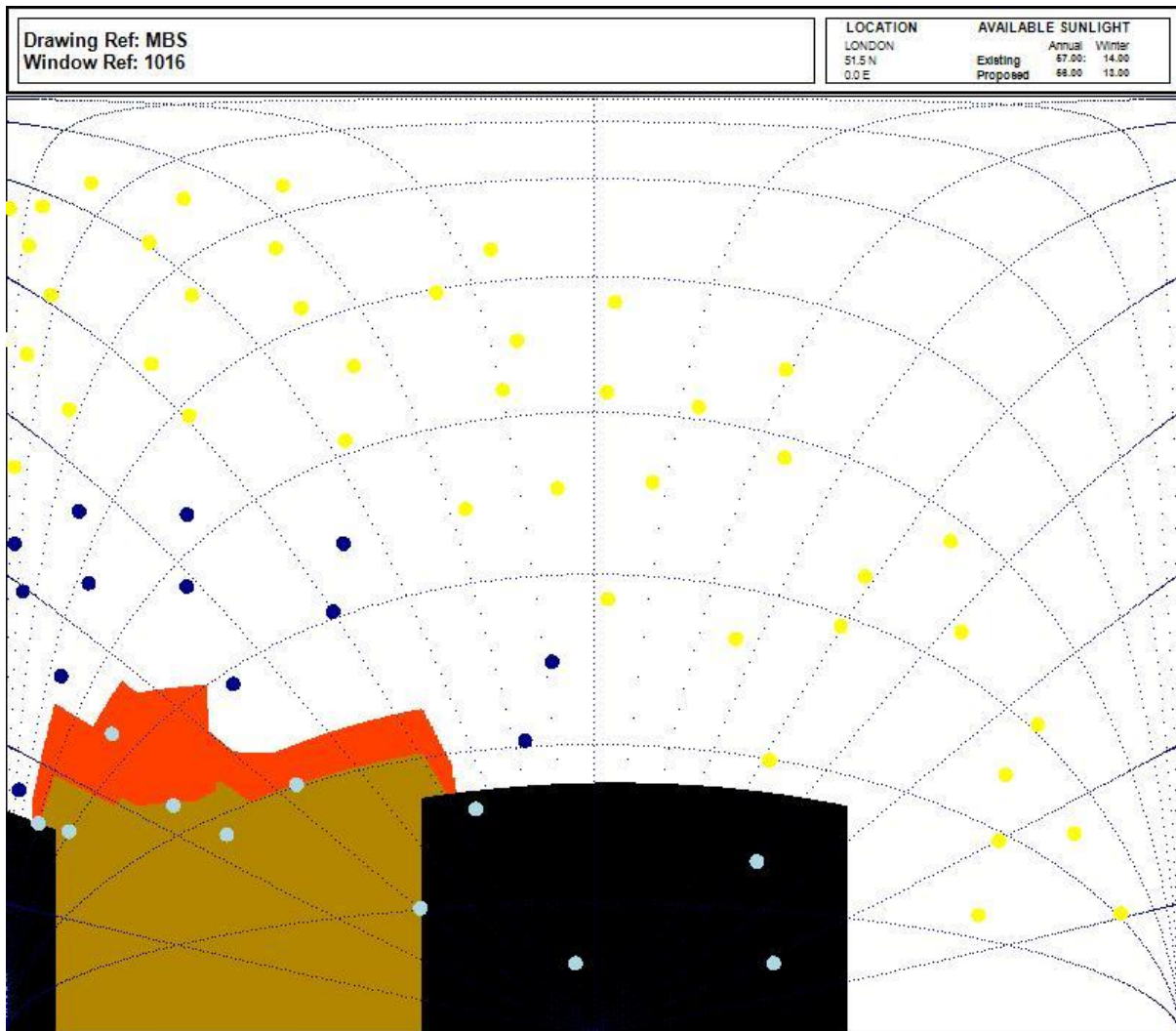

The green contour represents the existing building.
 The orange contour represents the proposed building.
 The black contour represents the surrounding buildings.

The yellow dot represents the available sunlight during the summer months (Summer).
 The blue dot represent the available sunlight during the winter months (Winter).
 The sum of the yellow and blue dots give the available sunlight for the whole year (Annual).

The white dot represents the sunlight blocked by buildings.

Surface 17 – 12 Doric Way - FF

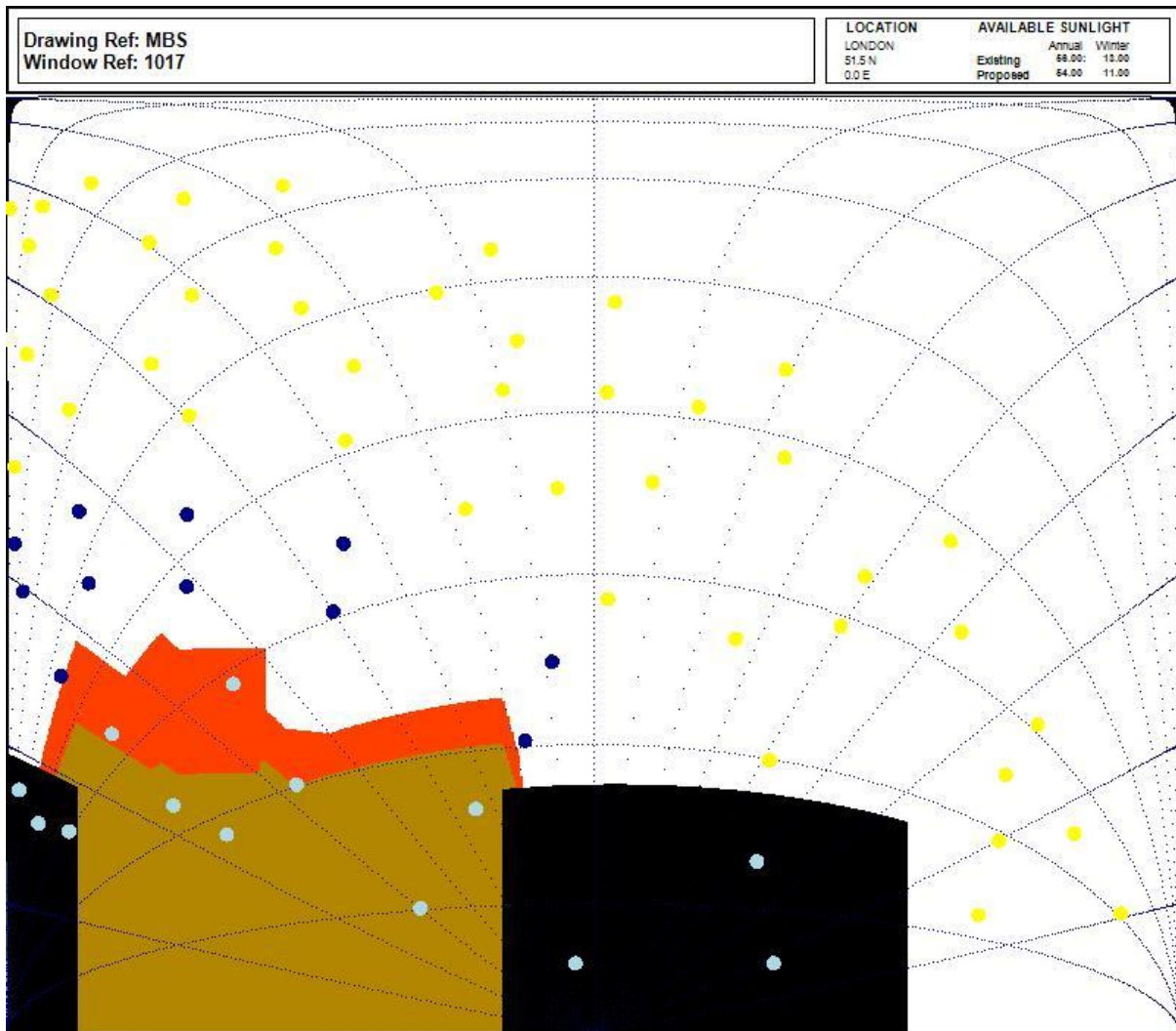

The green contour represents the existing building.
 The orange contour represents the proposed building.
 The black contour represents the surrounding buildings.

The yellow dot represents the available sunlight during the summer months (Summer).
 The blue dot represent the available sunlight during the winter months (Winter).
 The sum of the yellow and blue dots give the available sunlight for the whole year (Annual).

The white dot represents the sunlight blocked by buildings.

9.8. Overshadowing results and pictures (21st March)

Amenity 1 – 10 Doric Way - Garden

The results are expressed as a percentage of area receiving direct sunlight on 21st March.

Existing

Month	04:00	05:00	06:00	07:00	08:00	09:00	10:00	11:00	12:00	13:00	14:00	15:00	16:00	17:00	18:00	19:00	20:00
Jan						0.00	0.00	0.00	0.00	0.00	0.00	0.00	0.00				
Feb					0.00	0.00	0.00	0.00	0.00	0.00	0.00	0.00	0.00	0.00			
Mar				0.00	0.00	0.00	0.00	0.00	3.60	5.20	15.60	0.00	0.00	0.00	0.00		
Apr			0.00	0.00	0.00	0.00	26.60	52.70	53.20	55.10	64.00	58.80	12.80	0.00	0.70	0.00	
May		0.00	0.00	0.00	0.00	3.10	47.40	76.60	73.00	77.40	80.30	73.30	64.70	21.60	27.00	0.00	
Jun	0.00	0.00	0.00	0.00	0.00	0.60	43.10	79.90	78.20	82.10	83.00	76.30	67.80	50.70	36.70	1.60	0.00
Jul		0.00	0.00	0.00	0.00	0.00	40.60	77.10	73.70	76.60	80.00	74.80	66.40	32.90	31.40	0.00	
Aug			0.00	0.00	0.00	0.00	24.30	53.50	54.20	55.50	64.50	59.80	19.60	0.00	0.70	0.00	
Sep			0.00	0.00	0.00	0.00	0.00	2.20	3.80	11.30	13.40	0.00	0.00	0.00			
Oct				0.00	0.00	0.00	0.00	0.00	0.00	0.00	0.00	0.00	0.00				
Nov					0.00	0.00	0.00	0.00	0.00	0.00	0.00	0.00					
Dec						0.00	0.00	0.00	0.00	0.00	0.00	0.00					

Proposed

Month	04:00	05:00	06:00	07:00	08:00	09:00	10:00	11:00	12:00	13:00	14:00	15:00	16:00	17:00	18:00	19:00	20:00
Jan						0.00	0.00	0.00	0.00	0.00	0.00	0.00	0.00				
Feb					0.00	0.00	0.00	0.00	0.00	0.00	0.00	0.00	0.00	0.00			
Mar				0.00	0.00	0.00	0.00	0.00	3.60	0.90	11.50	0.00	0.00	0.00	0.00		
Apr			0.00	0.00	0.00	0.00	26.60	52.70	53.20	55.10	64.00	58.60	12.80	0.00	0.70	0.00	
May		0.00	0.00	0.00	0.00	3.10	47.40	76.60	73.00	77.40	80.30	73.30	64.70	21.60	27.00	0.00	
Jun	0.00	0.00	0.00	0.00	0.00	0.60	43.10	79.90	78.20	82.10	83.00	76.30	67.80	50.70	36.70	1.60	0.00
Jul		0.00	0.00	0.00	0.00	0.00	40.60	77.10	73.70	76.60	80.00	74.80	66.40	32.90	31.40	0.00	
Aug			0.00	0.00	0.00	0.00	24.30	53.50	54.20	55.50	64.50	59.80	19.60	0.00	0.70	0.00	
Sep			0.00	0.00	0.00	0.00	0.00	2.20	3.80	6.60	2.20	0.00	0.00	0.00			
Oct				0.00	0.00	0.00	0.00	0.00	0.00	0.00	0.00	0.00	0.00				
Nov					0.00	0.00	0.00	0.00	0.00	0.00	0.00	0.00					
Dec						0.00	0.00	0.00	0.00	0.00	0.00	0.00					

Overshadowing assessment % of the amenity area receiving direct sunlight on 21 st March		
Existing	Proposed	Ratio
2.00	1.33	0.66

Amenity 2 – 12 Doric Way - Garden

The results are expressed as a percentage of area receiving direct sunlight on 21st March.

Existing

Month	04:00	05:00	06:00	07:00	08:00	09:00	10:00	11:00	12:00	13:00	14:00	15:00	16:00	17:00	18:00	19:00	20:00
Jan						0.00	0.00	0.00	0.00	0.00	0.00	0.00	0.00				
Feb					0.00	0.00	0.00	2.70	18.00	18.20	0.00	0.00	0.00	0.00			
Mar				0.00	0.00	0.00	45.90	70.50	71.60	71.10	58.20	0.00	0.00	0.20	0.00		
Apr			0.00	0.00	0.00	2.00	65.40	84.70	82.30	80.10	77.80	72.80	13.00	27.20	6.30	0.00	
May		0.00	0.00	0.00	4.40	27.10	71.50	89.10	86.90	85.00	83.50	77.50	68.10	54.20	35.10	0.00	
Jun	0.00	0.00	0.00	0.00	6.70	32.70	70.60	90.80	88.60	86.90	85.60	79.70	71.50	60.80	45.00	16.20	0.00
Jul		0.00	0.00	0.00	1.90	23.70	65.60	89.70	87.30	85.50	83.90	79.00	70.00	54.60	39.90	6.70	
Aug			0.00	0.00	0.00	1.50	61.90	85.00	82.50	80.30	78.10	73.60	19.70	26.70	9.80	0.00	
Sep			0.00	0.00	0.00	0.00	69.70	70.20	73.60	68.80	49.30	0.00	0.00	0.00			
Oct				0.00	0.00	0.00	0.00	7.20	16.60	0.00	0.00	0.00	0.00				
Nov					0.00	0.00	0.00	0.00	0.00	0.00	0.00	0.00					
Dec						0.00	0.00	0.00	0.00	0.00	0.00	0.00					

Proposed

Month	04:00	05:00	06:00	07:00	08:00	09:00	10:00	11:00	12:00	13:00	14:00	15:00	16:00	17:00	18:00	19:00	20:00
Jan						0.00	0.00	0.00	0.00	0.00	0.00	0.00	0.00				
Feb					0.00	0.00	0.00	2.70	0.00	1.40	0.00	0.00	0.00	0.00			
Mar				0.00	0.00	0.00	45.90	70.50	64.10	69.90	45.10	0.00	0.00	0.20	0.00		
Apr			0.00	0.00	0.00	2.00	65.40	84.70	82.30	80.10	77.80	72.80	13.00	27.20	6.30	0.00	
May		0.00	0.00	0.00	4.40	27.10	71.50	89.10	86.90	85.00	83.50	77.50	68.10	54.20	35.10	0.00	
Jun	0.00	0.00	0.00	0.00	6.70	32.70	70.60	90.80	88.60	86.90	85.60	79.70	71.50	60.80	45.00	16.20	0.00
Jul		0.00	0.00	0.00	1.90	23.70	65.60	89.70	87.30	85.50	83.90	79.00	70.00	54.60	39.90	6.70	
Aug			0.00	0.00	0.00	1.50	61.90	85.00	82.50	80.30	78.10	73.60	19.70	26.70	9.80	0.00	
Sep			0.00	0.00	0.00	0.00	69.70	70.20	63.80	68.80	37.10	0.00	0.00	0.00			
Oct				0.00	0.00	0.00	0.00	1.10	0.00	0.00	0.00	0.00	0.00				
Nov					0.00	0.00	0.00	0.00	0.00	0.00	0.00	0.00					
Dec						0.00	0.00	0.00	0.00	0.00	0.00	0.00					

Overshadowing assessment % of the amenity area receiving direct sunlight on 21 st March		
Existing	Proposed	Ratio
26.46	24.64	0.93

Amenity 3 – 40 Eversholt Street - Garden

The results are expressed as a percentage of area receiving direct sunlight on 21st March.

Existing

Month	04:00	05:00	06:00	07:00	08:00	09:00	10:00	11:00	12:00	13:00	14:00	15:00	16:00	17:00	18:00	19:00	20:00
Jan						0.00	0.00	0.00	0.00	0.00	0.00	0.00	0.00				
Feb					0.00	0.00	0.00	0.00	0.00	0.00	0.00	0.00	0.00	0.00			
Mar				0.00	0.00	0.00	0.00	0.20	2.00	0.00	0.00	0.00	0.00	0.00	0.00		
Apr			0.00	0.00	0.00	33.70	36.80	42.40	33.00	15.20	10.30	0.00	0.00	0.00	0.00	0.00	
May		0.00	0.00	0.00	1.80	64.50	71.20	76.40	58.20	39.60	29.60	14.90	0.00	0.00	2.70	0.00	
Jun	0.00	0.00	0.00	0.00	2.10	72.40	80.30	90.40	66.50	48.70	38.10	25.10	7.00	0.00	14.60	0.00	0.00
Jul		0.00	0.00	0.00	0.00	65.60	70.20	79.20	62.50	42.80	31.20	18.70	0.00	0.00	3.40	0.00	
Aug			0.00	0.00	0.00	34.80	37.10	43.40	34.60	16.30	11.50	0.00	0.00	0.00	0.00	0.00	
Sep			0.00	0.00	0.00	0.00	0.00	2.70	0.00	0.00	0.00	0.00	0.00	0.00			
Oct				0.00	0.00	0.00	0.00	0.00	0.00	0.00	0.00	0.00	0.00				
Nov					0.00	0.00	0.00	0.00	0.00	0.00	0.00	0.00					
Dec						0.00	0.00	0.00	0.00	0.00	0.00	0.00					

Proposed

Month	04:00	05:00	06:00	07:00	08:00	09:00	10:00	11:00	12:00	13:00	14:00	15:00	16:00	17:00	18:00	19:00	20:00
Jan						0.00	0.00	0.00	0.00	0.00	0.00	0.00	0.00				
Feb					0.00	0.00	0.00	0.00	0.00	0.00	0.00	0.00	0.00	0.00			
Mar				0.00	0.00	0.00	0.10	0.00	0.00	0.00	0.00	0.00	0.00	0.00	0.00		
Apr		0.00	0.00	0.00	0.00	33.60	36.80	41.90	29.70	15.20	6.50	0.00	0.00	0.00	0.00		
May		0.00	0.00	0.00	4.20	64.40	71.40	76.10	57.60	39.20	29.40	14.40	0.00	0.00	2.60	0.00	
Jun	0.00	0.00	0.00	0.00	4.70	72.40	80.50	89.90	65.90	48.20	37.90	24.70	6.40	0.00	14.70	0.00	0.00
Jul		0.00	0.00	0.00	0.00	65.50	70.30	78.80	61.90	42.30	31.10	18.20	0.00	0.00	3.50	0.00	
Aug			0.00	0.00	0.00	34.60	37.10	43.00	31.60	15.70	8.40	0.00	0.00	0.00	0.00	0.00	
Sep			0.00	0.00	0.00	0.00	0.00	0.00	0.00	0.00	0.00	0.00	0.00	0.00			
Oct				0.00	0.00	0.00	0.00	0.00	0.00	0.00	0.00	0.00	0.00				
Nov					0.00	0.00	0.00	0.00	0.00	0.00	0.00	0.00					
Dec						0.00	0.00	0.00	0.00	0.00	0.00	0.00					

Overshadowing assessment		
% of the amenity area receiving direct sunlight on 21 st March		
Existing	Proposed	Ratio
0.18	0	/

Suncast image:

View time = 21 Mar 07:00
 Site Latitude = 51.48
 Longitude diff. = -0.45
 Model Bearing = 0.00
 Sun: azi = 100.16 alt = 7.48
 Eye: azi = 180.00 alt = 70.00

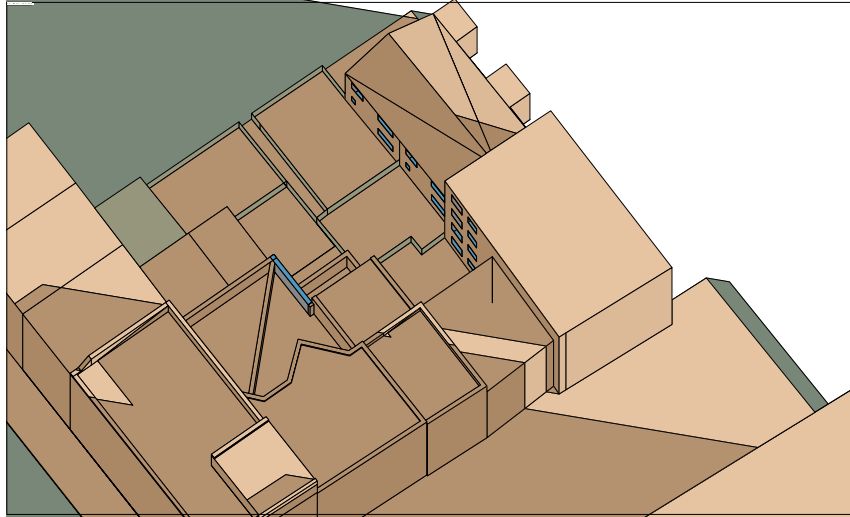
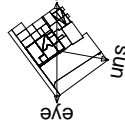

Existing

Suncast image:

View time = 21 Mar 07:00
 Site Latitude = 51.48
 Longitude diff. = -0.45
 Model Bearing = 0.00
 Sun: azi = 100.16 alt = 7.48
 Eye: azi = 180.00 alt = 70.00

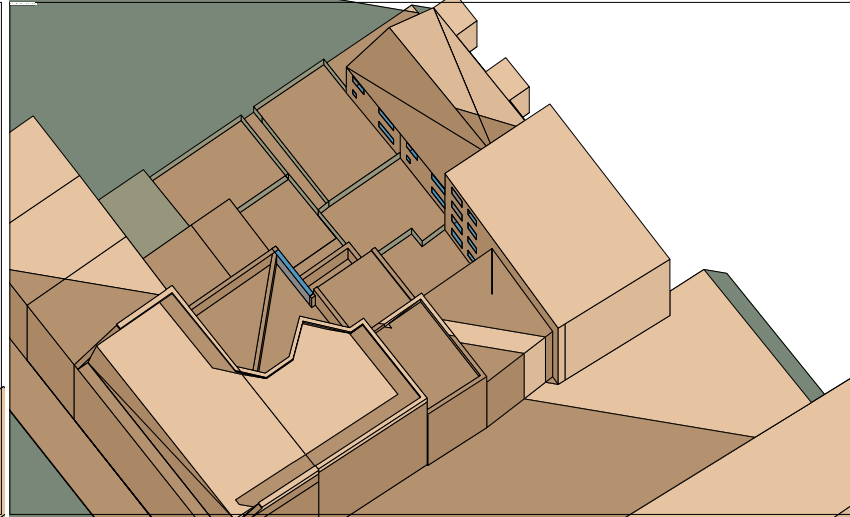
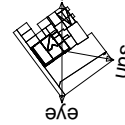

Proposed

Suncast image:

View time = 21 Mar 08:00
 Site Latitude = 51.48
 Longitude diff. = -0.45
 Model Bearing = 0.00
 Sun: azi = 112.48 alt = 16.43
 Eye: azi = 180.00 alt = 70.00

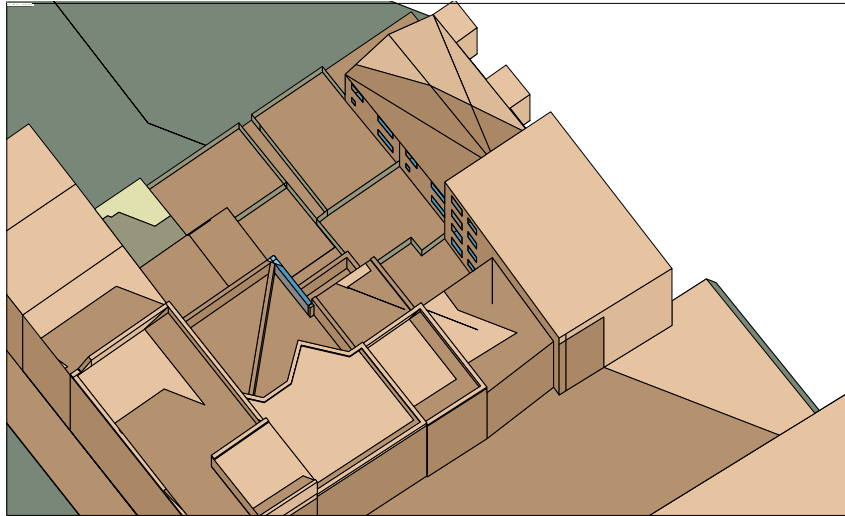
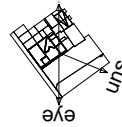

Existing

Suncast image:

View time = 21 Mar 08:00
 Site Latitude = 51.48
 Longitude diff. = -0.45
 Model Bearing = 0.00
 Sun: azi = 112.48 alt = 16.43
 Eye: azi = 180.00 alt = 70.00

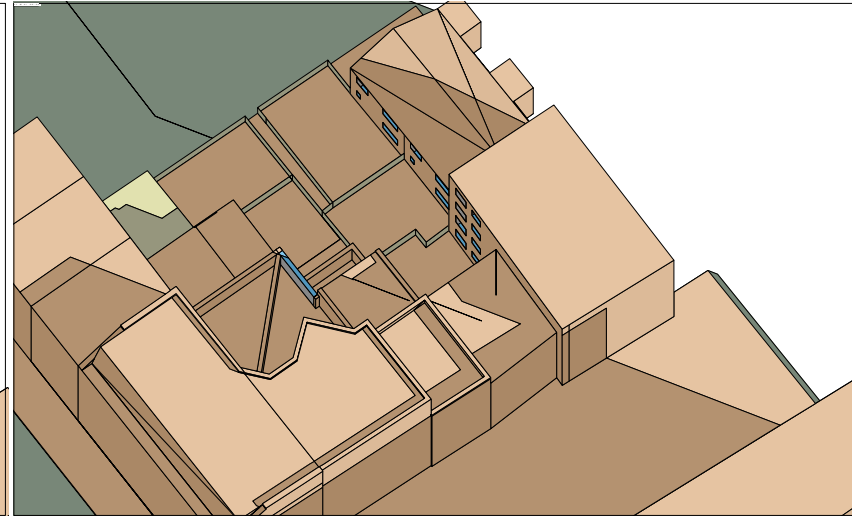
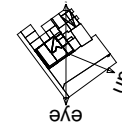

Proposed

Suncast image:

View time = 21 Mar 09:00
 Site Latitude = 51.48
 Longitude diff. = -0.45
 Model Bearing = 0.00
 Sun: azi = 125.95 alt = 24.58
 Eye: azi = 180.00 alt = 70.00

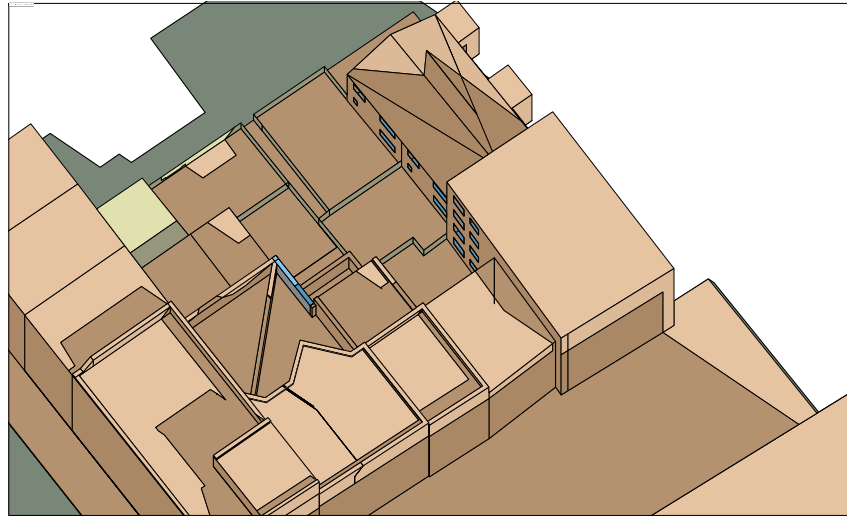
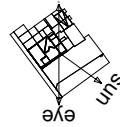

Existing

Suncast image:

View time = 21 Mar 09:00
 Site Latitude = 51.48
 Longitude diff. = -0.45
 Model Bearing = 0.00
 Sun: azi = 125.95 alt = 24.58
 Eye: azi = 180.00 alt = 70.00

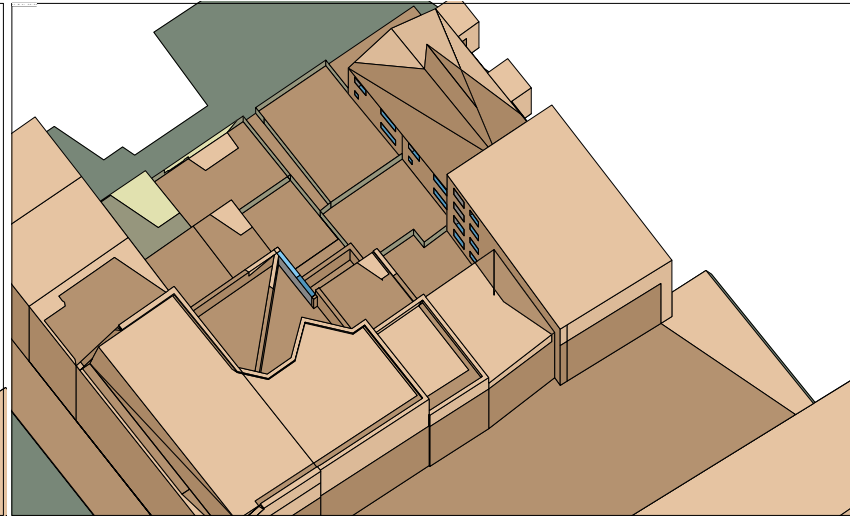
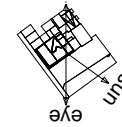

Proposed

Suncast image:

View time = 21 Mar 10:00
 Site Latitude = 51.48
 Longitude diff. = -0.45
 Model Bearing = 0.00
 Sun: azi = 141.13 alt = 31.35
 Eye: azi = 180.00 alt = 70.00

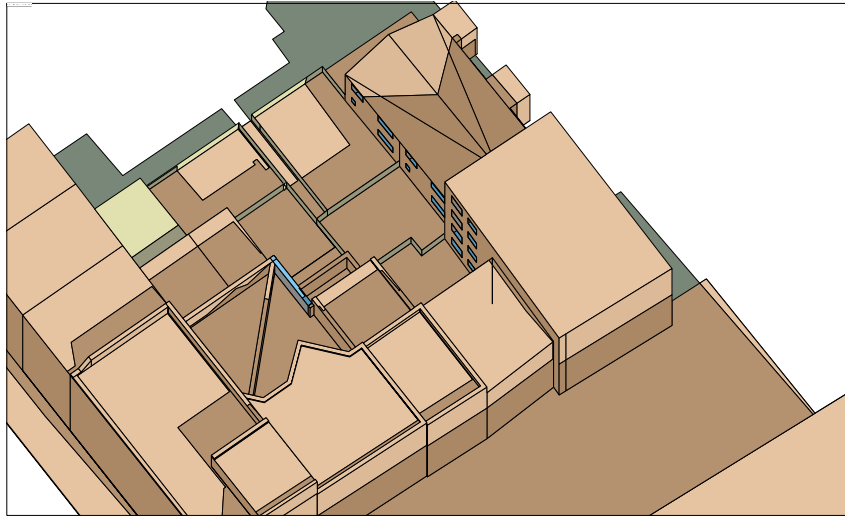
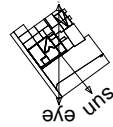

Existing

Suncast image:

View time = 21 Mar 10:00
 Site Latitude = 51.48
 Longitude diff. = -0.45
 Model Bearing = 0.00
 Sun: azi = 141.13 alt = 31.35
 Eye: azi = 180.00 alt = 70.00

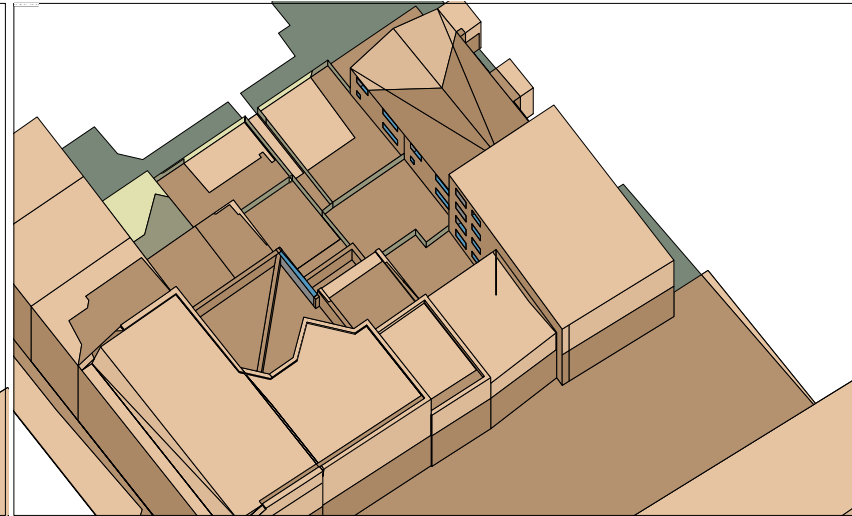
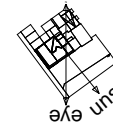

Proposed

Suncast image:

View time = 21 Mar 11:00
 Site Latitude = 51.48
 Longitude diff. = -0.45
 Model Bearing = 0.00
 Sun: azi = 158.28 alt = 36.06
 Eye: azi = 180.00 alt = 70.00

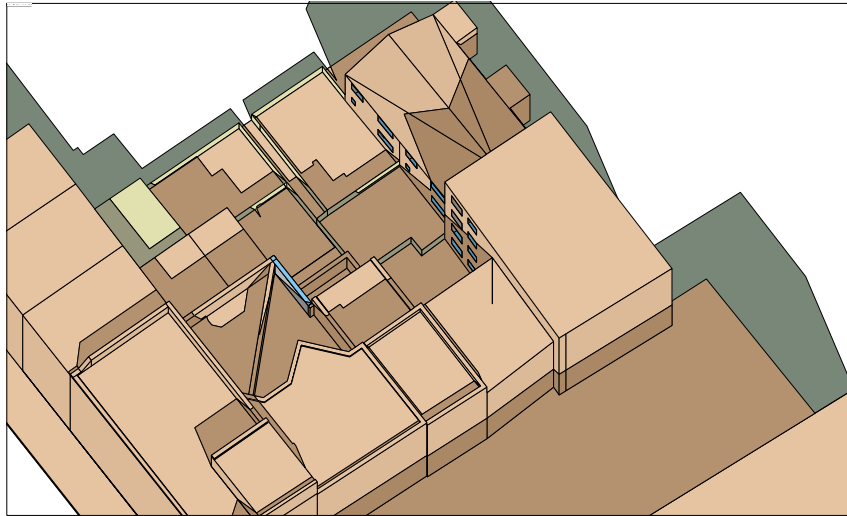
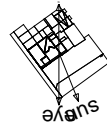

Existing

Suncast image:

View time = 21 Mar 11:00
 Site Latitude = 51.48
 Longitude diff. = -0.45
 Model Bearing = 0.00
 Sun: azi = 158.28 alt = 36.06
 Eye: azi = 180.00 alt = 70.00

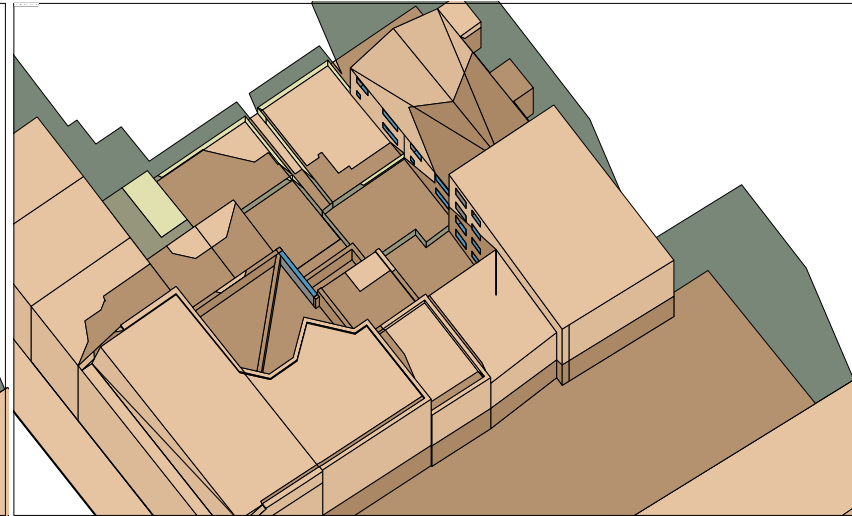
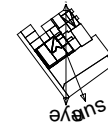

Proposed

Suncast image:

View time = 21 Mar 12:00
 Site Latitude = 51.48
 Longitude diff. = -0.45
 Model Bearing = 0.00
 Sun: azi = 176.94 alt = 38.07
 Eye: azi = 180.00 alt = 70.00

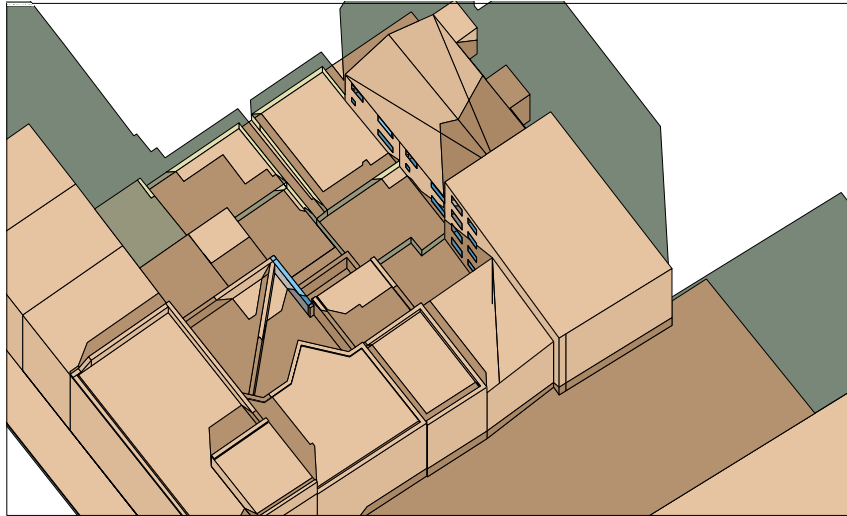
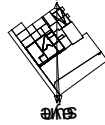

Existing

Suncast image:

View time = 21 Mar 12:00
 Site Latitude = 51.48
 Longitude diff. = -0.45
 Model Bearing = 0.00
 Sun: azi = 176.94 alt = 38.07
 Eye: azi = 180.00 alt = 70.00

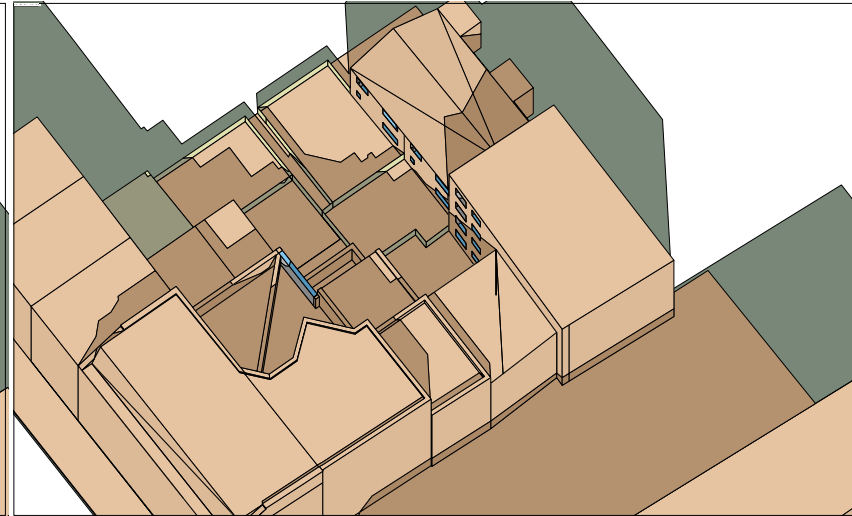
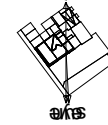

Proposed

Suncast image:

View time = 21 Mar 13:00
 Site Latitude = 51.48
 Longitude diff. = -0.45
 Model Bearing = 0.00
 Sun: azi = 195.84 alt = 37.03
 Eye: azi = 180.00 alt = 70.00

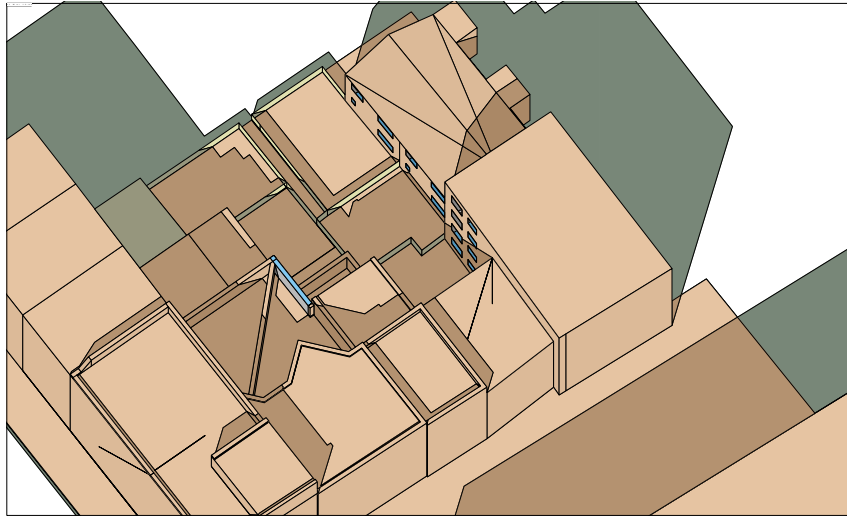
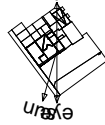

Existing

Suncast image:

View time = 21 Mar 13:00
 Site Latitude = 51.48
 Longitude diff. = -0.45
 Model Bearing = 0.00
 Sun: azi = 195.84 alt = 37.03
 Eye: azi = 180.00 alt = 70.00

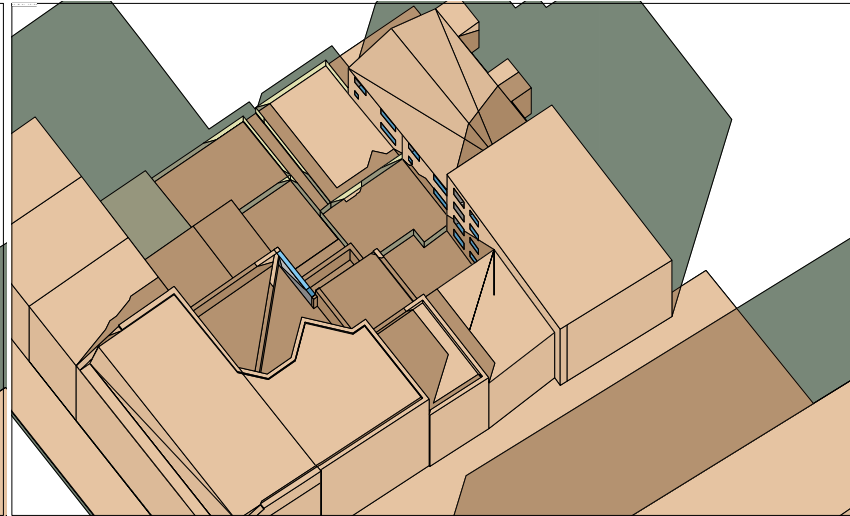

Proposed

Suncast image:

View time = 21 Mar 14:00
 Site Latitude = 51.48
 Longitude diff. = -0.45
 Model Bearing = 0.00
 Sun: azi = 213.57 alt = 33.12
 Eye: azi = 180.00 alt = 70.00

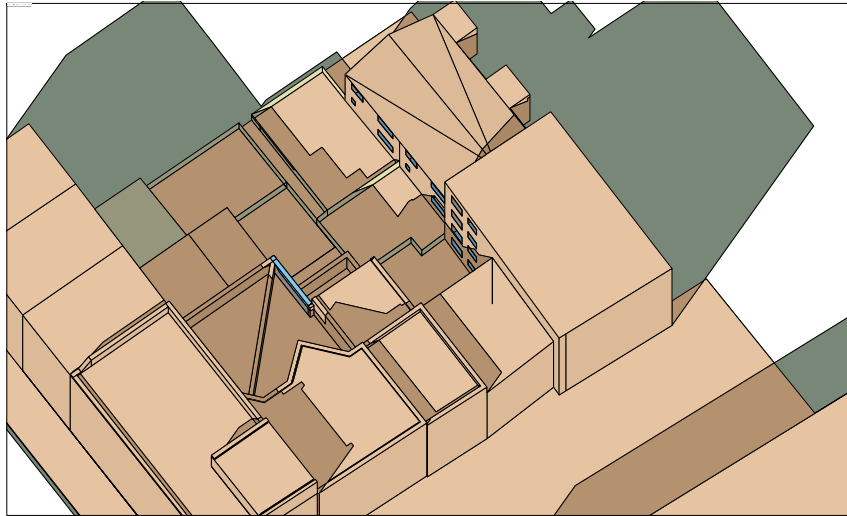
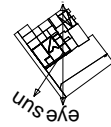

Existing

Suncast image:

View time = 21 Mar 14:00
 Site Latitude = 51.48
 Longitude diff. = -0.45
 Model Bearing = 0.00
 Sun: azi = 213.57 alt = 33.12
 Eye: azi = 180.00 alt = 70.00

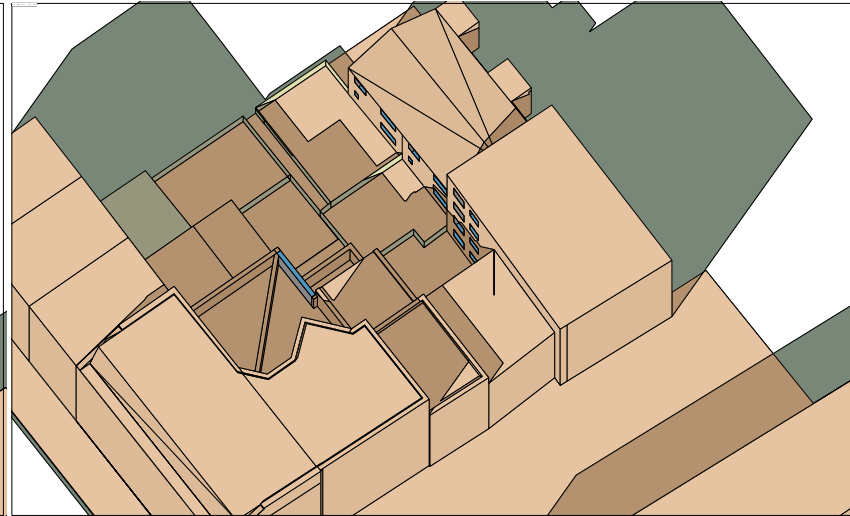

Proposed

Suncast image:

View time = 21 Mar 15:00
 Site Latitude = 51.48
 Longitude diff. = -0.45
 Model Bearing = 0.00
 Sun: azi = 229.38 alt = 26.93
 Eye: azi = 180.00 alt = 70.00

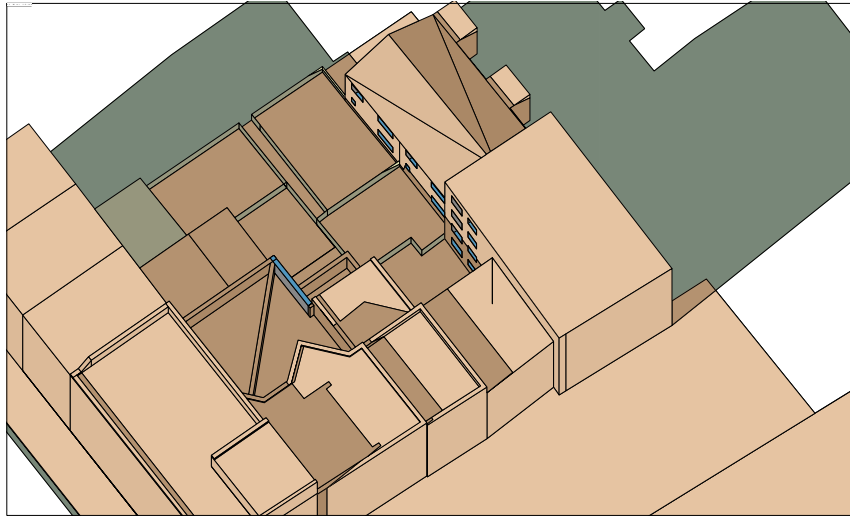
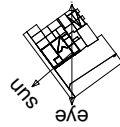

Existing

Suncast image:

View time = 21 Mar 15:00
 Site Latitude = 51.48
 Longitude diff. = -0.45
 Model Bearing = 0.00
 Sun: azi = 229.38 alt = 26.93
 Eye: azi = 180.00 alt = 70.00

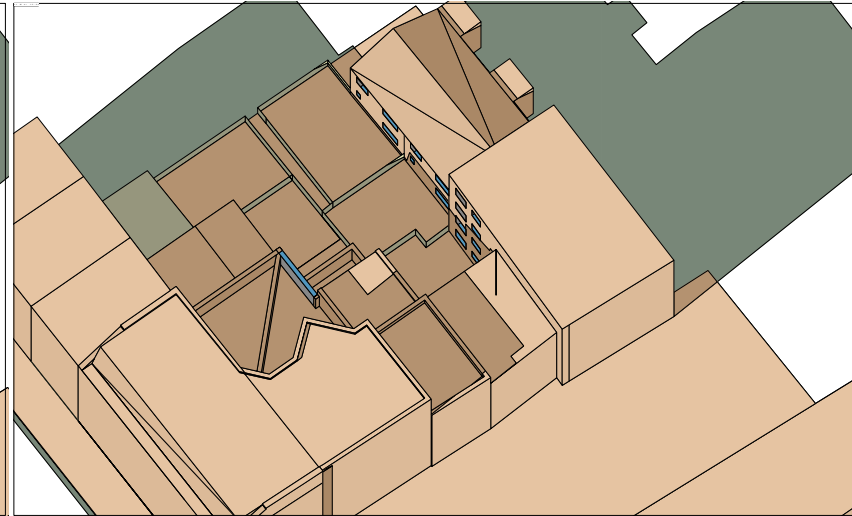
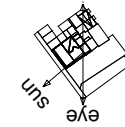

Proposed

Suncast image:

View time = 21 Mar 16:00
 Site Latitude = 51.48
 Longitude diff. = -0.45
 Model Bearing = 0.00
 Sun: azi = 243.34 alt = 19.16
 Eye: azi = 180.00 alt = 70.00

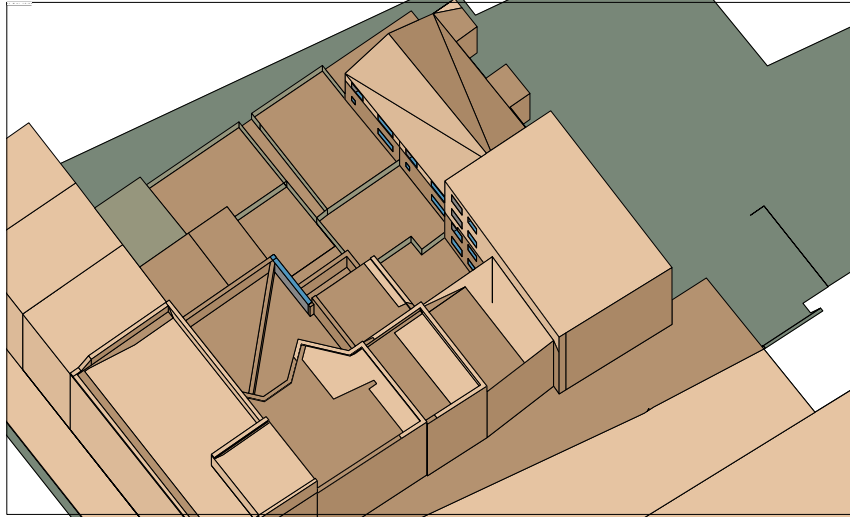
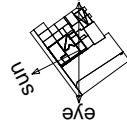

Existing

Suncast image:

View time = 21 Mar 16:00
 Site Latitude = 51.48
 Longitude diff. = -0.45
 Model Bearing = 0.00
 Sun: azi = 243.34 alt = 19.16
 Eye: azi = 180.00 alt = 70.00

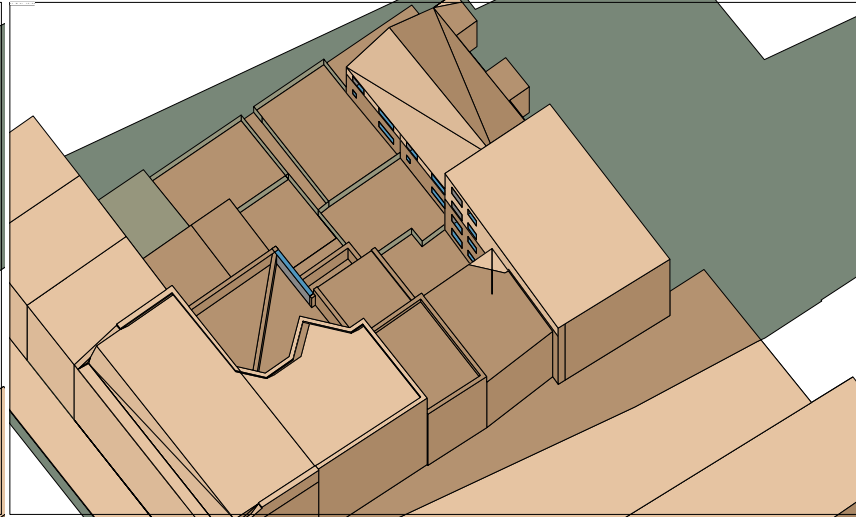
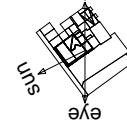

Proposed

Suncast image:

View time = 21 Mar 17:00
 Site Latitude = 51.48
 Longitude diff. = -0.45
 Model Bearing = 0.00
 Sun: azi = 255.96 alt = 10.42
 Eye: azi = 180.00 alt = 70.00

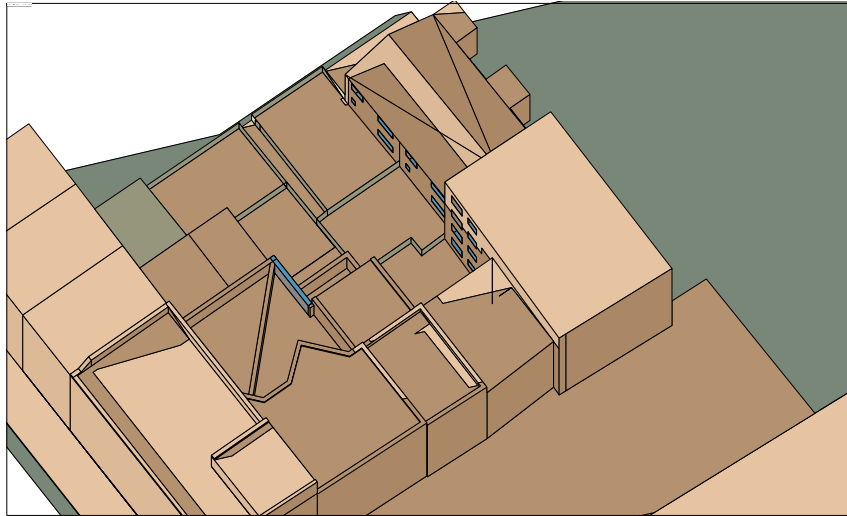
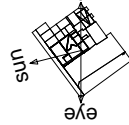

Existing

Suncast image:

View time = 21 Mar 17:00
 Site Latitude = 51.48
 Longitude diff. = -0.45
 Model Bearing = 0.00
 Sun: azi = 255.96 alt = 10.42
 Eye: azi = 180.00 alt = 70.00

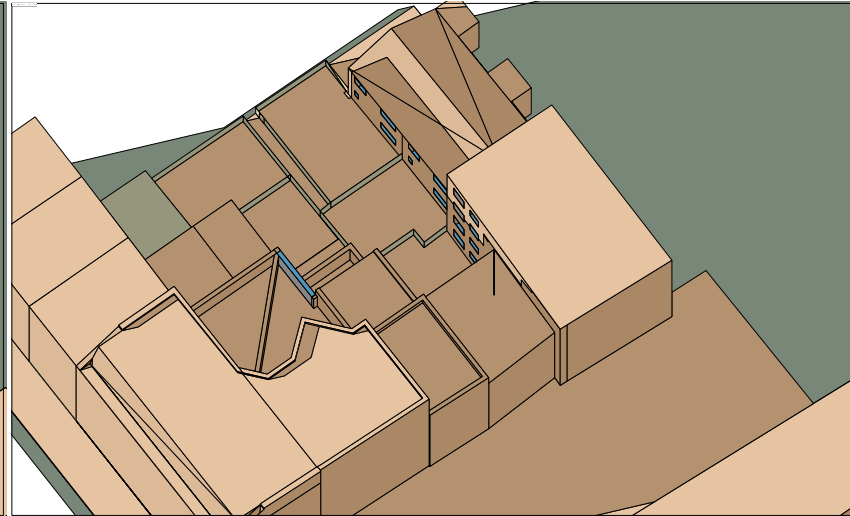
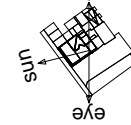

Proposed