



- **21.5% efficiency**

Ideal for roofs where space is at a premium or where future expansion might be needed.

- **Maximum performance**

Designed to deliver the most energy in demanding real world conditions, in partial shade and hot rooftop temperatures.<sup>1, 2, 3</sup>

- **Premium aesthetics**

SunPower® Signature™ Black X-Series panels blend harmoniously into your roof. The most elegant choice for your home.

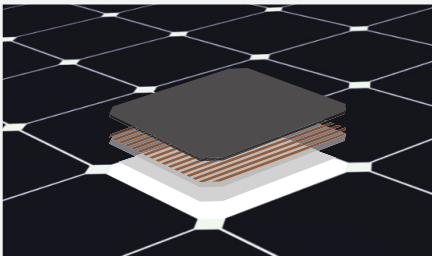

**Moxeon® Solar Cells: Fundamentally better.**

Engineered for performance, designed for durability.

**Engineered for peace of mind**

Designed to deliver consistent, trouble-free energy over a very long lifetime.<sup>4,5</sup>

**Designed for durability**

The SunPower Moxeon Solar Cell is the only cell built on a solid copper foundation. Virtually impervious to the corrosion and cracking that degrade Conventional Panels.<sup>4,5</sup>

Same excellent durability as E-Series panels.

**#1 Ranked** in Fraunhofer durability test.<sup>10</sup>

**100% power** maintained in Atlas 25+ comprehensive PVDI Durability test.<sup>11</sup>

**StGiles: X21-345 type, 345Wp, 21.5% efficient**

UNMATCHED PERFORMANCE, RELIABILITY & AESTHETICS

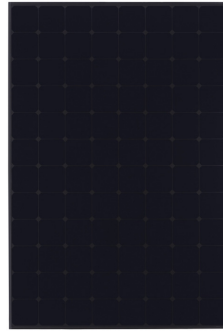

SIGNATURE™ BLACK  
X21 - 335 PANEL

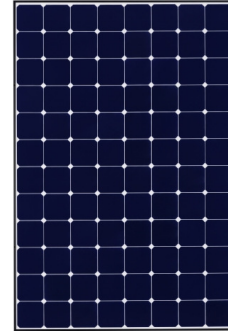

X21 - 345 PANEL



**HIGHEST EFFICIENCY<sup>6</sup>**

**Generate more energy per square foot**

X-Series residential panels convert more sunlight to electricity producing 44% more power per panel,<sup>1</sup> and 75% more energy per square foot over 25 years.<sup>3,4</sup>

**HIGHEST ENERGY PRODUCTION<sup>7</sup>**

**Produce more energy per rated watt**

High year one performance delivers 8-10% more energy per rated watt.<sup>3</sup> This advantage increases over time, producing 21% more energy over the first 25 years to meet your needs.<sup>4</sup>

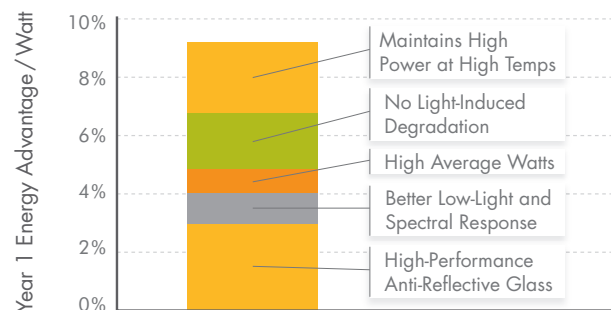
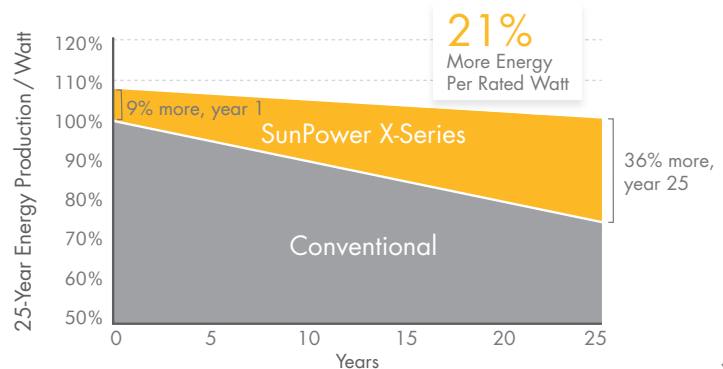

Awarded to SunPower E-Series. X-Series delivers even more energy.<sup>7</sup>

SUNPOWER OFFERS THE BEST COMBINED POWER AND PRODUCT WARRANTY

### POWER WARRANTY

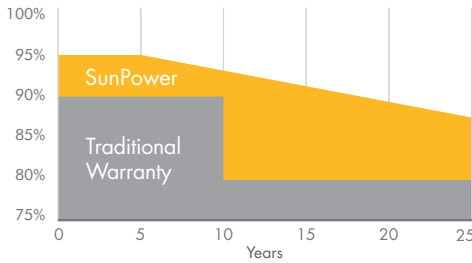

More guaranteed power: 95% for first 5 years, -0.4%/yr. to year 25. <sup>8</sup>

### PRODUCT WARRANTY

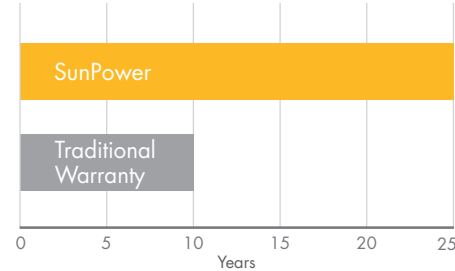

Combined Power and Product Defect 25 year coverage that includes panel replacement costs. <sup>9</sup>

### ELECTRICAL DATA

	X21-335-BLK	X21-345
Nominal Power <sup>12</sup> (P <sub>nom</sub> )	335 W	345 W
Power Tolerance	+5/-0%	+5/-0%
Avg. Panel Efficiency <sup>13</sup>	21.1%	21.5%
Rated Voltage (V <sub>mpp</sub> )	57.3 V	57.3 V
Rated Current (I <sub>mpp</sub> )	5.85 A	6.02 A
Open-Circuit Voltage (V <sub>oc</sub> )	67.9 V	68.2 V
Short-Circuit Current (I <sub>sc</sub> )	6.23 A	6.39 A
Maximum System Voltage	600 V UL ; 1000 V IEC	
Maximum Series Fuse	20 A	
Power Temp Coef. (P <sub>mpp</sub> )	-0.30% / °C	
Voltage Temp Coef. (V <sub>oc</sub> )	-167.4 mV / °C	
Current Temp Coef. (I <sub>sc</sub> )	3.5 mA / °C	

### OPERATING CONDITION AND MECHANICAL DATA

Temperature	- 40°F to +185°F (- 40°C to +85°C)
Max load	Wind: 50 psf, 2400 Pa, 245 kg/m <sup>2</sup> front & back Snow: 112 psf, 5400 Pa, 550kg/m <sup>2</sup> front
Impact resistance	1 inch (25 mm) diameter hail at 52 mph (23 m/s)
Appearance	Class A+
Solar Cells	96 Monocrystalline Maxeon Gen III Cells
Tempered Glass	High Transmission Tempered Anti-Reflective
Junction Box	IP-65 Rated
Connectors	MC4 Compatible
Frame	Class 1 black anodized, highest AAMA Rating
Weight	41 lbs (18.6 kg)

### TESTS AND CERTIFICATIONS

Standard tests	UL 1703, IEC 61215, IEC 61730
Quality tests	ISO 9001:2008, ISO 14001:2004
EHS Compliance	RoHS, OHSAS 18001:2007, lead-free
Ammonia test	IEC 62716
Salt Spray test	IEC 61701 (passed maximum severity)
PID test	Potential-Induced Degradation free: 1000V <sup>10</sup>
Available listings	CEC, UL, TUV, MCS

#### REFERENCES:

- All comparisons are SPR-X21-345 vs. a representative conventional panel: 240W, approx. 1.6 m<sup>2</sup>, 15% efficiency.
- PVEvolution Labs "SunPower Shading Study," Feb 2013.
- Typically 8-10% more energy per watt, BEW/DNV Engineering "SunPower Yield Report," Jan 2013, with CFV Solar Test Lab Report #12063, Jan 2013 temp. coef. calculation.
- SunPower 0.25%/yr degradation vs. 1.0%/yr conv. panel. Campeau, Z. et al. "SunPower Module Degradation Rate," SunPower white paper, Feb 2013; Jordan, Dirk "SunPower Test Report," NREL, Oct 2012.
- "SunPower Module 40-Year Useful Life" SunPower white paper, Feb 2013. Useful life is 99 out of 100 panels operating at more than 70% of rated power.
- Higher than E Series which is highest of all 2600 panels listed in Photon Int'l, Feb 2012.
- 1% more energy than E-Series panels, 8% more energy than the average of the top 10 panel companies tested in 2012 (151 panels, 102 companies), Photon Int'l, Mar 2013.
- Compared with the top 15 manufacturers. SunPower Warranty Review, Feb 2013.
- Some exclusions apply. See warranty for details.
- X-Series same as E-Series, 5 of top 8 panel manufacturers were tested by Fraunhofer ISE, "PV Module Durability Initiative Public Report," Feb 2013.
- Compared with the non-stress-tested control panel. X-Series same as E-Series, tested in Atlas 25+ Durability test report, Feb 2013.
- Standard Test Conditions (1000 W/m<sup>2</sup> irradiance, AM 1.5, 25° C).
- Based on average of measured power values during production.

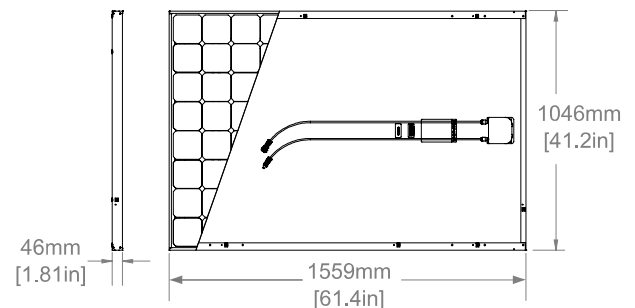

See <http://www.sunpowercorp.com/facts> for more reference information.

For further details, see extended datasheet: [www.sunpowercorp.com/datasheets](http://www.sunpowercorp.com/datasheets) Read safety and installation instructions before using this product.