

Revisions:

00 03 Dec 2014

01 05 Jan 2015

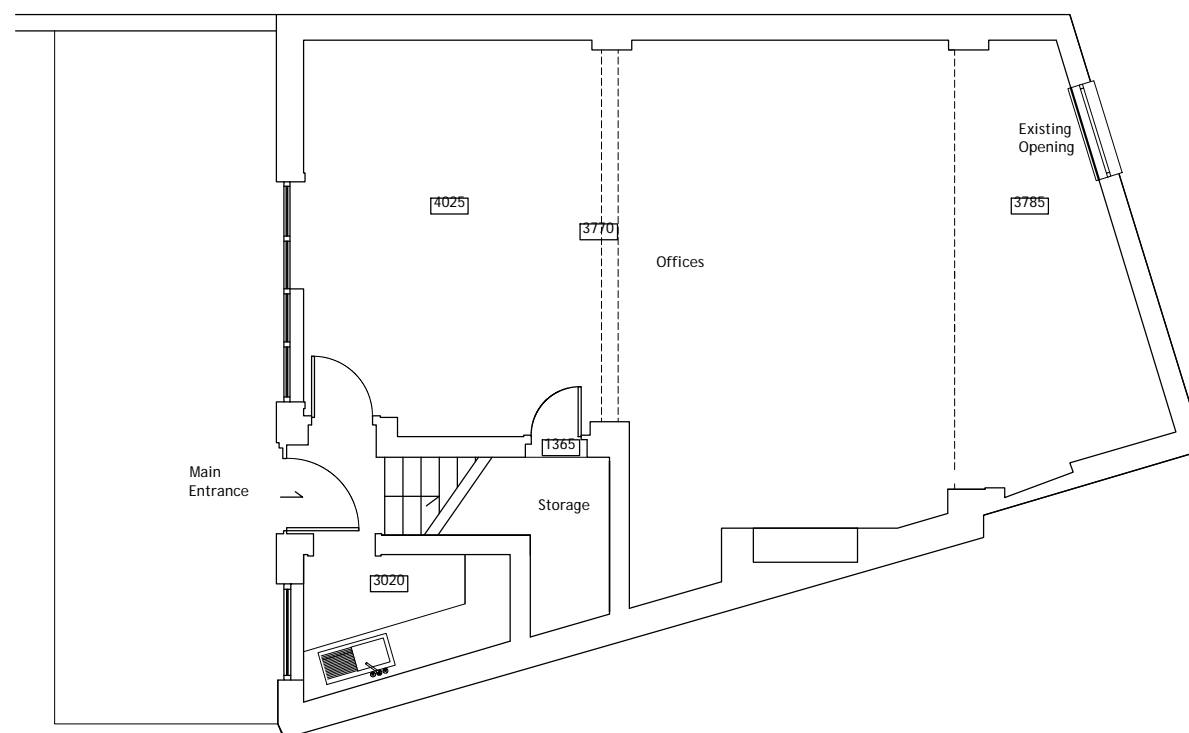

120 Fortune Green
Road
London NW6

1374-D1100-rev01

Scale: 1:100 @ A3
Date: Nov 2014

Ground floor plan:
Existing

Planning

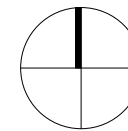

Revisions:

00 03 Dec 2014

01 05 Jan 2015

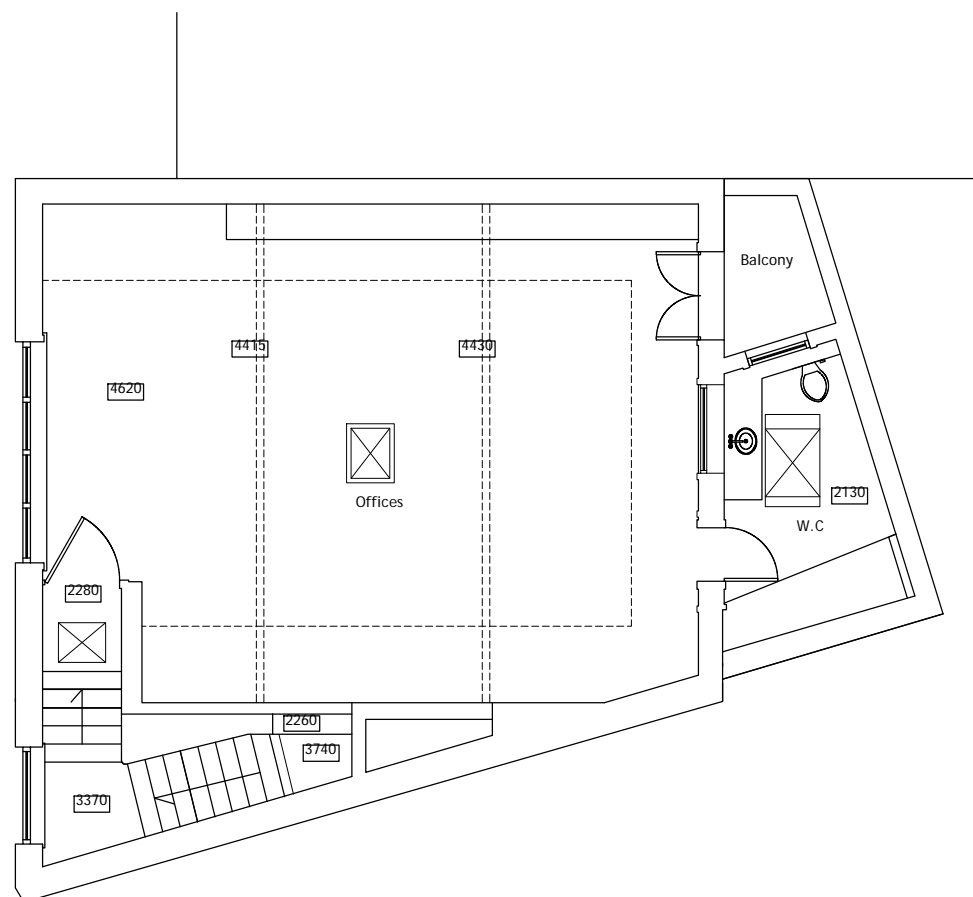

120 Fortune Green
Road
London NW6

1374-D1101-rev01

Scale: 1:100 @ A3
Date: Nov 2014

First floor plan:
Existing

Planning

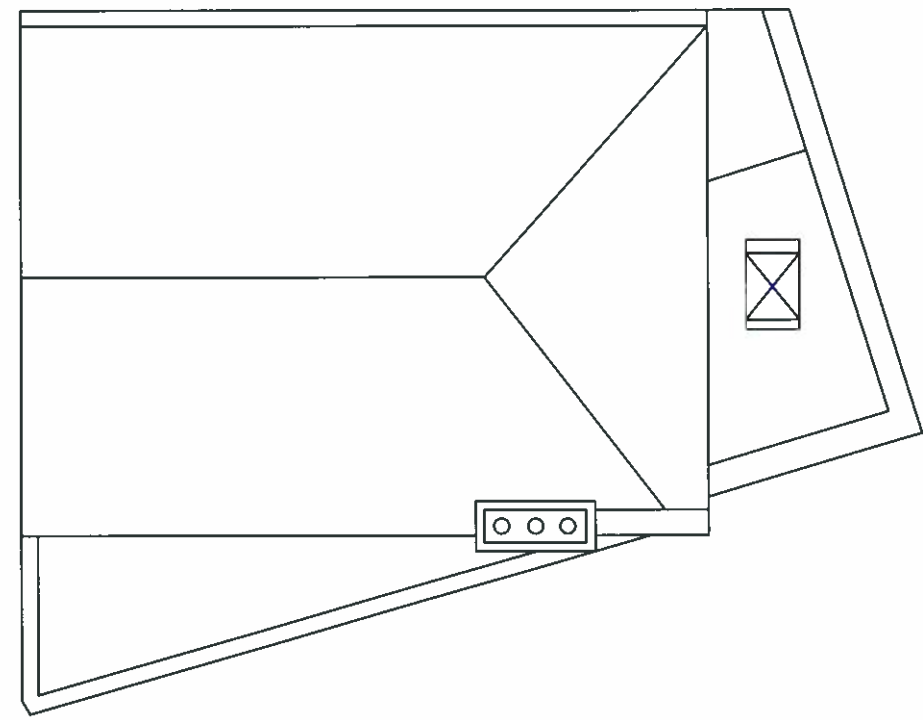

Revisions:
00 03 Dec 2014

120 Fortune Green
Road
London NW6

1374-D1102-rev00

Scale: 1:100 @ A3
Date: Nov 2014

Roof plan:
Existing

Planning

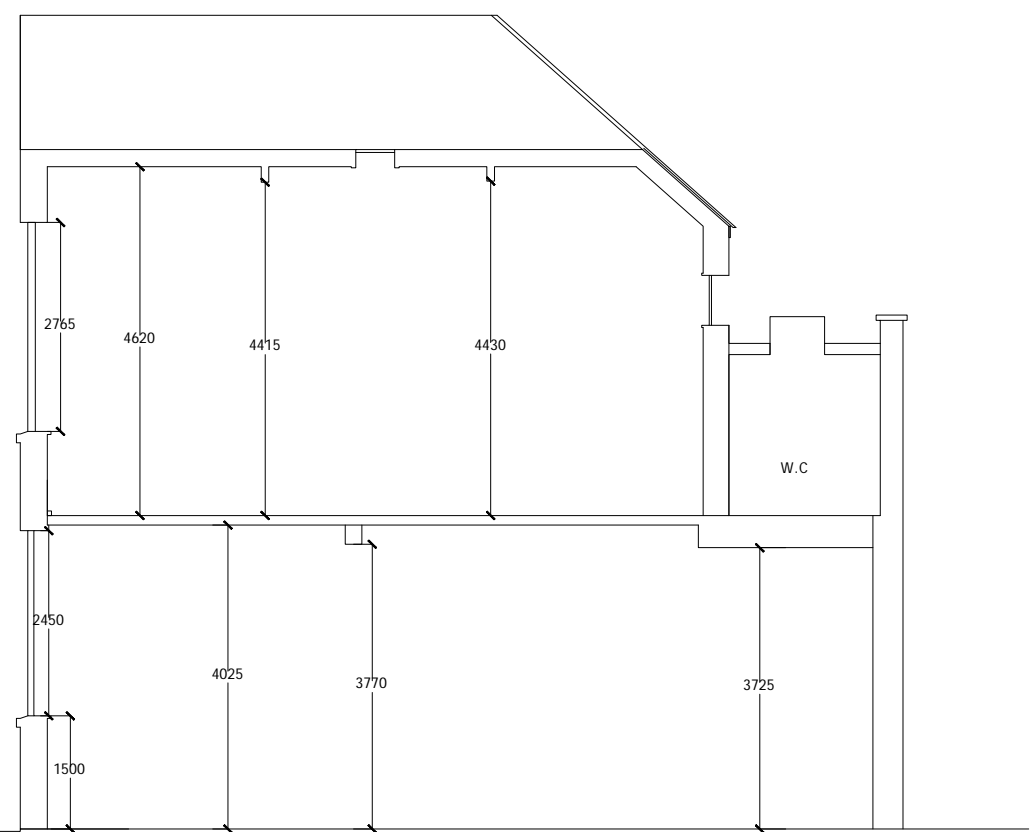

Section YY

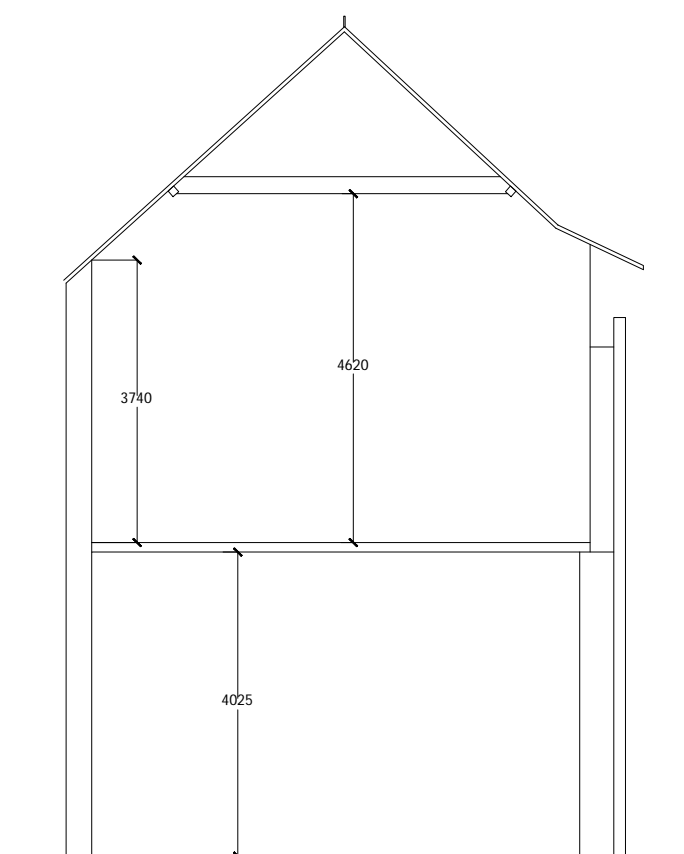

Section ZZ

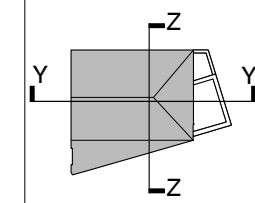

120 Fortune Green
Road
London NW6

1374-D1700-rev02

Scale: 1:50@A1 / 1:100@A3
Date: Nov 2014

Sections YY + ZZ:
Existing

Planning

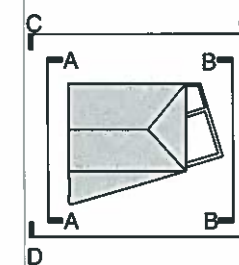

120 Fortune Green
Road
London NW6

1374-D1710-rev00

Scale: 1:50 @ A1
Date: Nov 2014

Elevation AA:
Existing

Planning



Revisions:
00 03 Dec 2014

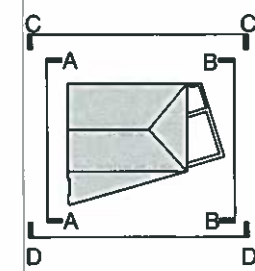

120 Fortune Green
Road
London NW6

1374-D1711-rev00

Scale: 1:50 @ A1
Date: Nov 2014

Elevation BB:
Existing

Planning

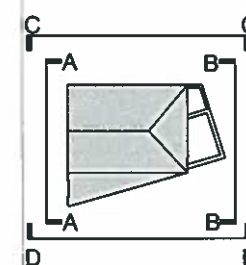
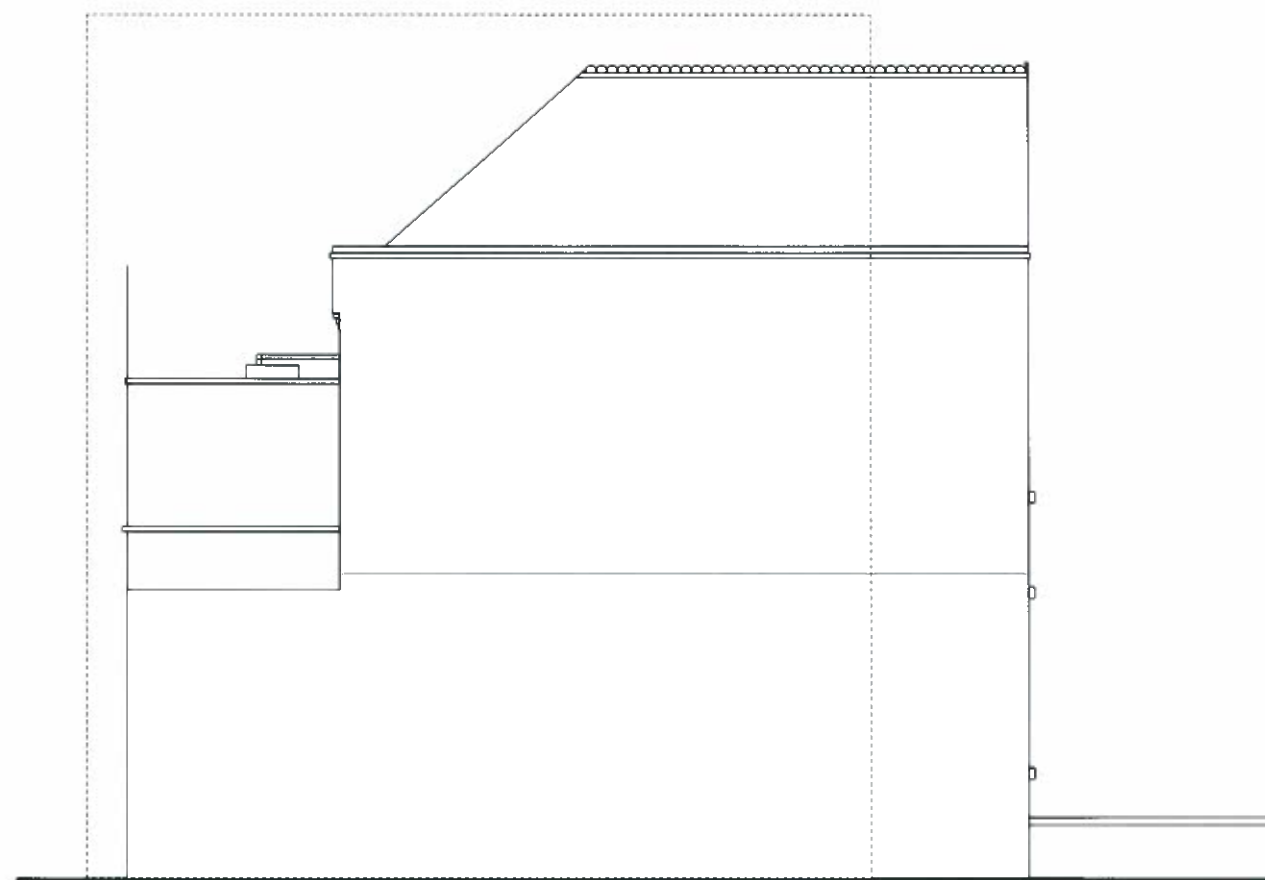

120 Fortune Green
Road
London NW6

1374-D1712-rev00

Scale: 1:50 @ A1
Date: Nov 2014

Elevation CC:
Existing

Planning

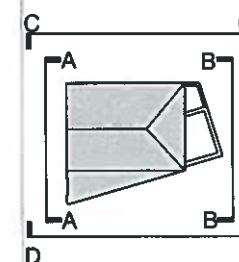
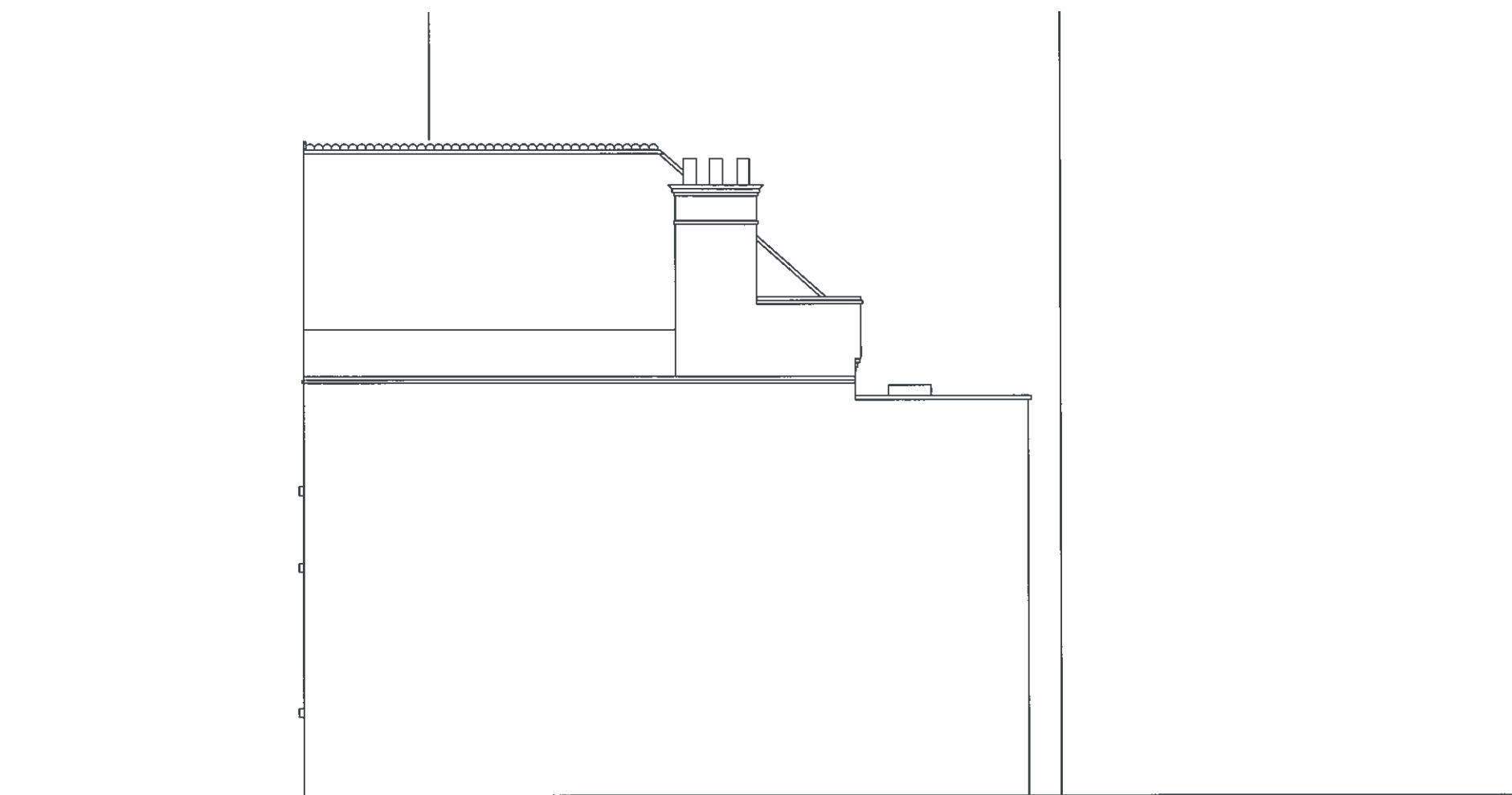

120 Fortune Green
Road
London NW6

1374-D1713-rev00

Scale: 1:50 @ A1
Date: Nov 2014

Elevation DD:
Existing

Planning