

MJL plant information

The plant information included covers the following items:

AHUs

Located internally at level 5, level B2, level 1 and other basement areas. None are visible from outside but they will have an impact on noise levels and have been included in the acoustic model

Attenuators

Again these are located internally and not visible from outside. They have an impact on noise levels and have been included in the acoustic model.

Chillers

These are roof mounted so visible from above or adjacent high buildings. They have an impact on noise levels and have been included in the acoustic model.

Fans

ES/6A01-04 and ES/02/01-02 are dust and solvent extract systems from the conservation studios. These units are located internally and not visible from outside. They have an impact on noise levels and have been included in the acoustic model.

SEF/00/01A and B to 04A and B, SEF/01/1A and B are located on level 1 providing smoke extract, as are SEF/B2/01A and B and 02 A and B. These units are located internally and not visible from outside. They have an impact on noise levels and have been included in the acoustic model.

JEF/00/01 9No jet fans providing pollution control and smoke clearance to the road tunnel below the building. These units are located internally and not visible from outside. They have an impact on noise levels and have been included in the acoustic model.

The flue extract fan data is not yet available as discussed. When it becomes available this will be added to the model.

Michael J Lonsdale

**British Museum
World Conservation
Exhibition Centre - London**

**Revision 05 - Technical Submission
Air Handling Equipment**

**Section No 2
AHU Technical Data**



Reference British Museum - WCEC
AHU Reference AHU B2/03 Building 5 Supply & Extract
Unit Dimensions 2250W x 2850H x 8550L (mm) including 150 base
 The overall unit height shown above includes the base and roof, if fitted. However, overall unit dimensions exclude any externally fitted components such as spigots, dampers, louvres or cowls.

BASIC UNIT INFORMATION

Model Ref MA50/11/S
 Quantity 1
 Location Internal

SUPPLY SIDE

Volume 5.5 m³/s
 External static 300 Pa

EXTRACT SIDE

Volume 4 m³/s
 External static 300 Pa

COMPONENTS (In direction of airflow)**SUPPLY SIDE**

Supply Air Inlet Damper
 Panel Filters
 Bag Filters
 Recuperator c/w Recirculation Damper
 Supply Fan - "Run & Standby Motors"
 Diffuser
 CW Cooler
 Service Access Section
 LPHW Heater
 Service Access Section
 Space For A Future Humidifier

EXTRACT SIDE

Panel Filters
 Extract Fan - "Run & Standby Motors"
 Diffuser
 Recuperator c/w Recirculation Damper
 Extract Air Outlet Damper

SEE SEPARATE UNIT SKETCH**TECHNICAL DATA**

Note:- The following information is provided as a guide only and must be checked at time of order

Supply Air Inlet Damper

Damper (Damper Seals:- Side & Blade)
 Air Volume 5.5 m³/s

Panel Filters

Type Panel
 Efficiency G4
 Arrangement 3.5W x 1.5H
 Withdrawal Front
 Manometer Inclined
 1No Set of spare filter media

Bag Filters

Type Bag
 Efficiency F9
 Arrangement 3.5W x 1.5H
 Withdrawal Front
 Manometer Inclined
 1No Set of spare filter media

Recuperator c/w Recirculation Damper

Type Plate Heat Exchanger
 Supply Air On -4 °C
 Supply Air Off 8.9 °C
 Extract Air On Db 22 °C
 Extract Air On RH 50 %
 Efficiency (Sup) 50.0 %
 Heat Recovered 85 kW
 Special Features Face & By-pass Damper
 Recirculation Damper

Continued ...

Supply Fan - "Run & Standby Motors"

Volume 5.5 m³/s
 External static 300 Pa
 Total static 1435 Pa
 Absorbed power 9.84 kW
 Motor power 15 kW (IE2)
 Motor type Standard/Single Speed
 Motor position Face on
 Fan type DIDW / Backward curved / Belt driven
 Fan speed 1452 RPM
 Outlet velocity 8.64 m/s
 Total fan efficiency 80.0 %
 Electrical Supply 400V-3Ph-50Hz
 Fan discharge SWL levels 63 125 250 500 1000 2000 4000 8000 (Hz)
 (to BS848) 99 93 90 89 86 82 77 69
 Includes +4dB fan in casework adjustment
 Drive guards fitted? YES
 Suitable for inverters? YES
 Isolator fitted? YES
 Standby motor fitted? YES
 Thermistors fitted? YES
 1No spare set of belts

CW Cooler

Volume 5.5 m³/s
 Air On Coil Db 30 °C
 Air On Coil Wb 20 °C
 Air Off Coil Db 11.4 °C
 Air Off Coil Wb 10.8 °C
 Duty 171.66 kW
 Face velocity 2.9 m/s
 Medium Chilled Water
 Flow Temp 5 °C
 Return Temp 11 °C
 Flow Rate 6.81 l/s
 Water Pd 25 KPa
 Rows/Fins 8R/8F
 No of Sections 1
 Construction Copper/Aluminium
 Eliminators YES
 Drain Pan Fixed

LPHW Heater

Volume 5.5 m³/s
 Air On Coil Db 5 °C
 Air Off Coil Db 30 °C
 Duty 165 kW
 Face velocity 2.9 m/s
 Medium LTHW
 Flow Temp 80 °C
 Return Temp 50 °C
 Flow Rate 1.35 l/s
 Water Pd 3 KPa
 Rows/Fins 2R/10F
 No of Sections 1
 Construction Copper/Aluminium

Space For A Future Humidifier**Panel Filters**

Type Panel
 Efficiency G4
 Arrangement 3.5W x 1.5H
 Withdrawal Side
 Manometer Inclined
 1No Set of spare filter media

Continued ...

Extract Fan - "Run & Standby Motors"

Volume 4 m³/s
 External static 300 Pa
 Total static 814 Pa
 Absorbed power 4.13 kW
 Motor power 7.5 kW (IE2)
 Motor type Standard/Single Speed
 Motor position Face on
 Fan type DIDW / Backward curved / Belt driven
 Fan speed 1513 RPM
 Outlet velocity 9.92 m/s
 Total fan efficiency 79.0 %
 Electrical Supply 400V-3Ph-50Hz
 Fan discharge SWL levels 63 125 250 500 1000 2000 4000 8000 (Hz)
 (to BS848) 95 89 86 85 82 78 73 65
 Includes +4dB fan in casework adjustment
 Drive guards fitted? YES
 Suitable for inverters? YES
 Isolator fitted? YES
 Standby motor fitted? YES
 Thermistors fitted? YES
 1No spare set of belts

Recuperator c/w Recirculation Damper**Extract Air Outlet Damper**

Damper (Damper Seals:- Side & Blade)
 Air Volume 4 m³/s

Approximate weight of unit 5757 kg

Reference British Museum - WCEC
AHU Reference AHU/B2/04 B2 Plantroom
Unit Dimensions 1650W x 2515H x 5850L (mm) including 165 base
 The overall unit height shown above includes the base and roof, if fitted. However, overall unit dimensions exclude any externally fitted components such as spigots, dampers, louvres or cowls.

BASIC UNIT INFORMATION

Model Ref MA50/5/S
 Quantity 1
 Location Internal

SUPPLY SIDE

Volume 3.2 m³/s
 External static 350 Pa

EXTRACT SIDE

Volume 3.2 m³/s
 External static 350 Pa

COMPONENTS (In direction of airflow)**SUPPLY SIDE**

Supply Air Inlet Damper
 Service Access Section
 Panel Filters
 Bag Filters
 Hygroscopic Thermal Wheel Single Piece
 Recirculation Damper
 CW Cooler
 Service Access Section
 LPHW Heater
 Supply Fan - Internal Run Only Motor

EXTRACT SIDE

Panel Filters
 Extract Fan - Internal Run Only Motor
 Diffuser
 Recirculation Damper
 Hygroscopic Thermal Wheel Single Piece
 Extract Air Outlet Damper

SEE SEPARATE UNIT SKETCH**TECHNICAL DATA**

Note:- The following information is provided as a guide only and must be checked at time of order

Supply Air Inlet Damper

Damper (Damper Seals:- Side & Blade)
 Air Volume 3.2 m³/s

Panel Filters

Type Panel
 Efficiency G4
 Arrangement 2.5W x 1.5H
 Withdrawal Front
 Manometer Inclined
 1No Set of spare filter media

Bag Filters

Type Bag
 Efficiency F9
 Arrangement 2.5W x 1.5H
 Withdrawal Front
 Manometer Inclined
 1No Set of spare filter media

Hygroscopic Thermal Wheel Single Piece

Type	Hygroscopic	
Conditions	Winter	Summer
Supply Air On	-4 °C	28 °C
Supply Air Off	14 °C	25.9 °C
Extract Air On Db	22 °C	25 °C
Extract Air On RH	50 %	50 %
Efficiency (Sup)	69.0 %	70.0 %
Heat Recovered	99 kW	12 kW
Special Features	Speed control	

Recirculation Damper

Damper (Damper Seals:- Side & Blade)
 Air Volume 2.88 m³/s

Continued ...

CW Cooler

Volume 3.2 m³/s
 Air On Coil Db 30 °C
 Air On Coil Wb 20 °C
 Air Off Coil Db 11.4 °C
 Air Off Coil Wb 10.8 °C
 Duty 99.87 kW
 Face velocity 2.6 m/s
 Medium Chilled Water
 Flow Temp 5 °C
 Return Temp 11 °C
 Flow Rate 3.96 l/s
 Water Pd 16 KPa
 Rows/Fins 6R/10F
 No of Sections 1
 Construction Copper/Aluminium
 Eliminators YES
 Drain Pan Fixed

LPHW Heater

Volume 3.2 m³/s
 Air On Coil Db 5 °C
 Air Off Coil Db 30 °C
 Duty 96.48 kW
 Face velocity 2.6 m/s
 Medium LTHW
 Flow Temp 80 °C
 Return Temp 50 °C
 Flow Rate 0.78 l/s
 Water Pd 7 KPa
 Rows/Fins 2R/8F
 No of Sections 1
 Construction Copper/Aluminium

Supply Fan - Internal Run Only Motor

Volume 3.2 m³/s
 External static 350 Pa
 Total static 1238 Pa
 Absorbed power 5.17 kW
 Motor power 7.5 kW (IE2)
 Motor type Standard/Single Speed
 Motor position Face on
 Fan type DIDW / Backward curved / Belt driven
 Fan speed 1709 RPM
 Outlet velocity 7.94 m/s
 Total fan efficiency 80.0 %
 Electrical Supply 400V-3Ph-50Hz
 Fan discharge SWL levels

	63	125	250	500	1000	2000	4000	8000 (Hz)
(to BS848)	96	90	87	86	83	79	74	66

Includes +4dB fan in casework adjustment

Drive guards fitted? YES
 Suitable for inverters? YES
 Isolator fitted? YES
 Standby motor fitted? NO
 Thermistors fitted? YES
 1No spare set of belts

Panel Filters

Type Panel
 Efficiency G4
 Arrangement 2.5W x 1.5H
 Withdrawal Side
 Manometer Inclined
 1No Set of spare filter media

Continued ...

Extract Fan - Internal Run Only Motor

Volume 3.2 m³/s
 External static 350 Pa
 Total static 827 Pa
 Absorbed power 3.78 kW
 Motor power 5.5 kW (IE2)
 Motor type Standard/Single Speed
 Motor position Face on
 Fan type DIDW / Backward curved / Belt driven
 Fan speed 1800 RPM
 Outlet velocity 9.99 m/s
 Total fan efficiency 80.0 %
 Electrical Supply 400V-3Ph-50Hz
 Fan discharge SWL levels 63 125 250 500 1000 2000 4000 8000 (Hz)
 (to BS848) 96 90 87 86 83 79 74 66
 Includes +4dB fan in casework adjustment
 Drive guards fitted? YES
 Suitable for inverters? YES
 Isolator fitted? YES
 Standby motor fitted? NO
 Thermistors fitted? YES
 1No spare set of belts

Recirculation Damper

Air Volume 2.88 m³/s

Hygroscopic Thermal Wheel Single Piece**Extract Air Outlet Damper**

Damper (Damper Seals:- Side & Blade)
 Air Volume 3.2 m³/s

Approximate weight of unit 3485 kg

Reference British Museum - WCEC
AHU Reference AHU B3/01.02.B2/01.02,B1/01,02 & 02/01
Unit Dimensions 1350W x 2625H x 2100L (mm)
 The overall unit height shown above includes the base and roof, if fitted. However, overall unit dimensions exclude any externally fitted components such as spigots, dampers, louvres or cowls.

BASIC UNIT INFORMATION

Model Ref MA50/2/S
Quantity 7
Location Internal

SUPPLY SIDE

Volume 1.9 m³/s
External static 250 Pa

COMPONENTS (In direction of airflow)**SUPPLY SIDE**

Supply Air Inlet Damper	Turning Section
Recirculation Plenum	600mm Silencer
Panel Filters	Supply Fan - "Run & Standby Motors"
Bag Filters	
LPHW Heater	
CW Cooler	

SEE SEPARATE UNIT SKETCH**TECHNICAL DATA**

Note:- The following information is provided as a guide only and must be checked at time of order

Supply Air Inlet Damper

Damper (Damper Seals:- Side & Blade)
Air Volume 1.9 m³/s

Recirculation Plenum

Flange/Spigot
Air Volume 1.9 m³/s

Panel Filters

Type Panel
Efficiency G4
Arrangement 2W x 1.5H
Withdrawal Front
Manometer Inclined
 1No Set of spare filter media

Bag Filters

Type Bag
Efficiency F9
Arrangement 2W x 1.5H
Withdrawal Front
Manometer Inclined
 1No Set of spare filter media

LPHW Heater

Volume 1.9 m³/s
Air On Coil Db 15.5 °C
Air Off Coil Db 18.9 °C
Duty 7.79 kW
Face velocity 3.2 m/s
Medium LTHW
Flow Temp 80 °C
Return Temp 50 °C
Flow Rate 0.06 l/s
Water Pd 1 KPa
Rows/Fins 1R/5F
No of Sections 1
Construction Copper/Aluminium

Continued ...

CW Cooler

Volume 1.9 m³/s
 Air On Coil Db 19.5 °C
 Air On Coil Wb 13.4 °C
 Air Off Coil Db 14.1 °C
 Air Off Coil Wb 11.1 °C
 Duty 13.06 kW
 Face velocity 2.5 m/s
 Medium Chilled Water
 Flow Temp 5 °C
 Return Temp 11 °C
 Flow Rate 0.52 l/s
 Water Pd 16 KPa
 Rows/Fins 2R/10F
 No of Sections 1
 Construction Copper/Aluminium

 Drain Pan Fixed

Turning Section

Air Volume 1.9 m³/s

600mm Silencer

	63	125	250	500	1000	2000	4000	8000 (Hz)
Static insertion loss	7	11	19	24	33	30	23	18

Supply Fan - "Run & Standby Motors"

Volume 1.9 m³/s
 External static 250 Pa
 Total static 325 Pa
 Absorbed power 2.62 kW
 Motor power 4 kW (IE2)
 Motor type Standard/Single Speed
 Motor position Standard
 Fan type DIDW / Backward curved / Belt driven
 Fan speed 2834 RPM
 Outlet velocity 11.82 m/s
 Total fan efficiency 73.0 %
 Electrical Supply 400V-3Ph-50Hz

Fan discharge SWL levels	63	125	250	500	1000	2000	4000	8000 (Hz)
(to BS848)	96	91	89	90	88	84	79	70

Includes +4dB fan in casework adjustment
 Door guard fitted? YES
 Suitable for inverters? YES
 Isolator fitted? YES
 Standby motor fitted? YES
 Thermistors fitted? YES
 1No spare set of belts

Approximate weight of unit 1569 kg

Reference British Museum - WCEC
AHU Reference AHU/00/01 Photosuite Supply
Unit Dimensions 1050W x 3625H x 3600L (mm) including 125 base
 The overall unit height shown above includes the base and roof, if fitted. However, overall unit dimensions exclude any externally fitted components such as spigots, dampers, louvres or cowls.

BASIC UNIT INFORMATION

Model Ref MA50/1/S
 Quantity 1
 Location Internal

SUPPLY SIDE

Volume 1.5 m³/s
 External static 300 Pa

COMPONENTS (In direction of airflow)**SUPPLY SIDE**

Supply Air Inlet Damper	Supply Fan - Internal Run Only Motor
Recirculation Damper	Diffuser
Panel Filters	LPHW Heater
Bag Filters	900mm Silencer
600mm Silencer	
CW Cooler	

SEE SEPARATE UNIT SKETCH**TECHNICAL DATA**

Note:- The following information is provided as a guide only and must be checked at time of order

Supply Air Inlet Damper

Damper (Damper Seals:- Side & Blade)
 Air Volume 1.5 m³/s

Recirculation Damper

Damper (Damper Seals:- Side & Blade)
 Air Volume 1.35 m³/s

Panel Filters

Type Panel
 Efficiency G4
 Arrangement 1.5W x 1H
 Withdrawal Front
 Manometer Inclined
 1No Set of spare filter media

Bag Filters

Type Bag
 Efficiency F9
 Arrangement 1.5W x 1H
 Withdrawal Front
 Manometer Inclined
 1No Set of spare filter media

600mm Silencer

	63	125	250	500	1000	2000	4000	8000 (Hz)
Static insertion loss	5	8	16	21	28	25	19	15

CW Cooler

Volume 1.5 m³/s
 Air On Coil Db 26.5 °C
 Air On Coil Wb 18.5 °C
 Air Off Coil Db 11.44 °C
 Air Off Coil Wb 10.9 °C
 Duty 37.5 kW
 Face velocity 3 m/s
 Medium Chilled Water
 Flow Temp 5 °C
 Return Temp 11 °C
 Flow Rate 1.49 l/s
 Water Pd 13 KPa
 Rows/Fins 6R/10F
 No of Sections 1
 Construction Copper/Aluminium

Continued ...

Drain Pan Fixed

Supply Fan - Internal Run Only Motor

Volume 1.5 m³/s
 External static 300 Pa
 Total static 505 Pa
 Absorbed power 2.71 kW
 Motor power 4 kW (IE2)
 Motor type Standard/Single Speed
 Motor position Standard
 Fan type DIDW / Backward curved / Belt driven
 Fan speed 2948 RPM
 Outlet velocity 9.33 m/s
 Total fan efficiency 76.0 %
 Electrical Supply 400V-3Ph-50Hz
 Fan discharge SWL levels 63 125 250 500 1000 2000 4000 8000 (Hz)
 (to BS848) 99 93 90 89 86 82 77 69
 Includes +4dB fan in casework adjustment
 Door guard fitted? YES
 Suitable for inverters? YES
 Isolator fitted? YES
 Standby motor fitted? NO
 Thermistors fitted? YES
 1No spare set of belts

LPHW Heater

Volume 1.5 m³/s
 Air On Coil Db 10.5 °C
 Air Off Coil Db 30 °C
 Duty 35.27 kW
 Face velocity 3 m/s
 Medium LTHW
 Flow Temp 80 °C
 Return Temp 50 °C
 Flow Rate 0.29 l/s
 Water Pd 5 KPa
 Rows/Fins 2R/8F
 No of Sections 1
 Construction Copper/Aluminium

900mm Silencer

63 125 250 500 1000 2000 4000 8000 (Hz)
 Static insertion loss 9 15 26 31 44 46 34 22

Approximate weight of unit 1778 kg

Reference British Museum - WCEC
 AHU Reference AHU/00/01 Photosuite Extract

BASIC UNIT INFORMATION

Model Ref MA50/1/S
 Quantity 1
 Location Internal

EXTRACT SIDE

Volume 1.5 m³/s
 External static 300 Pa

COMPONENTS (In direction of airflow)

Panel Filters
 Service Access Section
 900mm Silencer
 Turning Section

EXTRACT SIDE

Extract Fan - Internal Run Only Motor
 Diffuser
 600mm Silencer
 Service Access Section
 Recirculation Damper
 Extract Air Outlet Damper

SEE SEPARATE UNIT SKETCH**TECHNICAL DATA**

Note:- The following information is provided as a guide only
 and must be checked at time of order

Panel Filters

Type Panel
 Efficiency G4
 Arrangement 1.5W x 1H
 Withdrawal Side
 Manometer Inclined
 1No Set of spare filter media

900mm Silencer

	63	125	250	500	1000	2000	4000	8000 (Hz)
Static insertion loss	9	15	26	31	44	46	34	22

Turning Section

Air Volume 1.5 m³/s

Extract Fan - Internal Run Only Motor

Volume 1.5 m³/s
 External static 300 Pa
 Total static 527 Pa
 Absorbed power 1.7 kW
 Motor power 3 kW (IE2)
 Motor type Standard/Single Speed
 Motor position Standard
 Fan type DIDW / Backward curved / Belt driven
 Fan speed 2471 RPM
 Outlet velocity 9.33 m/s
 Total fan efficiency 75.0 %
 Electrical Supply 400V-3Ph-50Hz

Fan discharge SWL levels	63	125	250	500	1000	2000	4000	8000 (Hz)
(to BS848)	96	90	87	86	83	79	74	66

Includes +4dB fan in casework adjustment
 Door guard fitted? YES
 Suitable for inverters? YES
 Isolator fitted? YES
 Standby motor fitted? NO
 Thermistors fitted? YES
 1No spare set of belts

Continued ...

600mm Silencer

	63	125	250	500	1000	2000	4000	8000 (Hz)
Static insertion loss	5	8	16	21	28	25	19	15

Recirculation Damper

Air Volume 1.35 m³/s

Extract Air Outlet Damper

Damper (Damper Seals:- Side & Blade)

Air Volume 1.5 m³/s

Approximate weight of unit 1399 kg

Reference British Museum - WCEC
AHU Reference AHU/01/01 & AHU/01/02 Supply & Extract
Unit Dimensions 1050W x 1625H x 5650L (mm) including 125 base
 The overall unit height shown above includes the base and roof, if fitted. However, overall unit dimensions exclude any externally fitted components such as spigots, dampers, louvres or cowls.

BASIC UNIT INFORMATION

Model Ref MA50/1/S
 Quantity 2
 Location Internal

SUPPLY SIDE

Volume 0.6 m³/s
 External static 250 Pa

EXTRACT SIDE

Volume 0.6 m³/s
 External static 250 Pa

COMPONENTS (In direction of airflow)**SUPPLY SIDE**

Supply Air Inlet Damper
 Service Access Section
 Bag Filters
 Hygroscopic Thermal Wheel Single Piece
 Service Access Section
 CW Cooler
 Service Access Section
 LPHW Heater
 Supply Fan

EXTRACT SIDE

Service Access Section
 Bag Filters
 Hygroscopic Thermal Wheel Single Piece
 Extract Fan
 Diffuser
 Extract Air Outlet Damper

SEE SEPARATE UNIT SKETCH**TECHNICAL DATA**

Note:- The following information is provided as a guide only and must be checked at time of order

Supply Air Inlet Damper

Damper (Damper Seals:- Side & Blade)
 Air Volume 0.6 m³/s

Bag Filters

Type Bag
 Efficiency F9
 Arrangement 1.5W x 1H
 Withdrawal Front
 Manometer Inclined
 1No Set of spare filter media

Hygroscopic Thermal Wheel Single Piece

Type Hygroscopic
 Conditions Winter Summer
 Supply Air On -4 °C 28 °C
 Supply Air Off 16.6 °C 25.6 °C
 Extract Air On Db 22 °C 25 °C
 Extract Air On RH 50 % 50 %
 Efficiency (Sup) 79.0 % 80.0 %
 Heat Recovered 21 kW 3 kW
 Special Features Speed control

CW Cooler

Volume 0.6 m³/s
 Air On Coil Db 30 °C
 Air On Coil Wb 20 °C
 Air Off Coil Db 16.45 °C
 Air Off Coil Wb 14.6 °C
 Duty 11.72 kW
 Face velocity 2 m/s
 Medium Chilled Water
 Flow Temp 5 °C
 Return Temp 11 °C
 Flow Rate 0.46 l/s
 Water Pd 5 KPa
 Rows/Fins 3R/10F
 No of Sections 1
 Construction Copper/Aluminium

Continued ...

Eliminators YES
 Drain Pan Fixed
LPHW Heater
 Volume 0.6 m³/s
 Air On Coil Db 15.3 °C
 Air Off Coil Db 21 °C
 Duty 4.1 kW
 Face velocity 2 m/s
 Medium LTHW
 Flow Temp 80 °C
 Return Temp 50 °C
 Flow Rate 0.03 l/s
 Water Pd 5 KPa
 Rows/Fins 1R/5F
 No of Sections 1
 Construction Copper/Aluminium

Supply Fan
 Volume 0.6 m³/s
 External static 250 Pa
 Total static 700 Pa
 Absorbed power 0.62 kW
 Motor power 1.1 kW (IE2)
 Motor type Standard/Single Speed
 Motor position Standard
 Fan type DIDW / Backward curved / Belt driven
 Fan speed 3073 RPM
 Outlet velocity 7.33 m/s
 Total fan efficiency 71.0 %
 Electrical Supply 400V-3Ph-50Hz
 Fan discharge SWL levels 63 125 250 500 1000 2000 4000 8000 (Hz)
 (to BS848) 90 88 84 82 76 72 65 54
 Includes +4dB fan in casework adjustment
 Door guard fitted? YES
 Suitable for inverters? YES
 Isolator fitted? YES
 Standby motor fitted? NO
 Thermistors fitted? YES
 1No spare set of belts

Bag Filters
 Type Bag
 Efficiency F9
 Arrangement 1.5W x 1H
 Withdrawal Front
 Manometer Inclined
 1No Set of spare filter media

Hygroscopic Thermal Wheel Single Piece

Extract Fan
 Volume 0.6 m³/s
 External static 250 Pa
 Total static 727 Pa
 Absorbed power 0.64 kW
 Motor power 1.1 kW (IE2)
 Motor type Standard/Single Speed
 Motor position Standard
 Fan type DIDW / Backward curved / Belt driven
 Fan speed 3121 RPM
 Outlet velocity 7.33 m/s
 Total fan efficiency 71.0 %
 Electrical Supply 400V-3Ph-50Hz
 Fan discharge SWL levels 63 125 250 500 1000 2000 4000 8000 (Hz)
 (to BS848) 91 89 85 83 77 73 66 55
 Includes +4dB fan in casework adjustment
 Door guard fitted? YES
 Suitable for inverters? YES
 Isolator fitted? YES
 Standby motor fitted? NO
 Thermistors fitted? YES
 1No spare set of belts

Extract Air Outlet Damper
 Damper (Damper Seals:- Side & Blade)

Continued ...

Air Volume 0.6 m³/s

Approximate weight of unit 2122 kg

Reference British Museum - WCEC
AHU Reference AHU/05/01 Level 5 Supply & Extract
Unit Dimensions 2100W x 2865H x 5400L (mm) including 165 base
 The overall unit height shown above includes the base and roof, if fitted. However, overall unit dimensions exclude any externally fitted components such as spigots, dampers, louvres or cowls.

BASIC UNIT INFORMATION

Model Ref MA50/10/S
 Quantity 1
 Location Internal

SUPPLY SIDE

Volume 5.2 m³/s
 External static 300 Pa

EXTRACT SIDE

Volume 5.2 m³/s
 External static 300 Pa

COMPONENTS (In direction of airflow)**SUPPLY SIDE**

Supply Air Inlet Damper
 Recirculation Damper
 Panel Filters
 Bag Filters
 Hygroscopic Thermal Wheel Single Piece
 CW Cooler
 Service Access Section
 LPHW Heater
 Supply Fan - Internal Run Only Motor

EXTRACT SIDE

Panel Filters
 Extract Fan - Internal Run Only Motor
 Diffuser
 Hygroscopic Thermal Wheel Single Piece
 Spacer Section
 Recirculation Damper
 Extract Air Outlet Damper

SEE SEPARATE UNIT SKETCH**TECHNICAL DATA**

Note:- The following information is provided as a guide only and must be checked at time of order

Supply Air Inlet Damper

Damper (Damper Seals:- Side & Blade)
 Air Volume 5.2 m³/s

Recirculation Damper

Damper (Damper Seals:- Side & Blade)
 Air Volume 4.68 m³/s

Panel Filters

Type Panel
 Efficiency G4
 Arrangement 3W x 2H
 Withdrawal Front
 Manometer Inclined
 1No Set of spare filter media

Bag Filters

Type Bag
 Efficiency F9
 Arrangement 3W x 2H
 Withdrawal Front
 Manometer Inclined
 1No Set of spare filter media

Hygroscopic Thermal Wheel Single Piece

Type	Hygroscopic	
Conditions	Winter	Summer
Supply Air On	-4 °C	28 °C
Supply Air Off	14.1 °C	25.9 °C
Extract Air On Db	22 °C	25 °C
Extract Air On RH	50 %	50 %
Efficiency (Sup)	70.0 %	70.0 %
Heat Recovered	162 kW	20 kW
Special Features	Speed control	

Continued ...

CW Cooler

Volume 5.2 m³/s
 Air On Coil Db 30 °C
 Air On Coil Wb 20 °C
 Air Off Coil Db 11.6 °C
 Air Off Coil Wb 11 °C
 Duty 159.3 kW
 Face velocity 2.9 m/s
 Medium Chilled Water
 Flow Temp 5 °C
 Return Temp 11 °C
 Flow Rate 6.32 l/s
 Water Pd 28 KPa
 Rows/Fins 7R/8F
 No of Sections 1
 Construction Copper/Aluminium
 Eliminators YES
 Drain Pan Fixed

LPHW Heater

Volume 5.2 m³/s
 Air On Coil Db 5 °C
 Air Off Coil Db 26 °C
 Duty 131.69 kW
 Face velocity 3 m/s
 Medium LTHW
 Flow Temp 80 °C
 Return Temp 50 °C
 Flow Rate 1.07 l/s
 Water Pd 11 KPa
 Rows/Fins 2R/8F
 No of Sections 1
 Construction Copper/Aluminium

Supply Fan - Internal Run Only Motor

Volume 5.2 m³/s
 External static 300 Pa
 Total static 1207 Pa
 Absorbed power 8.62 kW
 Motor power 15 kW (IE2)
 Motor type Standard/Single Speed
 Motor position Face on
 Fan type DIDW / Backward curved / Belt driven
 Fan speed 1933 RPM
 Outlet velocity 12.9 m/s
 Total fan efficiency 79.0 %
 Electrical Supply 400V-3Ph-50Hz
 Fan discharge SWL levels

	63	125	250	500	1000	2000	4000	8000 (Hz)
(to BS848)	101	95	92	91	88	84	79	71

Includes +4dB fan in casework adjustment

Drive guards fitted? YES
 Suitable for inverters? YES
 Isolator fitted? YES
 Standby motor fitted? NO
 Thermistors fitted? YES
 1No spare set of belts

Panel Filters

Type Panel
 Efficiency G4
 Arrangement 3W x 2H
 Withdrawal Side
 Manometer Inclined
 1No Set of spare filter media

Continued ...

Extract Fan - Internal Run Only Motor

Volume 5.2 m³/s
 External static 300 Pa
 Total static 865 Pa
 Absorbed power 6.65 kW
 Motor power 11 kW (IE2)
 Motor type Standard/Single Speed
 Motor position Face on
 Fan type DIDW / Backward curved / Belt driven
 Fan speed 1764 RPM
 Outlet velocity 12.9 m/s
 Total fan efficiency 75.0 %
 Electrical Supply 400V-3Ph-50Hz
 Fan discharge SWL levels 63 125 250 500 1000 2000 4000 8000 (Hz)
 (to BS848) 97 92 90 91 89 85 80 71
 Includes +4dB fan in casework adjustment
 Drive guards fitted? YES
 Suitable for inverters? YES
 Isolator fitted? YES
 Standby motor fitted? NO
 Thermistors fitted? YES
 1No spare set of belts

**Hygroscopic Thermal Wheel Single Piece
 Recirculation Damper**

Air Volume 4.68 m³/s

Extract Air Outlet Damper

Damper (Damper Seals:- Side & Blade)
 Air Volume 5.2 m³/s

Approximate weight of unit 4291 kg

Reference British Museum - WCEC
AHU Reference AHU/05/02 Level 5 Supply & Extract
Unit Dimensions 1650W x 2465H x 5250L (mm) including 165 base
 The overall unit height shown above includes the base and roof, if fitted. However, overall unit dimensions exclude any externally fitted components such as spigots, dampers, louvres or cowls.

BASIC UNIT INFORMATION

Model Ref MA50/3/S
 Quantity 1
 Location Internal

SUPPLY SIDE

Volume 3.1 m³/s
 External static 300 Pa

EXTRACT SIDE

Volume 3.1 m³/s
 External static 300 Pa

COMPONENTS (In direction of airflow)**SUPPLY SIDE**

Supply Air Inlet Damper
 Recirculation Damper
 Panel Filters
 Bag Filters
 Hygroscopic Thermal Wheel Single Piece
 CW Cooler
 Service Access Section
 LPHW Heater
 Supply Fan - Internal Run Only Motor

EXTRACT SIDE

Panel Filters
 Extract Fan - Internal Run Only Motor
 Diffuser
 Hygroscopic Thermal Wheel Single Piece
 Spacer Section
 Recirculation Damper
 Extract Air Outlet Damper

SEE SEPARATE UNIT SKETCH**TECHNICAL DATA**

Note:- The following information is provided as a guide only and must be checked at time of order

Supply Air Inlet Damper

Damper (Damper Seals:- Side & Blade)
 Air Volume 3.1 m³/s

Recirculation Damper

Damper (Damper Seals:- Side & Blade)
 Air Volume 2.79 m³/s

Panel Filters

Type Panel
 Efficiency G4
 Arrangement 2.5W x 1.5H
 Withdrawal Front
 Manometer Inclined
 1No Set of spare filter media

Bag Filters

Type Bag
 Efficiency F9
 Arrangement 2.5W x 1.5H
 Withdrawal Front
 Manometer Inclined
 1No Set of spare filter media

Hygroscopic Thermal Wheel Single Piece

Type	Hygroscopic	
Conditions	Winter	Summer
Supply Air On	-4 °C	28 °C
Supply Air Off	14 °C	25.9 °C
Extract Air On Db	22 °C	25 °C
Extract Air On RH	50 %	50 %
Efficiency (Sup)	69.0 %	70.0 %
Heat Recovered	99 kW	12 kW
Special Features	Speed control	

Continued ...

CW Cooler

Volume 3.1 m³/s
 Air On Coil Db 30 °C
 Air On Coil Wb 20 °C
 Air Off Coil Db 12.1 °C
 Air Off Coil Wb 11.4 °C
 Duty 91.36 kW
 Face velocity 2.58 m/s
 Medium Chilled Water
 Flow Temp 5 °C
 Return Temp 11 °C
 Flow Rate 3.62 l/s
 Water Pd 14 KPa
 Rows/Fins 6R/8F
 No of Sections 1
 Construction Copper/Aluminium
 Eliminators YES
 Drain Pan Fixed

LPHW Heater

Volume 3.1 m³/s
 Air On Coil Db 5 °C
 Air Off Coil Db 30 °C
 Duty 93.46 kW
 Face velocity 2.6 m/s
 Medium LTHW
 Flow Temp 80 °C
 Return Temp 50 °C
 Flow Rate 0.76 l/s
 Water Pd 6 KPa
 Rows/Fins 2R/8F
 No of Sections 1
 Construction Copper/Aluminium

Supply Fan - Internal Run Only Motor

Volume 3.1 m³/s
 External static 300 Pa
 Total static 1161 Pa
 Absorbed power 5.09 kW
 Motor power 7.5 kW (IE2)
 Motor type Standard/Single Speed
 Motor position Face on
 Fan type DIDW / Backward curved / Belt driven
 Fan speed 2401 RPM
 Outlet velocity 12.2 m/s
 Total fan efficiency 79.0 %
 Electrical Supply 400V-3Ph-50Hz
 Fan discharge SWL levels

	63	125	250	500	1000	2000	4000	8000 (Hz)
(to BS848)	101	95	92	91	88	84	79	71

Includes +4dB fan in casework adjustment
 Door guard fitted? YES
 Suitable for inverters? YES
 Isolator fitted? YES
 Standby motor fitted? NO
 Thermistors fitted? YES
 1No spare set of belts

Panel Filters

Type Panel
 Efficiency G4
 Arrangement 2.5W x 1.5H
 Withdrawal Side
 Manometer Inclined
 1No Set of spare filter media

Continued ...

Extract Fan - Internal Run Only Motor

Volume 3.1 m³/s
 External static 300 Pa
 Total static 856 Pa
 Absorbed power 3.83 kW
 Motor power 5.5 kW (IE2)
 Motor type Standard/Single Speed
 Motor position Face on
 Fan type DIDW / Backward curved / Belt driven
 Fan speed 2167 RPM
 Outlet velocity 12.2 m/s
 Total fan efficiency 75.0 %
 Electrical Supply 400V-3Ph-50Hz
 Fan discharge SWL levels 63 125 250 500 1000 2000 4000 8000 (Hz)
 (to BS848) 96 91 89 90 88 84 79 70
 Includes +4dB fan in casework adjustment
 Door guard fitted? YES
 Suitable for inverters? YES
 Isolator fitted? YES
 Standby motor fitted? NO
 Thermistors fitted? YES
 1No spare set of belts

Hygroscopic Thermal Wheel Single Piece Recirculation Damper

Air Volume 2.79 m³/s

Extract Air Outlet Damper

Damper (Damper Seals:- Side & Blade)
 Air Volume 3.1 m³/s

Approximate weight of unit 3318 kg

Reference British Museum - WCEC
AHU Reference AHU/05/03 & 07 Level 5 Supply & Extract
Unit Dimensions 1850W x 2715H x 7350L (mm) including 165 base
 The overall unit height shown above includes the base and roof, if fitted. However, overall unit dimensions exclude any externally fitted components such as spigots, dampers, louvres or cowls.

BASIC UNIT INFORMATION

Model Ref MA50/6/S
 Quantity 2
 Location Internal

SUPPLY SIDE

Volume 4.2 m³/s
 External static 300 Pa

EXTRACT SIDE

Volume 4.2 m³/s
 External static 300 Pa

COMPONENTS (In direction of airflow)**SUPPLY SIDE**

Supply Air Inlet Damper
 Recirculation Damper
 Panel Filters
 Bag Filters
 Hygroscopic Thermal Wheel Single Piece
 CW Cooler
 Service Access Section
 LPHW Heater
 Service Access Section
 Space For A Future Humidifier
 Supply Fan - Internal Run Only Motor

EXTRACT SIDE

Panel Filters
 Extract Fan - Internal Run Only Motor
 Diffuser
 Hygroscopic Thermal Wheel Single Piece
 Spacer Section
 Recirculation Damper
 Extract Air Outlet Damper

SEE SEPARATE UNIT SKETCH

TECHNICAL DATA

Note:- The following information is provided as a guide only
 and must be checked at time of order

Supply Air Inlet Damper

Damper (Damper Seals:- Side & Blade)
 Air Volume 4.2 m³/s

Recirculation Damper

Damper (Damper Seals:- Side & Blade)
 Air Volume 3.78 m³/s

Panel Filters

Type Panel
 Efficiency G4
 Arrangement 2.5W x 2H
 Withdrawal Front
 Manometer Inclined
 1No Set of spare filter media

Bag Filters

Type Bag
 Efficiency F9
 Arrangement 2.5W x 2H
 Withdrawal Front
 Manometer Inclined
 1No Set of spare filter media

Hygroscopic Thermal Wheel Single Piece

Type Hygroscopic
 Conditions Winter Summer
 Supply Air On -4 °C 28 °C
 Supply Air Off 14 °C 25.9 °C
 Extract Air On Db 22 °C 25 °C
 Extract Air On RH 50 % 50 %
 Efficiency (Sup) 69.0 % 70.0 %
 Heat Recovered 130 kW 16 kW
 Special Features Speed control

Continued ...

CW Cooler

Volume 4.2 m³/s
 Air On Coil Db 30 °C
 Air On Coil Wb 20 °C
 Air Off Coil Db 11.9 °C
 Air Off Coil Wb 11.2 °C
 Duty 126.23 kW
 Face velocity 2.9 m/s
 Medium Chilled Water
 Flow Temp 5 °C
 Return Temp 11 °C
 Flow Rate 5.01 l/s
 Water Pd 19 KPa
 Rows/Fins 7R/8F
 No of Sections 1
 Construction Copper/Aluminium
 Eliminators YES
 Drain Pan Fixed

LPHW Heater

Volume 4.2 m³/s
 Air On Coil Db 5 °C
 Air Off Coil Db 26 °C
 Duty 106.37 kW
 Face velocity 2.9 m/s
 Medium LTHW
 Flow Temp 80 °C
 Return Temp 50 °C
 Flow Rate 0.86 l/s
 Water Pd 9 KPa
 Rows/Fins 2R/8F
 No of Sections 1
 Construction Copper/Aluminium

Space For A Future Humidifier**Supply Fan - Internal Run Only Motor**

Volume 4.2 m³/s
 External static 300 Pa
 Total static 1304 Pa
 Absorbed power 7.08 kW
 Motor power 11 kW (IE2)
 Motor type Standard/Single Speed
 Motor position Face on
 Fan type DIDW / Backward curved / Belt driven
 Fan speed 1839 RPM
 Outlet velocity 10.42 m/s
 Total fan efficiency 82.0 %
 Electrical Supply 400V-3Ph-50Hz
 Fan discharge SWL levels 63 125 250 500 1000 2000 4000 8000 (Hz)
 (to BS848) 98 92 89 88 85 81 76 68
 Includes +4dB fan in casework adjustment
 Drive guards fitted? YES
 Suitable for inverters? YES
 Isolator fitted? YES
 Standby motor fitted? NO
 Thermistors fitted? YES
 1No spare set of belts

Panel Filters

Type Panel
 Efficiency G4
 Arrangement 2.5W x 1.5H
 Withdrawal Side
 Manometer Inclined
 1No Set of spare filter media

Continued ...

Extract Fan - Internal Run Only Motor

Volume 4.2 m³/s
 External static 300 Pa
 Total static 893 Pa
 Absorbed power 5.05 kW
 Motor power 7.5 kW (IE2)
 Motor type Standard/Single Speed
 Motor position Face on
 Fan type DIDW / Backward curved / Belt driven
 Fan speed 1621 RPM
 Outlet velocity 10.42 m/s
 Total fan efficiency 80.0 %
 Electrical Supply 400V-3Ph-50Hz
 Fan discharge SWL levels 63 125 250 500 1000 2000 4000 8000 (Hz)
 (to BS848) 97 91 88 87 84 80 75 67
 Includes +4dB fan in casework adjustment
 Drive guards fitted? YES
 Suitable for inverters? YES
 Isolator fitted? YES
 Standby motor fitted? NO
 Thermistors fitted? YES
 1No spare set of belts

Hygroscopic Thermal Wheel Single Piece Recirculation Damper

Air Volume 3.78 m³/s

Extract Air Outlet Damper

Damper (Damper Seals:- Side & Blade)
 Air Volume 4.2 m³/s

Approximate weight of unit 4697 kg

Reference British Museum - WCEC
AHU Reference AHU/05/04 Level 5 Supply & Extract
Unit Dimensions 1800W x 2565H x 7850L (mm) including 165 base
 The overall unit height shown above includes the base and roof, if fitted. However, overall unit dimensions exclude any externally fitted components such as spigots, dampers, louvres or cowls.

BASIC UNIT INFORMATION

Model Ref MA50/6/S
Quantity 1
Location Internal

SUPPLY SIDE

Volume 3.8 m³/s
External static 300 Pa

EXTRACT SIDE

Volume 3.8 m³/s
External static 300 Pa

COMPONENTS (In direction of airflow)**SUPPLY SIDE**

Supply Air Inlet Damper
 Recirculation Damper
 Panel Filters
 Bag Filters
 Hygroscopic Thermal Wheel Single Piece
 CW Cooler
 Service Access Section
 LPHW Heater
 Service Access Section
 Space For A Future Humidifier
 Supply Fan "Run & Standby Motors"

EXTRACT SIDE

Panel Filters
 Extract Fan "Run & Standby Motors"
 Diffuser
 Hygroscopic Thermal Wheel Single Piece
 Spacer Section
 Recirculation Damper
 Extract Air Outlet Damper

SEE SEPARATE UNIT SKETCH**TECHNICAL DATA**

Note:- The following information is provided as a guide only and must be checked at time of order

Supply Air Inlet Damper

Damper (Damper Seals:- Side & Blade)
Air Volume 3.8 m³/s

Recirculation Damper

Damper (Damper Seals:- Side & Blade)
Air Volume 3.42 m³/s

Panel Filters

Type Panel
Efficiency G4
Arrangement 2.5W x 1.5H
Withdrawal Front
Manometer Inclined
 1No Set of spare filter media

Bag Filters

Type Bag
Efficiency F9
Arrangement 2.5W x 1.5H
Withdrawal Front
Manometer Inclined
 1No Set of spare filter media

Hygroscopic Thermal Wheel Single Piece

Type Hygroscopic
Conditions Winter Summer
Supply Air On -4 °C 28 °C
Supply Air Off 14 °C 25.9 °C
Extract Air On Db 22 °C 25 °C
Extract Air On RH 50 % 50 %
Efficiency (Sup) 69.0 % 70.0 %
Heat Recovered 118 kW 14 kW
Special Features Speed control

Continued ...

CW Cooler

Volume 3.8 m³/s
 Air On Coil Db 30 °C
 Air On Coil Wb 20 °C
 Air Off Coil Db 11.85 °C
 Air Off Coil Wb 11.2 °C
 Duty 114.2 kW
 Face velocity 2.7 m/s
 Medium Chilled Water
 Flow Temp 5 °C
 Return Temp 11 °C
 Flow Rate 4.53 l/s
 Water Pd 17 KPa
 Rows/Fins 7R/8F
 No of Sections 1
 Construction Copper/Aluminium
 Eliminators YES
 Drain Pan Fixed

LPHW Heater

Volume 3.8 m³/s
 Air On Coil Db 5 °C
 Air Off Coil Db 26 °C
 Duty 96.24 kW
 Face velocity 3 m/s
 Medium LTHW
 Flow Temp 80 °C
 Return Temp 50 °C
 Flow Rate 0.78 l/s
 Water Pd 1 KPa
 Rows/Fins 2R/10F
 No of Sections 1
 Construction Copper/Aluminium

Space For A Future Humidifier**Supply Fan "Run & Standby Motors"**

Volume 3.8 m³/s
 External static 300 Pa
 Total static 1351 Pa
 Absorbed power 6.56 kW
 Motor power 11 kW (IE2)
 Motor type Standard/Single Speed
 Motor position Face on
 Fan type DIDW / Backward curved / Belt driven
 Fan speed 1816 RPM
 Outlet velocity 9.42 m/s
 Total fan efficiency 81.0 %
 Electrical Supply 400V-3Ph-50Hz
 Fan discharge SWL levels 63 125 250 500 1000 2000 4000 8000 (Hz)
 (to BS848) 98 92 89 88 85 81 76 68
 Includes +4dB fan in casework adjustment
 Drive guards fitted? YES
 Suitable for inverters? YES
 Isolator fitted? YES
 Standby motor fitted? YES
 Thermistors fitted? YES
 1No spare set of belts

Panel Filters

Type Panel
 Efficiency G4
 Arrangement 2.5W x 1.5H
 Withdrawal Side
 Manometer Inclined
 1No Set of spare filter media

Continued ...

Extract Fan "Run & Standby Motors"

Volume 3.8 m³/s
 External static 300 Pa
 Total static 850 Pa
 Absorbed power 4.27 kW
 Motor power 7.5 kW (IE2)
 Motor type Standard/Single Speed
 Motor position Face on
 Fan type DIDW / Backward curved / Belt driven
 Fan speed 1539 RPM
 Outlet velocity 9.42 m/s
 Total fan efficiency 81.0 %
 Electrical Supply 400V-3Ph-50Hz
 Fan discharge SWL levels 63 125 250 500 1000 2000 4000 8000 (Hz)
 (to BS848) 95 89 86 85 82 78 73 65
 Includes +4dB fan in casework adjustment
 Drive guards fitted? YES
 Suitable for inverters? YES
 Isolator fitted? YES
 Standby motor fitted? YES
 Thermistors fitted? YES
 1No spare set of belts

**Hygroscopic Thermal Wheel Single Piece
 Recirculation Damper**

Air Volume 3.42 m³/s

Extract Air Outlet Damper

Damper (Damper Seals:- Side & Blade)
 Air Volume 3.8 m³/s

Approximate weight of unit 4814 kg

Reference British Museum - WCEC
AHU Reference AHU/05/05 Level 5 Supply & Extract
Unit Dimensions 1800W x 2565H x 7550L (mm) including 165 base
 The overall unit height shown above includes the base and roof, if fitted. However, overall unit dimensions exclude any externally fitted components such as spigots, dampers, louvres or cowls.

BASIC UNIT INFORMATION

Model Ref MA50/6/S
 Quantity 1
 Location Internal

SUPPLY SIDE

Volume 3.85 m³/s
 External static 300 Pa

EXTRACT SIDE

Volume 3.85 m³/s
 External static 300 Pa

COMPONENTS (In direction of airflow)**SUPPLY SIDE**

Supply Air Inlet Damper
 Recirculation Damper
 Panel Filters
 Bag Filters
 Hygroscopic Thermal Wheel Single Piece
 CW Cooler
 Service Access Section
 LPHW Heater
 Service Access Section
 Space For A Future Humidifier
 Supply Fan - Internal Run Only Motor

EXTRACT SIDE

Panel Filters
 Extract Fan - Internal Run Only Motor
 Diffuser
 Hygroscopic Thermal Wheel Single Piece
 Spacer Section
 Recirculation Damper
 Extract Air Outlet Damper

SEE SEPARATE UNIT SKETCH**TECHNICAL DATA**

Note:- The following information is provided as a guide only and must be checked at time of order

Supply Air Inlet Damper

Damper (Damper Seals:- Side & Blade)
 Air Volume 3.85 m³/s

Recirculation Damper

Damper (Damper Seals:- Side & Blade)
 Air Volume 3.465 m³/s

Panel Filters

Type Panel
 Efficiency G4
 Arrangement 2.5W x 1.5H
 Withdrawal Front
 Manometer Inclined
 1No Set of spare filter media

Bag Filters

Type Bag
 Efficiency F9
 Arrangement 2.5W x 1.5H
 Withdrawal Front
 Manometer Inclined
 1No Set of spare filter media

Hygroscopic Thermal Wheel Single Piece

Type Hygroscopic
 Conditions Winter Summer
 Supply Air On -4 °C 28 °C
 Supply Air Off 14 °C 25.9 °C
 Extract Air On Db 22 °C 25 °C
 Extract Air On RH 50 % 50 %
 Efficiency (Sup) 69.0 % 70.0 %
 Heat Recovered 119 kW 15 kW
 Special Features Speed control

Continued ...

CW Cooler

Volume 3.85 m³/s
 Air On Coil Db 30 °C
 Air On Coil Wb 20 °C
 Air Off Coil Db 11.85 °C
 Air Off Coil Wb 11.2 °C
 Duty 115.71 kW
 Face velocity 2.9 m/s
 Medium Chilled Water
 Flow Temp 5 °C
 Return Temp 11 °C
 Flow Rate 4.59 l/s
 Water Pd 17 KPa
 Rows/Fins 7R/8F
 No of Sections 1
 Construction Copper/Aluminium
 Eliminators YES
 Drain Pan Fixed

LPHW Heater

Volume 3.85 m³/s
 Air On Coil Db 5 °C
 Air Off Coil Db 26 °C
 Duty 97.5 kW
 Face velocity 3 m/s
 Medium LTHW
 Flow Temp 80 °C
 Return Temp 50 °C
 Flow Rate 1.14 l/s
 Water Pd 1 KPa
 Rows/Fins 2R/10F
 No of Sections 1
 Construction Copper/Aluminium

Space For A Future Humidifier**Supply Fan - Internal Run Only Motor**

Volume 3.85 m³/s
 External static 300 Pa
 Total static 1358 Pa
 Absorbed power 6.7 kW
 Motor power 11 kW (IE2)
 Motor type Standard/Single Speed
 Motor position Face on
 Fan type DIDW / Backward curved / Belt driven
 Fan speed 1826 RPM
 Outlet velocity 9.55 m/s
 Total fan efficiency 81.0 %
 Electrical Supply 400V-3Ph-50Hz
 Fan discharge SWL levels 63 125 250 500 1000 2000 4000 8000 (Hz)
 (to BS848) 98 92 89 88 85 81 76 68
 Includes +4dB fan in casework adjustment
 Drive guards fitted? YES
 Suitable for inverters? YES
 Isolator fitted? YES
 Standby motor fitted? NO
 Thermistors fitted? YES
 1No spare set of belts

Panel Filters

Type Panel
 Efficiency G4
 Arrangement 2.5W x 1.5H
 Withdrawal Side
 Manometer Inclined
 1No Set of spare filter media

Continued ...

Extract Fan - Internal Run Only Motor

Volume 3.85 m³/s
 External static 300 Pa
 Total static 855 Pa
 Absorbed power 4.34 kW
 Motor power 7.5 kW (IE2)
 Motor type Standard/Single Speed
 Motor position Face on
 Fan type DIDW / Backward curved / Belt driven
 Fan speed 1547 RPM
 Outlet velocity 9.55 m/s
 Total fan efficiency 81.0 %
 Electrical Supply 400V-3Ph-50Hz
 Fan discharge SWL levels 63 125 250 500 1000 2000 4000 8000 (Hz)
 (to BS848) 95 89 86 85 82 78 73 65
 Includes +4dB fan in casework adjustment
 Drive guards fitted? YES
 Suitable for inverters? YES
 Isolator fitted? YES
 Standby motor fitted? NO
 Thermistors fitted? YES
 1No spare set of belts

Hygroscopic Thermal Wheel Single Piece Recirculation Damper

Air Volume 3.465 m³/s

Extract Air Outlet Damper

Damper (Damper Seals:- Side & Blade)
 Air Volume 3.85 m³/s

Approximate weight of unit 4598 kg

Reference British Museum - WCEC
AHU Reference AHU/05/06 Level 5 Supply & Extract
Unit Dimensions 1850W x 2715H x 7750L (mm) including 165 base
 The overall unit height shown above includes the base and roof, if fitted. However, overall unit dimensions exclude any externally fitted components such as spigots, dampers, louvres or cowls.

BASIC UNIT INFORMATION

Model Ref MA50/6/S
 Quantity 1
 Location Internal

SUPPLY SIDE

Volume 4 m³/s
 External static 300 Pa

EXTRACT SIDE

Volume 4 m³/s
 External static 300 Pa

COMPONENTS (In direction of airflow)**SUPPLY SIDE**

Supply Air Inlet Damper
 Recirculation Damper
 Panel Filters
 Bag Filters
 Hygroscopic Thermal Wheel Single Piece
 CW Cooler
 Service Access Section
 LPHW Heater
 Service Access Section
 Space For A Future Humidifier
 Supply Fan "Run & Standby Motors"

EXTRACT SIDE

Panel Filters
 Extract Fan "Run & Standby Motors"
 Diffuser
 Hygroscopic Thermal Wheel Single Piece
 Spacer Section
 Recirculation Damper
 Extract Air Outlet Damper

SEE SEPARATE UNIT SKETCH**TECHNICAL DATA**

Note:- The following information is provided as a guide only and must be checked at time of order

Supply Air Inlet Damper

Damper (Damper Seals:- Side & Blade)
 Air Volume 4 m³/s

Recirculation Damper

Damper (Damper Seals:- Side & Blade)
 Air Volume 3.6 m³/s

Panel Filters

Type Panel
 Efficiency G4
 Arrangement 2.5W x 2H
 Withdrawal Front
 Manometer Inclined
 1No Set of spare filter media

Bag Filters

Type Bag
 Efficiency F9
 Arrangement 2.5W x 2H
 Withdrawal Front
 Manometer Inclined
 1No Set of spare filter media

Hygroscopic Thermal Wheel Single Piece

Type	Hygroscopic	
Conditions	Winter	Summer
Supply Air On	-4 °C	28 °C
Supply Air Off	14.2 °C	25.9 °C
Extract Air On Db	22 °C	25 °C
Extract Air On RH	50 %	50 %
Efficiency (Sup)	70.0 %	71.0 %
Heat Recovered	125 kW	15 kW
Special Features	Speed control	

Continued ...

CW Cooler

Volume 4 m³/s
 Air On Coil Db 30 °C
 Air On Coil Wb 20 °C
 Air Off Coil Db 11.85 °C
 Air Off Coil Wb 11.2 °C
 Duty 120.22 kW
 Face velocity 2.8 m/s
 Medium Chilled Water
 Flow Temp 5 °C
 Return Temp 11 °C
 Flow Rate 4.77 l/s
 Water Pd 18 KPa
 Rows/Fins 7R/8F
 No of Sections 1
 Construction Copper/Aluminium
 Eliminators YES
 Drain Pan Fixed

LPHW Heater

Volume 4 m³/s
 Air On Coil Db 5 °C
 Air Off Coil Db 26 °C
 Duty 101.3 kW
 Face velocity 2.8 m/s
 Medium LTHW
 Flow Temp 80 °C
 Return Temp 50 °C
 Flow Rate 0.82 l/s
 Water Pd 8 KPa
 Rows/Fins 2R/8F
 No of Sections 1
 Construction Copper/Aluminium

Space For A Future Humidifier**Supply Fan "Run & Standby Motors"**

Volume 4 m³/s
 External static 300 Pa
 Total static 1279 Pa
 Absorbed power 6.57 kW
 Motor power 11 kW (IE2)
 Motor type Standard/Single Speed
 Motor position Face on
 Fan type DIDW / Backward curved / Belt driven
 Fan speed 1800 RPM
 Outlet velocity 9.92 m/s
 Total fan efficiency 82.0 %
 Electrical Supply 400V-3Ph-50Hz
 Fan discharge SWL levels 63 125 250 500 1000 2000 4000 8000 (Hz)
 (to BS848) 98 92 89 88 85 81 76 68
 Includes +4dB fan in casework adjustment
 Drive guards fitted? YES
 Suitable for inverters? YES
 Isolator fitted? YES
 Standby motor fitted? YES
 Thermistors fitted? YES
 1No spare set of belts

Panel Filters

Type Panel
 Efficiency G4
 Arrangement 2.5W x 1.5H
 Withdrawal Side
 Manometer Inclined
 1No Set of spare filter media

Continued ...

Extract Fan "Run & Standby Motors"

Volume 4 m³/s
 External static 300 Pa
 Total static 876 Pa
 Absorbed power 4.67 kW
 Motor power 7.5 kW (IE2)
 Motor type Standard/Single Speed
 Motor position Face on
 Fan type DIDW / Backward curved / Belt driven
 Fan speed 1582 RPM
 Outlet velocity 9.92 m/s
 Total fan efficiency 80.0 %
 Electrical Supply 400V-3Ph-50Hz
 Fan discharge SWL levels 63 125 250 500 1000 2000 4000 8000 (Hz)
 (to BS848) 96 90 87 86 83 79 74 66
 Includes +4dB fan in casework adjustment
 Drive guards fitted? YES
 Suitable for inverters? YES
 Isolator fitted? YES
 Standby motor fitted? YES
 Thermistors fitted? YES
 1No spare set of belts

**Hygroscopic Thermal Wheel Single Piece
 Recirculation Damper**

Air Volume 3.6 m³/s

Extract Air Outlet Damper

Damper (Damper Seals:- Side & Blade)
 Air Volume 4 m³/s

Approximate weight of unit 4964 kg

Reference British Museum - WCEC
AHU Reference AHU/05/08 Level 5 Supply & Extract
Unit Dimensions 1950W x 2715H x 7900L (mm) including 165 base
 The overall unit height shown above includes the base and roof, if fitted. However, overall unit dimensions exclude any externally fitted components such as spigots, dampers, louvres or cowls.

BASIC UNIT INFORMATION

Model Ref MA50/6/S
 Quantity 1
 Location Internal

SUPPLY SIDE

Volume 4.6 m³/s
 External static 300 Pa

EXTRACT SIDE

Volume 4.6 m³/s
 External static 300 Pa

COMPONENTS (In direction of airflow)**SUPPLY SIDE**

Supply Air Inlet Damper
 Recirculation Damper
 Panel Filters
 Bag Filters
 Hygroscopic Thermal Wheel Single Piece
 CW Cooler
 Service Access Section
 LPHW Heater
 Service Access Section
 Space For A Future Humidifier
 Supply Fan - "Run & Standby Motors"

EXTRACT SIDE

Panel Filters
 Extract Fan "Run & Standby Motors"
 Diffuser
 Hygroscopic Thermal Wheel Single Piece
 Spacer Section
 Recirculation Damper
 Extract Air Outlet Damper

SEE SEPARATE UNIT SKETCH**TECHNICAL DATA**

Note:- The following information is provided as a guide only and must be checked at time of order

Supply Air Inlet Damper

Damper (Damper Seals:- Side & Blade)
 Air Volume 4.6 m³/s

Recirculation Damper

Damper (Damper Seals:- Side & Blade)
 Air Volume 4.14 m³/s

Panel Filters

Type Panel
 Efficiency G4
 Arrangement 3W x 2H
 Withdrawal Front
 Manometer Inclined
 1No Set of spare filter media

Bag Filters

Type Bag
 Efficiency F9
 Arrangement 3W x 2H
 Withdrawal Front
 Manometer Inclined
 1No Set of spare filter media

Hygroscopic Thermal Wheel Single Piece

Type	Hygroscopic	
Conditions	Winter	Summer
Supply Air On	-4 °C	28 °C
Supply Air Off	13.9 °C	25.9 °C
Extract Air On Db	22 °C	25 °C
Extract Air On RH	50 %	50 %
Efficiency (Sup)	69.0 %	70.0 %
Heat Recovered	141 kW	17 kW
Special Features	Speed control	

Continued ...

CW Cooler

Volume 4.6 m³/s
 Air On Coil Db 30 °C
 Air On Coil Wb 20 °C
 Air Off Coil Db 11.9 °C
 Air Off Coil Wb 11.2 °C
 Duty 138.25 kW
 Face velocity 2.9 m/s
 Medium Chilled Water
 Flow Temp 5 °C
 Return Temp 11 °C
 Flow Rate 5.48 l/s
 Water Pd 21 KPa
 Rows/Fins 7R/8F
 No of Sections 1
 Construction Copper/Aluminium
 Eliminators YES
 Drain Pan Fixed

LPHW Heater

Volume 4.6 m³/s
 Air On Coil Db 5 °C
 Air Off Coil Db 26 °C
 Duty 116.5 kW
 Face velocity 3.1 m/s
 Medium LTHW
 Flow Temp 80 °C
 Return Temp 50 °C
 Flow Rate 0.95 l/s
 Water Pd 10 KPa
 Rows/Fins 2R/8F
 No of Sections 1
 Construction Copper/Aluminium

Space For A Future Humidifier**Supply Fan - "Run & Standby Motors"**

Volume 4.6 m³/s
 External static 300 Pa
 Total static 1322 Pa
 Absorbed power 8.03 kW
 Motor power 11 kW (IE2)
 Motor type Standard/Single Speed
 Motor position Face on
 Fan type DIDW / Backward curved / Belt driven
 Fan speed 1906 RPM
 Outlet velocity 11.41 m/s
 Total fan efficiency 81.0 %
 Electrical Supply 400V-3Ph-50Hz
 Fan discharge SWL levels 63 125 250 500 1000 2000 4000 8000 (Hz)
 (to BS848) 100 94 91 90 87 83 78 70
 Includes +4dB fan in casework adjustment
 Drive guards fitted? YES
 Suitable for inverters? YES
 Isolator fitted? YES
 Standby motor fitted? YES
 Thermistors fitted? YES
 1No spare set of belts

Panel Filters

Type Panel
 Efficiency G4
 Arrangement 3W x 1.5H
 Withdrawal Side
 Manometer Inclined
 1No Set of spare filter media

Continued ...

Extract Fan "Run & Standby Motors"

Volume 4.6 m³/s
 External static 300 Pa
 Total static 884 Pa
 Absorbed power 5.68 kW
 Motor power 7.5 kW (IE2)
 Motor type Standard/Single Speed
 Motor position Face on
 Fan type DIDW / Backward curved / Belt driven
 Fan speed 1679 RPM
 Outlet velocity 11.41 m/s
 Total fan efficiency 78.0 %
 Electrical Supply 400V-3Ph-50Hz
 Fan discharge SWL levels 63 125 250 500 1000 2000 4000 8000 (Hz)
 (to BS848) 94 89 87 88 86 82 77 68
 Includes +4dB fan in casework adjustment
 Drive guards fitted? YES
 Suitable for inverters? YES
 Isolator fitted? YES
 Standby motor fitted? YES
 Thermistors fitted? YES
 1No spare set of belts

**Hygroscopic Thermal Wheel Single Piece
 Recirculation Damper**

Air Volume 4.14 m³/s

Extract Air Outlet Damper

Damper (Damper Seals:- Side & Blade)
 Air Volume 4.6 m³/s

Approximate weight of unit 5264 kg

Michael J Lonsdale

**British Museum
World Conservation
Exhibition Centre - London**

**Revision 05 - Technical Submission
Air Handling Equipment**

**Section No 3
AHU Proposal Sketches**



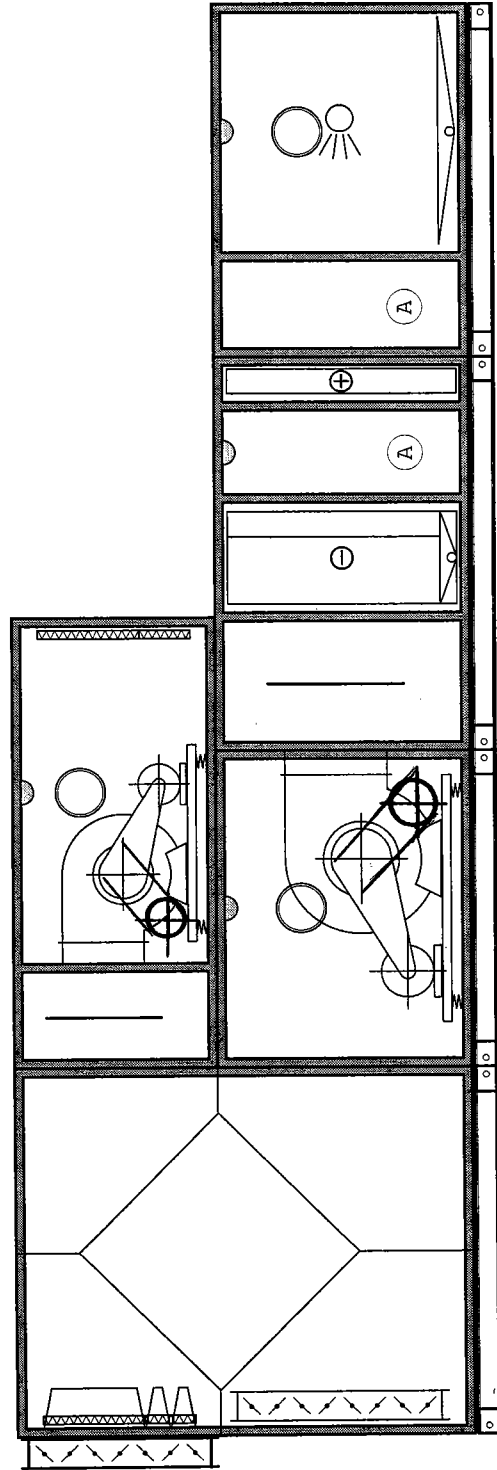

Quote Reference E090737U British Museum - WCEC
AHU Reference AHU B2/03 Building 5 Supply & Extract



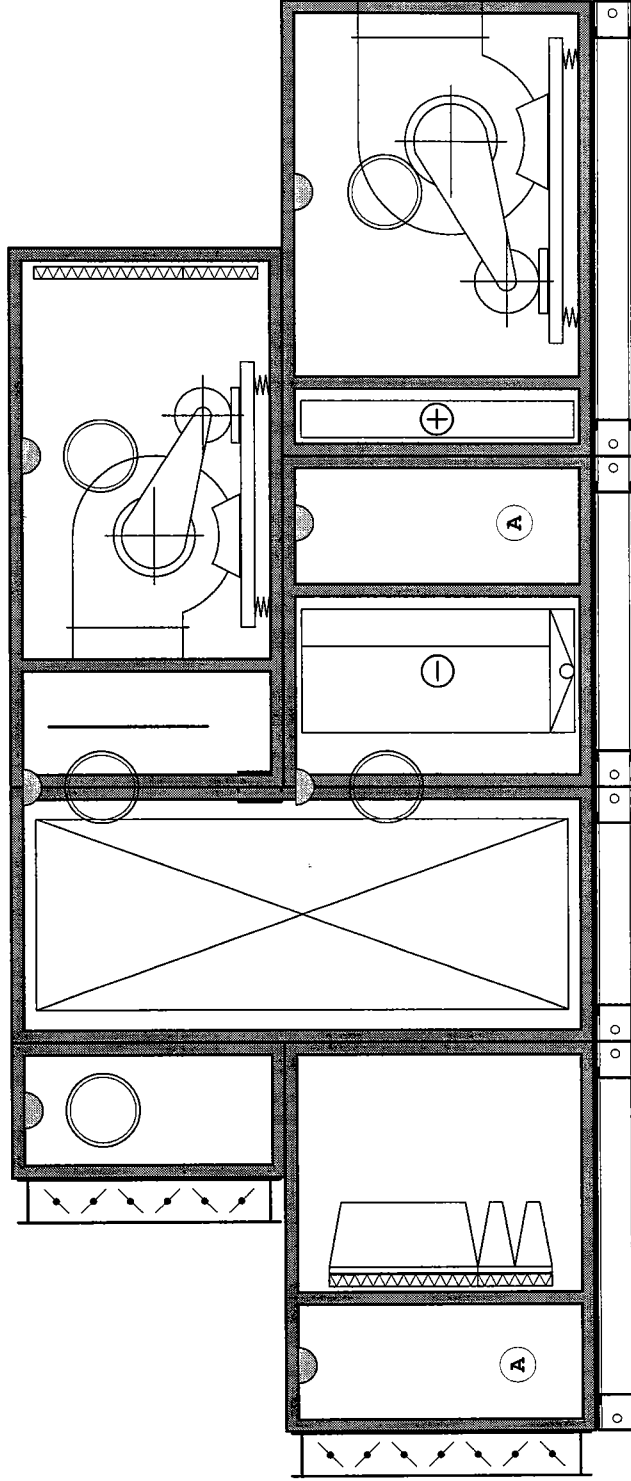

Quote Reference E090737U British Museum - WCEC
AHU Reference AHU/B2/04 B2 Plantroom

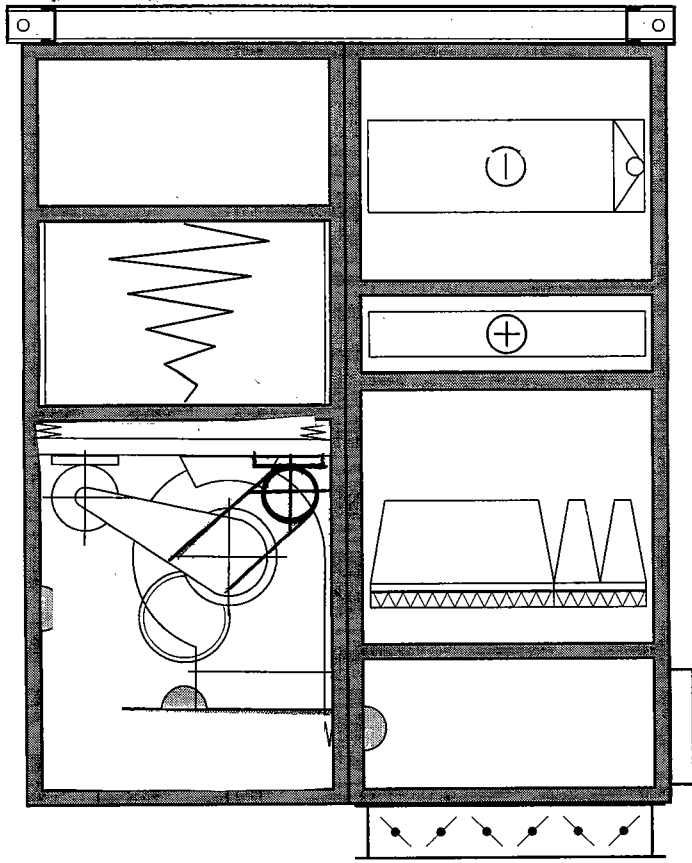

Quote Reference E090737U British Museum - WCEC
AHU Reference AHU B3/01,02,B2/01,02,B1/01,02 & 02/01



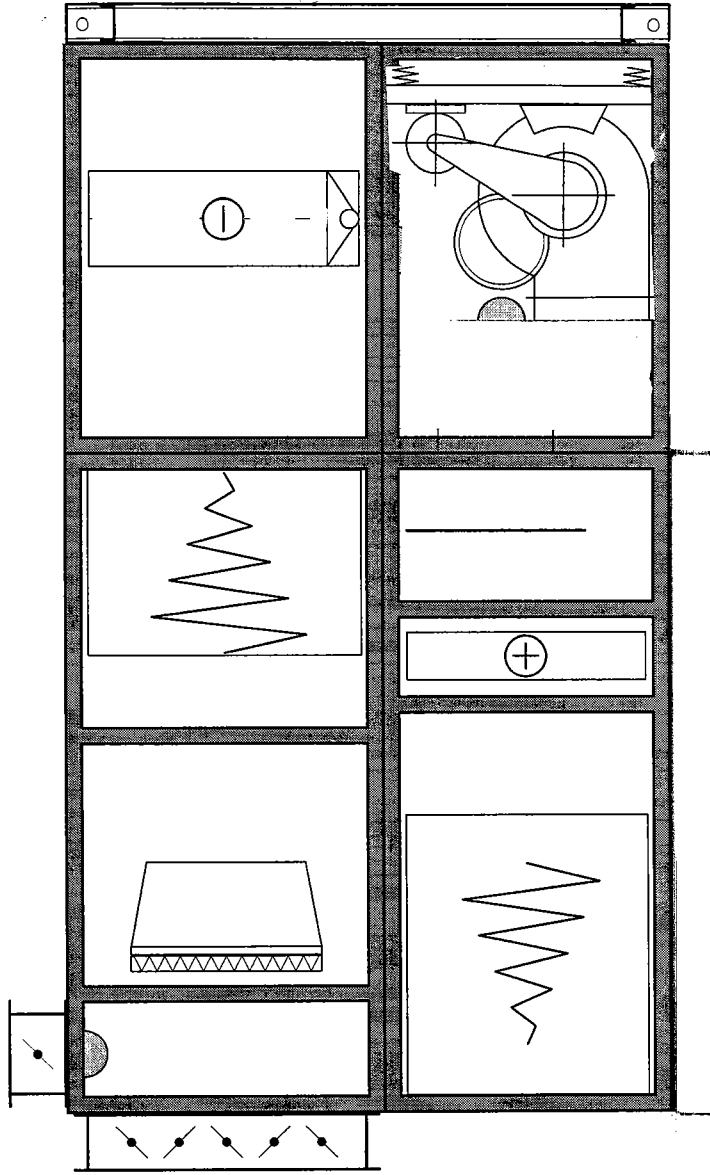

Quote Reference E090737U British Museum - WCEC
AHU Reference AHU/00/01 Photosuite Supply



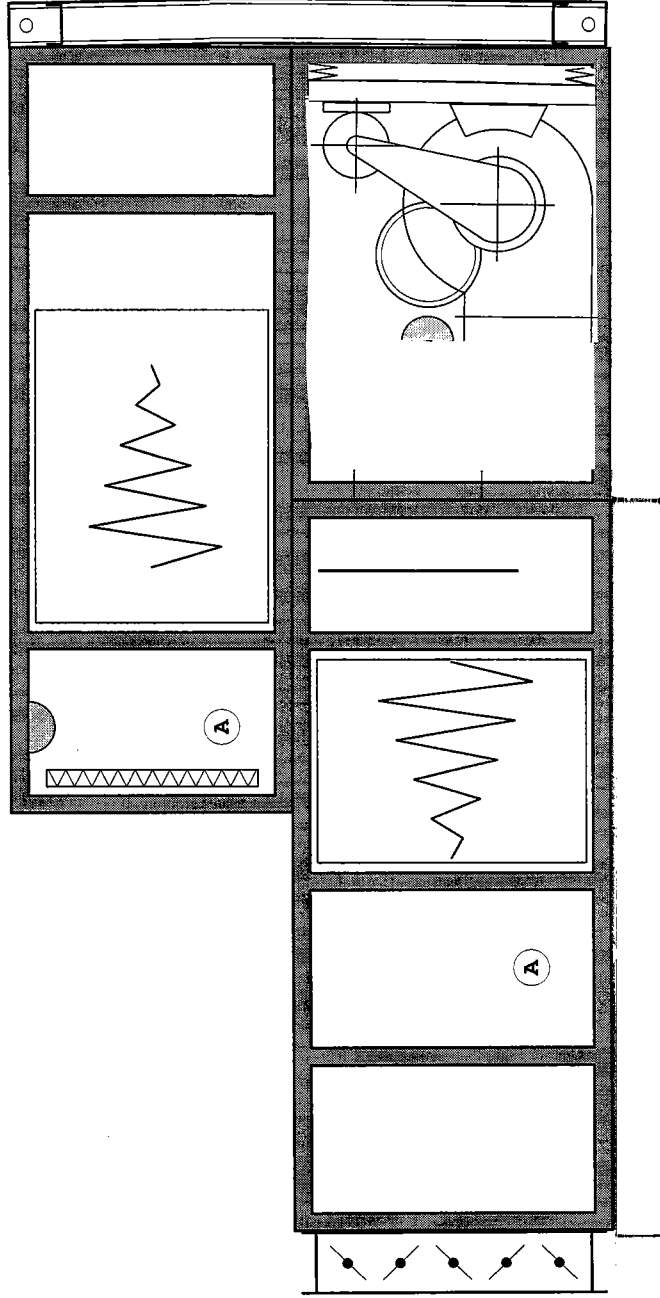

Quote Reference E090737U British Museum - WCEC
AHU Reference AHU/00/01 Photosuite Extract



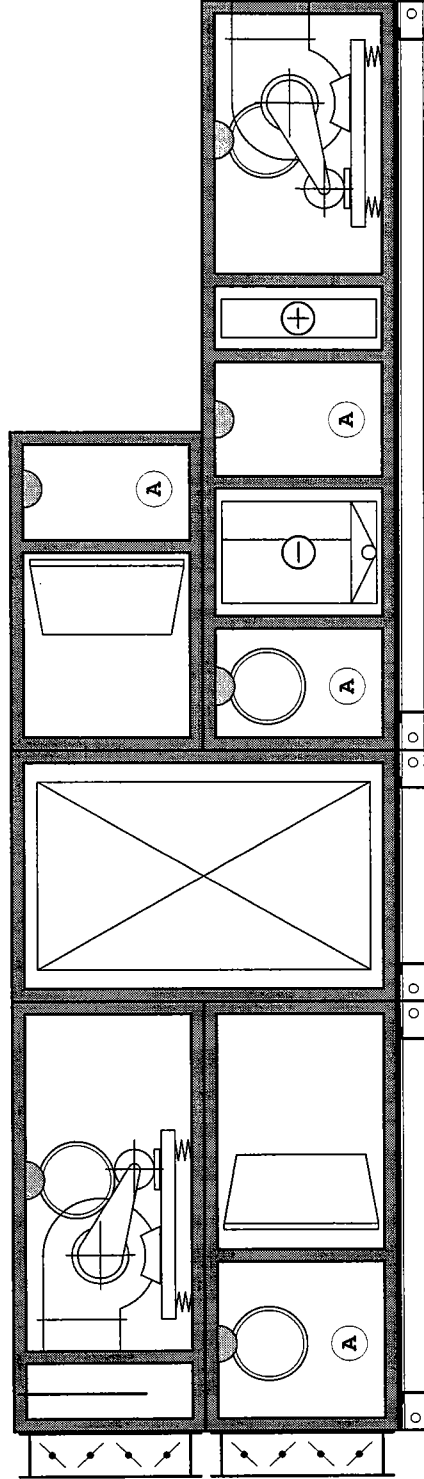

Quote Reference E090737U British Museum - WCEC
AHU Reference AHU/01/01 & AHU/01/02 Supply & Extract



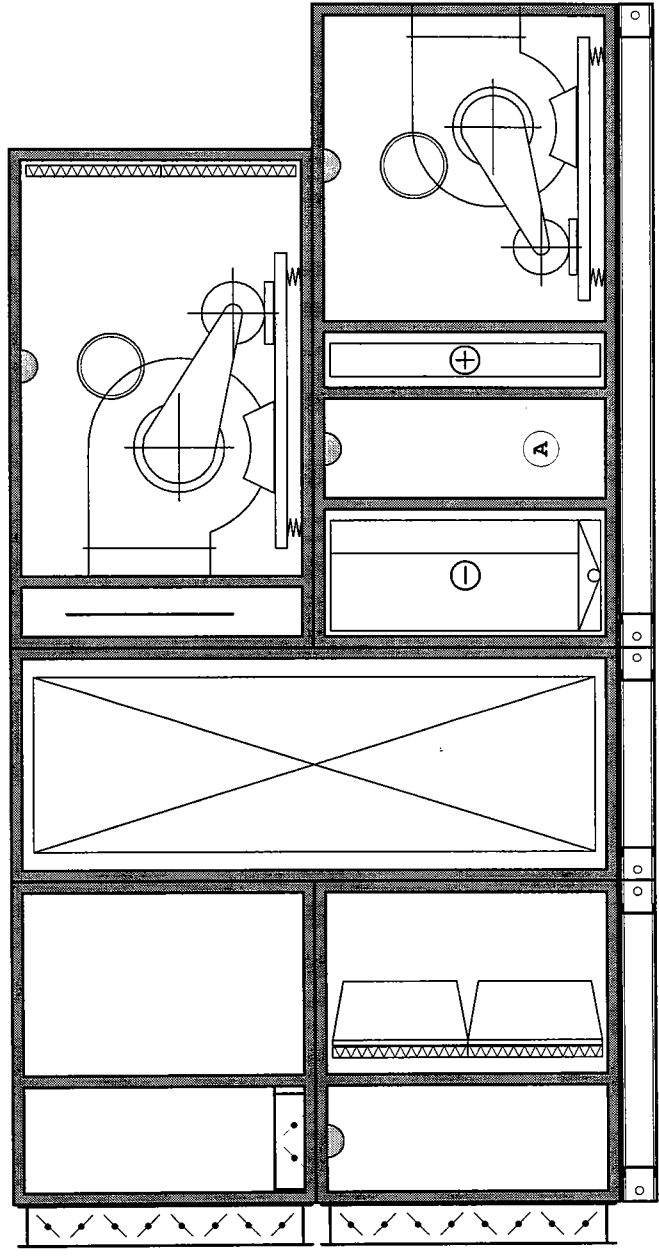

Quote Reference E090737U British Museum - WCEC
AHU Reference AHU/05/01 Level 5 Supply & Extract



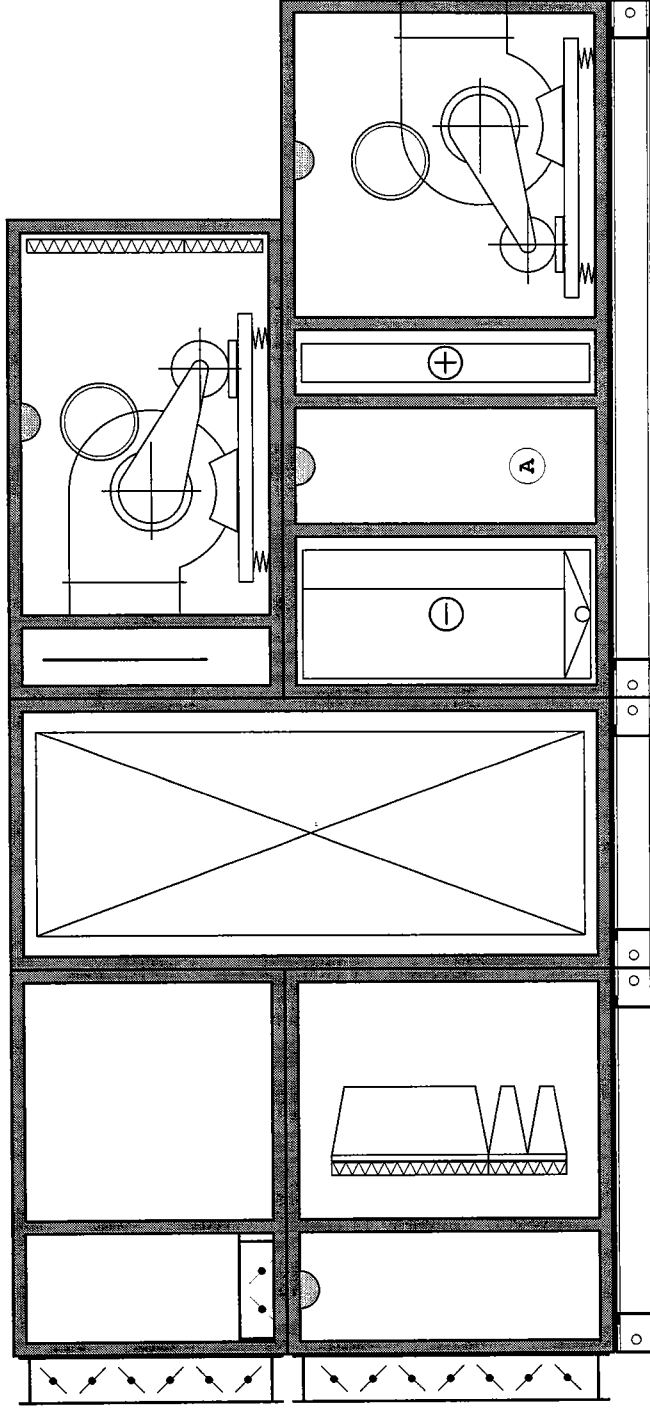

Quote Reference E090737U British Museum - WCEC
AHU Reference AHU/05/02 Level 5 Supply & Extract



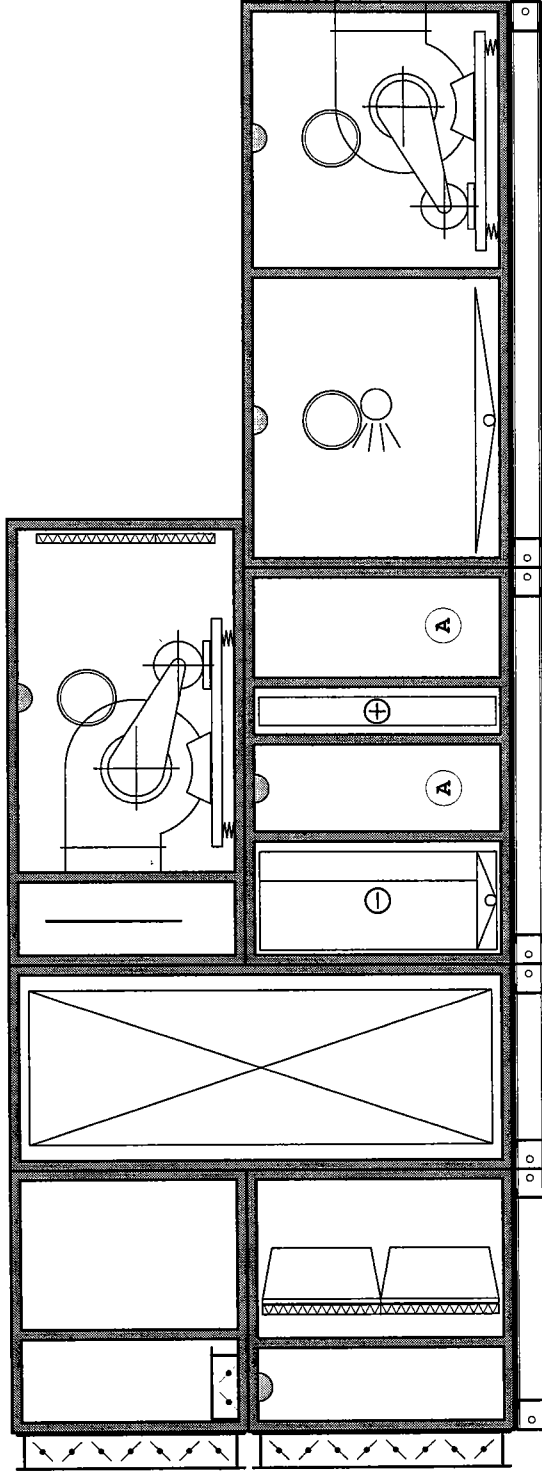

Quote Reference E090737U British Museum - WCEC
AHU Reference AHU/05/03 & 07 Level 5 Supply & Extract



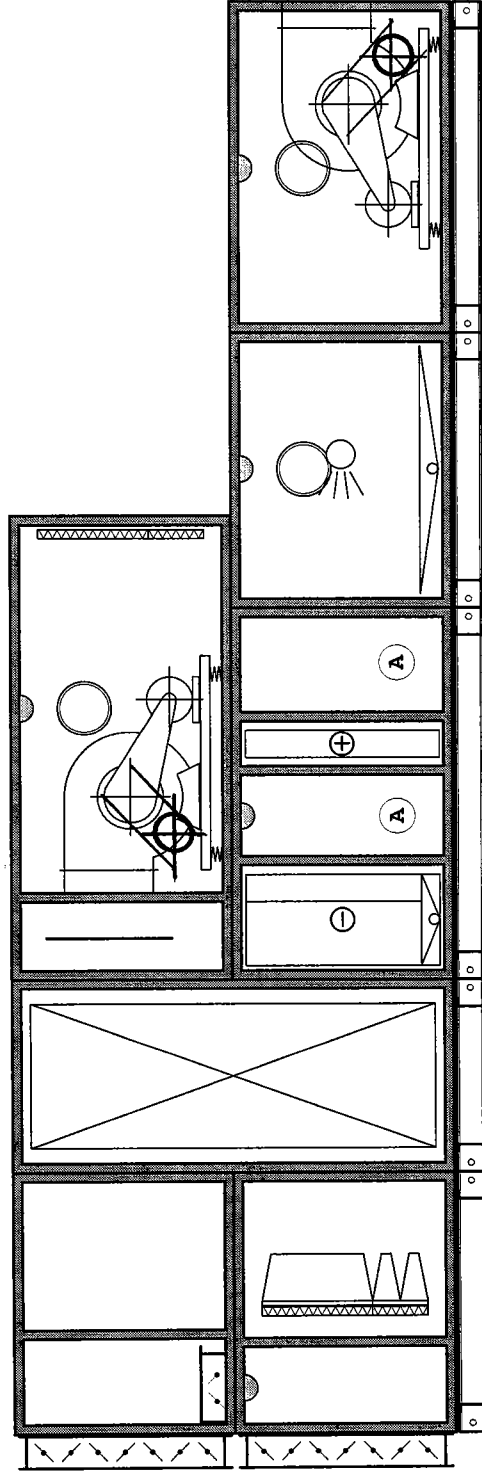

Quote Reference E090737U British Museum - WCEC
AHU Reference AHU/05/04 Level 5 Supply & Extract

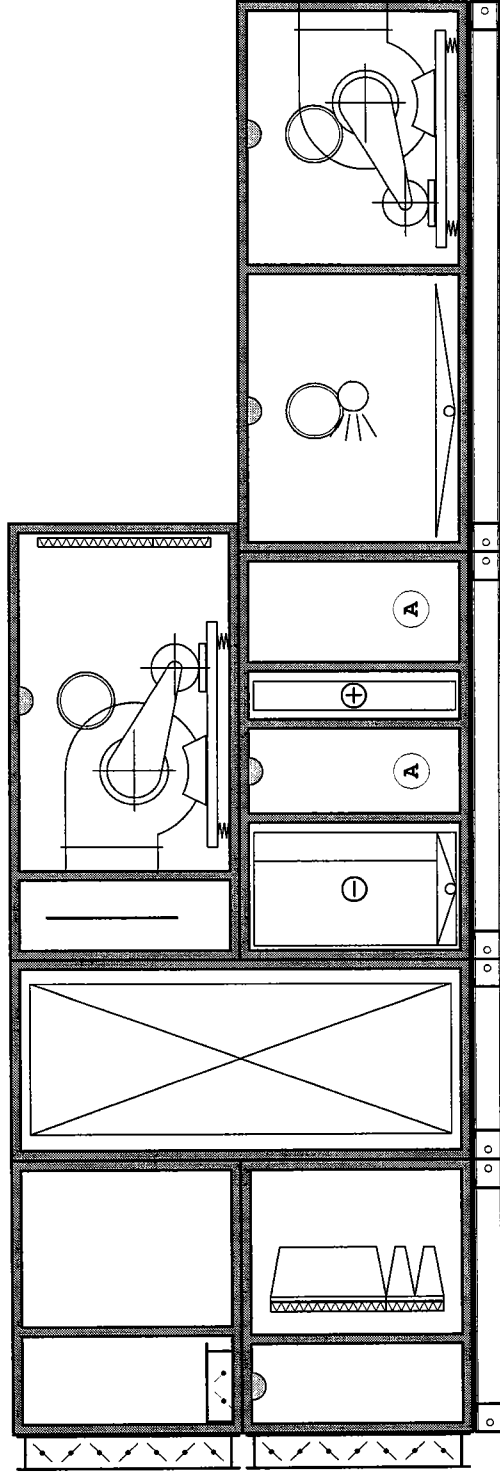

Quote Reference E090737U British Museum - WCEC
AHU Reference AHU/05/05 Level 5 Supply & Extract



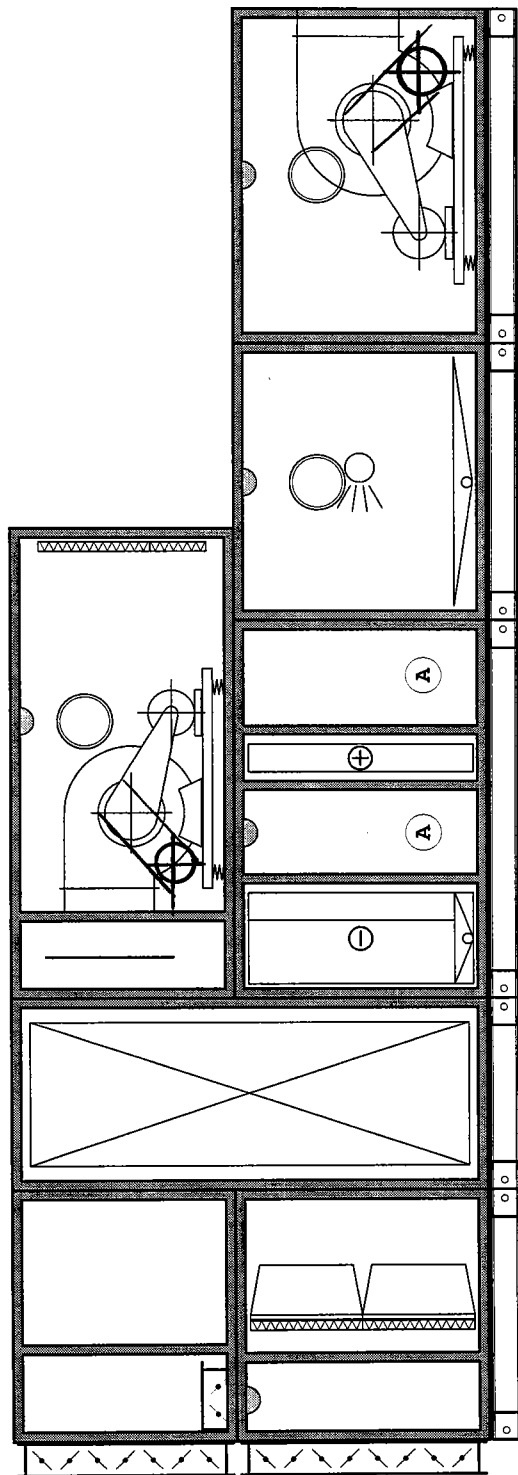

Quote Reference E090737U British Museum - WCEC
AHU Reference AHU/05/06 Level 5 Supply & Extract

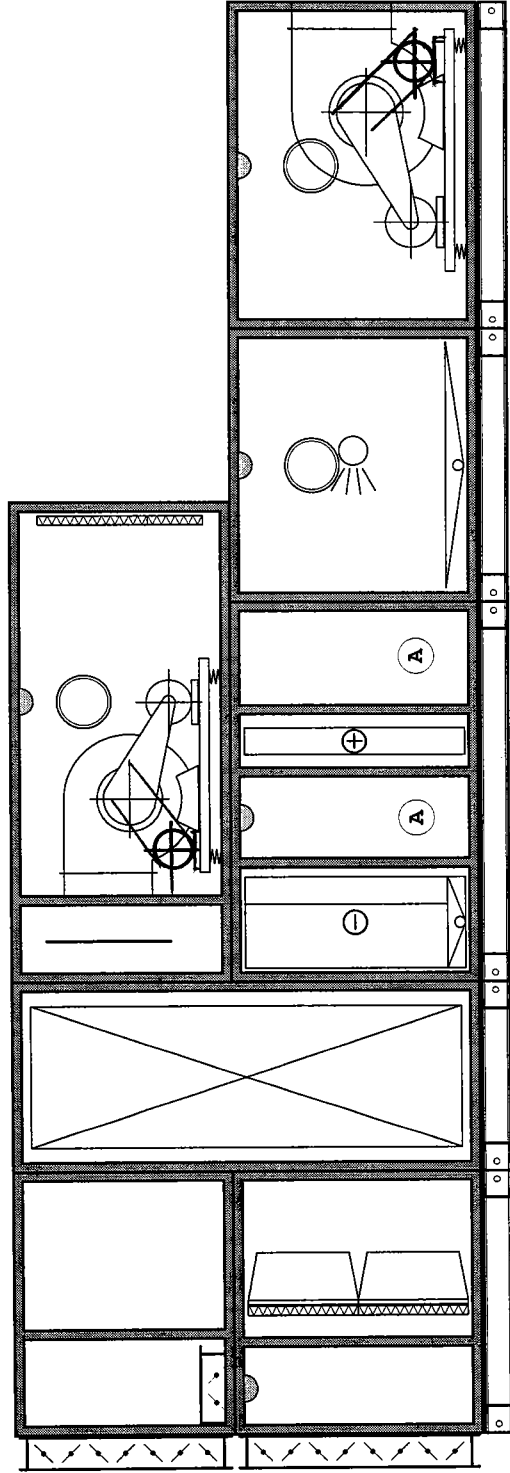

Quote Reference E090737U British Museum - WCEC
AHU Reference AHU/05/08 Level 5 Supply & Extract



AHU Overall Size - 1350mm (W) x 2790mm (H) (Inc base & damper) x 2100mm (L)

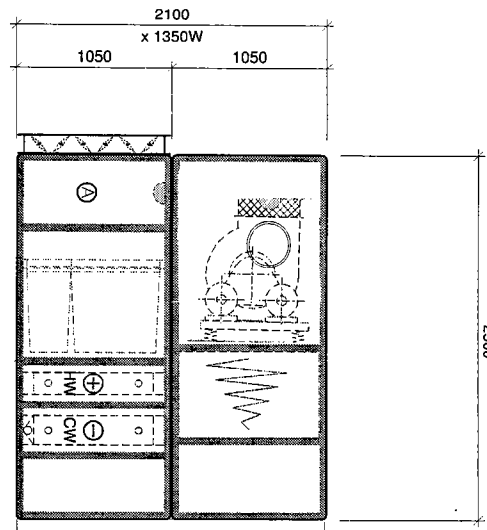

Elevation

	Project Reference:	British Museum - WCEC - Rev U	Date:	07/06/12	Supply Volume & External Static:	1.9m ³ /s @ 250Pa	Notes:	Drawing Scale:	1:50
	Unit Reference:	AHU B3/01,02, B2/01,02, B1/01, 02 & 02/01	Model Reference:	MA50/2/S	Extract Volume:	N/A		Drawing Number:	E090737U/1

Michael J Lonsdale

**British Museum
World Conservation
Exhibition Centre - London**

**Revision 05 - Technical Submission
Air Handling Equipment**

**Section No 4
AHU Fan Curves**



Customer : **MJL**
Reference : **British Museum - WCEC**
Item No : **AHU/B3/01 & AHU/B1/02 Supply**

Date : **07.06.2012**
Made by : **Jim Picken**
Page : **1**

Technical data

... for fan: RZR 11-0315

Installation acc. to DIN 24 163 part 1	:	B
Flow rate (V)	:	1.60 m ³ /s
Total pressure (dpt)	:	929 Pa
Dyn. pressure (pd2) at discharge	:	59 Pa
Static pressure (dpfa)	:	870 Pa
Pressure losses (pv) at intake	:	0 Pa
Reference density (Rho1)	:	1.20 kg/m ³
Temperature t of the gas (t)	:	20 °C
Speed (n _v)	:	2595 1/min ^{1.)}
Power on shaft (Pw)	:	1.97 kW
Efficiency (ETA _t)	:	75 %
Fan weight	:	24 kg
A-Sound power level LwA _{4,7}	:	86 dB

1.) Fan speed tolerances of ±4% may occur when calculating the belt drive. This may cause technical data being slightly different to the values above.

unweighted	63 Hz	:	93/79 dB ^{2.)}
	125 Hz	:	87/82 dB
Octave sound power level	250 Hz	:	84/81 dB
acc. to discharge/intake	500 Hz	:	83/85 dB
LwOkt _{4,7} at	1000 Hz	:	80/80 dB
Octave band frequency	2000 Hz	:	76/77 dB
	4000 Hz	:	71/72 dB
	8000 Hz	:	63/65 dB

2.) The octave sound power levels can reach unpredictable higher values than calculated in the octave band of the blade passing frequencies.

... for motor: 100L-2

Size	:	100L-2
Speed	:	2890 rpm
Power	:	3 kW
Voltage/Frequency	:	400/690/50 V/Hz
Electric current	:	6.1/3.5 A

Customer : **MJL**
Reference : **British Museum - WCEC**
Item No : **AHU/B3/01 & AHU/B1/02 Supply**

Date : **07.06.2012**
Made by : **Jim Picken**
Page : **2**

Fan curves: RZR 11-0315

Basis:

Reference density (Rho1) : 1.20 kg/m³
Install: B

Total pressure [Pa]

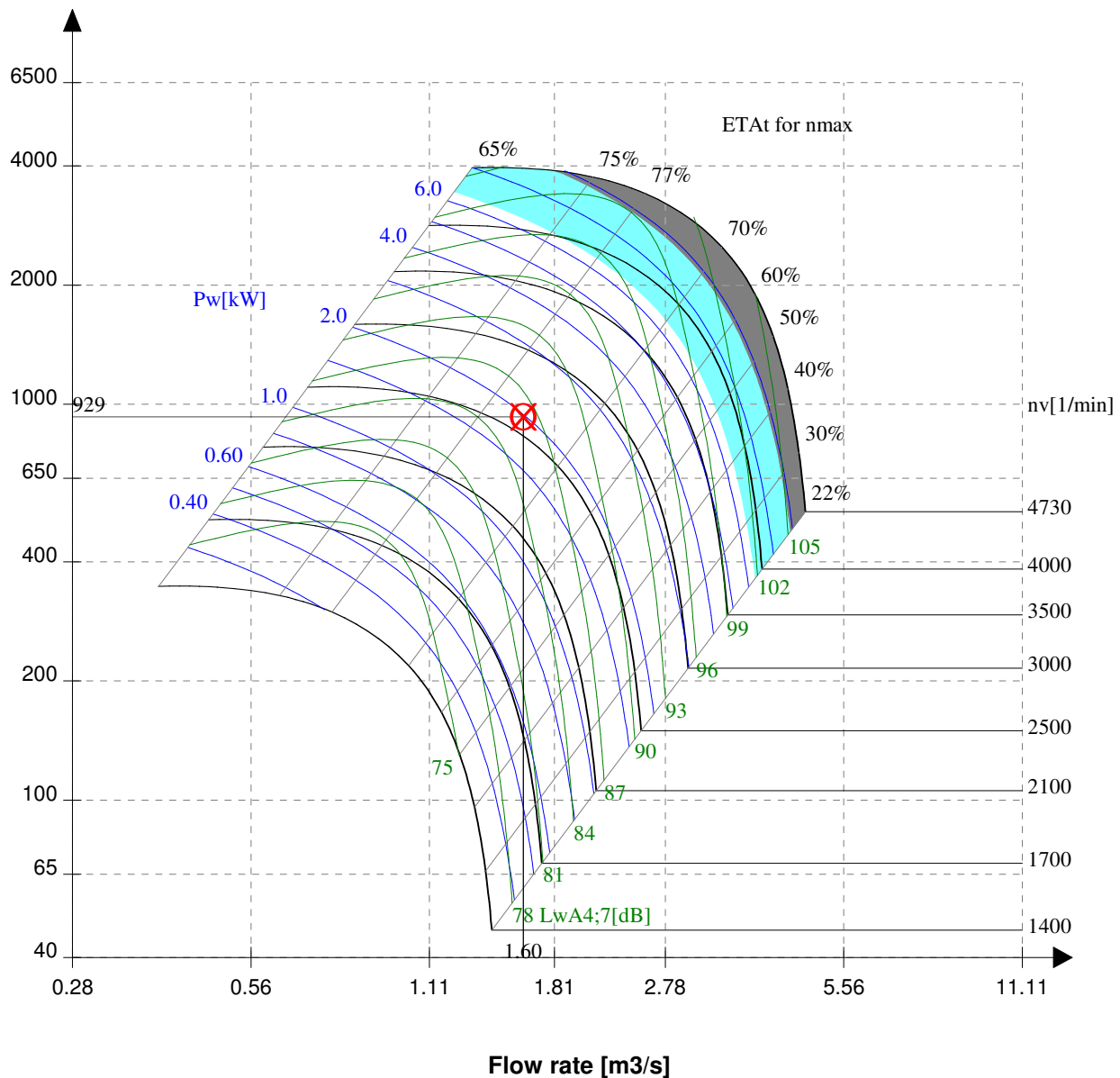

- RZR 19- ... only
- Do not use in this area

Customer : **MJL**
Reference : **British Museum - WCEC**
Item No : **AHU/B3/02 Supply**

Date : **07.06.2012**
Made by : **Jim Picken**
Page : **1**

Technical data

... for fan: RZR 11-0315

Installation acc. to DIN 24 163 part 1	:	B
Flow rate (V)	:	1.30 m ³ /s
Total pressure (dpt)	:	869 Pa
Dyn. pressure (pd2) at discharge	:	39 Pa
Static pressure (dpfa)	:	830 Pa
Pressure losses (pv) at intake	:	0 Pa
Reference density (Rho1)	:	1.20 kg/m ³
Temperature t of the gas (t)	:	20 °C
Speed (n _v)	:	2390 1/min ^{1.)}
Power on shaft (Pw)	:	1.49 kW
Efficiency (ETA _t)	:	76 %
Fan weight	:	24 kg
A-Sound power level LwA _{4,7}	:	83 dB

1.) Fan speed tolerances of ±4% may occur when calculating the belt drive. This may cause technical data being slightly different to the values above.

unweighted	63 Hz	:	90/76 dB ^{2.)}
	125 Hz	:	84/79 dB
Octave sound power level	250 Hz	:	81/78 dB
acc. to discharge/intake	500 Hz	:	80/82 dB
LwOkt _{4,7} at	1000 Hz	:	77/77 dB
Octave band frequency	2000 Hz	:	73/74 dB
	4000 Hz	:	68/69 dB
	8000 Hz	:	60/62 dB

2.) The octave sound power levels can reach unpredictable higher values than calculated in the octave band of the blade passing frequencies.

... for motor: 90L-2

Size	:	90L-2
Speed	:	2880 rpm
Power	:	2,2 kW
Voltage/Frequency	:	230/400/50 V/Hz
Electric current	:	7.9/4.55 A

Customer : **MJL**
Reference : **British Museum - WCEC**
Item No : **AHU/B3/02 Supply**

Date : **07.06.2012**
Made by : **Jim Picken**
Page : **2**

Fan curves: RZR 11-0315

Basis:

Reference density (Rho1) : 1.20 kg/m³
Install: B

Total pressure [Pa]

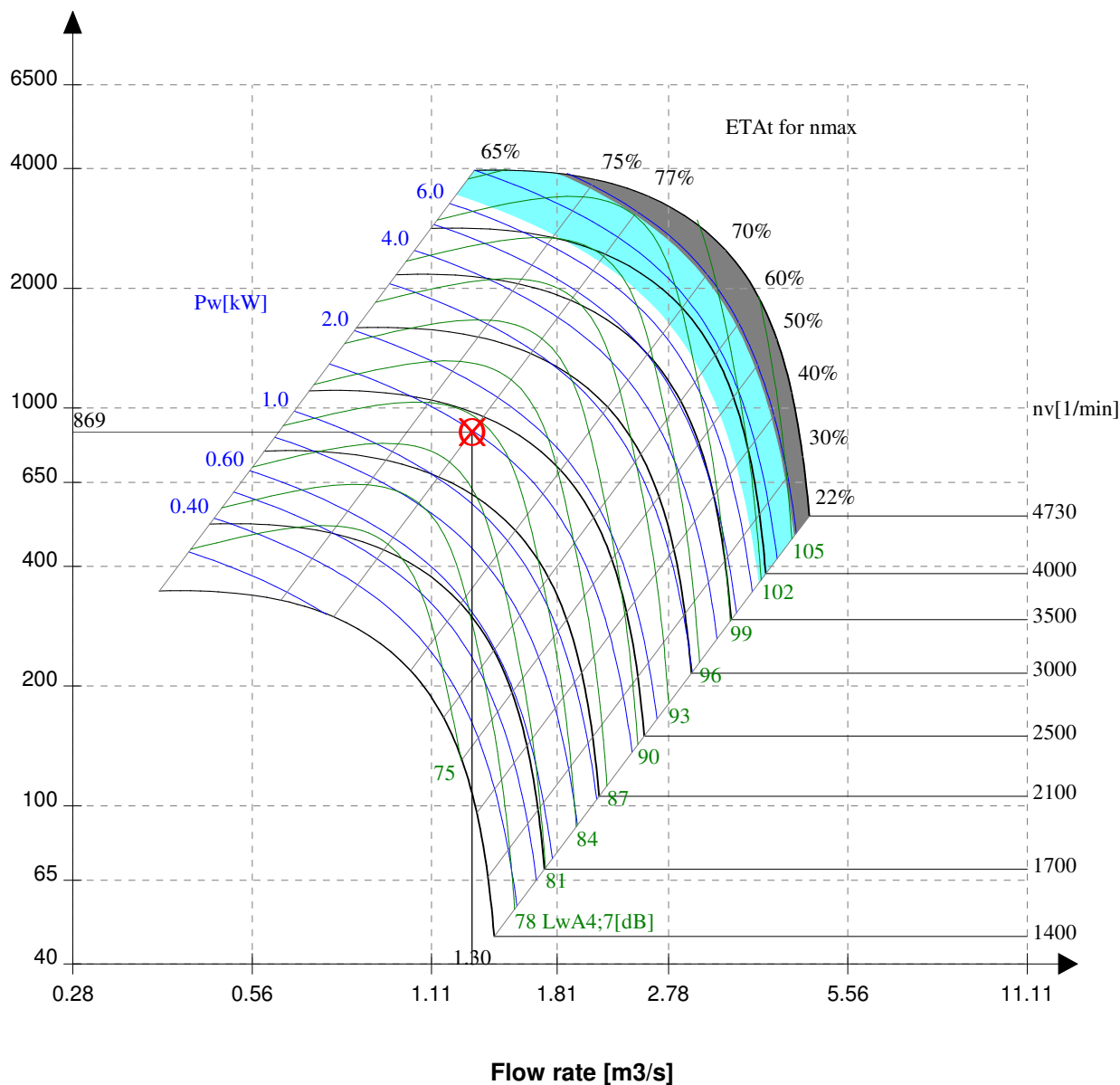

- RZR 19- ... only
- Do not use in this area

Customer : **MJL**
Reference : **British Museum - WCEC**
Item No : **AHU/B2/01 & AHU/B1/01 Supply**

Date : **06.06.2012**
Made by : **Jim Picken**
Page : **1**

Technical data

... for fan: RZR 11-0315

Installation acc. to DIN 24 163 part 1	:	B
Flow rate (V)	:	1.90 m ³ /s
Total pressure (dpt)	:	1014 Pa
Dyn. pressure (pd ₂) at discharge	:	84 Pa
Static pressure (dpfa)	:	930 Pa
Pressure losses (pv) at intake	:	0 Pa
Reference density (Rho ₁)	:	1.20 kg/m ³
Temperature t of the gas (t)	:	20 °C
Speed (n _v)	:	2834 1/min ^{1.)}
Power on shaft (Pw)	:	2.62 kW
Efficiency (ETA _t)	:	73 %
Fan weight	:	24 kg
A-Sound power level LwA _{4,7}	:	89 dB

1.) Fan speed tolerances of ±4% may occur when calculating the belt drive. This may cause technical data being slightly different to the values above.

unweighted	63 Hz	:	92/79 dB ^{2.)}
	125 Hz	:	87/82 dB
Octave sound power level	250 Hz	:	85/81 dB
acc. to discharge/intake	500 Hz	:	86/88 dB
LwOkt _{4,7} at	1000 Hz	:	84/84 dB
Octave band frequency	2000 Hz	:	80/81 dB
	4000 Hz	:	75/76 dB
	8000 Hz	:	66/68 dB

2.) The octave sound power levels can reach unpredictable higher values than calculated in the octave band of the blade passing frequencies.

... for motor: 112M-2

Size	:	112M-2
Speed	:	2905 rpm
Power	:	4 kW
Voltage/Frequency	:	400/690/50 V/Hz
Electric current	:	7.8/4.5 A

Customer : **MJL**
Reference : **British Museum - WCEC**
Item No : **AHU/B2/01 & AHU/B1/01 Supply**

Date : **06.06.2012**
Made by : **Jim Picken**
Page : **2**

Fan curves: RZR 11-0315

Basis:

Reference density (Rho1) : 1.20 kg/m³
Install: B

Total pressure [Pa]

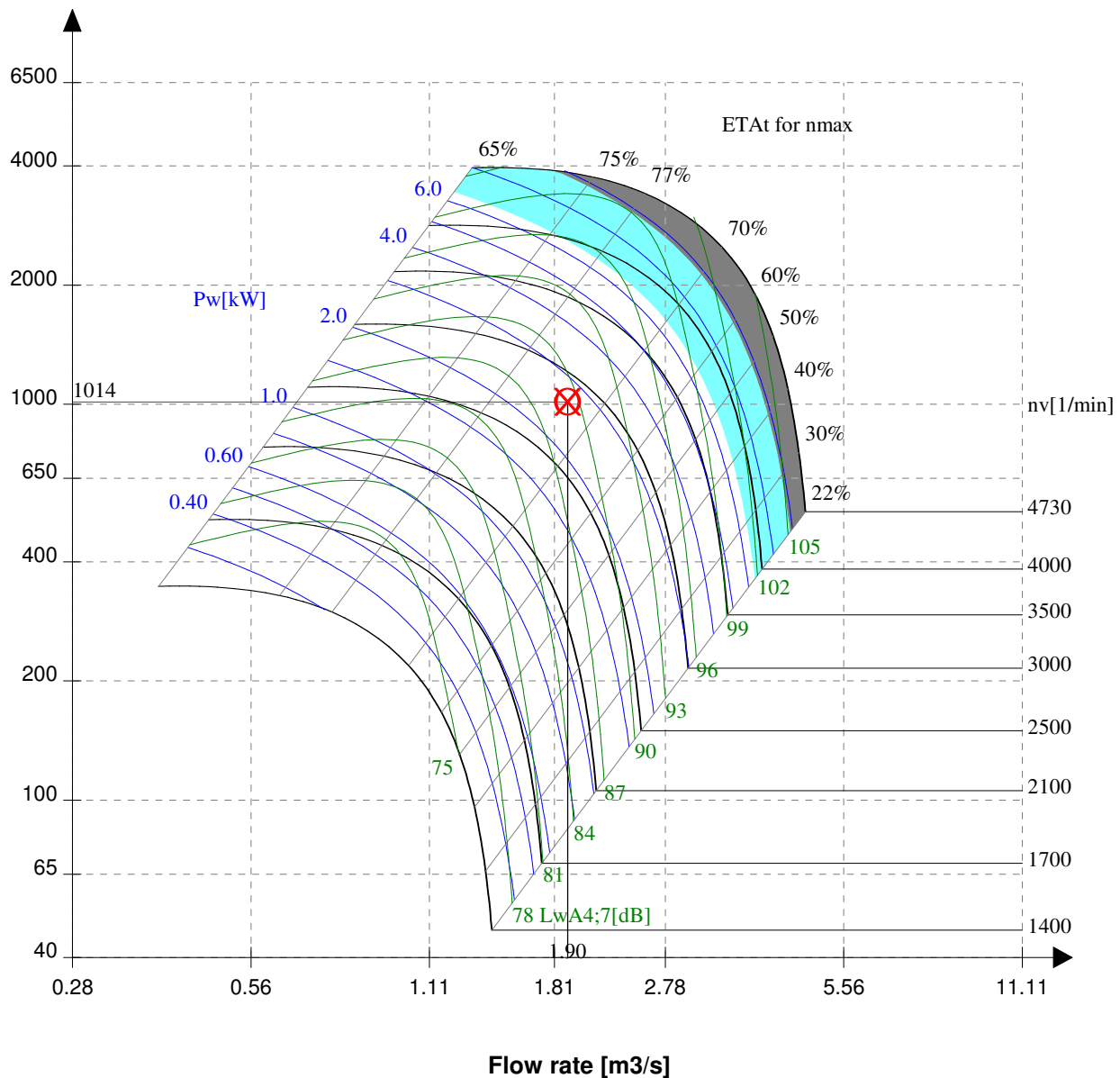

- RZR 19- ... only
- Do not use in this area

Customer : **MJL**
Reference : **British Museum - WCEC**
Item No : **AHU/B2/02 Supply**

Date : **07.06.2012**
Made by : **Jim Picken**
Page : **1**

Technical data

... for fan: RZR 11-0315

Installation acc. to DIN 24 163 part 1	:	B
Flow rate (V)	:	1.70 m ³ /s
Total pressure (dpt)	:	947 Pa
Dyn. pressure (pd2) at discharge	:	67 Pa
Static pressure (dpfa)	:	880 Pa
Pressure losses (pv) at intake	:	0 Pa
Reference density (Rho1)	:	1.20 kg/m ³
Temperature t of the gas (t)	:	20 °C
Speed (n _v)	:	2665 1/min ^{1.)}
Power on shaft (Pw)	:	2.16 kW
Efficiency (ETA _t)	:	75 %
Fan weight	:	24 kg
A-Sound power level LwA _{4,7}	:	87 dB

1.) Fan speed tolerances of ±4% may occur when calculating the belt drive. This may cause technical data being slightly different to the values above.

	63 Hz	:	94/80 dB ^{2.)}
unweighted	125 Hz	:	88/83 dB
Octave sound power level	250 Hz	:	85/82 dB
acc. to discharge/intake	500 Hz	:	84/86 dB
LwOkt _{4,7} at	1000 Hz	:	81/81 dB
Octave band frequency	2000 Hz	:	77/78 dB
	4000 Hz	:	72/73 dB
	8000 Hz	:	64/66 dB

2.) The octave sound power levels can reach unpredictable higher values than calculated in the octave band of the blade passing frequencies.

... for motor: 112M-2

Size	:	112M-2
Speed	:	2905 rpm
Power	:	4 kW
Voltage/Frequency	:	400/690/50 V/Hz
Electric current	:	7.8/4.5 A

Customer : **MJL**
Reference : **British Museum - WCEC**
Item No : **AHU/B2/02 Supply**

Date : **07.06.2012**
Made by : **Jim Picken**
Page : **2**

Fan curves: RZR 11-0315

Basis:

Reference density (Rho1) : 1.20 kg/m³
Install: B

Total pressure [Pa]

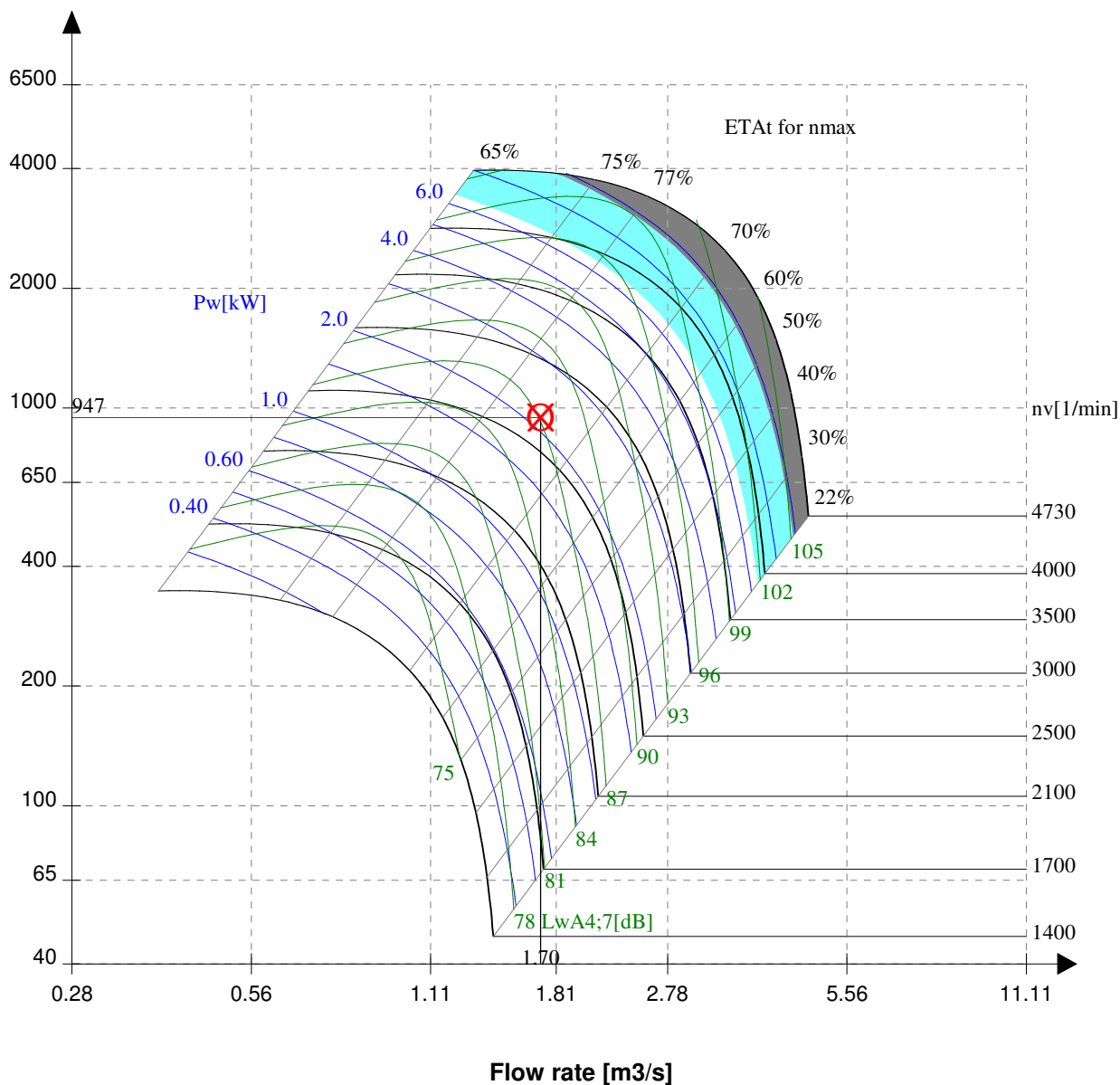

- RZR 19- ... only
- Do not use in this area

Customer : **MJL**
Reference : **British Museum - WCEC**
Item No : **AHU/B2/03 Supply**

Date : **06.06.2012**
Made by : **Jim Picken**
Page : **1**

Technical data

... for fan: RZR 15-0630

Installation acc. to DIN 24 163 part 1	:	B
Flow rate (V)	:	5.50 m ³ /s
Total pressure (dpt)	:	1440 Pa
Dyn. pressure (pd2) at discharge	:	45 Pa
Static pressure (dpfa)	:	1395 Pa
Pressure losses (pv) at intake	:	45 Pa
Reference density (Rho1)	:	1.20 kg/m ³
Temperature t of the gas (t)	:	20 °C
Speed (n _v)	:	1452 1/min ^{1.)}
Power on shaft (Pw)	:	9.84 kW
Efficiency (ETA _t)	:	80 %
Fan weight	:	149 kg
A-Sound power level LwA _{4,7}	:	88 dB

1.) Fan speed tolerances of ±4% may occur when calculating the belt drive. This may cause technical data being slightly different to the values above.

unweighted	63 Hz	:	95/81 dB ^{2.)}
	125 Hz	:	89/84 dB
Octave sound power level	250 Hz	:	86/83 dB
acc. to discharge/intake	500 Hz	:	85/87 dB
LwOkt _{4,7} at	1000 Hz	:	82/82 dB
Octave band frequency	2000 Hz	:	78/79 dB
	4000 Hz	:	73/74 dB
	8000 Hz	:	65/67 dB

2.) The octave sound power levels can reach unpredictable higher values than calculated in the octave band of the blade passing frequencies.

... for motor: 160L-4

Size	:	160L-4
Speed	:	1460 rpm
Power	:	15 kW
Voltage/Frequency	:	400/690/50 V/Hz
Electric current	:	28.5/16.5 A

Customer : **MJL**
Reference : **British Museum - WCEC**
Item No : **AHU/B2/03 Supply**

Date : **06.06.2012**
Made by : **Jim Picken**
Page : **2**

Fan curves: RZR 15-0630

Basis:

Reference density (Rho1) : 1.20 kg/m³
Install: B

Total pressure [Pa]

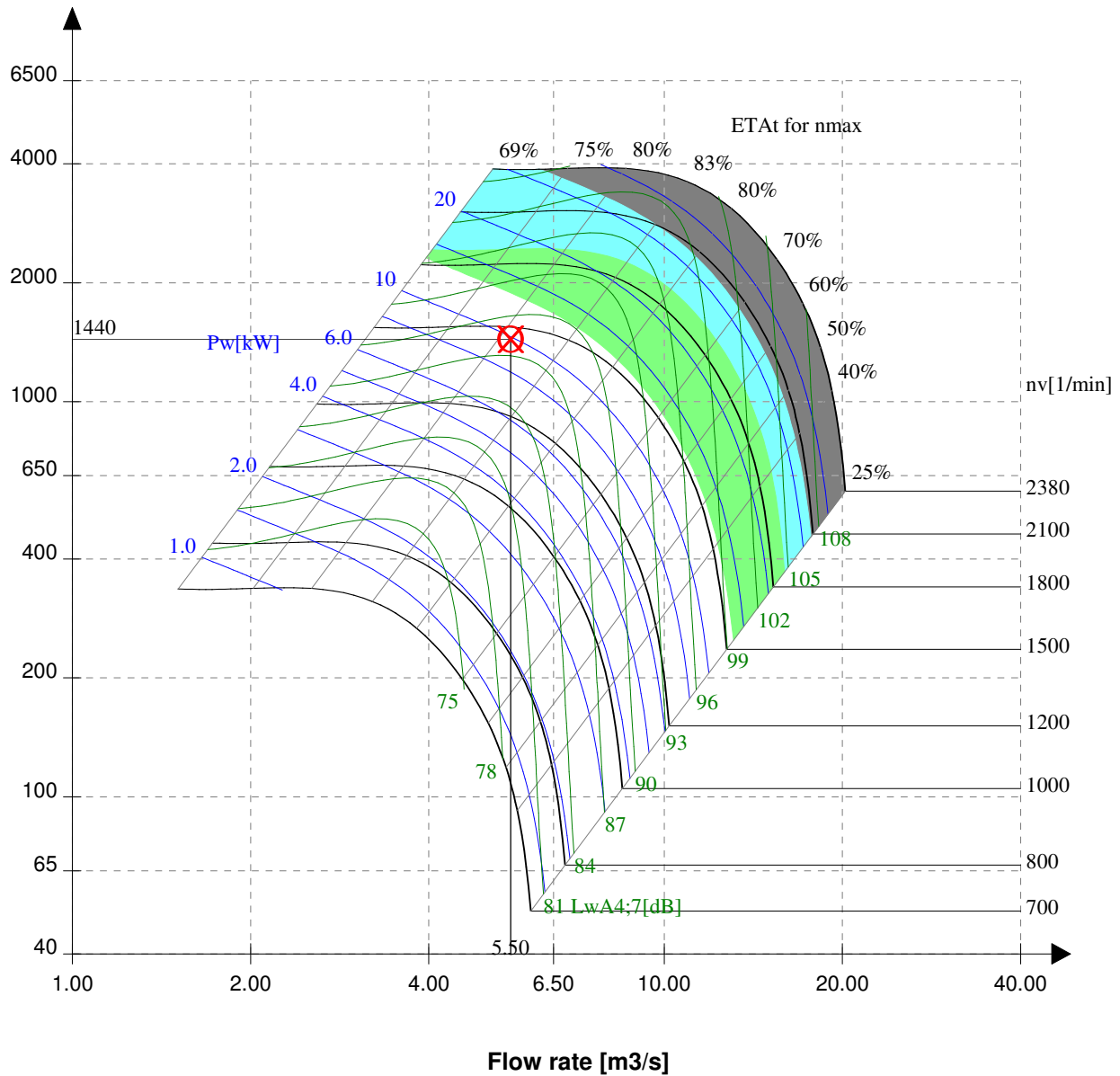

- RZR 13-/15-/18-/19-... only
- RZR 13-/18- ... only
- Do not use in this area

Customer : **MJL**
Reference : **British Museum - WCEC**
Item No : **AHU/B2/03 Extract**

Date : **06.06.2012**
Made by : **Jim Picken**
Page : **1**

Technical data

... for fan: RZR 15-0500

Installation acc. to DIN 24 163 part 1	:	B
Flow rate (V)	:	4.00 m ³ /s
Total pressure (dpt)	:	818 Pa
Dyn. pressure (pd ₂) at discharge	:	59 Pa
Static pressure (dpfa)	:	759 Pa
Pressure losses (pv) at intake	:	59 Pa
Reference density (Rho1)	:	1.20 kg/m ³
Temperature t of the gas (t)	:	20 °C
Speed (n _v)	:	1513 1/min ^{1.)}
Power on shaft (Pw)	:	4.13 kW
Efficiency (ETA _t)	:	79 %
Fan weight	:	94 kg
A-Sound power level LwA _{4,7}	:	84 dB

1.) Fan speed tolerances of ±4% may occur when calculating the belt drive. This may cause technical data being slightly different to the values above.

unweighted	63 Hz	:	91/77 dB ^{2.)}
	125 Hz	:	85/80 dB
Octave sound power level	250 Hz	:	82/79 dB
acc. to discharge/intake	500 Hz	:	81/83 dB
LwOkt _{4,7} at	1000 Hz	:	78/78 dB
Octave band frequency	2000 Hz	:	74/75 dB
	4000 Hz	:	69/70 dB
	8000 Hz	:	61/63 dB

2.) The octave sound power levels can reach unpredictable higher values than calculated in the octave band of the blade passing frequencies.

... for motor: 132M-4

Size	:	132M-4
Speed	:	1455 rpm
Power	:	7,5 kW
Voltage/Frequency	:	400/690/50 V/Hz
Electric current	:	15.2/8.8 A

Customer : **MJL**
Reference : **British Museum - WCEC**
Item No : **AHU/B2/03 Extract**

Date : **06.06.2012**
Made by : **Jim Picken**
Page : **2**

Fan curves: RZR 15-0500

Basis:

Reference density (Rho1) : 1.20 kg/m³
Install: B

Total pressure [Pa]

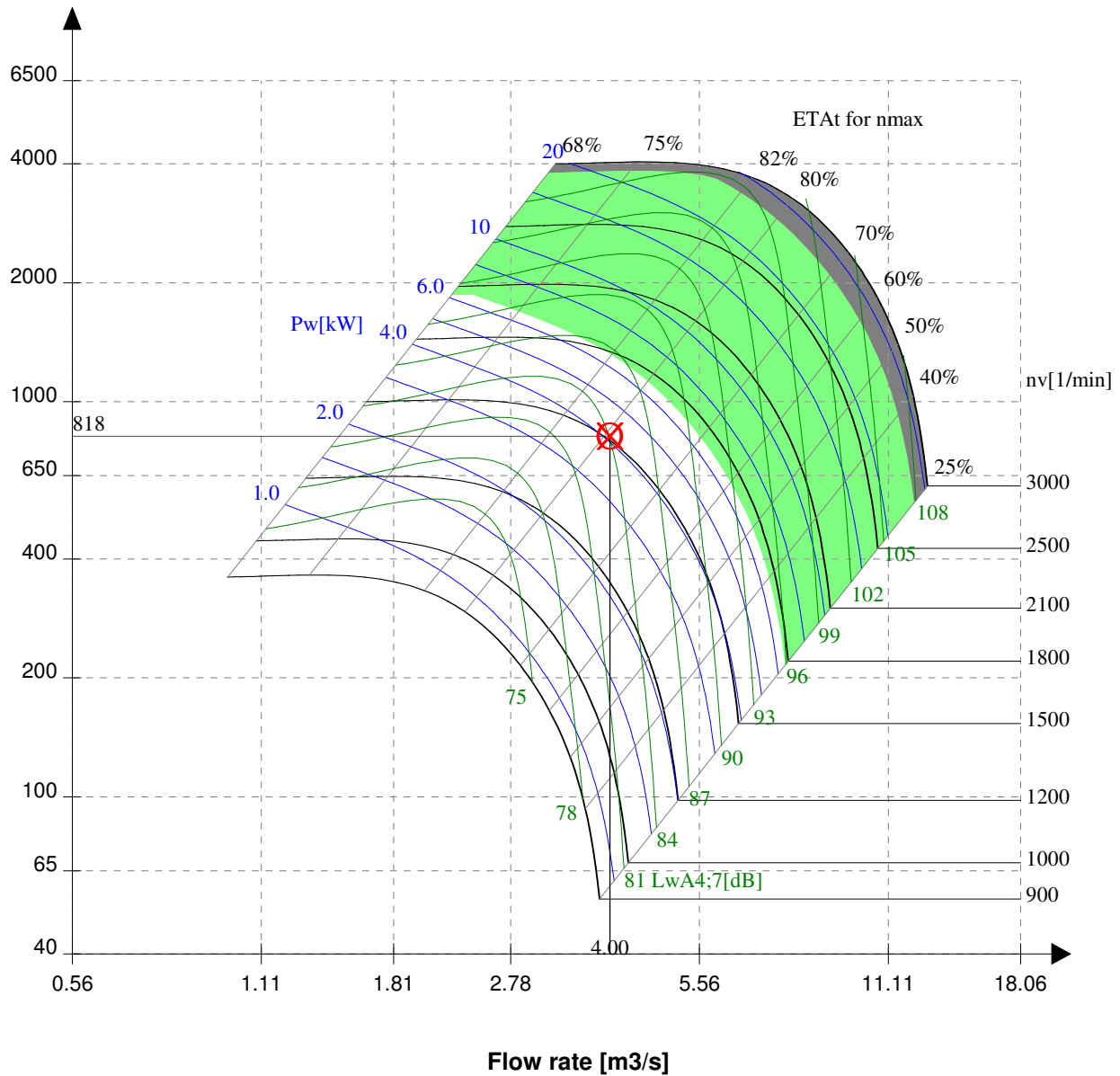

- RZR 13-/15-/18-/19-... only
- Do not use in this area

Customer : **MJL**
Reference : **British Museum - WCEC**
Item No : **AHU/B2/04 Supply**

Date : **06.06.2012**
Made by : **Jim Picken**
Page : **1**

Technical data

... for fan: RZR 15-0500

Installation acc. to DIN 24 163 part 1	:	B
Flow rate (V)	:	3.20 m ³ /s
Total pressure (dpt)	:	1288 Pa
Dyn. pressure (pd2) at discharge	:	38 Pa
Static pressure (dpfa)	:	1250 Pa
Pressure losses (pv) at intake	:	0 Pa
Reference density (Rho1)	:	1.20 kg/m ³
Temperature t of the gas (t)	:	20 °C
Speed (n _v)	:	1709 1/min ^{1.)}
Power on shaft (Pw)	:	5.17 kW
Efficiency (ETA _t)	:	80 %
Fan weight	:	94 kg
A-Sound power level LwA _{4,7}	:	85 dB

1.) Fan speed tolerances of ±4% may occur when calculating the belt drive. This may cause technical data being slightly different to the values above.

	63 Hz	:	92/78 dB ^{2.)}
unweighted	125 Hz	:	86/81 dB
Octave sound power level	250 Hz	:	83/80 dB
acc. to discharge/intake	500 Hz	:	82/84 dB
LwOkt _{4,7} at	1000 Hz	:	79/79 dB
Octave band frequency	2000 Hz	:	75/76 dB
	4000 Hz	:	70/71 dB
	8000 Hz	:	62/64 dB

2.) The octave sound power levels can reach unpredictable higher values than calculated in the octave band of the blade passing frequencies.

... for motor: 132M-4

Size	:	132M-4
Speed	:	1455 rpm
Power	:	7,5 kW
Voltage/Frequency	:	400/690/50 V/Hz
Electric current	:	15.2/8.8 A

Customer : **MJL**
Reference : **British Museum - WCEC**
Item No : **AHU/B2/04 Supply**

Date : **06.06.2012**
Made by : **Jim Picken**
Page : **2**

Fan curves: RZR 15-0500

Basis:

Reference density (Rho1) : 1.20 kg/m³
Install: B

Total pressure [Pa]

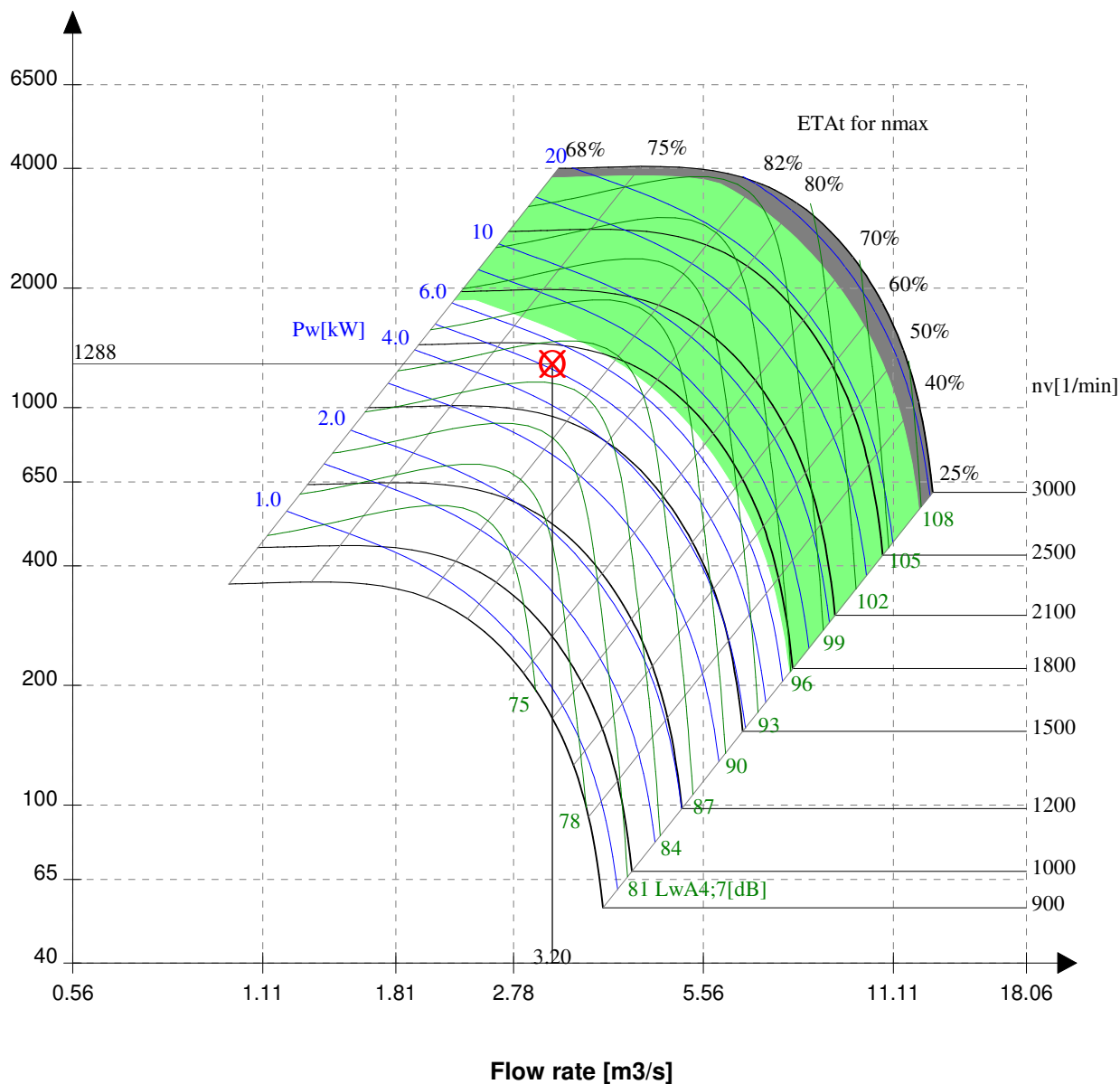

RZR 13-/15-/18-/19-... only
 Do not use in this area

Customer : **MJL**
Reference : **British Museum - WCEC**
Item No : **AHU/B2/04 Extract**

Date : **06.06.2012**
Made by : **Jim Picken**
Page : **1**

Technical data

... for fan: RZR 15-0450

Installation acc. to DIN 24 163 part 1	:	B
Flow rate (V)	:	3.20 m ³ /s
Total pressure (dpt)	:	940 Pa
Dyn. pressure (pd2) at discharge	:	60 Pa
Static pressure (dpfa)	:	880 Pa
Pressure losses (pv) at intake	:	60 Pa
Reference density (Rho1)	:	1.20 kg/m ³
Temperature t of the gas (t)	:	20 °C
Speed (n _v)	:	1800 1/min ^{1.)}
Power on shaft (Pw)	:	3.78 kW
Efficiency (ETA _t)	:	80 %
Fan weight	:	73 kg
A-Sound power level LwA _{4,7}	:	85 dB

1.) Fan speed tolerances of ±4% may occur when calculating the belt drive. This may cause technical data being slightly different to the values above.

unweighted	63 Hz	:	92/78 dB ^{2.)}
	125 Hz	:	86/81 dB
Octave sound power level	250 Hz	:	83/80 dB
acc. to discharge/intake	500 Hz	:	82/84 dB
LwOkt _{4,7} at	1000 Hz	:	79/79 dB
Octave band frequency	2000 Hz	:	75/76 dB
	4000 Hz	:	70/71 dB
	8000 Hz	:	62/64 dB

2.) The octave sound power levels can reach unpredictable higher values than calculated in the octave band of the blade passing frequencies.

... for motor: 132S-4

Size	:	132S-4
Speed	:	1455 rpm
Power	:	5,5 kW
Voltage/Frequency	:	400/690/50 V/Hz
Electric current	:	11.4/6.6 A

Customer : **MJL**
Reference : **British Museum - WCEC**
Item No : **AHU/B2/04 Extract**

Date : **06.06.2012**
Made by : **Jim Picken**
Page : **2**

Fan curves: RZR 15-0450

Basis:

Reference density (Rho1) : 1.20 kg/m³
Install: B

Total pressure [Pa]

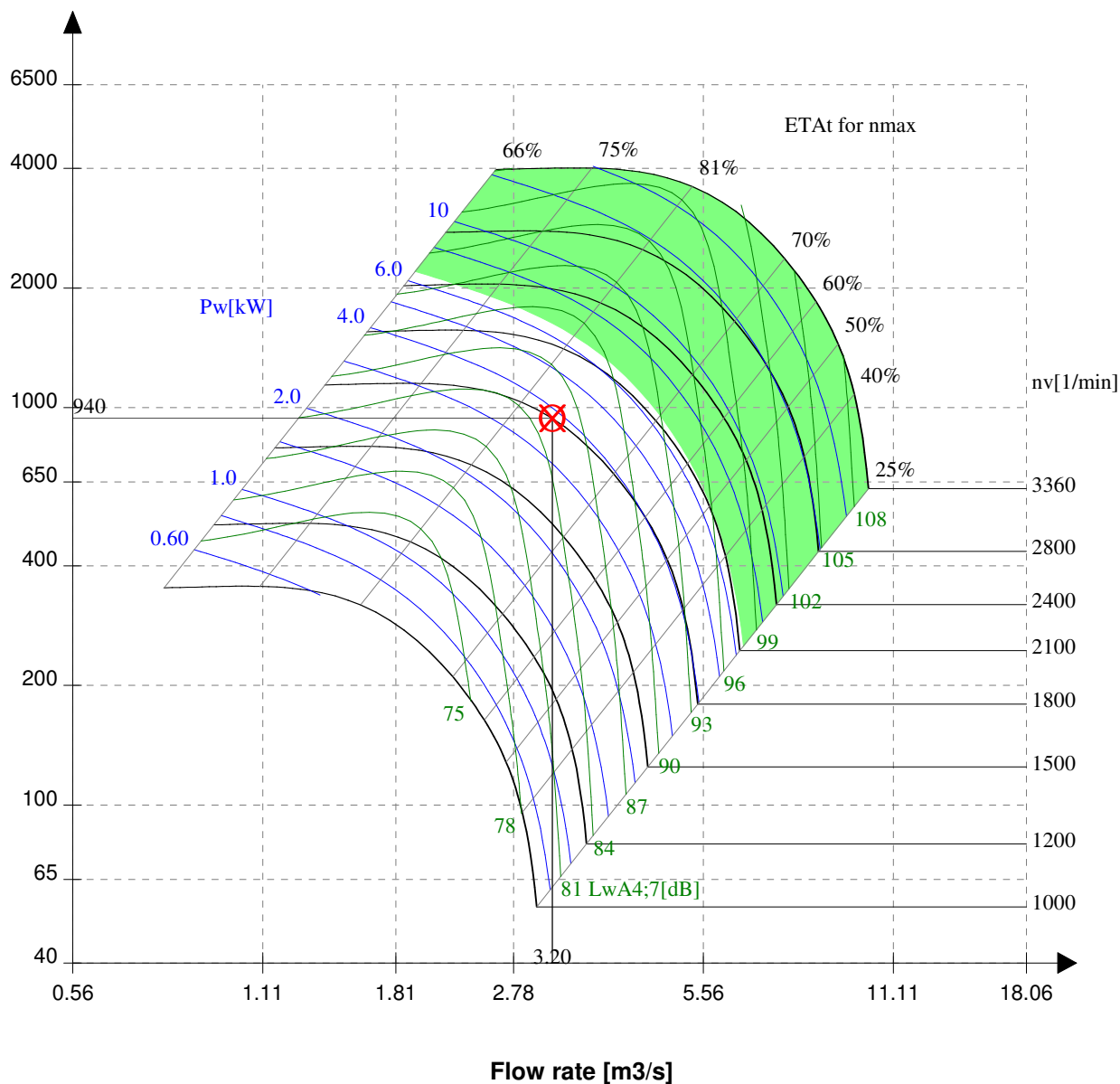

■ RZR 13-/15-/18-/19-... only

Customer : **MJL**
Reference : **British Museum - WCEC**
Item No : **AHU/00/01 Supply**

Date : **06.06.2012**
Made by : **Jim Picken**
Page : **1**

Technical data

... for fan: RZR 11-0315

Installation acc. to DIN 24 163 part 1	:	B
Flow rate (V)	:	1.50 m ³ /s
Total pressure (dpt)	:	1374 Pa
Dyn. pressure (pd2) at discharge	:	52 Pa
Static pressure (dpfa)	:	1322 Pa
Pressure losses (pv) at intake	:	52 Pa
Reference density (Rho1)	:	1.20 kg/m ³
Temperature t of the gas (t)	:	20 °C
Speed (n _v)	:	2948 1/min ^{1.)}
Power on shaft (Pw)	:	2.71 kW
Efficiency (ETA _t)	:	76 %
Fan weight	:	24 kg
A-Sound power level LwA _{4,7}	:	88 dB

1.) Fan speed tolerances of ±4% may occur when calculating the belt drive. This may cause technical data being slightly different to the values above.

unweighted	63 Hz	:	95/81 dB ^{2.)}
	125 Hz	:	89/84 dB
Octave sound power level	250 Hz	:	86/83 dB
acc. to discharge/intake	500 Hz	:	85/87 dB
LwOkt _{4,7} at	1000 Hz	:	82/82 dB
Octave band frequency	2000 Hz	:	78/79 dB
	4000 Hz	:	73/74 dB
	8000 Hz	:	65/67 dB

2.) The octave sound power levels can reach unpredictable higher values than calculated in the octave band of the blade passing frequencies.

... for motor: 112M-2

Size	:	112M-2
Speed	:	2905 rpm
Power	:	4 kW
Voltage/Frequency	:	400/690/50 V/Hz
Electric current	:	7.8/4.5 A

Customer : **MJL**
Reference : **British Museum - WCEC**
Item No : **AHU/00/01 Supply**

Date : **06.06.2012**
Made by : **Jim Picken**
Page : **2**

Fan curves: RZR 11-0315

Basis:

Reference density (Rho1) : 1.20 kg/m³
Install: B

Total pressure [Pa]

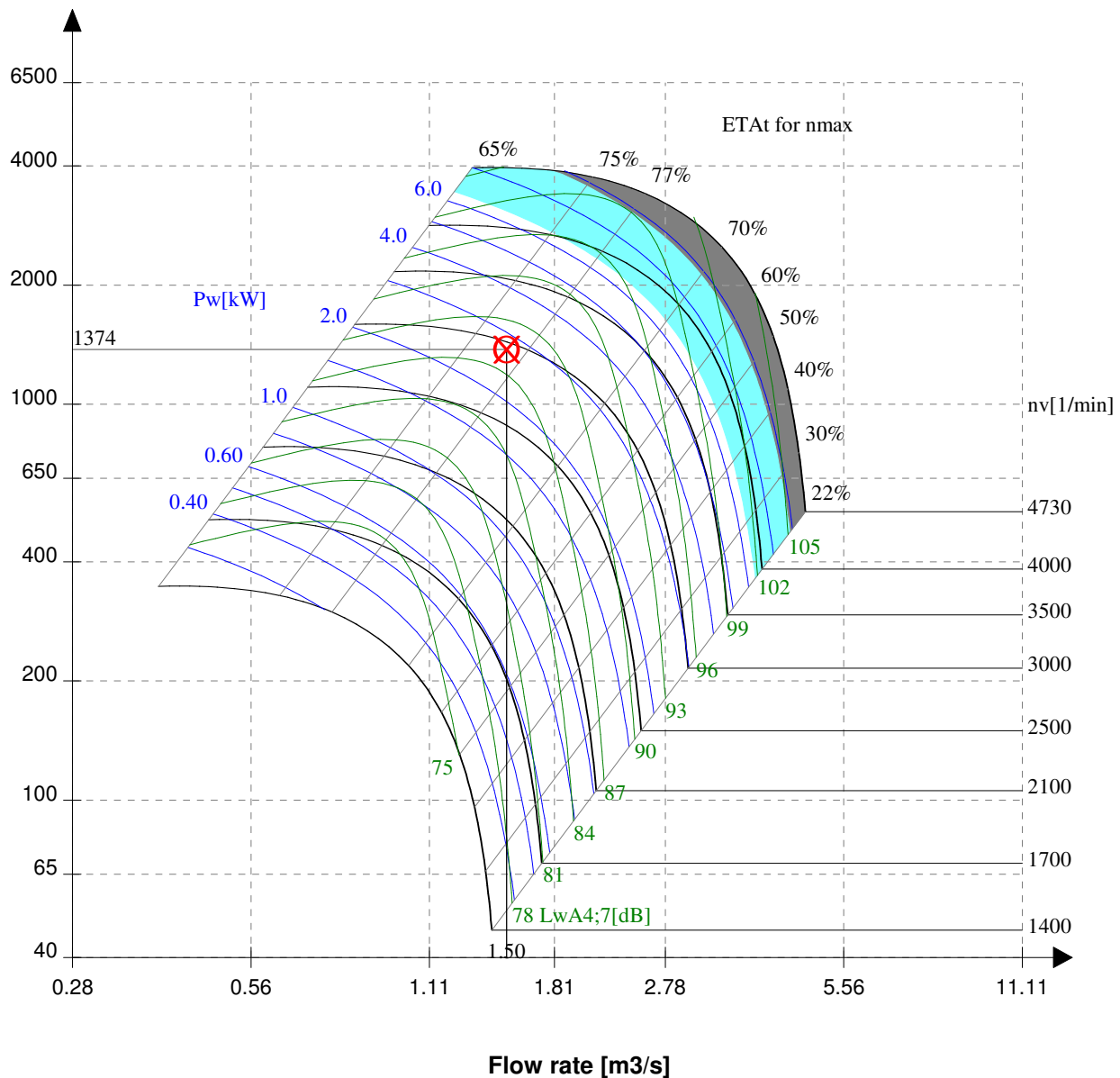

- RZR 19- ... only
- Do not use in this area

Customer : **MJL**
Reference : **British Museum - WCEC**
Item No : **AHU/00/01 Extract**

Date : **06.06.2012**
Made by : **Jim Picken**
Page : **1**

Technical data

... for fan: RZR 11-0315

Installation acc. to DIN 24 163 part 1	:	B
Flow rate (V)	:	1.50 m ³ /s
Total pressure (dpt)	:	854 Pa
Dyn. pressure (pd2) at discharge	:	52 Pa
Static pressure (dpfa)	:	802 Pa
Pressure losses (pv) at intake	:	52 Pa
Reference density (Rho1)	:	1.20 kg/m ³
Temperature t of the gas (t)	:	20 °C
Speed (n _v)	:	2471 1/min ^{1.)}
Power on shaft (Pw)	:	1.70 kW
Efficiency (ETA _t)	:	75 %
Fan weight	:	24 kg
A-Sound power level LwA _{4,7}	:	85 dB

1.) Fan speed tolerances of ±4% may occur when calculating the belt drive. This may cause technical data being slightly different to the values above.

unweighted	63 Hz	:	92/78 dB ^{2.)}
	125 Hz	:	86/81 dB
Octave sound power level	250 Hz	:	83/80 dB
acc. to discharge/intake	500 Hz	:	82/84 dB
LwOkt _{4,7} at	1000 Hz	:	79/79 dB
Octave band frequency	2000 Hz	:	75/76 dB
	4000 Hz	:	70/71 dB
	8000 Hz	:	62/64 dB

2.) The octave sound power levels can reach unpredictable higher values than calculated in the octave band of the blade passing frequencies.

... for motor: 100L-2

Size	:	100L-2
Speed	:	2890 rpm
Power	:	3 kW
Voltage/Frequency	:	400/690/50 V/Hz
Electric current	:	6.1/3.5 A

Customer : **MJL**
Reference : **British Museum - WCEC**
Item No : **AHU/00/01 Extract**

Date : **06.06.2012**
Made by : **Jim Picken**
Page : **2**

Fan curves: RZR 11-0315

Basis:

Reference density (Rho1) : 1.20 kg/m³
Install: B

Total pressure [Pa]

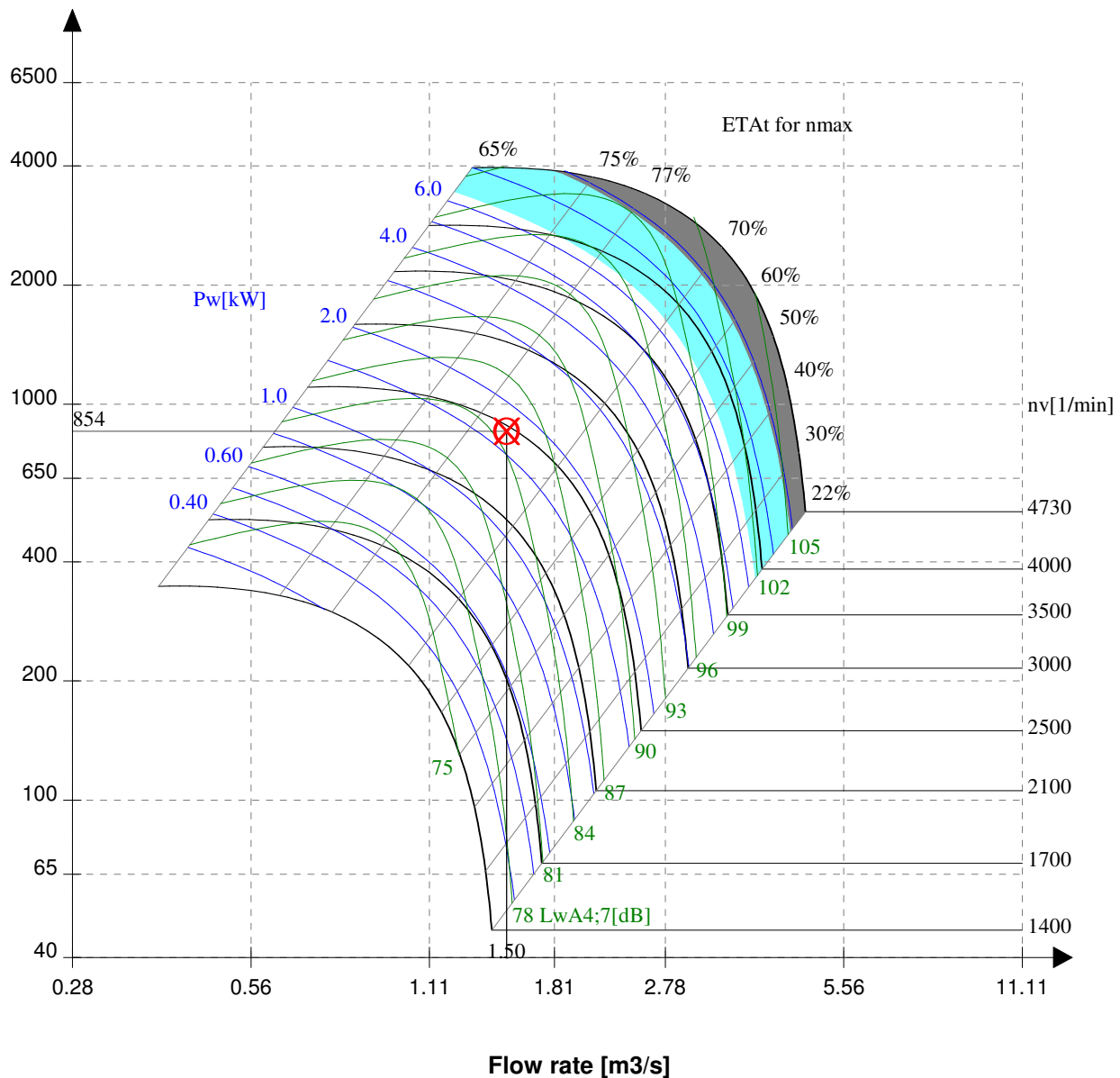

- RZR 19- ... only
- Do not use in this area

Customer : **MJL**
Reference : **British Museum - WCEC**
Item No : **AHU/01/01 Supply**

Date : **06.06.2012**
Made by : **Jim Picken**
Page : **1**

Technical data

... for fan: RZR 11-0225

Installation acc. to DIN 24 163 part 1	:	B
Flow rate (V)	:	0.50 m ³ /s
Total pressure (dpt)	:	692 Pa
Dyn. pressure (pd2) at discharge	:	22 Pa
Static pressure (dpfa)	:	670 Pa
Pressure losses (pv) at intake	:	0 Pa
Reference density (Rho1)	:	1.20 kg/m ³
Temperature t of the gas (t)	:	20 °C
Speed (n _v)	:	2879 1/min ^{1.)}
Power on shaft (Pw)	:	0.49 kW
Efficiency (ETA _t)	:	70 %
Fan weight	:	13 kg
A-Sound power level LwA _{4,7}	:	77 dB

1.) Fan speed tolerances of ±4% may occur when calculating the belt drive. This may cause technical data being slightly different to the values above.

unweighted	63 Hz	:	84/70 dB ^{2.)}
	125 Hz	:	82/77 dB
Octave sound power level	250 Hz	:	78/75 dB
acc. to discharge/intake	500 Hz	:	76/75 dB
LwOkt _{4,7} at	1000 Hz	:	70/72 dB
Octave band frequency	2000 Hz	:	66/68 dB
	4000 Hz	:	59/63 dB
	8000 Hz	:	48/55 dB

2.) The octave sound power levels can reach unpredictable higher values than calculated in the octave band of the blade passing frequencies.

... for motor: 80b-2

Size	:	80b-2
Speed	:	2845 rpm
Power	:	1,1 kW
Voltage/Frequency	:	230/400/50 V/Hz
Electric current	:	4.2/2.4 A

Customer : **MJL**
Reference : **British Museum - WCEC**
Item No : **AHU/01/01 Supply**

Date : **06.06.2012**
Made by : **Jim Picken**
Page : **2**

Fan curves: RZR 11-0225

Basis:

Reference density (Rho1) : 1.20 kg/m³
Install: B

Total pressure [Pa]

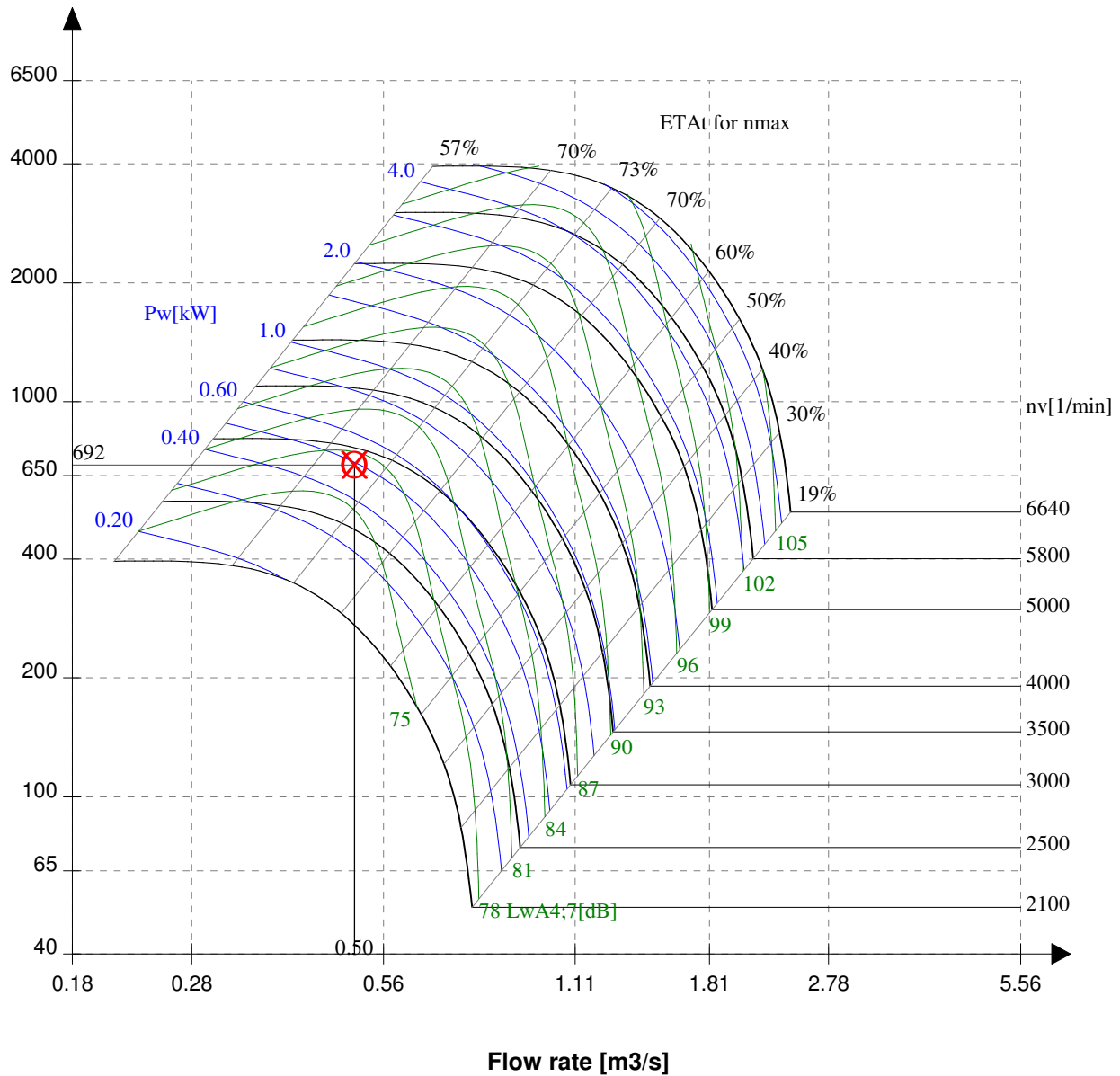

Customer : **MJL**
Reference : **British Museum - WCEC**
Item No : **AHU/01/01 Extract**

Date : **06.06.2012**
Made by : **Jim Picken**
Page : **1**

Technical data

... for fan: RZR 11-0225

Installation acc. to DIN 24 163 part 1	:	B
Flow rate (V)	:	0.50 m ³ /s
Total pressure (dpt)	:	735 Pa
Dyn. pressure (pd2) at discharge	:	22 Pa
Static pressure (dpfa)	:	712 Pa
Pressure losses (pv) at intake	:	22 Pa
Reference density (Rho1)	:	1.20 kg/m ³
Temperature t of the gas (t)	:	20 °C
Speed (n _v)	:	2950 1/min ^{1.)}
Power on shaft (Pw)	:	0.52 kW
Efficiency (ETA _t)	:	70 %
Fan weight	:	13 kg
A-Sound power level LwA _{4,7}	:	78 dB

1.) Fan speed tolerances of ±4% may occur when calculating the belt drive. This may cause technical data being slightly different to the values above.

unweighted	63 Hz	:	85/71 dB ^{2.)}
	125 Hz	:	83/78 dB
Octave sound power level	250 Hz	:	79/76 dB
acc. to discharge/intake	500 Hz	:	77/76 dB
LwOkt _{4,7} at	1000 Hz	:	71/73 dB
Octave band frequency	2000 Hz	:	67/69 dB
	4000 Hz	:	60/64 dB
	8000 Hz	:	49/56 dB

2.) The octave sound power levels can reach unpredictable higher values than calculated in the octave band of the blade passing frequencies.

... for motor: 80b-2

Size	:	80b-2
Speed	:	2845 rpm
Power	:	1,1 kW
Voltage/Frequency	:	230/400/50 V/Hz
Electric current	:	4.2/2.4 A

Customer : **MJL**
Reference : **British Museum - WCEC**
Item No : **AHU/01/01 Extract**

Date : **06.06.2012**
Made by : **Jim Picken**
Page : **2**

Fan curves: RZR 11-0225

Basis:

Reference density (Rho1) : 1.20 kg/m³
Install: B

Total pressure [Pa]

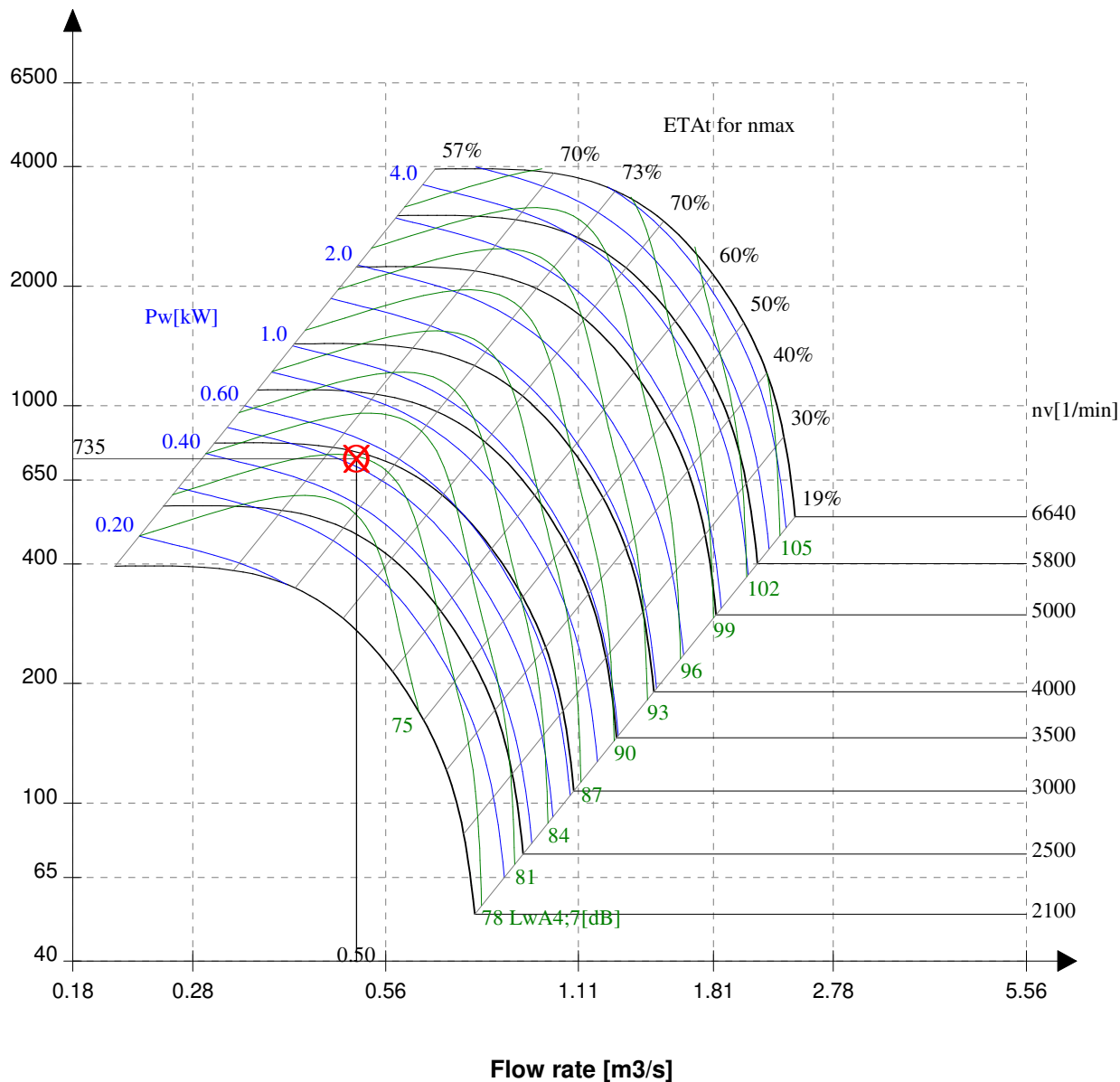

Customer : **MJL**
Reference : **British Museum - WCEC**
Item No : **AHU/01/02 Supply**

Date : **06.06.2012**
Made by : **Jim Picken**
Page : **1**

Technical data

... for fan: RZR 11-0225

Installation acc. to DIN 24 163 part 1	:	B
Flow rate (V)	:	0.60 m ³ /s
Total pressure (dpt)	:	732 Pa
Dyn. pressure (pd2) at discharge	:	32 Pa
Static pressure (dpfa)	:	700 Pa
Pressure losses (pv) at intake	:	0 Pa
Reference density (Rho1)	:	1.20 kg/m ³
Temperature t of the gas (t)	:	20 °C
Speed (n _v)	:	3073 1/min ^{1.)}
Power on shaft (Pw)	:	0.62 kW
Efficiency (ETA _t)	:	71 %
Fan weight	:	13 kg
A-Sound power level LwA _{4,7}	:	79 dB

1.) Fan speed tolerances of ±4% may occur when calculating the belt drive. This may cause technical data being slightly different to the values above.

unweighted	63 Hz	:	86/72 dB ^{2.)}
	125 Hz	:	84/79 dB
Octave sound power level	250 Hz	:	80/77 dB
acc. to discharge/intake	500 Hz	:	78/77 dB
LwOkt _{4,7} at	1000 Hz	:	72/74 dB
Octave band frequency	2000 Hz	:	68/70 dB
	4000 Hz	:	61/65 dB
	8000 Hz	:	50/57 dB

2.) The octave sound power levels can reach unpredictable higher values than calculated in the octave band of the blade passing frequencies.

... for motor: 80b-2

Size	:	80b-2
Speed	:	2845 rpm
Power	:	1,1 kW
Voltage/Frequency	:	230/400/50 V/Hz
Electric current	:	4.2/2.4 A

Customer : **MJL**
Reference : **British Museum - WCEC**
Item No : **AHU/01/02 Supply**

Date : **06.06.2012**
Made by : **Jim Picken**
Page : **2**

Fan curves: RZR 11-0225

Basis:

Reference density (Rho1) : 1.20 kg/m³
Install: B

Total pressure [Pa]

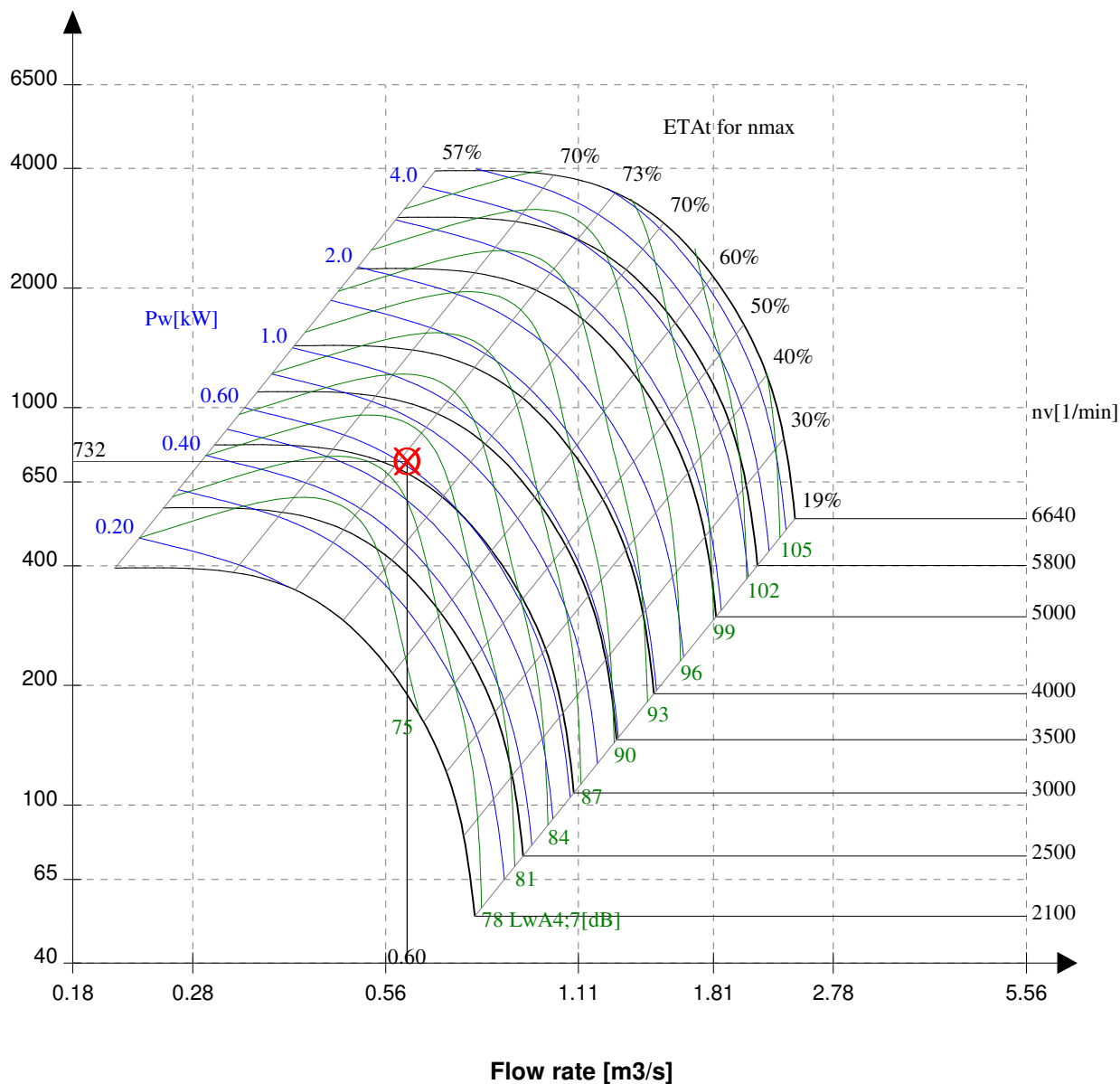

Customer : **MJL**
Reference : **British Museum - WCEC**
Item No : **AHU/01/02 Extract**

Date : **06.06.2012**
Made by : **Jim Picken**
Page : **1**

Technical data

... for fan: RZR 11-0225

Installation acc. to DIN 24 163 part 1	:	B
Flow rate (V)	:	0.60 m ³ /s
Total pressure (dpt)	:	765 Pa
Dyn. pressure (pd2) at discharge	:	32 Pa
Static pressure (dpfa)	:	732 Pa
Pressure losses (pv) at intake	:	32 Pa
Reference density (Rho1)	:	1.20 kg/m ³
Temperature t of the gas (t)	:	20 °C
Speed (n _v)	:	3121 1/min ^{1.)}
Power on shaft (Pw)	:	0.64 kW
Efficiency (ETA _t)	:	71 %
Fan weight	:	13 kg
A-Sound power level LwA _{4,7}	:	80 dB

1.) Fan speed tolerances of ±4% may occur when calculating the belt drive. This may cause technical data being slightly different to the values above.

unweighted	63 Hz	:	87/73 dB ^{2.)}
	125 Hz	:	85/80 dB
Octave sound power level	250 Hz	:	81/78 dB
acc. to discharge/intake	500 Hz	:	79/78 dB
LwOkt _{4,7} at	1000 Hz	:	73/75 dB
Octave band frequency	2000 Hz	:	69/71 dB
	4000 Hz	:	62/66 dB
	8000 Hz	:	51/58 dB

2.) The octave sound power levels can reach unpredictable higher values than calculated in the octave band of the blade passing frequencies.

... for motor: 80b-2

Size	:	80b-2
Speed	:	2845 rpm
Power	:	1,1 kW
Voltage/Frequency	:	230/400/50 V/Hz
Electric current	:	4.2/2.4 A

Customer : **MJL**
Reference : **British Museum - WCEC**
Item No : **AHU/01/02 Extract**

Date : **06.06.2012**
Made by : **Jim Picken**
Page : **2**

Fan curves: RZR 11-0225

Basis:

Reference density (Rho1) : 1.20 kg/m³
Install: B

Total pressure [Pa]

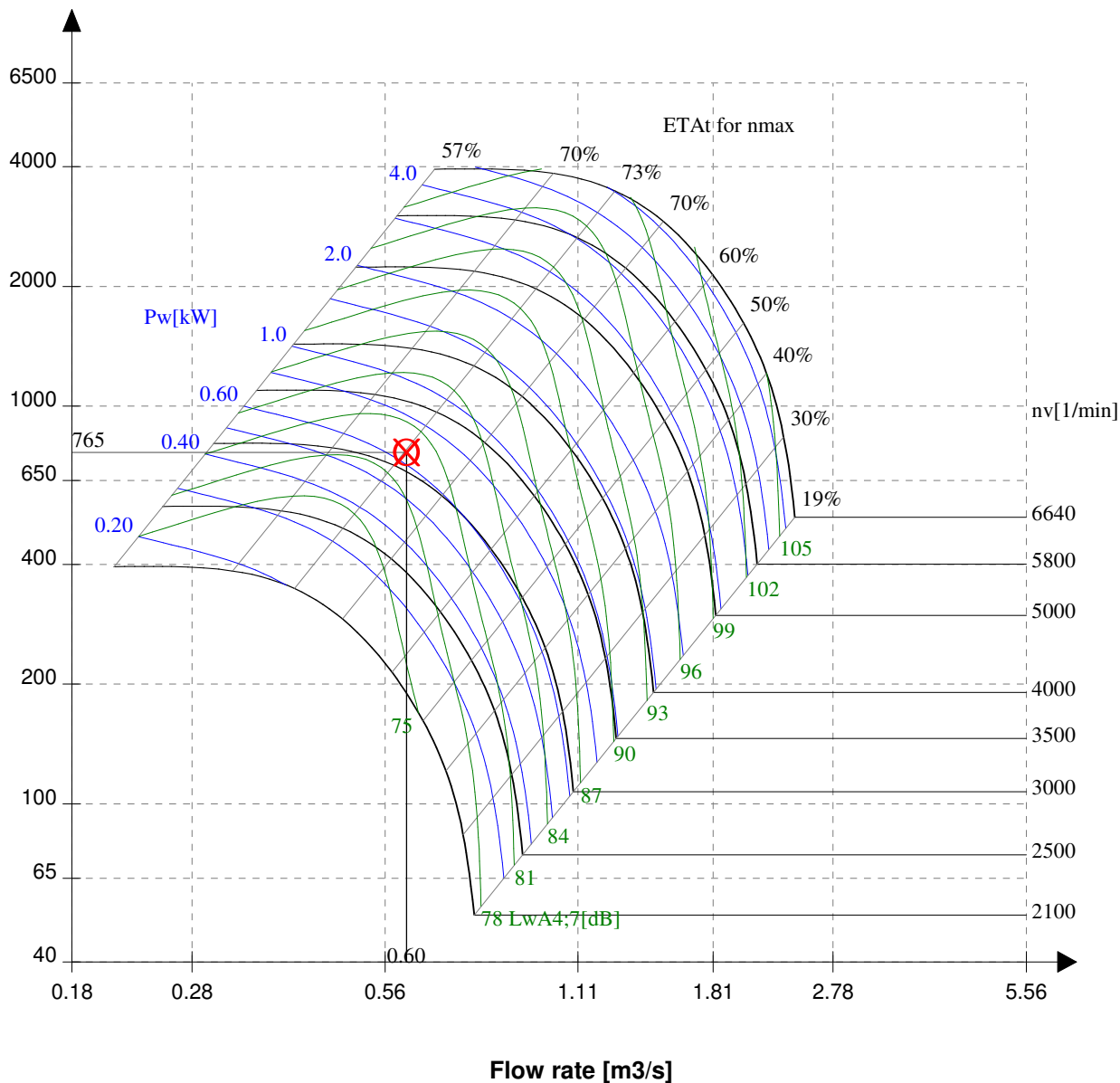

Customer : **MJL**
Reference : **British Museum - WCEC**
Item No : **AHU/02/01 Supply**

Date : **07.06.2012**
Made by : **Jim Picken**
Page : **1**

Technical data

... for fan: RZR 11-0315

Installation acc. to DIN 24 163 part 1	:	B
Flow rate (V)	:	1.80 m ³ /s
Total pressure (dpt)	:	975 Pa
Dyn. pressure (pd2) at discharge	:	75 Pa
Static pressure (dpfa)	:	900 Pa
Pressure losses (pv) at intake	:	0 Pa
Reference density (Rho1)	:	1.20 kg/m ³
Temperature t of the gas (t)	:	20 °C
Speed (n _v)	:	2745 1/min ^{1.)}
Power on shaft (Pw)	:	2.37 kW
Efficiency (ETA _t)	:	74 %
Fan weight	:	24 kg
A-Sound power level LwA _{4,7}	:	88 dB

1.) Fan speed tolerances of ±4% may occur when calculating the belt drive. This may cause technical data being slightly different to the values above.

	63 Hz	:	91/78 dB ^{2.)}
unweighted	125 Hz	:	86/81 dB
Octave sound power level	250 Hz	:	84/80 dB
acc. to discharge/intake	500 Hz	:	85/87 dB
LwOkt _{4,7} at	1000 Hz	:	83/83 dB
Octave band frequency	2000 Hz	:	79/80 dB
	4000 Hz	:	74/75 dB
	8000 Hz	:	65/67 dB

2.) The octave sound power levels can reach unpredictable higher values than calculated in the octave band of the blade passing frequencies.

... for motor: 112M-2

Size	:	112M-2
Speed	:	2905 rpm
Power	:	4 kW
Voltage/Frequency	:	400/690/50 V/Hz
Electric current	:	7.8/4.5 A

Customer : **MJL**
Reference : **British Museum - WCEC**
Item No : **AHU/02/01 Supply**

Date : **07.06.2012**
Made by : **Jim Picken**
Page : **2**

Fan curves: RZR 11-0315

Basis:

Reference density (Rho1) : 1.20 kg/m³
Install: B

Total pressure [Pa]

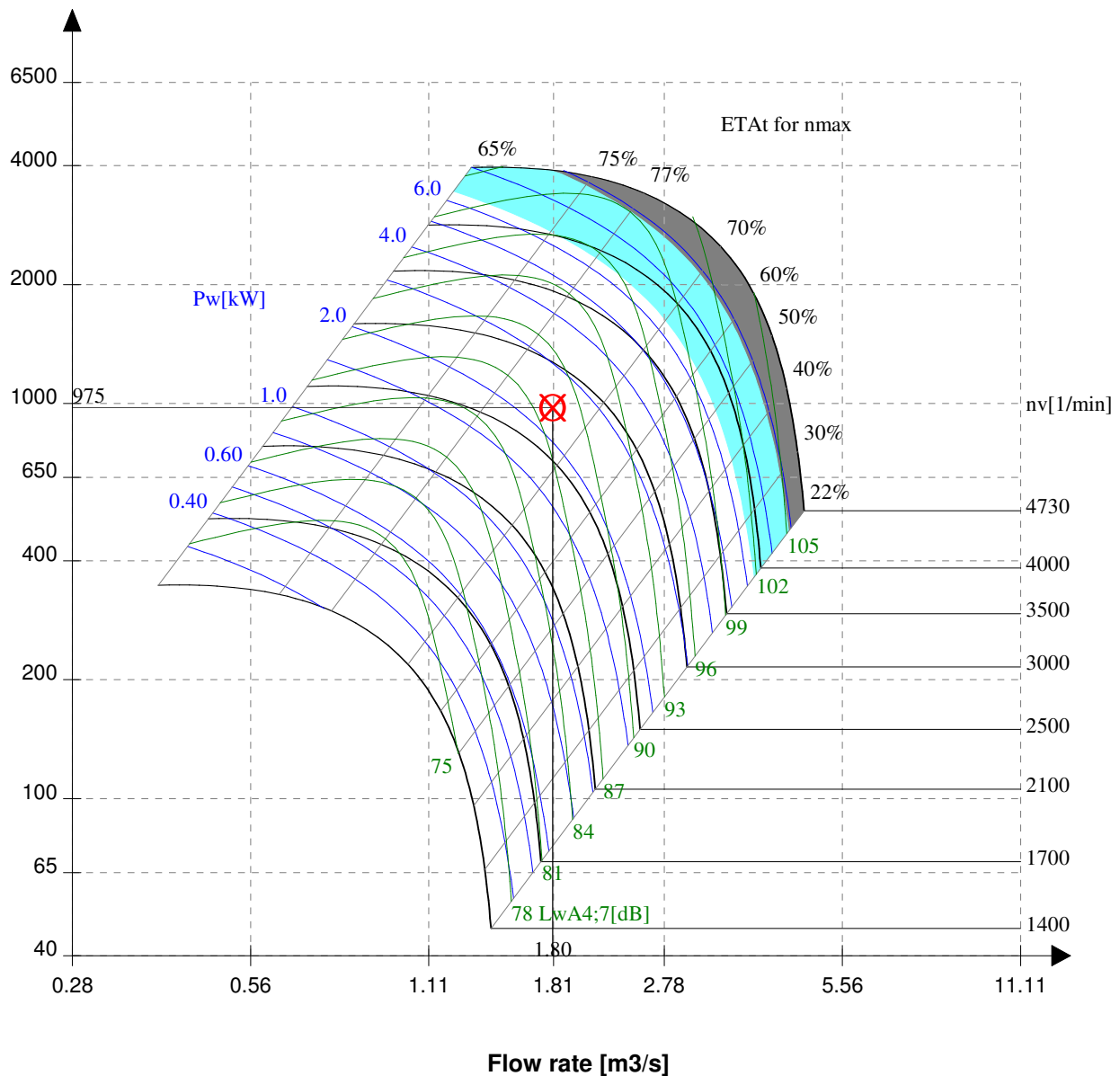

■ RZR 19- ... only
■ Do not use in this area

Customer : **MJL**
Reference : **British Museum - WCEC**
Item No : **AHU/05/01 Supply**

Date : **06.06.2012**
Made by : **Jim Picken**
Page : **1**

Technical data

... for fan: RZR 15-0500

Installation acc. to DIN 24 163 part 1	:	B	
Flow rate (V)	:	5.20	m ³ /s
Total pressure (dpt)	:	1310	Pa
Dyn. pressure (pd2) at discharge	:	100	Pa
Static pressure (dpfa)	:	1210	Pa
Pressure losses (pv) at intake	:	0	Pa
Reference density (Rho1)	:	1.20	kg/m ³
Temperature t of the gas (t)	:	20	°C
Speed (n _v)	:	1933	1/min ^{1.)}
Power on shaft (Pw)	:	8.62	kW
Efficiency (ETA _t)	:	79	%
Fan weight	:	94	kg
A-Sound power level LwA _{4,7}	:	90	dB

1.) Fan speed tolerances of ±4% may occur when calculating the belt drive. This may cause technical data being slightly different to the values above.

unweighted	63 Hz	:	97/83	dB ^{2.)}
	125 Hz	:	91/86	dB
Octave sound power level	250 Hz	:	88/85	dB
acc. to discharge/intake	500 Hz	:	87/89	dB
LwOkt _{4,7} at	1000 Hz	:	84/84	dB
Octave band frequency	2000 Hz	:	80/81	dB
	4000 Hz	:	75/76	dB
	8000 Hz	:	67/69	dB

2.) The octave sound power levels can reach unpredictable higher values than calculated in the octave band of the blade passing frequencies.

... for motor: 160L-4

Size	:	160L-4
Speed	:	1460 rpm
Power	:	15 kW
Voltage/Frequency	:	400/690/50 V/Hz
Electric current	:	28.5/16.5 A

Customer : **MJL**
Reference : **British Museum - WCEC**
Item No : **AHU/05/01 Supply**

Date : **06.06.2012**
Made by : **Jim Picken**
Page : **2**

Fan curves: RZR 15-0500

Basis:

Reference density (Rho1) : 1.20 kg/m³
Install: B

Total pressure [Pa]

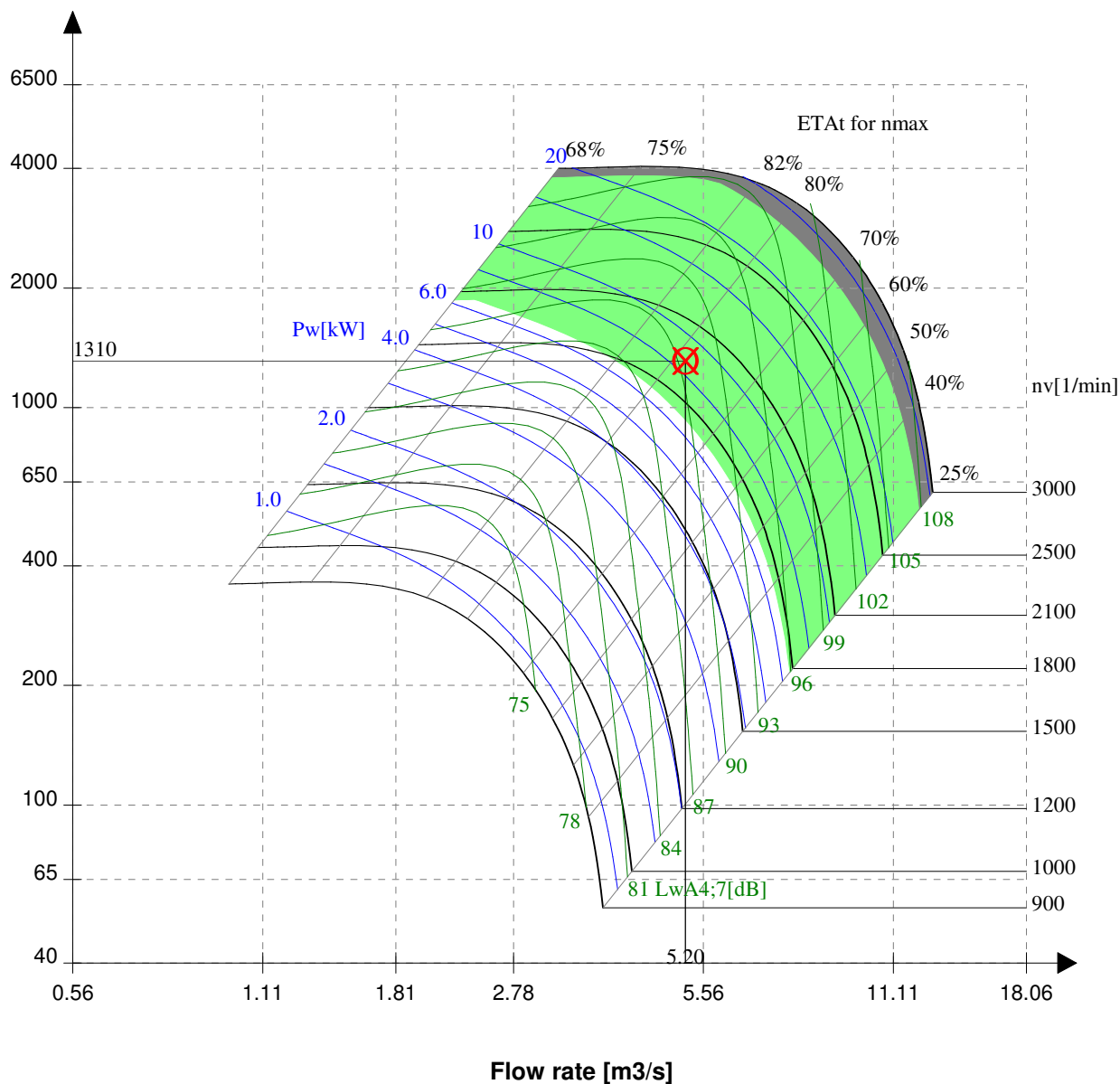

RZR 13-/15-/18-/19-... only
 Do not use in this area

Customer : **MJL**
Reference : **British Museum - WCEC**
Item No : **AHU/05/01 Extract**

Date : **06.06.2012**
Made by : **Jim Picken**
Page : **1**

Technical data

... for fan: RZR 15-0500

Installation acc. to DIN 24 163 part 1	:	B	
Flow rate (V)	:	5.20	m ³ /s
Total pressure (dpt)	:	960	Pa
Dyn. pressure (pd2) at discharge	:	100	Pa
Static pressure (dpfa)	:	860	Pa
Pressure losses (pv) at intake	:	100	Pa
Reference density (Rho1)	:	1.20	kg/m ³
Temperature t of the gas (t)	:	20	°C
Speed (n _v)	:	1764	1/min ^{1.)}
Power on shaft (Pw)	:	6.65	kW
Efficiency (ETA _t)	:	75	%
Fan weight	:	94	kg
A-Sound power level LwA _{4,7}	:	90	dB

1.) Fan speed tolerances of ±4% may occur when calculating the belt drive. This may cause technical data being slightly different to the values above.

unweighted	63 Hz	:	93/80	dB ^{2.)}
	125 Hz	:	88/83	dB
Octave sound power level	250 Hz	:	86/82	dB
acc. to discharge/intake	500 Hz	:	87/89	dB
LwOkt _{4,7} at	1000 Hz	:	85/85	dB
Octave band frequency	2000 Hz	:	81/82	dB
	4000 Hz	:	76/77	dB
	8000 Hz	:	67/69	dB

2.) The octave sound power levels can reach unpredictable higher values than calculated in the octave band of the blade passing frequencies.

... for motor: 160M-4

Size	:	160M-4
Speed	:	1460 rpm
Power	:	11 kW
Voltage/Frequency	:	400/690/50 V/Hz
Electric current	:	21.5/12.4 A

Customer : **MJL**
Reference : **British Museum - WCEC**
Item No : **AHU/05/01 Extract**

Date : **06.06.2012**
Made by : **Jim Picken**
Page : **2**

Fan curves: RZR 15-0500

Basis:

Reference density (Rho1) : 1.20 kg/m³
Install: B

Total pressure [Pa]

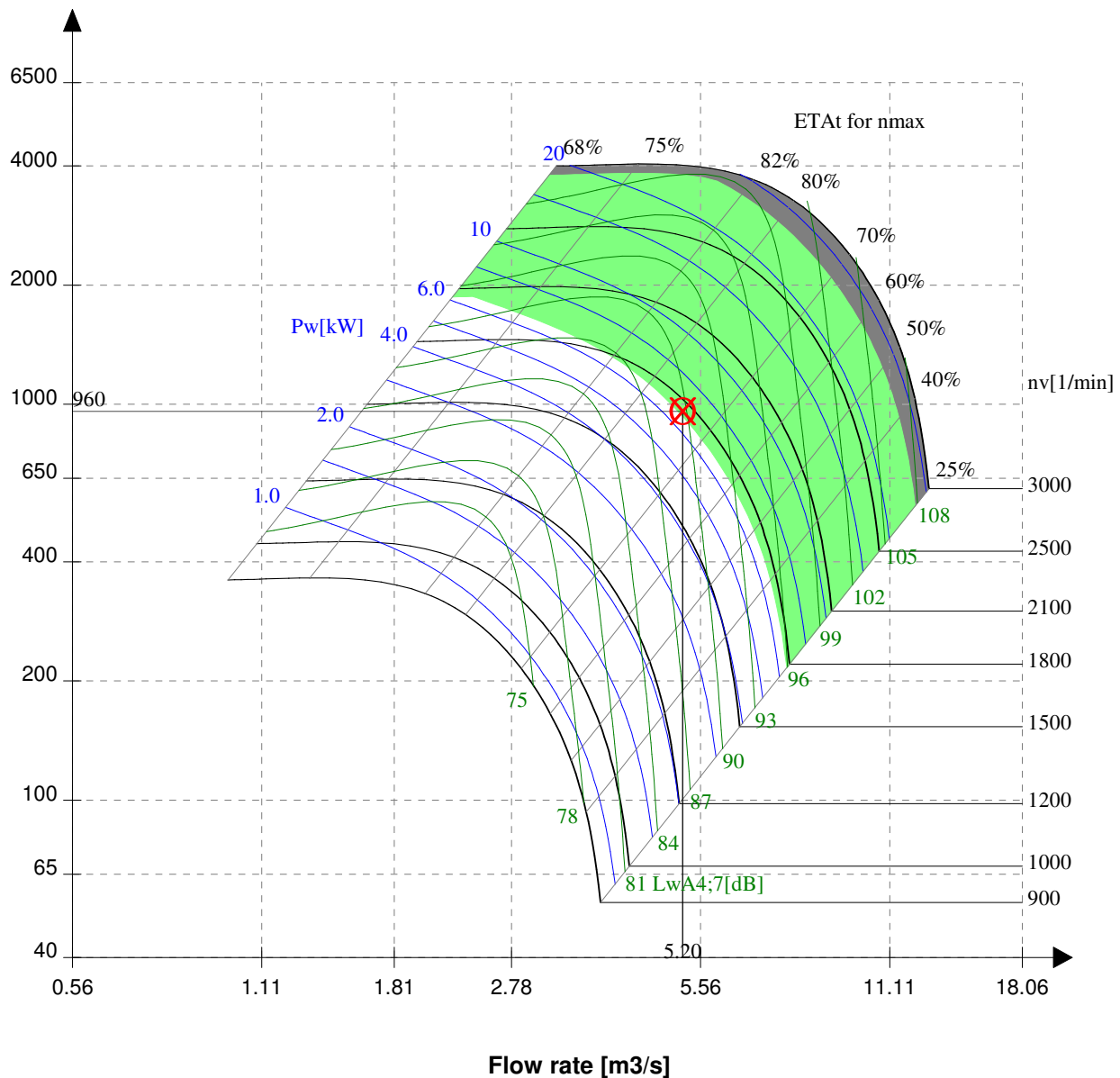

- RZR 13-/15-/18-/19-... only
- Do not use in this area

Customer : **MJL**
Reference : **British Museum - WCEC**
Item No : **AHU/05/02 Supply**

Date : **06.06.2012**
Made by : **Jim Picken**
Page : **1**

Technical data

... for fan: RZR 15-0400

Installation acc. to DIN 24 163 part 1	:	B
Flow rate (V)	:	3.10 m ³ /s
Total pressure (dpt)	:	1299 Pa
Dyn. pressure (pd2) at discharge	:	89 Pa
Static pressure (dpfa)	:	1210 Pa
Pressure losses (pv) at intake	:	0 Pa
Reference density (Rho1)	:	1.20 kg/m ³
Temperature t of the gas (t)	:	20 °C
Speed (n _v)	:	2401 1/min ^{1.)}
Power on shaft (Pw)	:	5.09 kW
Efficiency (ETA _t)	:	79 %
Fan weight	:	61 kg
A-Sound power level LwA _{4,7}	:	90 dB

1.) Fan speed tolerances of ±4% may occur when calculating the belt drive. This may cause technical data being slightly different to the values above.

unweighted	63 Hz	:	97/83 dB ^{2.)}
	125 Hz	:	91/86 dB
Octave sound power level	250 Hz	:	88/85 dB
acc. to discharge/intake	500 Hz	:	87/89 dB
LwOkt _{4,7} at	1000 Hz	:	84/84 dB
Octave band frequency	2000 Hz	:	80/81 dB
	4000 Hz	:	75/76 dB
	8000 Hz	:	67/69 dB

2.) The octave sound power levels can reach unpredictable higher values than calculated in the octave band of the blade passing frequencies.

... for motor: 132Sb-2

Size	:	132Sb-2
Speed	:	2930 rpm
Power	:	7,5 kW
Voltage/Frequency	:	400/690/50 V/Hz
Electric current	:	13.8/8 A

Customer : **MJL**
Reference : **British Museum - WCEC**
Item No : **AHU/05/02 Supply**

Date : **06.06.2012**
Made by : **Jim Picken**
Page : **2**

Fan curves: RZR 15-0400

Basis:

Reference density (Rho1) : 1.20 kg/m³
Install: B

Total pressure [Pa]

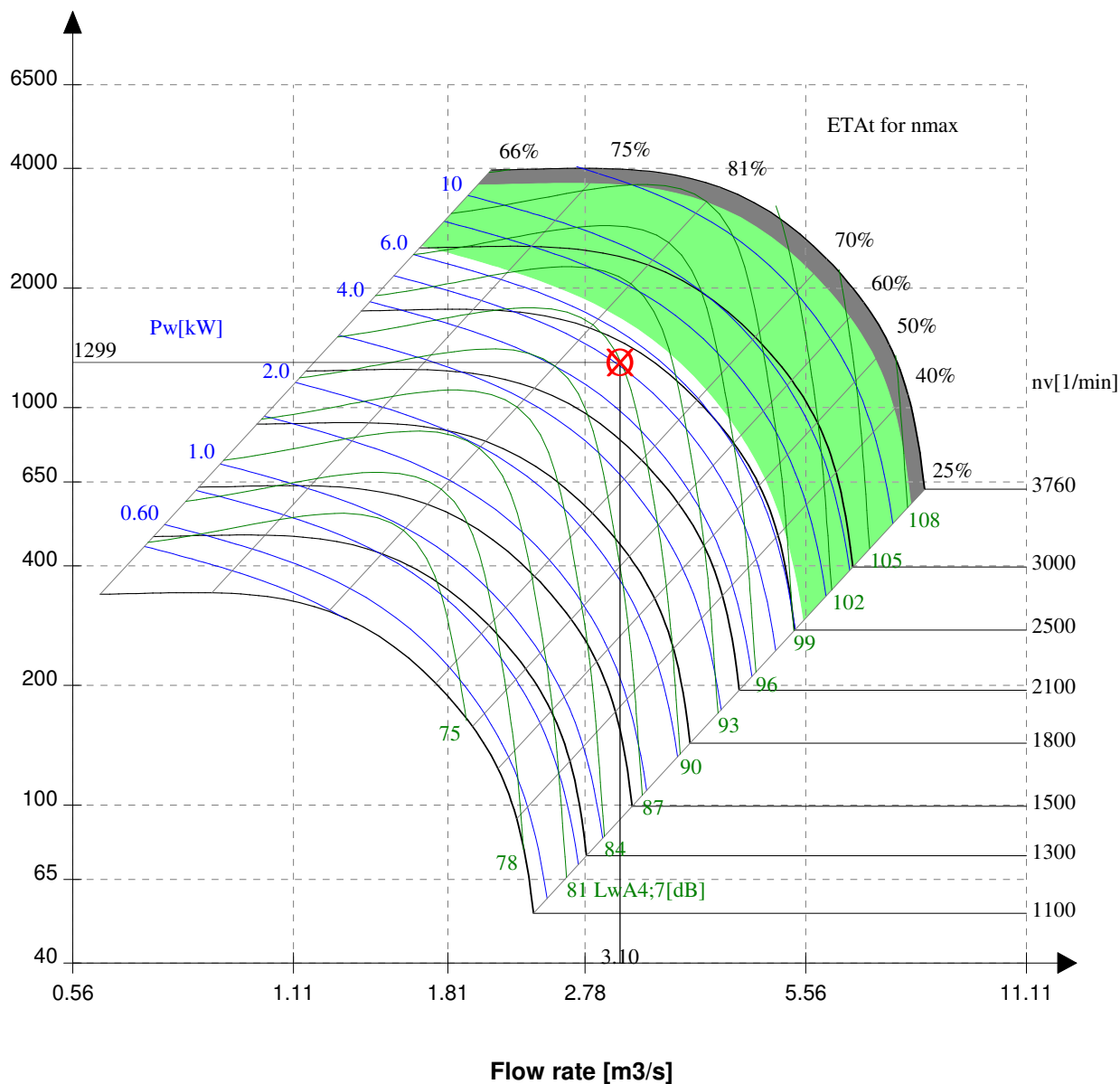

RZR 13-/15-/18-/19-... only
 Do not use in this area

Customer : **MJL**
Reference : **British Museum - WCEC**
Item No : **AHU/05/02 Extract**

Date : **06.06.2012**
Made by : **Jim Picken**
Page : **1**

Technical data

... for fan: RZR 11-0400

Installation acc. to DIN 24 163 part 1	:	B
Flow rate (V)	:	3.10 m ³ /s
Total pressure (dpt)	:	929 Pa
Dyn. pressure (pd2) at discharge	:	89 Pa
Static pressure (dpfa)	:	839 Pa
Pressure losses (pv) at intake	:	89 Pa
Reference density (Rho1)	:	1.20 kg/m ³
Temperature t of the gas (t)	:	20 °C
Speed (n _v)	:	2167 1/min ^{1.)}
Power on shaft (Pw)	:	3.83 kW
Efficiency (ETA _t)	:	75 %
Fan weight	:	43 kg
A-Sound power level LwA _{4,7}	:	89 dB

1.) Fan speed tolerances of ±4% may occur when calculating the belt drive. This may cause technical data being slightly different to the values above.

unweighted	63 Hz	:	92/79 dB ^{2.)}
	125 Hz	:	87/82 dB
Octave sound power level	250 Hz	:	85/81 dB
acc. to discharge/intake	500 Hz	:	86/88 dB
LwOkt _{4,7} at	1000 Hz	:	84/84 dB
Octave band frequency	2000 Hz	:	80/81 dB
	4000 Hz	:	75/76 dB
	8000 Hz	:	66/68 dB

2.) The octave sound power levels can reach unpredictable higher values than calculated in the octave band of the blade passing frequencies.

... for motor: 132S-4

Size	:	132S-4
Speed	:	1455 rpm
Power	:	5,5 kW
Voltage/Frequency	:	400/690/50 V/Hz
Electric current	:	11.4/6.6 A

Customer : **MJL**
Reference : **British Museum - WCEC**
Item No : **AHU/05/02 Extract**

Date : **06.06.2012**
Made by : **Jim Picken**
Page : **2**

Fan curves: RZR 11-0400

Basis:

Reference density (Rho1) : 1.20 kg/m³
Install: B

Total pressure [Pa]

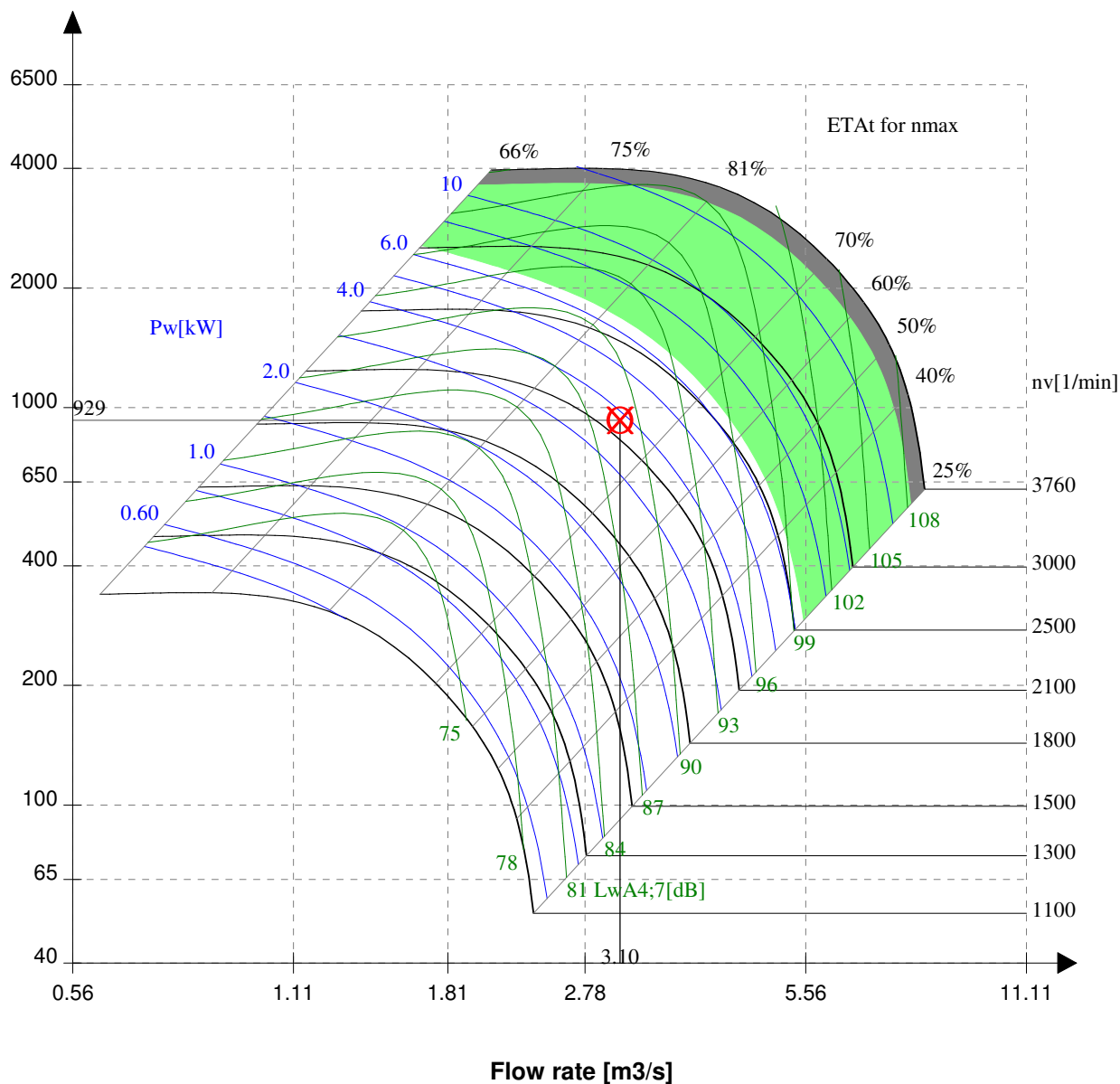

- RZR 13-/15-/18-/19-... only
- Do not use in this area

Customer : **MJL**
Reference : **British Museum - WCEC**
Item No : **AHU/05/03 & AHU/05/07 Supply**

Date : **06.06.2012**
Made by : **Jim Picken**
Page : **1**

Technical data

... for fan: RZR 15-0500

Installation acc. to DIN 24 163 part 1	:	B
Flow rate (V)	:	4.20 m ³ /s
Total pressure (dpt)	:	1375 Pa
Dyn. pressure (pd2) at discharge	:	65 Pa
Static pressure (dpfa)	:	1310 Pa
Pressure losses (pv) at intake	:	0 Pa
Reference density (Rho1)	:	1.20 kg/m ³
Temperature t of the gas (t)	:	20 °C
Speed (n _v)	:	1839 1/min ^{1.)}
Power on shaft (Pw)	:	7.08 kW
Efficiency (ETA _t)	:	82 %
Fan weight	:	94 kg
A-Sound power level LwA _{4,7}	:	87 dB

1.) Fan speed tolerances of ±4% may occur when calculating the belt drive. This may cause technical data being slightly different to the values above.

unweighted	63 Hz	:	94/80 dB ^{2.)}
	125 Hz	:	88/83 dB
Octave sound power level	250 Hz	:	85/82 dB
acc. to discharge/intake	500 Hz	:	84/86 dB
LwOkt _{4,7} at	1000 Hz	:	81/81 dB
Octave band frequency	2000 Hz	:	77/78 dB
	4000 Hz	:	72/73 dB
	8000 Hz	:	64/66 dB

2.) The octave sound power levels can reach unpredictable higher values than calculated in the octave band of the blade passing frequencies.

... for motor: 160M-4

Size	:	160M-4
Speed	:	1460 rpm
Power	:	11 kW
Voltage/Frequency	:	400/690/50 V/Hz
Electric current	:	21.5/12.4 A

Customer : **MJL**
Reference : **British Museum - WCEC**
Item No : **AHU/05/03 & AHU/05/07 Supply**

Date : **06.06.2012**
Made by : **Jim Picken**
Page : **2**

Fan curves: RZR 15-0500

Basis:

Reference density (Rho1) : 1.20 kg/m³
Install: B

Total pressure [Pa]

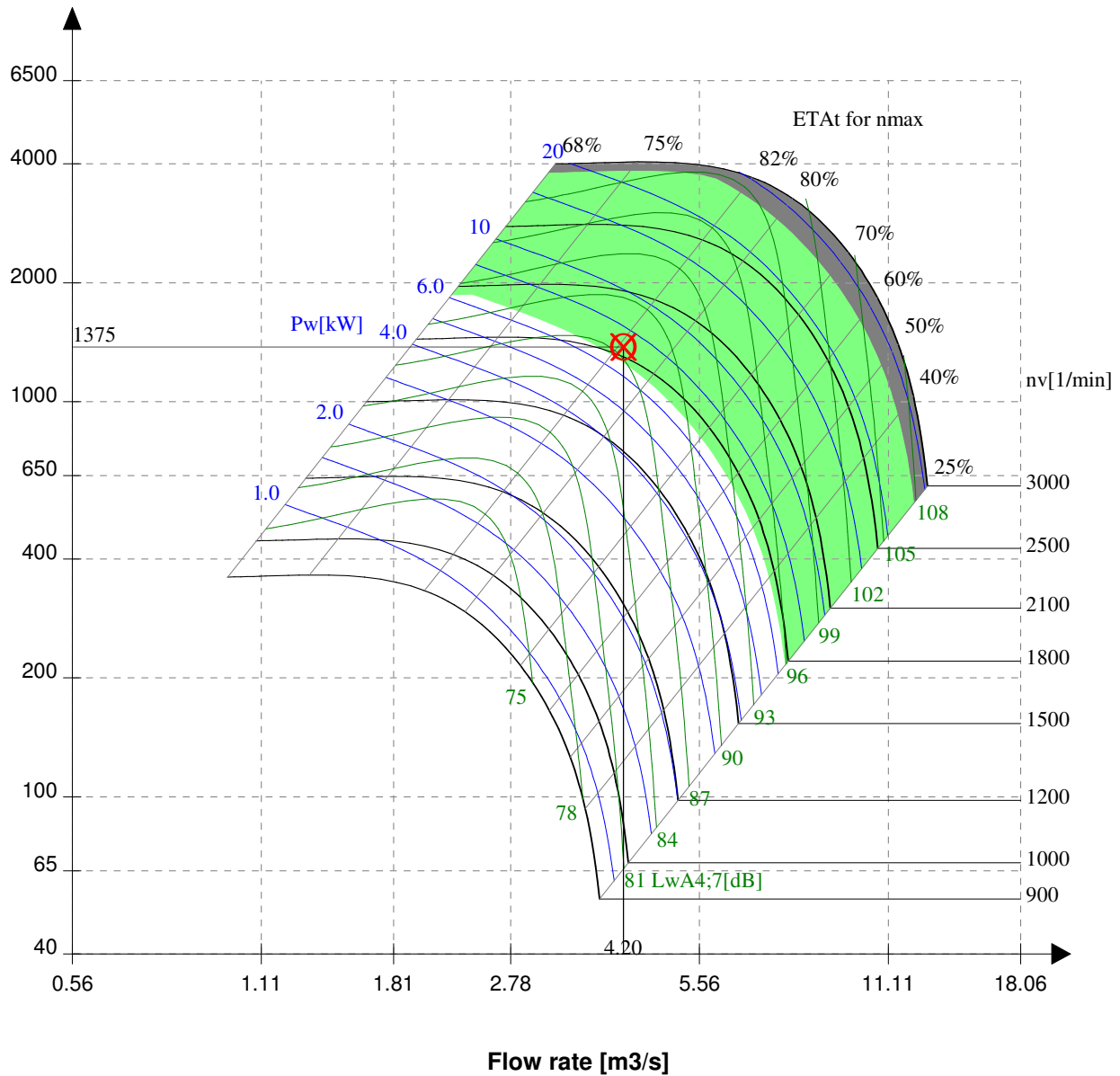

RZR 13-/15-/18-/19-... only
 Do not use in this area

Customer : **MJL**
Reference : **British Museum - WCEC**
Item No : **AHU/05/03 & AHU/05/07 Extract**

Date : **06.06.2012**
Made by : **Jim Picken**
Page : **1**

Technical data

... for fan: RZR 15-0500

Installation acc. to DIN 24 163 part 1	:	B
Flow rate (V)	:	4.20 m ³ /s
Total pressure (dpt)	:	960 Pa
Dyn. pressure (pd2) at discharge	:	65 Pa
Static pressure (dpfa)	:	895 Pa
Pressure losses (pv) at intake	:	65 Pa
Reference density (Rho1)	:	1.20 kg/m ³
Temperature t of the gas (t)	:	20 °C
Speed (n _v)	:	1621 1/min ^{1.)}
Power on shaft (Pw)	:	5.05 kW
Efficiency (ETA _t)	:	80 %
Fan weight	:	94 kg
A-Sound power level LwA _{4,7}	:	86 dB

1.) Fan speed tolerances of ±4% may occur when calculating the belt drive. This may cause technical data being slightly different to the values above.

unweighted	63 Hz	:	93/79 dB ^{2.)}
	125 Hz	:	87/82 dB
Octave sound power level	250 Hz	:	84/81 dB
acc. to discharge/intake	500 Hz	:	83/85 dB
LwOkt _{4,7} at	1000 Hz	:	80/80 dB
Octave band frequency	2000 Hz	:	76/77 dB
	4000 Hz	:	71/72 dB
	8000 Hz	:	63/65 dB

2.) The octave sound power levels can reach unpredictable higher values than calculated in the octave band of the blade passing frequencies.

... for motor: 132M-4

Size	:	132M-4
Speed	:	1455 rpm
Power	:	7,5 kW
Voltage/Frequency	:	400/690/50 V/Hz
Electric current	:	15.2/8.8 A

Customer : **MJL**
Reference : **British Museum - WCEC**
Item No : **AHU/05/03 & AHU/05/07 Extract**

Date : **06.06.2012**
Made by : **Jim Picken**
Page : **2**

Fan curves: RZR 15-0500

Basis:

Reference density (Rho1) : 1.20 kg/m³
Install: B

Total pressure [Pa]

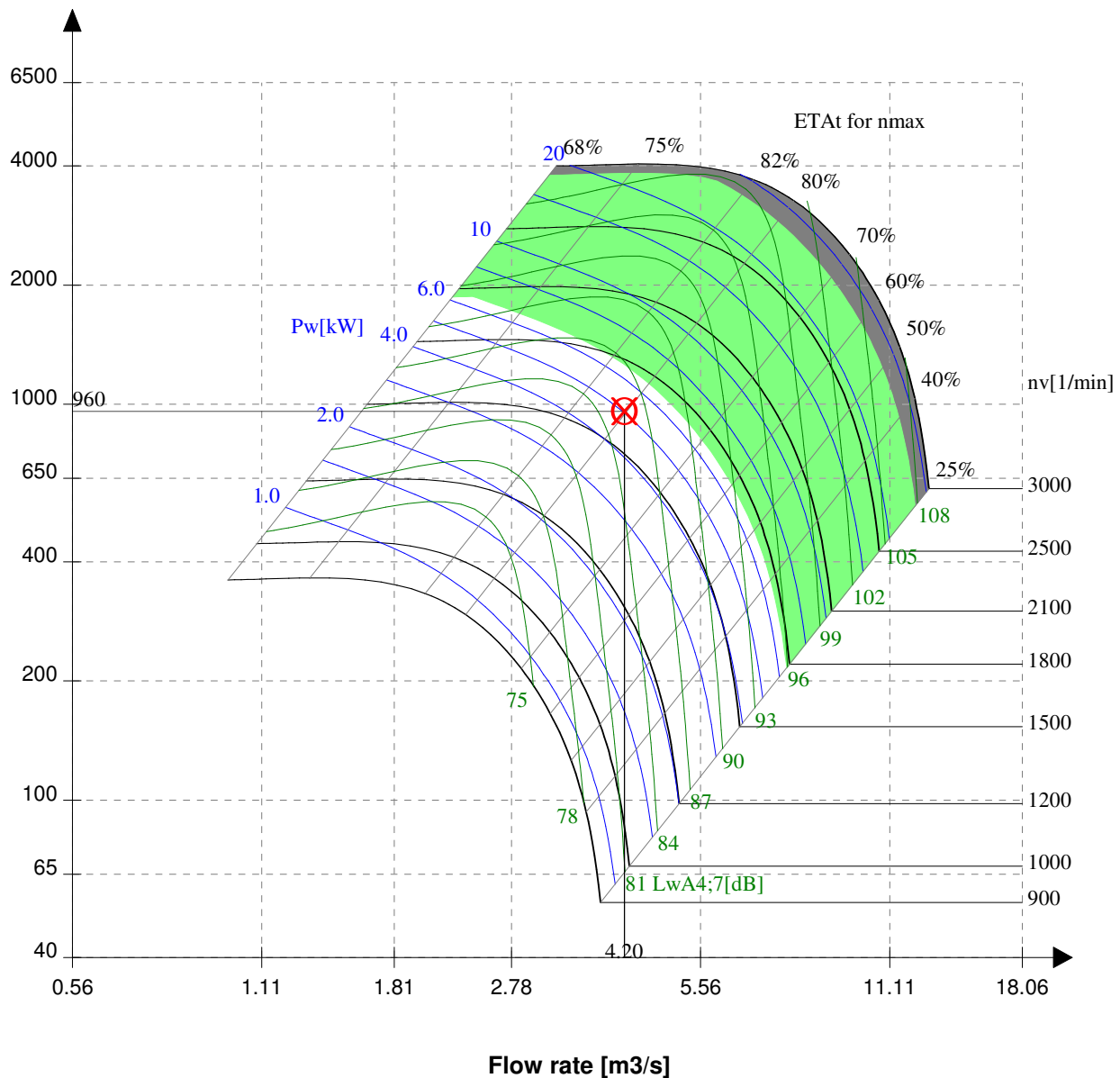

- RZR 13-/15-/18-/19-... only
- Do not use in this area

Customer : **MJL**
Reference : **British Museum - WCEC**
Item No : **AHU/05/04 Supply**

Date : **06.06.2012**
Made by : **Jim Picken**
Page : **1**

Technical data

... for fan: RZR 15-0500

Installation acc. to DIN 24 163 part 1	:	B
Flow rate (V)	:	3.80 m ³ /s
Total pressure (dpt)	:	1403 Pa
Dyn. pressure (pd2) at discharge	:	53 Pa
Static pressure (dpfa)	:	1350 Pa
Pressure losses (pv) at intake	:	0 Pa
Reference density (Rho1)	:	1.20 kg/m ³
Temperature t of the gas (t)	:	20 °C
Speed (n _v)	:	1816 1/min ^{1.)}
Power on shaft (Pw)	:	6.56 kW
Efficiency (ETA _t)	:	81 %
Fan weight	:	94 kg
A-Sound power level LwA _{4,7}	:	87 dB

1.) Fan speed tolerances of ±4% may occur when calculating the belt drive. This may cause technical data being slightly different to the values above.

unweighted	63 Hz	:	94/80 dB ^{2.)}
	125 Hz	:	88/83 dB
Octave sound power level	250 Hz	:	85/82 dB
acc. to discharge/intake	500 Hz	:	84/86 dB
LwOkt _{4,7} at	1000 Hz	:	81/81 dB
Octave band frequency	2000 Hz	:	77/78 dB
	4000 Hz	:	72/73 dB
	8000 Hz	:	64/66 dB

2.) The octave sound power levels can reach unpredictable higher values than calculated in the octave band of the blade passing frequencies.

... for motor: 160M-4

Size	:	160M-4
Speed	:	1460 rpm
Power	:	11 kW
Voltage/Frequency	:	400/690/50 V/Hz
Electric current	:	21.5/12.4 A

Customer : **MJL**
Reference : **British Museum - WCEC**
Item No : **AHU/05/04 Supply**

Date : **06.06.2012**
Made by : **Jim Picken**
Page : **2**

Fan curves: RZR 15-0500

Basis:

Reference density (Rho1) : 1.20 kg/m³
Install: B

Total pressure [Pa]

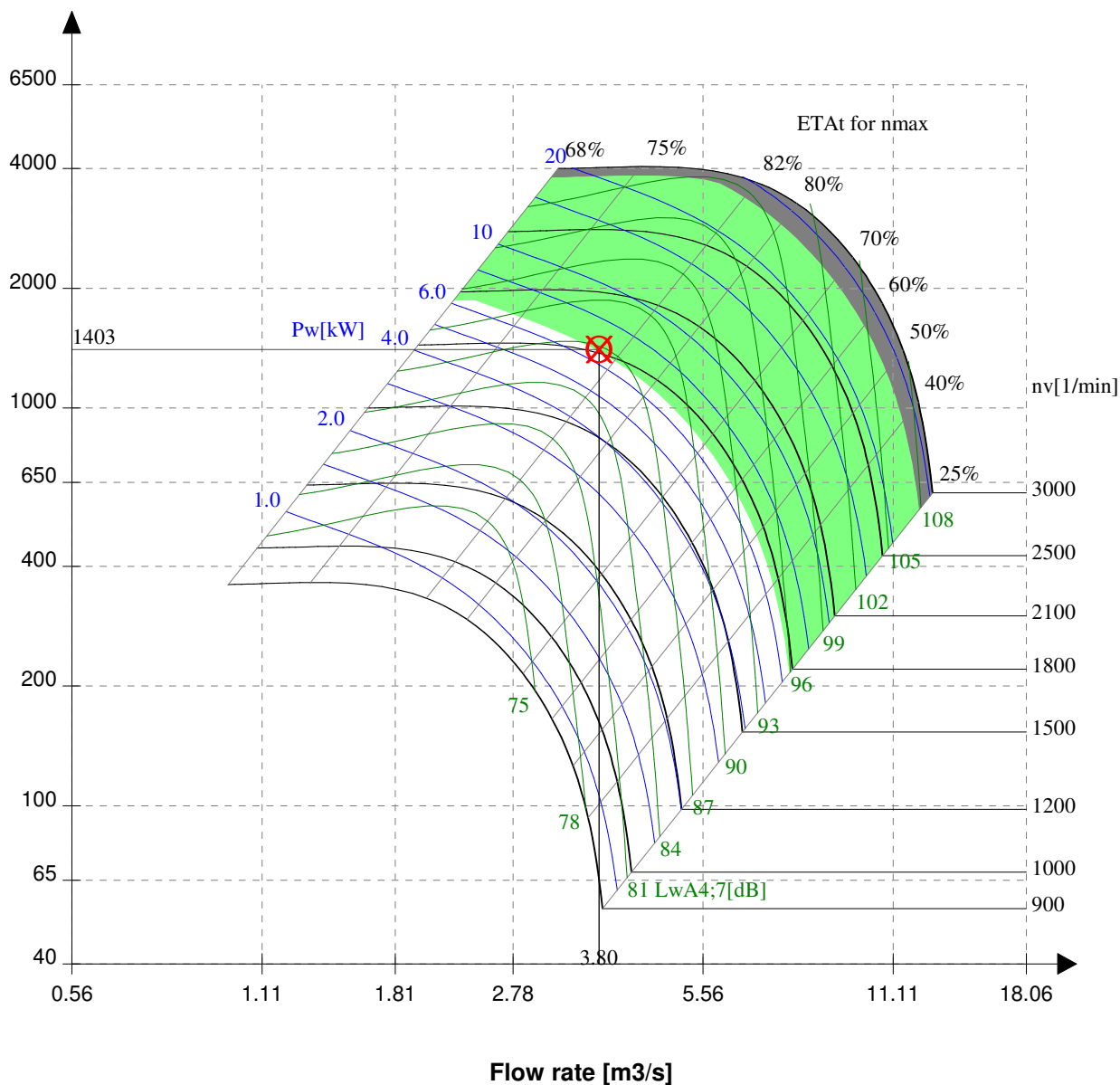

RZR 13-/15-/18-/19-... only
 Do not use in this area

Customer : **MJL**
Reference : **British Museum - WCEC**
Item No : **AHU/05/04 Extract**

Date : **06.06.2012**
Made by : **Jim Picken**
Page : **1**

Technical data

... for fan: RZR 15-0500

Installation acc. to DIN 24 163 part 1	:	B
Flow rate (V)	:	3.80 m ³ /s
Total pressure (dpt)	:	907 Pa
Dyn. pressure (pd ₂) at discharge	:	53 Pa
Static pressure (dpfa)	:	853 Pa
Pressure losses (pv) at intake	:	53 Pa
Reference density (Rho ₁)	:	1.20 kg/m ³
Temperature t of the gas (t)	:	20 °C
Speed (n _v)	:	1539 1/min ^{1.)}
Power on shaft (Pw)	:	4.27 kW
Efficiency (ETA _t)	:	81 %
Fan weight	:	94 kg
A-Sound power level LwA _{4,7}	:	84 dB

1.) Fan speed tolerances of ±4% may occur when calculating the belt drive. This may cause technical data being slightly different to the values above.

unweighted	63 Hz	:	91/77 dB ^{2.)}
	125 Hz	:	85/80 dB
Octave sound power level	250 Hz	:	82/79 dB
acc. to discharge/intake	500 Hz	:	81/83 dB
LwOkt _{4,7} at	1000 Hz	:	78/78 dB
Octave band frequency	2000 Hz	:	74/75 dB
	4000 Hz	:	69/70 dB
	8000 Hz	:	61/63 dB

2.) The octave sound power levels can reach unpredictable higher values than calculated in the octave band of the blade passing frequencies.

... for motor: 132M-4

Size	:	132M-4
Speed	:	1455 rpm
Power	:	7,5 kW
Voltage/Frequency	:	400/690/50 V/Hz
Electric current	:	15.2/8.8 A

Customer : **MJL**
Reference : **British Museum - WCEC**
Item No : **AHU/05/04 Extract**

Date : **06.06.2012**
Made by : **Jim Picken**
Page : **2**

Fan curves: RZR 15-0500

Basis:

Reference density (Rho1) : 1.20 kg/m³
Install: B

Total pressure [Pa]

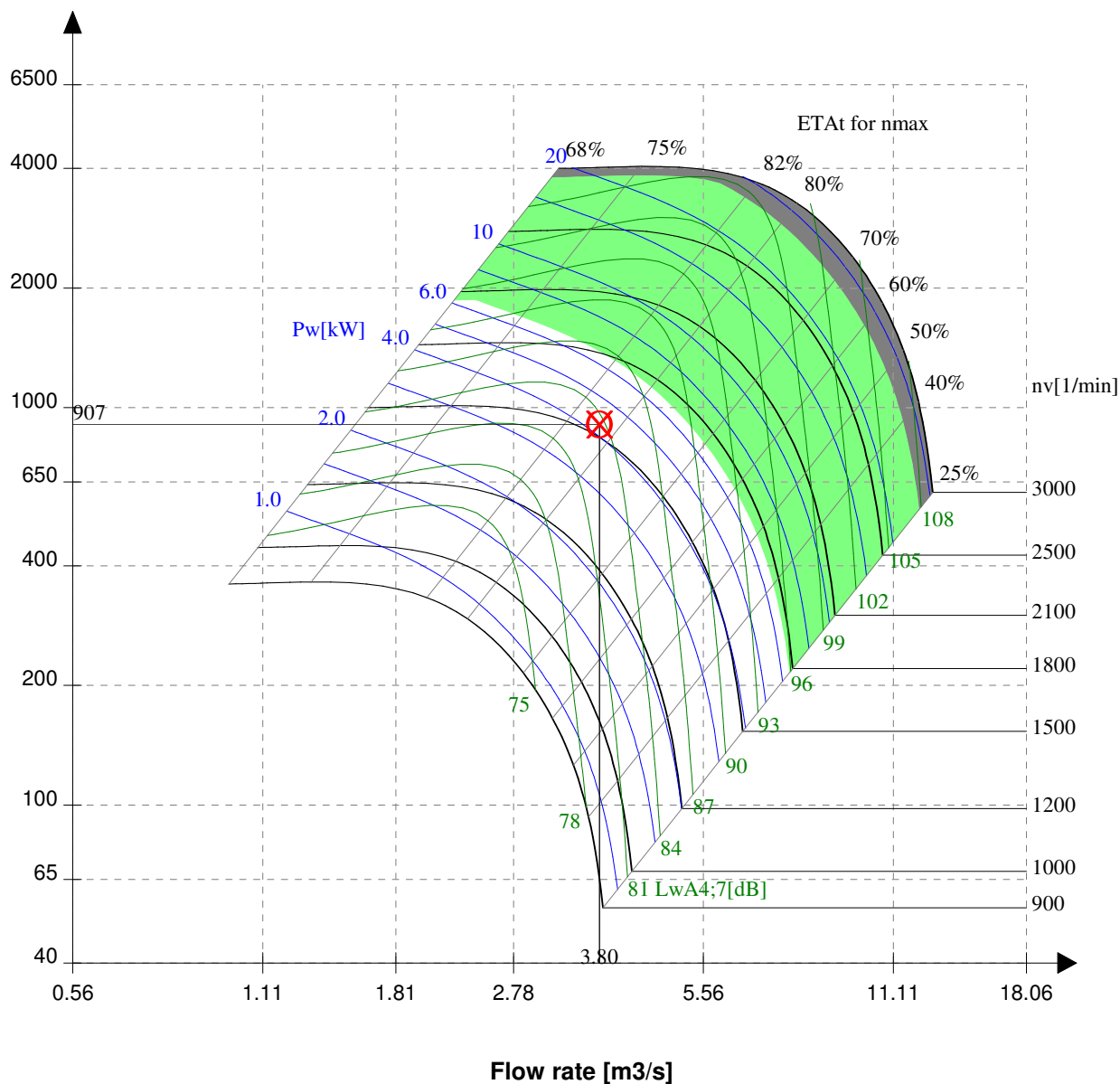

RZR 13-/15-/18-/19-... only
 Do not use in this area

Customer : **MJL**
Reference : **British Museum - WCEC**
Item No : **AHU/05/05 Supply**

Date : **06.06.2012**
Made by : **Jim Picken**
Page : **1**

Technical data

... for fan: RZR 15-0500

Installation acc. to DIN 24 163 part 1	:	B
Flow rate (V)	:	3.85 m ³ /s
Total pressure (dpt)	:	1415 Pa
Dyn. pressure (pd2) at discharge	:	55 Pa
Static pressure (dpfa)	:	1360 Pa
Pressure losses (pv) at intake	:	0 Pa
Reference density (Rho1)	:	1.20 kg/m ³
Temperature t of the gas (t)	:	20 °C
Speed (n _v)	:	1826 1/min ^{1.)}
Power on shaft (Pw)	:	6.70 kW
Efficiency (ETA _t)	:	81 %
Fan weight	:	94 kg
A-Sound power level LwA _{4,7}	:	87 dB

1.) Fan speed tolerances of ±4% may occur when calculating the belt drive. This may cause technical data being slightly different to the values above.

	63 Hz	:	94/80 dB ^{2.)}
unweighted	125 Hz	:	88/83 dB
Octave sound power level	250 Hz	:	85/82 dB
acc. to discharge/intake	500 Hz	:	84/86 dB
LwOkt _{4,7} at	1000 Hz	:	81/81 dB
Octave band frequency	2000 Hz	:	77/78 dB
	4000 Hz	:	72/73 dB
	8000 Hz	:	64/66 dB

2.) The octave sound power levels can reach unpredictable higher values than calculated in the octave band of the blade passing frequencies.

... for motor: 160M-4

Size	:	160M-4
Speed	:	1460 rpm
Power	:	11 kW
Voltage/Frequency	:	400/690/50 V/Hz
Electric current	:	21.5/12.4 A

Customer : **MJL**
Reference : **British Museum - WCEC**
Item No : **AHU/05/05 Supply**

Date : **06.06.2012**
Made by : **Jim Picken**
Page : **2**

Fan curves: RZR 15-0500

Basis:

Reference density (Rho1) : 1.20 kg/m³
Install: B

Total pressure [Pa]

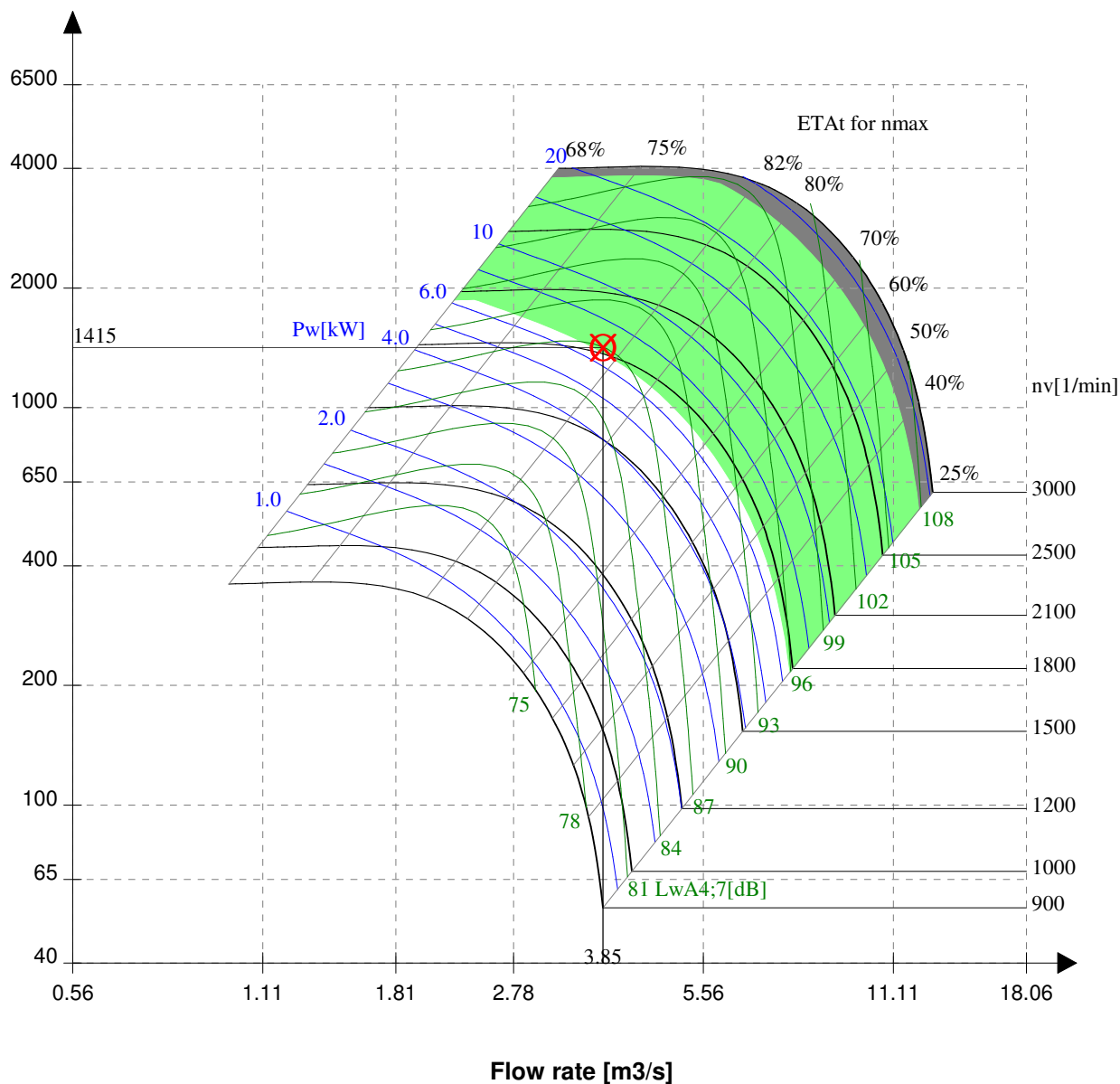

RZR 13-/15-/18-/19-... only
 Do not use in this area

Customer : **MJL**
Reference : **British Museum - WCEC**
Item No : **AHU/05/05 Extract**

Date : **06.06.2012**
Made by : **Jim Picken**
Page : **1**

Technical data

... for fan: RZR 15-0500

Installation acc. to DIN 24 163 part 1	:	B
Flow rate (V)	:	3.85 m ³ /s
Total pressure (dpt)	:	909 Pa
Dyn. pressure (pd2) at discharge	:	55 Pa
Static pressure (dpfa)	:	855 Pa
Pressure losses (pv) at intake	:	55 Pa
Reference density (Rho1)	:	1.20 kg/m ³
Temperature t of the gas (t)	:	20 °C
Speed (n _v)	:	1547 1/min ^{1.)}
Power on shaft (Pw)	:	4.34 kW
Efficiency (ETA _t)	:	81 %
Fan weight	:	94 kg
A-Sound power level LwA _{4,7}	:	84 dB

1.) Fan speed tolerances of ±4% may occur when calculating the belt drive. This may cause technical data being slightly different to the values above.

unweighted	63 Hz	:	91/77 dB ^{2.)}
	125 Hz	:	85/80 dB
Octave sound power level	250 Hz	:	82/79 dB
acc. to discharge/intake	500 Hz	:	81/83 dB
LwOkt _{4,7} at	1000 Hz	:	78/78 dB
Octave band frequency	2000 Hz	:	74/75 dB
	4000 Hz	:	69/70 dB
	8000 Hz	:	61/63 dB

2.) The octave sound power levels can reach unpredictable higher values than calculated in the octave band of the blade passing frequencies.

... for motor: 132M-4

Size	:	132M-4
Speed	:	1455 rpm
Power	:	7,5 kW
Voltage/Frequency	:	400/690/50 V/Hz
Electric current	:	15.2/8.8 A

Customer : **MJL**
Reference : **British Museum - WCEC**
Item No : **AHU/05/05 Extract**

Date : **06.06.2012**
Made by : **Jim Picken**
Page : **2**

Fan curves: RZR 15-0500

Basis:

Reference density (Rho1) : 1.20 kg/m³
Install: B

Total pressure [Pa]

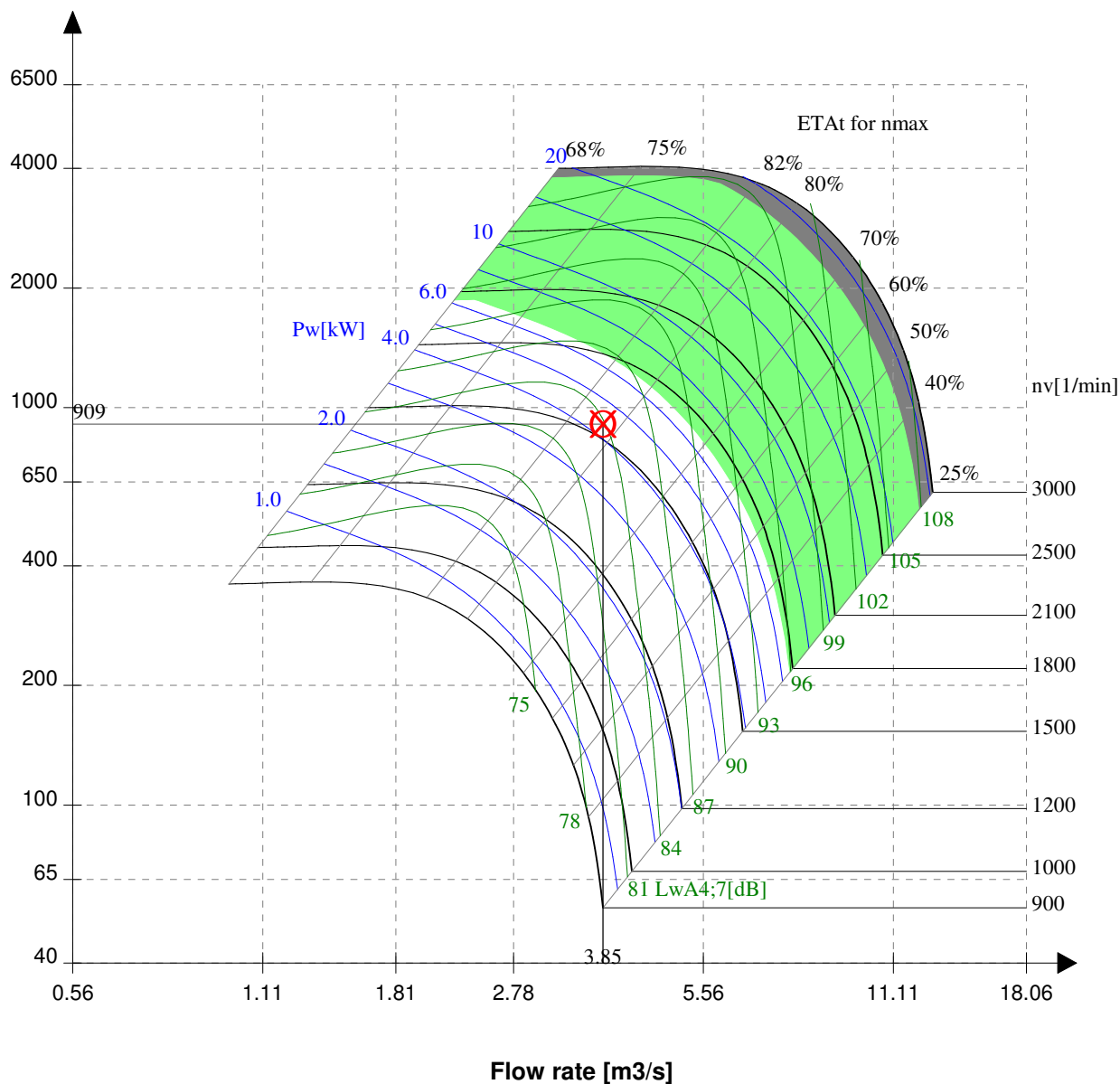

■ RZR 13-/15-/18-/19-... only
■ Do not use in this area

Customer : **MJL**
Reference : **British Museum - WCEC**
Item No : **AHU/05/06 Supply**

Date : **06.06.2012**
Made by : **Jim Picken**
Page : **1**

Technical data

... for fan: RZR 15-0500

Installation acc. to DIN 24 163 part 1	:	B
Flow rate (V)	:	4.00 m ³ /s
Total pressure (dpt)	:	1339 Pa
Dyn. pressure (pd2) at discharge	:	59 Pa
Static pressure (dpfa)	:	1280 Pa
Pressure losses (pv) at intake	:	0 Pa
Reference density (Rho1)	:	1.20 kg/m ³
Temperature t of the gas (t)	:	20 °C
Speed (n _v)	:	1800 1/min ^{1.)}
Power on shaft (Pw)	:	6.57 kW
Efficiency (ETA _t)	:	82 %
Fan weight	:	94 kg
A-Sound power level LwA _{4,7}	:	87 dB

1.) Fan speed tolerances of ±4% may occur when calculating the belt drive. This may cause technical data being slightly different to the values above.

unweighted	63 Hz	:	94/80 dB ^{2.)}
	125 Hz	:	88/83 dB
Octave sound power level	250 Hz	:	85/82 dB
acc. to discharge/intake	500 Hz	:	84/86 dB
LwOkt _{4,7} at	1000 Hz	:	81/81 dB
Octave band frequency	2000 Hz	:	77/78 dB
	4000 Hz	:	72/73 dB
	8000 Hz	:	64/66 dB

2.) The octave sound power levels can reach unpredictable higher values than calculated in the octave band of the blade passing frequencies.

... for motor: 160M-4

Size	:	160M-4
Speed	:	1460 rpm
Power	:	11 kW
Voltage/Frequency	:	400/690/50 V/Hz
Electric current	:	21.5/12.4 A

Customer : **MJL**
Reference : **British Museum - WCEC**
Item No : **AHU/05/06 Supply**

Date : **06.06.2012**
Made by : **Jim Picken**
Page : **2**

Fan curves: RZR 15-0500

Basis:

Reference density (Rho1) : 1.20 kg/m³
Install: B

Total pressure [Pa]

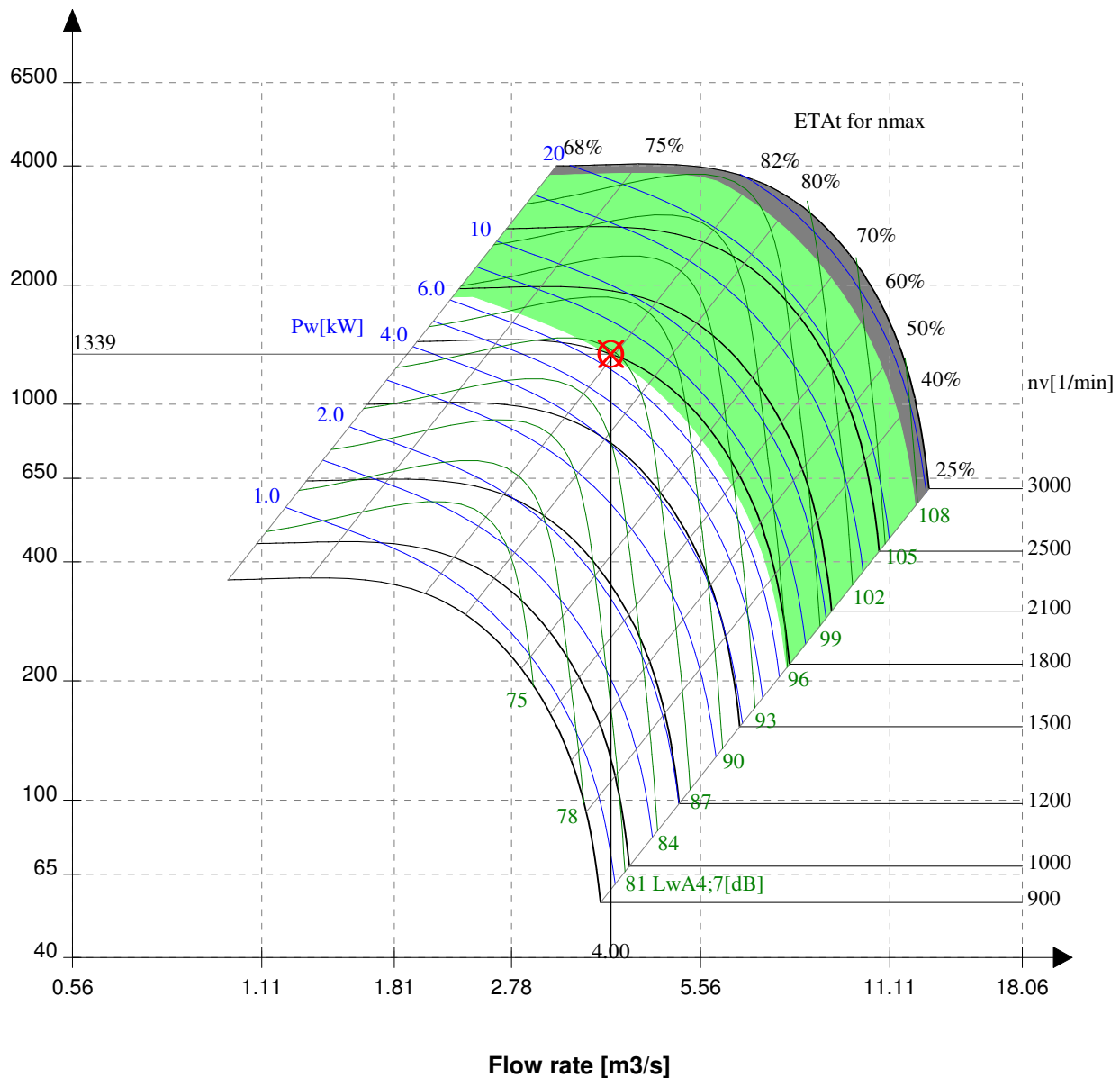

RZR 13-/15-/18-/19-... only
 Do not use in this area

Customer : **MJL**
Reference : **British Museum - WCEC**
Item No : **AHU/05/06 Extract**

Date : **06.06.2012**
Made by : **Jim Picken**
Page : **1**

Technical data

... for fan: RZR 15-0500

Installation acc. to DIN 24 163 part 1	:	B
Flow rate (V)	:	4.00 m ³ /s
Total pressure (dpt)	:	938 Pa
Dyn. pressure (pd ₂) at discharge	:	59 Pa
Static pressure (dpfa)	:	879 Pa
Pressure losses (pv) at intake	:	59 Pa
Reference density (Rho1)	:	1.20 kg/m ³
Temperature t of the gas (t)	:	20 °C
Speed (n _v)	:	1582 1/min ^{1.)}
Power on shaft (Pw)	:	4.67 kW
Efficiency (ETA _t)	:	80 %
Fan weight	:	94 kg
A-Sound power level LwA _{4,7}	:	85 dB

1.) Fan speed tolerances of ±4% may occur when calculating the belt drive. This may cause technical data being slightly different to the values above.

unweighted	63 Hz	:	92/78 dB ^{2.)}
	125 Hz	:	86/81 dB
Octave sound power level	250 Hz	:	83/80 dB
acc. to discharge/intake	500 Hz	:	82/84 dB
LwOkt _{4,7} at	1000 Hz	:	79/79 dB
Octave band frequency	2000 Hz	:	75/76 dB
	4000 Hz	:	70/71 dB
	8000 Hz	:	62/64 dB

2.) The octave sound power levels can reach unpredictable higher values than calculated in the octave band of the blade passing frequencies.

... for motor: 132M-4

Size	:	132M-4
Speed	:	1455 rpm
Power	:	7,5 kW
Voltage/Frequency	:	400/690/50 V/Hz
Electric current	:	15.2/8.8 A

Customer : **MJL**
Reference : **British Museum - WCEC**
Item No : **AHU/05/06 Extract**

Date : **06.06.2012**
Made by : **Jim Picken**
Page : **2**

Fan curves: RZR 15-0500

Basis:

Reference density (Rho1) : 1.20 kg/m³
Install: B

Total pressure [Pa]

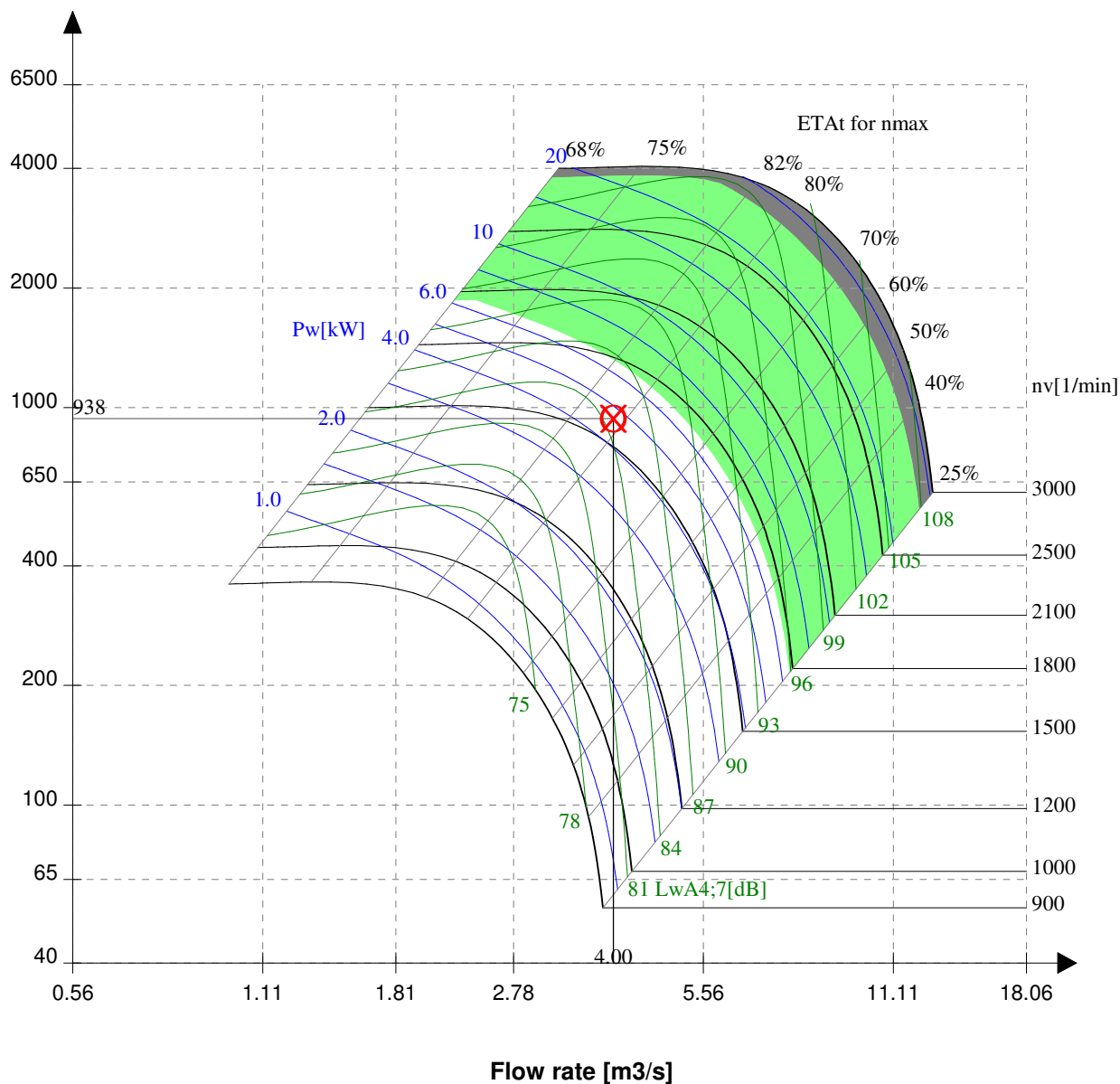

RZR 13-/15-/18-/19-... only
 Do not use in this area

Customer : **MJL**
Reference : **British Museum - WCEC**
Item No : **AHU/05/08 Supply**

Date : **06.06.2012**
Made by : **Jim Picken**
Page : **1**

Technical data

... for fan: RZR 15-0500

Installation acc. to DIN 24 163 part 1	:	B
Flow rate (V)	:	4.60 m ³ /s
Total pressure (dpt)	:	1418 Pa
Dyn. pressure (pd2) at discharge	:	78 Pa
Static pressure (dpfa)	:	1340 Pa
Pressure losses (pv) at intake	:	0 Pa
Reference density (Rho1)	:	1.20 kg/m ³
Temperature t of the gas (t)	:	20 °C
Speed (n _v)	:	1906 1/min ^{1.)}
Power on shaft (Pw)	:	8.03 kW
Efficiency (ETA _t)	:	81 %
Fan weight	:	94 kg
A-Sound power level LwA _{4,7}	:	89 dB

1.) Fan speed tolerances of ±4% may occur when calculating the belt drive. This may cause technical data being slightly different to the values above.

unweighted	63 Hz	:	96/82 dB ^{2.)}
	125 Hz	:	90/85 dB
Octave sound power level	250 Hz	:	87/84 dB
acc. to discharge/intake	500 Hz	:	86/88 dB
LwOkt _{4,7} at	1000 Hz	:	83/83 dB
Octave band frequency	2000 Hz	:	79/80 dB
	4000 Hz	:	74/75 dB
	8000 Hz	:	66/68 dB

2.) The octave sound power levels can reach unpredictable higher values than calculated in the octave band of the blade passing frequencies.

... for motor: 160M-4

Size	:	160M-4
Speed	:	1460 rpm
Power	:	11 kW
Voltage/Frequency	:	400/690/50 V/Hz
Electric current	:	21.5/12.4 A

Customer : **MJL**
Reference : **British Museum - WCEC**
Item No : **AHU/05/08 Supply**

Date : **06.06.2012**
Made by : **Jim Picken**
Page : **2**

Fan curves: RZR 15-0500

Basis:

Reference density (Rho1) : 1.20 kg/m³
Install: B

Total pressure [Pa]

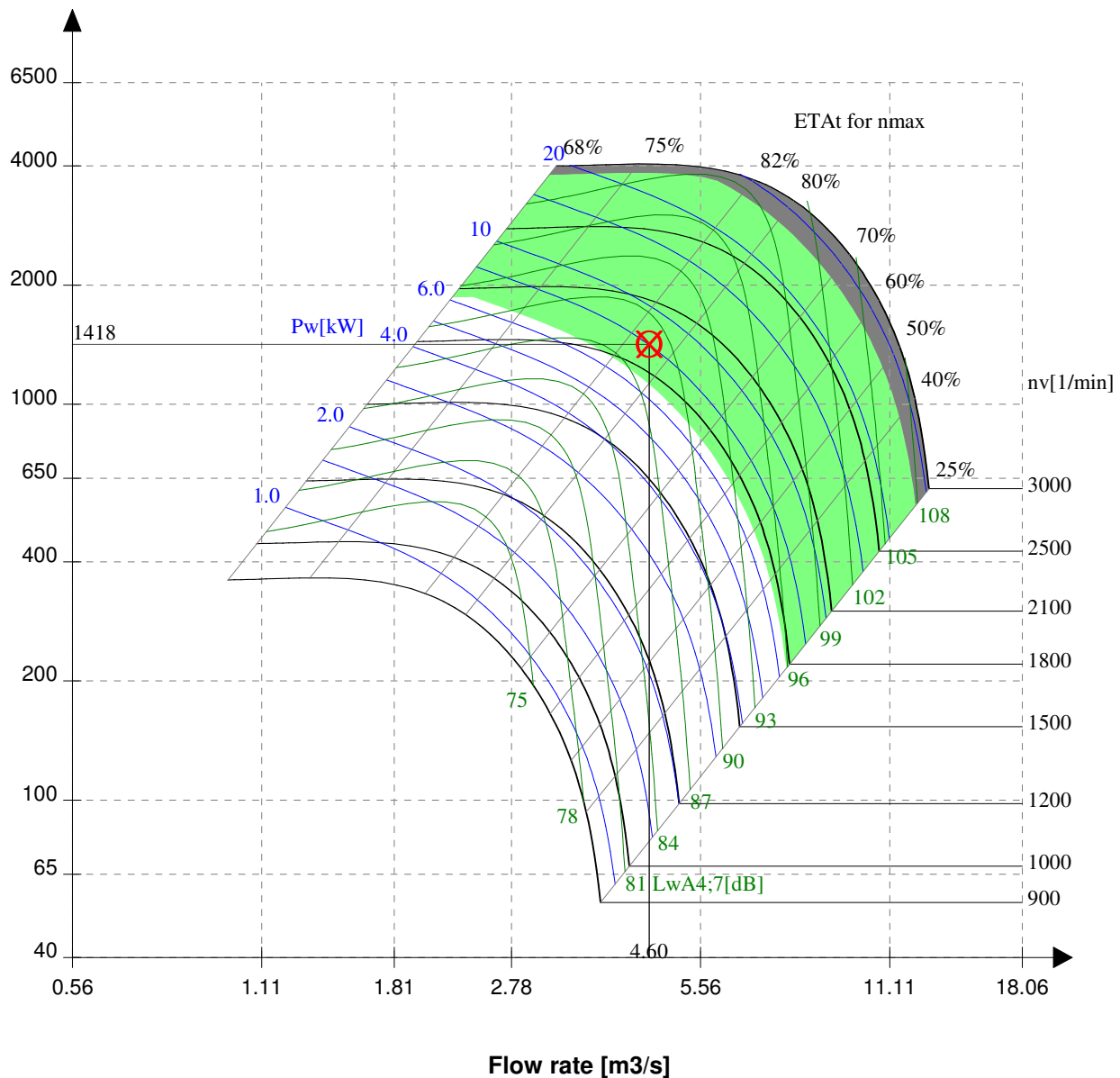

RZR 13-/15-/18-/19-... only
 Do not use in this area

Customer : **MJL**
Reference : **British Museum - WCEC**
Item No : **AHU/05/08 Extract**

Date : **06.06.2012**
Made by : **Jim Picken**
Page : **1**

Technical data

... for fan: RZR 15-0500

Installation acc. to DIN 24 163 part 1	:	B
Flow rate (V)	:	4.60 m ³ /s
Total pressure (dpt)	:	966 Pa
Dyn. pressure (pd2) at discharge	:	78 Pa
Static pressure (dpfa)	:	888 Pa
Pressure losses (pv) at intake	:	78 Pa
Reference density (Rho1)	:	1.20 kg/m ³
Temperature t of the gas (t)	:	20 °C
Speed (n _v)	:	1679 1/min ^{1.)}
Power on shaft (Pw)	:	5.68 kW
Efficiency (ETA _t)	:	78 %
Fan weight	:	94 kg
A-Sound power level LwA _{4,7}	:	87 dB

1.) Fan speed tolerances of ±4% may occur when calculating the belt drive. This may cause technical data being slightly different to the values above.

unweighted	63 Hz	:	90/77 dB ^{2.)}
	125 Hz	:	85/80 dB
Octave sound power level	250 Hz	:	83/79 dB
acc. to discharge/intake	500 Hz	:	84/86 dB
LwOkt _{4,7} at	1000 Hz	:	82/82 dB
Octave band frequency	2000 Hz	:	78/79 dB
	4000 Hz	:	73/74 dB
	8000 Hz	:	64/66 dB

2.) The octave sound power levels can reach unpredictable higher values than calculated in the octave band of the blade passing frequencies.

... for motor: 132M-4

Size	:	132M-4
Speed	:	1455 rpm
Power	:	7,5 kW
Voltage/Frequency	:	400/690/50 V/Hz
Electric current	:	15.2/8.8 A

Customer : **MJL**
Reference : **British Museum - WCEC**
Item No : **AHU/05/08 Extract**

Date : **06.06.2012**
Made by : **Jim Picken**
Page : **2**

Fan curves: RZR 15-0500

Basis:

Reference density (Rho1) : 1.20 kg/m³
Install: B

Total pressure [Pa]

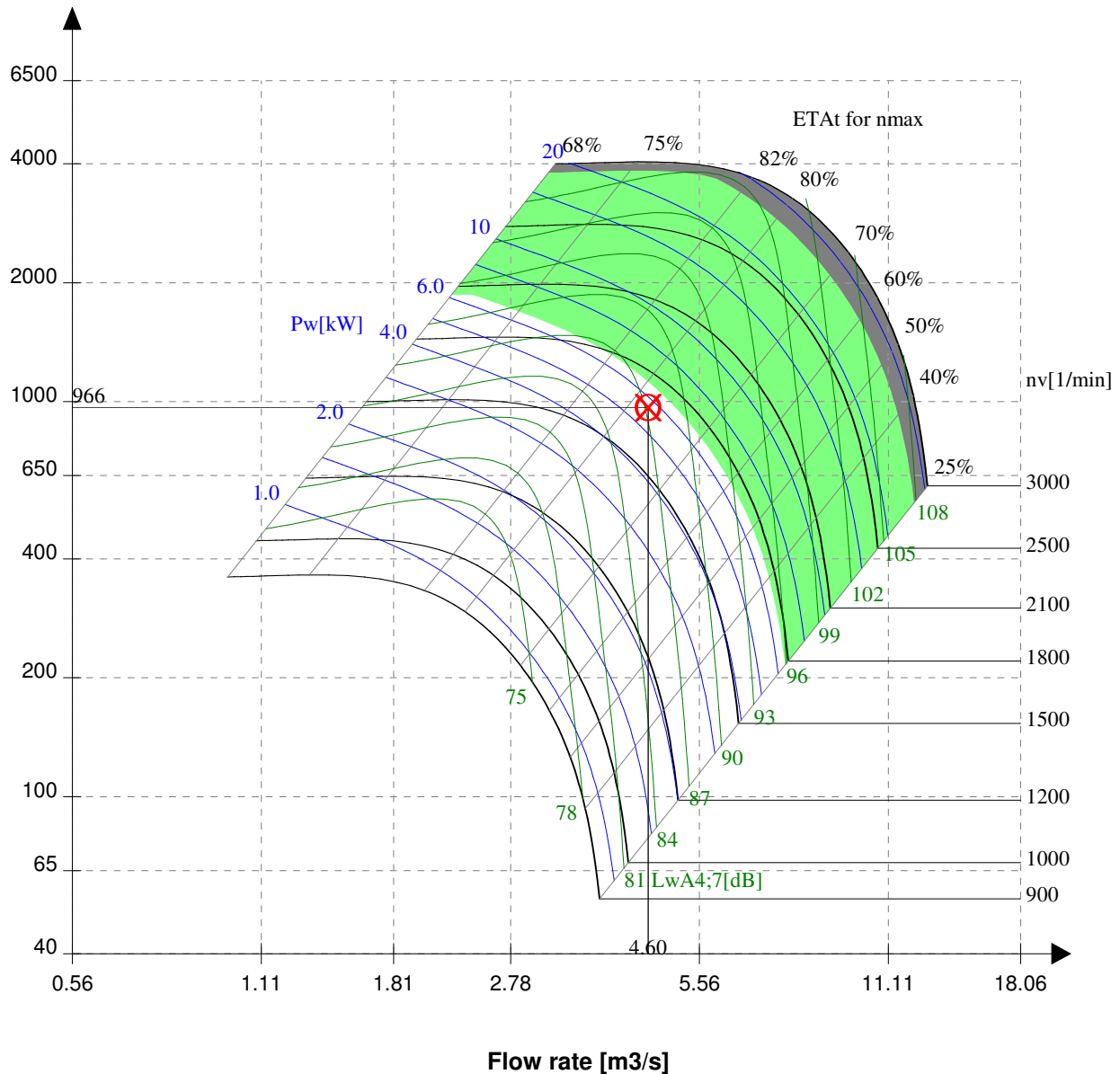

■ RZR 13-/15-/18-/19-... only
■ Do not use in this area

Michael J Lonsdale

**British Museum
World Conservation
Exhibition Centre - London**

**Revision 05 - Technical Submission
Air Handling Equipment**

**Section No 11
AHU Acoustic Analysis**



Dalair Limited (Technical Centre)

Project Reference : British Museum - WCEC

Client : Michael J Lonsdale

Date : Thursday 07th June 2012



Air Handling Unit Acoustic Analysis

AHU Reference : AHU/B2/03 Supply & Extract (Supply Air Volume : 5.50 m3/s & Extract Air Volume 4.00 m3/s)

CASING	Octave Band Centre Frequency								
	Hz	63	125	250	500	1000	2000	4000	8000
RADIATED									
Power Spectrum (Fan + Includes 4dB for mounting fans within AHU section)	SWL	99	93	90	89	86	82	77	69
2 No Fans Running Together Supply & Extract In AHU	dB	3	3	3	3	3	3	3	3
50mm Panel Transmission Loss (Rockwool - 100Kg/m3)	dB	-17	-20	-25	-25	-31	-33	-37	-31
SPL Panel	dB	85	76	68	67	58	52	43	41
Distance @ 1 metre (Corrected to Actual Test Values)	dB	-3	-3	-3	-3	-3	-3	-3	-3
RESULTANT Sound Pressure Level	dB	82	73	65	64	55	49	40	38

ATMOSPHERIC - Supply	Octave Band Centre Frequency								
	Hz	63	125	250	500	1000	2000	4000	8000
INLET - ATTENUATOR DUCT MOUNTED BY OTHERS									
Power Spectrum Inlet (Supply Fan)	SWL	88	87	85	87	82	79	74	67
Mounting Fans Within AHU Section	dB	4	4	4	4	4	4	4	4
AHU Mounted Component Losses	dB	0	0	0	0	0	0	0	0
Regenerated Noise Correction	dB	0	0	0	0	0	0	0	0
Sound Power Level To AHU Fresh Air Inlet	SWL	92	91	89	91	86	83	78	71

ROOMSIDE - Supply	Octave Band Centre Frequency								
	Hz	63	125	250	500	1000	2000	4000	8000
OUTLET - ATTENUATOR DUCT MOUNTED BY OTHERS									
Power Spectrum Outlet (Supply Fan)	SWL	95	89	86	85	82	78	73	65
Mounting Fans Within AHU Section	dB	4	4	4	4	4	4	4	4
Regenerated Noise Correction	dB	0	0	0	0	0	0	0	0
Sound Power Level To AHU Supply Air Outlet	SWL	99	93	90	89	86	82	77	69

ROOMSIDE - Extract	Octave Band Centre Frequency								
	Hz	63	125	250	500	1000	2000	4000	8000
INLET - ATTENUATOR DUCT MOUNTED BY OTHERS									
Power Spectrum Inlet (Extract Fan)	SWL	84	83	81	83	78	75	70	63
Mounting Fans Within AHU Section	dB	4	4	4	4	4	4	4	4
Regenerated Noise Correction	dB	0	0	0	0	0	0	0	0
Sound Power Level To AHU Return Air Inlet	SWL	88	87	85	87	82	79	74	67

ATMOSPHERIC - Extract	Octave Band Centre Frequency								
	Hz	63	125	250	500	1000	2000	4000	8000
OUTLET - ATTENUATOR DUCT MOUNTED BY OTHERS									
Power Spectrum Outlet (Extract Fan)	SWL	91	85	82	81	78	74	69	61
Mounting Fans Within AHU Section	dB	4	4	4	4	4	4	4	4
AHU Mounted Component Losses	dB	0	0	0	0	0	0	0	0
Regenerated Noise Correction	dB	0	0	0	0	0	0	0	0
Sound Power Level To AHU Exhaust Air Outlet	SWL	95	89	86	85	82	78	73	65

Dalair Limited (Technical Centre)

Project Reference : British Museum - WCEC

Client : Michael J Lonsdale

Date : Thursday 07th June 2012



Air Handling Unit Acoustic Analysis

AHU Reference : AHU/B2/04 Supply & Extract (Supply Air Volume : 3.20 m3/s & Extract Air Volume 3.20 m3/s)

CASING	Octave Band Centre Frequency								
	Hz	63	125	250	500	1000	2000	4000	8000
RADIATED									
Power Spectrum (Fan + Includes 4dB for mounting fans within AHU section)	SWL	96	90	87	86	83	79	74	66
2 No Fans Running Together Supply & Extract In AHU	dB	3	3	3	3	3	3	3	3
50mm Panel Transmission Loss (Rockwool - 100Kg/m3)	dB	-17	-20	-25	-25	-31	-33	-37	-31
SPL Panel	dB	82	73	65	64	55	49	40	38
Distance @ 1 metre (Corrected to Actual Test Values)	dB	-3	-3	-3	-3	-3	-3	-3	-3
RESULTANT Sound Pressure Level	dB	79	70	62	61	52	46	37	35

ATMOSPHERIC - Supply	Octave Band Centre Frequency								
	Hz	63	125	250	500	1000	2000	4000	8000
INLET - ATTENUATOR DUCT MOUNTED BY OTHERS									
Power Spectrum Inlet (Supply Fan)	SWL	85	84	82	84	79	76	71	64
Mounting Fans Within AHU Section	dB	4	4	4	4	4	4	4	4
AHU Mounted Component Losses	dB	-5	-4	-5	-6	-8	-11	-14	-16
Regenerated Noise Correction	dB	0	0	0	0	0	0	0	0
Sound Power Level To AHU Fresh Air Inlet	SWL	84	84	81	82	75	69	61	52

ROOMSIDE - Supply	Octave Band Centre Frequency								
	Hz	63	125	250	500	1000	2000	4000	8000
OUTLET - ATTENUATOR DUCT MOUNTED BY OTHERS									
Power Spectrum Outlet (Supply Fan)	SWL	92	86	83	82	79	75	70	62
Mounting Fans Within AHU Section	dB	4	4	4	4	4	4	4	4
Regenerated Noise Correction	dB	0	0	0	0	0	0	0	0
Sound Power Level To AHU Supply Air Outlet	SWL	96	90	87	86	83	79	74	66

ROOMSIDE - Extract	Octave Band Centre Frequency								
	Hz	63	125	250	500	1000	2000	4000	8000
INLET - ATTENUATOR DUCT MOUNTED BY OTHERS									
Power Spectrum Inlet (Extract Fan)	SWL	85	84	82	84	79	76	71	64
Mounting Fans Within AHU Section	dB	4	4	4	4	4	4	4	4
Regenerated Noise Correction	dB	0	0	0	0	0	0	0	0
Sound Power Level To AHU Return Air Inlet	SWL	89	88	86	88	83	80	75	68

ATMOSPHERIC - Extract	Octave Band Centre Frequency								
	Hz	63	125	250	500	1000	2000	4000	8000
OUTLET - ATTENUATOR DUCT MOUNTED BY OTHERS									
Power Spectrum Outlet (Extract Fan)	SWL	92	86	83	82	79	75	70	62
Mounting Fans Within AHU Section	dB	4	4	4	4	4	4	4	4
AHU Mounted Component Losses	dB	-3	-2	-3	-4	-5	-6	-7	-9
Regenerated Noise Correction	dB	0	0	0	0	0	0	0	0
Sound Power Level To AHU Exhaust Air Outlet	SWL	93	88	84	82	78	73	67	57

Dalair Limited (Technical Centre)

Project Reference : British Museum - WCEC

Client : Michael J Lonsdale

Date : Thursday 07th June 2012

**Air Handling Unit Acoustic Analysis**AHU Reference : AHU/B3/01 Supply (Supply Air Volume : 1.60m³/s)

CASING	Octave Band Centre Frequency								
	Hz	63	125	250	500	1000	2000	4000	8000
RADIATED									
Power Spectrum (Fan + Includes 4dB for mounting fans within AHU section)	SWL	97	91	88	87	84	80	75	67
50mm Panel Transmission Loss (Rockwool - 100Kg/m ³)	dB	-17	-20	-25	-25	-31	-33	-37	-31
SPL Panel	dB	80	71	63	62	53	47	38	36
Distance @ 1 metre (Corrected to Actual Test Values)	dB	-3	-3	-3	-3	-3	-3	-3	-3
RESULTANT Sound Pressure Level	dB	77	68	60	59	50	44	35	33

ATMOSPHERIC - Supply	Octave Band Centre Frequency								
	Hz	63	125	250	500	1000	2000	4000	8000
INLET									
Power Spectrum Inlet (Supply Fan)	SWL	86	85	83	85	80	77	72	65
Mounting In AHU	dB	4	4	4	4	4	4	4	4
600mm Atmospheric Attenuator	dB	-7	-11	-19	-24	-33	-30	-23	-18
Sound Power Level To AHU Fresh Air Inlet	SWL	83	78	68	65	51	51	53	51

ROOMSIDE - Supply	Octave Band Centre Frequency								
	Hz	63	125	250	500	1000	2000	4000	8000
DISCHARGE									
Power Spectrum Outlet (Supply Fan)	SWL	93	87	84	83	80	76	71	63
Mounting In AHU	dB	4	4	4	4	4	4	4	4
Sound Power Level To AHU Supply Air Outlet	SWL	97	91	88	87	84	80	75	67

1. The above In duct power spectrum makes no allowance for room acoustics or ductwork losses.

Dalair Limited (Technical Centre)

Project Reference : British Museum - WCEC

Client : Michael J Lonsdale

Date : Thursday 07th June 2012

**Air Handling Unit Acoustic Analysis**AHU Reference : AHU/B3/02 Supply (Supply Air Volume : 1.30m³/s)

CASING	Octave Band Centre Frequency								
	Hz	63	125	250	500	1000	2000	4000	8000
RADIATED									
Power Spectrum (Fan + Includes 4dB for mounting fans within AHU section)	SWL	94	88	85	84	81	77	72	64
50mm Panel Transmission Loss (Rockwool - 100Kg/m ³)	dB	-17	-20	-25	-25	-31	-33	-37	-31
SPL Panel	dB	77	68	60	59	50	44	35	33
Distance @ 1 metre (Corrected to Actual Test Values)	dB	-3	-3	-3	-3	-3	-3	-3	-3
RESULTANT Sound Pressure Level	dB	74	65	57	56	47	41	32	30

ATMOSPHERIC - Supply	Octave Band Centre Frequency								
	Hz	63	125	250	500	1000	2000	4000	8000
INLET									
Power Spectrum Inlet (Supply Fan)	SWL	83	82	80	82	77	74	69	62
Mounting In AHU	dB	4	4	4	4	4	4	4	4
600mm Atmospheric Attenuator	dB	-7	-11	-19	-24	-33	-30	-23	-18
Sound Power Level To AHU Fresh Air Inlet	SWL	80	75	65	62	48	48	50	48

ROOMSIDE - Supply	Octave Band Centre Frequency								
	Hz	63	125	250	500	1000	2000	4000	8000
DISCHARGE									
Power Spectrum Outlet (Supply Fan)	SWL	90	84	81	80	77	73	68	60
Mounting In AHU	dB	4	4	4	4	4	4	4	4
Sound Power Level To AHU Supply Air Outlet	SWL	94	88	85	84	81	77	72	64

1. The above In duct power spectrum makes no allowance for room acoustics or ductwork losses.

Dalair Limited (Technical Centre)

Project Reference : British Museum - WCEC

Client : Michael J Lonsdale

Date : Thursday 07th June 2012

**Air Handling Unit Acoustic Analysis**AHU Reference : AHU/B2/01 Supply (Supply Air Volume : 1.90m³/s)

CASING	Octave Band Centre Frequency								
	Hz	63	125	250	500	1000	2000	4000	8000
RADIATED									
Power Spectrum (Fan + Includes 4dB for mounting fans within AHU section)	SWL	96	91	89	90	88	84	79	70
50mm Panel Transmission Loss (Rockwool - 100Kg/m ³)	dB	-17	-20	-25	-25	-31	-33	-37	-31
SPL Panel	dB	79	71	64	65	57	51	42	39
Distance @ 1 metre (Corrected to Actual Test Values)	dB	-3	-3	-3	-3	-3	-3	-3	-3
RESULTANT Sound Pressure Level	dB	76	68	61	62	54	48	39	36

ATMOSPHERIC - Supply	Octave Band Centre Frequency								
	Hz	63	125	250	500	1000	2000	4000	8000
INLET									
Power Spectrum Inlet (Supply Fan)	SWL	86	85	85	88	84	81	76	68
Mounting In AHU	dB	4	4	4	4	4	4	4	4
600mm Atmospheric Attenuator	dB	-7	-11	-19	-24	-33	-30	-23	-18
Sound Power Level To AHU Fresh Air Inlet	SWL	83	78	70	68	55	55	57	54

ROOMSIDE - Supply	Octave Band Centre Frequency								
	Hz	63	125	250	500	1000	2000	4000	8000
DISCHARGE									
Power Spectrum Outlet (Supply Fan)	SWL	92	87	85	86	84	80	75	66
Mounting In AHU	dB	4	4	4	4	4	4	4	4
Sound Power Level To AHU Supply Air Outlet	SWL	96	91	89	90	88	84	79	70

1. The above In duct power spectrum makes no allowance for room acoustics or ductwork losses.

Air Handling Unit Acoustic Analysis

AHU Reference : AHU/B2/02 Supply (Supply Air Volume : 1.70m³/s)

CASING	Octave Band Centre Frequency								
	Hz	63	125	250	500	1000	2000	4000	8000
RADIATED									
Power Spectrum (Fan + Includes 4dB for mounting fans within AHU section)	SWL	98	92	89	88	85	81	76	68
50mm Panel Transmission Loss (Rockwool - 100Kg/m ³)	dB	-17	-20	-25	-25	-31	-33	-37	-31
SPL Panel	dB	81	72	64	63	54	48	39	37
Distance @ 1 metre (Corrected to Actual Test Values)	dB	-3	-3	-3	-3	-3	-3	-3	-3
RESULTANT Sound Pressure Level	dB	78	69	61	60	51	45	36	34

ATMOSPHERIC - Supply	Octave Band Centre Frequency								
	Hz	63	125	250	500	1000	2000	4000	8000
INLET									
Power Spectrum Inlet (Supply Fan)	SWL	87	86	84	86	81	78	73	66
Mounting In AHU	dB	4	4	4	4	4	4	4	4
600mm Atmospheric Attenuator	dB	-7	-11	-19	-24	-33	-30	-23	-18
Sound Power Level To AHU Fresh Air Inlet	SWL	84	79	69	66	52	52	54	52

ROOMSIDE - Supply	Octave Band Centre Frequency								
	Hz	63	125	250	500	1000	2000	4000	8000
DISCHARGE									
Power Spectrum Outlet (Supply Fan)	SWL	94	88	85	84	81	77	72	64
Mounting In AHU	dB	4	4	4	4	4	4	4	4
Sound Power Level To AHU Supply Air Outlet	SWL	98	92	89	88	85	81	76	68

1. The above In duct power spectrum makes no allowance for room acoustics or ductwork losses.

Air Handling Unit Acoustic Analysis

AHU Reference : AHU/B1/01 Supply (Supply Air Volume : 1.90m³/s)

CASING	Octave Band Centre Frequency								
	Hz	63	125	250	500	1000	2000	4000	8000
RADIATED									
Power Spectrum (Fan + Includes 4dB for mounting fans within AHU section)	SWL	96	91	89	90	88	84	79	70
50mm Panel Transmission Loss (Rockwool - 100Kg/m ³)	dB	-17	-20	-25	-25	-31	-33	-37	-31
SPL Panel	dB	79	71	64	65	57	51	42	39
Distance @ 1 metre (Corrected to Actual Test Values)	dB	-3	-3	-3	-3	-3	-3	-3	-3
RESULTANT Sound Pressure Level	dB	76	68	61	62	54	48	39	36

ATMOSPHERIC - Supply	Octave Band Centre Frequency								
	Hz	63	125	250	500	1000	2000	4000	8000
INLET									
Power Spectrum Inlet (Supply Fan)	SWL	86	85	85	88	84	81	76	68
Mounting In AHU	dB	4	4	4	4	4	4	4	4
600mm Atmospheric Attenuator	dB	-7	-11	-19	-24	-33	-30	-23	-18
Sound Power Level To AHU Fresh Air Inlet	SWL	83	78	70	68	55	55	57	54

Dalair Limited (Technical Centre)

Project Reference : British Museum - WCEC

Client : Michael J Lonsdale

Date : Thursday 07th June 2012

**Air Handling Unit Acoustic Analysis**AHU Reference : AHU/B1/02 Supply (Supply Air Volume : 1.60m³/s)

CASING	Octave Band Centre Frequency								
	Hz	63	125	250	500	1000	2000	4000	8000
RADIATED									
Power Spectrum (Fan + Includes 4dB for mounting fans within AHU section)	SWL	97	91	88	87	84	80	75	67
50mm Panel Transmission Loss (Rockwool - 100Kg/m ³)	dB	-17	-20	-25	-25	-31	-33	-37	-31
SPL Panel	dB	80	71	63	62	53	47	38	36
Distance @ 1 metre (Corrected to Actual Test Values)	dB	-3	-3	-3	-3	-3	-3	-3	-3
RESULTANT Sound Pressure Level	dB	77	68	60	59	50	44	35	33

ATMOSPHERIC - Supply	Octave Band Centre Frequency								
	Hz	63	125	250	500	1000	2000	4000	8000
INLET									
Power Spectrum Inlet (Supply Fan)	SWL	86	85	83	85	80	77	72	65
Mounting In AHU	dB	4	4	4	4	4	4	4	4
600mm Atmospheric Attenuator	dB	-7	-11	-19	-24	-33	-30	-23	-18
Sound Power Level To AHU Fresh Air Inlet	SWL	83	78	68	65	51	51	53	51

ROOMSIDE - Supply	Octave Band Centre Frequency								
	Hz	63	125	250	500	1000	2000	4000	8000
DISCHARGE									
Power Spectrum Outlet (Supply Fan)	SWL	93	87	84	83	80	76	71	63
Mounting In AHU	dB	4	4	4	4	4	4	4	4
Sound Power Level To AHU Supply Air Outlet	SWL	97	91	88	87	84	80	75	67

1. The above In duct power spectrum makes no allowance for room acoustics or ductwork losses.

Air Handling Unit Acoustic Analysis

AHU Reference : AHU/00/01 Supply & Extract (Supply Air Volume : 1.50 m3/s & Extract Air Volume 1.5 m3/s)

CASING	Octave Band Centre Frequency								
	Hz	63	125	250	500	1000	2000	4000	8000
RADIATED									
Power Spectrum (Fan + Includes 4dB for mounting fans within AHU section)	SWL	99	93	90	89	86	82	77	69
2 No Fans Running Together Supply & Extract In AHU	dB	3	3	3	3	3	3	3	3
50mm Panel Transmission Loss (Rockwool - 100Kg/m3)	dB	-17	-20	-25	-25	-31	-33	-37	-31
SPL Panel	dB	85	76	68	67	58	52	43	41
Distance @ 1 metre (Corrected to Actual Test Values)	dB	-3	-3	-3	-3	-3	-3	-3	-3
RESULTANT Sound Pressure Level	dB	82	73	65	64	55	49	40	38

ATMOSPHERIC - Supply	Octave Band Centre Frequency								
	Hz	63	125	250	500	1000	2000	4000	8000
INLET - ATTENUATOR									
Power Spectrum Inlet (Supply Fan)	SWL	88	87	85	87	82	79	74	67
Mounting Fans Within AHU Section	dB	4	4	4	4	4	4	4	4
600mm Atmospheric Attenuator	dB	-5	-8	-16	-21	-28	-25	-19	-15
Regenerated Noise Correction	dB	0	0	0	0	1	2	1	0
Sound Power Level To AHU Fresh Air Inlet	SWL	87	83	73	70	59	60	60	56

ROOMSIDE - Supply	Octave Band Centre Frequency								
	Hz	63	125	250	500	1000	2000	4000	8000
OUTLET - ATTENUATOR									
Power Spectrum Outlet (Supply Fan)	SWL	95	89	86	85	82	78	73	65
Mounting Fans Within AHU Section	dB	4	4	4	4	4	4	4	4
900mm Roomside Attenuator	dB	-9	-15	-26	-31	-44	-46	-34	-22
Regenerated Noise Correction	dB	0	0	0	0	2	5	0	0
Sound Power Level To AHU Supply Air Outlet	SWL	90	78	64	58	44	41	43	47

ROOMSIDE - Extract	Octave Band Centre Frequency								
	Hz	63	125	250	500	1000	2000	4000	8000
INLET - ATTENUATOR									
Power Spectrum Inlet (Extract Fan)	SWL	85	84	82	84	79	76	71	64
Mounting Fans Within AHU Section	dB	4	4	4	4	4	4	4	4
900mm Roomside Attenuator	dB	-9	-15	-26	-31	-44	-46	-34	-22
Regenerated Noise Correction	dB	0	0	0	0	7	12	2	0
Sound Power Level To AHU Return Air Inlet	SWL	80	73	60	57	46	46	43	46

ATMOSPHERIC - Extract	Octave Band Centre Frequency								
	Hz	63	125	250	500	1000	2000	4000	8000
OUTLET - ATTENUATOR									
Power Spectrum Outlet (Extract Fan)	SWL	92	86	83	82	79	75	70	62
Mounting Fans Within AHU Section	dB	4	4	4	4	4	4	4	4
600mm Atmospheric Attenuator	dB	-5	-8	-16	-21	-28	-25	-19	-15
Regenerated Noise Correction	dB	0	0	0	0	0	0	0	0
Sound Power Level To AHU Exhaust Air Outlet	SWL	91	82	71	65	55	54	55	51

Dalair Limited (Technical Centre)

Project Reference : British Museum - WCEC

Client : Michael J Lonsdale

Date : Thursday 07th June 2012



Air Handling Unit Acoustic Analysis

AHU Reference : AHU/01/01 Supply & Extract (Supply Air Volume : 0.50 m3/s & Extract Air Volume 0.50 m3/s)

CASING	Octave Band Centre Frequency								
	Hz	63	125	250	500	1000	2000	4000	8000
RADIATED									
Power Spectrum (Fan + Includes 4dB for mounting fans within AHU section)	SWL	88	86	82	80	74	70	63	52
2 No Fans Running Together Supply & Extract In AHU	dB	3	3	3	3	3	3	3	3
50mm Panel Transmission Loss (Rockwool - 100Kg/m3)	dB	-17	-20	-25	-25	-31	-33	-37	-31
SPL Panel	dB	74	69	60	58	46	40	29	24
Distance @ 1 metre (Corrected to Actual Test Values)	dB	-3	-3	-3	-3	-3	-3	-3	-3
RESULTANT Sound Pressure Level	dB	71	66	57	55	43	37	26	21

ATMOSPHERIC - Supply	Octave Band Centre Frequency								
	Hz	63	125	250	500	1000	2000	4000	8000
INLET - ATTENUATOR DUCT MOUNTED BY OTHERS									
Power Spectrum Inlet (Supply Fan)	SWL	77	80	77	75	72	68	63	55
Mounting Fans Within AHU Section	dB	4	4	4	4	4	4	4	4
AHU Mounted Component Losses	dB	-5	-4	-5	-6	-8	-11	-14	-16
Regenerated Noise Correction	dB	0	0	0	0	0	0	0	0
Sound Power Level To AHU Fresh Air Inlet	SWL	76	80	76	73	68	61	53	43

ROOMSIDE - Supply	Octave Band Centre Frequency								
	Hz	63	125	250	500	1000	2000	4000	8000
OUTLET - ATTENUATOR DUCT MOUNTED BY OTHERS									
Power Spectrum Outlet (Supply Fan)	SWL	84	82	78	76	70	66	59	48
Mounting Fans Within AHU Section	dB	4	4	4	4	4	4	4	4
Regenerated Noise Correction	dB	0	0	0	0	0	0	0	0
Sound Power Level To AHU Supply Air Outlet	SWL	88	86	82	80	74	70	63	52

ROOMSIDE - Extract	Octave Band Centre Frequency								
	Hz	63	125	250	500	1000	2000	4000	8000
INLET - ATTENUATOR DUCT MOUNTED BY OTHERS									
Power Spectrum Inlet (Extract Fan)	SWL	78	81	78	76	73	69	64	56
Mounting Fans Within AHU Section	dB	4	4	4	4	4	4	4	4
Regenerated Noise Correction	dB	0	0	0	0	0	0	0	0
Sound Power Level To AHU Return Air Inlet	SWL	82	85	82	80	77	73	68	60

ATMOSPHERIC - Extract	Octave Band Centre Frequency								
	Hz	63	125	250	500	1000	2000	4000	8000
OUTLET - ATTENUATOR DUCT MOUNTED BY OTHERS									
Power Spectrum Outlet (Extract Fan)	SWL	85	83	79	77	71	67	60	49
Mounting Fans Within AHU Section	dB	4	4	4	4	4	4	4	4
AHU Mounted Component Losses	dB	-3	-2	-3	-4	-5	-6	-7	-9
Regenerated Noise Correction	dB	0	0	0	0	0	0	0	0
Sound Power Level To AHU Exhaust Air Outlet	SWL	86	85	80	77	70	65	57	44

Dalair Limited (Technical Centre)

Project Reference : British Museum - WCEC

Client : Michael J Lonsdale

Date : Thursday 07th June 2012



Air Handling Unit Acoustic Analysis

AHU Reference : AHU/01/02 Supply & Extract (Supply Air Volume : 0.60 m3/s & Extract Air Volume 0.60 m3/s)

CASING	Octave Band Centre Frequency								
	Hz	63	125	250	500	1000	2000	4000	8000
RADIATED									
Power Spectrum (Fan + Includes 4dB for mounting fans within AHU section)	SWL	90	88	84	82	76	72	65	54
2 No Fans Running Together Supply & Extract In AHU	dB	3	3	3	3	3	3	3	3
50mm Panel Transmission Loss (Rockwool - 100Kg/m3)	dB	-17	-20	-25	-25	-31	-33	-37	-31
SPL Panel	dB	76	71	62	60	48	42	31	26
Distance @ 1 metre (Corrected to Actual Test Values)	dB	-3	-3	-3	-3	-3	-3	-3	-3
RESULTANT Sound Pressure Level	dB	73	68	59	57	45	39	28	23

ATMOSPHERIC - Supply	Octave Band Centre Frequency								
	Hz	63	125	250	500	1000	2000	4000	8000
INLET - ATTENUATOR DUCT MOUNTED BY OTHERS									
Power Spectrum Inlet (Supply Fan)	SWL	79	82	79	77	74	70	65	57
Mounting Fans Within AHU Section	dB	4	4	4	4	4	4	4	4
AHU Mounted Component Losses	dB	-5	-4	-5	-6	-8	-11	-14	-16
Regenerated Noise Correction	dB	0	0	0	0	0	0	0	0
Sound Power Level To AHU Fresh Air Inlet	SWL	78	82	78	75	70	63	55	45

ROOMSIDE - Supply	Octave Band Centre Frequency								
	Hz	63	125	250	500	1000	2000	4000	8000
OUTLET - ATTENUATOR DUCT MOUNTED BY OTHERS									
Power Spectrum Outlet (Supply Fan)	SWL	86	84	80	78	72	68	61	50
Mounting Fans Within AHU Section	dB	4	4	4	4	4	4	4	4
Regenerated Noise Correction	dB	0	0	0	0	0	0	0	0
Sound Power Level To AHU Supply Air Outlet	SWL	90	88	84	82	76	72	65	54

ROOMSIDE - Extract	Octave Band Centre Frequency								
	Hz	63	125	250	500	1000	2000	4000	8000
INLET - ATTENUATOR DUCT MOUNTED BY OTHERS									
Power Spectrum Inlet (Extract Fan)	SWL	80	83	80	78	75	71	66	58
Mounting Fans Within AHU Section	dB	4	4	4	4	4	4	4	4
Regenerated Noise Correction	dB	0	0	0	0	0	0	0	0
Sound Power Level To AHU Return Air Inlet	SWL	84	87	84	82	79	75	70	62

ATMOSPHERIC - Extract	Octave Band Centre Frequency								
	Hz	63	125	250	500	1000	2000	4000	8000
OUTLET - ATTENUATOR DUCT MOUNTED BY OTHERS									
Power Spectrum Outlet (Extract Fan)	SWL	87	85	81	79	73	69	62	51
Mounting Fans Within AHU Section	dB	4	4	4	4	4	4	4	4
AHU Mounted Component Losses	dB	-3	-2	-3	-4	-5	-6	-7	-9
Regenerated Noise Correction	dB	0	0	0	0	0	0	0	0
Sound Power Level To AHU Exhaust Air Outlet	SWL	88	87	82	79	72	67	59	46

Dalair Limited (Technical Centre)

Project Reference : British Museum - WCEC

Client : Michael J Lonsdale

Date : Thursday 07th June 2012

**Air Handling Unit Acoustic Analysis**

AHU Reference : AHU/02/01 Supply (Supply Air Volume : 1.80m³/s)

CASING	Octave Band Centre Frequency								
	Hz	63	125	250	500	1000	2000	4000	8000
RADIATED									
Power Spectrum (Fan + Includes 4dB for mounting fans within AHU section)	SWL	95	90	88	89	87	83	78	69
50mm Panel Transmission Loss (Rockwool - 100Kg/m3)	dB	-17	-20	-25	-25	-31	-33	-37	-31
SPL Panel	dB	78	70	63	64	56	50	41	38
Distance @ 1 metre (Corrected to Actual Test Values)	dB	-3	-3	-3	-3	-3	-3	-3	-3
RESULTANT Sound Pressure Level	dB	75	67	60	61	53	47	38	35

ATMOSPHERIC - Supply	Octave Band Centre Frequency								
	Hz	63	125	250	500	1000	2000	4000	8000
INLET									
Power Spectrum Inlet (Supply Fan)	SWL	85	84	82	87	83	80	75	67
Mounting In AHU	dB	4	4	4	4	4	4	4	4
600mm Atmospheric Attenuator	dB	-7	-11	-19	-24	-33	-30	-23	-18
Sound Power Level To AHU Fresh Air Inlet	SWL	82	77	67	67	54	54	56	53

ROOMSIDE - Supply	Octave Band Centre Frequency								
	Hz	63	125	250	500	1000	2000	4000	8000
DISCHARGE									
Power Spectrum Outlet (Supply Fan)	SWL	91	86	84	85	83	79	74	65
Mounting In AHU	dB	4	4	4	4	4	4	4	4
Sound Power Level To AHU Supply Air Outlet	SWL	95	90	88	89	87	83	78	69

1. The above In duct power spectrum makes no allowance for room acoustics or ductwork losses.

Dalair Limited (Technical Centre)

Project Reference : British Museum - WCEC

Client : Michael J Lonsdale

Date : Thursday 07th June 2012



Air Handling Unit Acoustic Analysis

AHU Reference : AHU/05/01 Supply & Extract (Supply Air Volume : 5.20 m3/s & Extract Air Volume 5.20 m3/s)

CASING	Octave Band Centre Frequency								
	Hz	63	125	250	500	1000	2000	4000	8000
RADIATED									
Power Spectrum (Fan + Includes 4dB for mounting fans within AHU section)	SWL	101	95	92	91	88	84	79	71
2 No Fans Running Together Supply & Extract In AHU	dB	3	3	3	3	3	3	3	3
50mm Panel Transmission Loss (Rockwool - 100Kg/m3)	dB	-17	-20	-25	-25	-31	-33	-37	-31
SPL Panel	dB	87	78	70	69	60	54	45	43
Distance @ 1 metre (Corrected to Actual Test Values)	dB	-3	-3	-3	-3	-3	-3	-3	-3
RESULTANT Sound Pressure Level	dB	84	75	67	66	57	51	42	40

ATMOSPHERIC - Supply	Octave Band Centre Frequency								
	Hz	63	125	250	500	1000	2000	4000	8000
INLET - ATTENUATOR DUCT MOUNTED BY OTHERS									
Power Spectrum Inlet (Supply Fan)	SWL	90	89	87	89	84	81	76	69
Mounting Fans Within AHU Section	dB	4	4	4	4	4	4	4	4
AHU Mounted Component Losses	dB	-5	-4	-5	-6	-8	-11	-14	-16
Regenerated Noise Correction	dB	0	0	0	0	0	0	0	0
Sound Power Level To AHU Fresh Air Inlet	SWL	89	89	86	87	80	74	66	57

ROOMSIDE - Supply	Octave Band Centre Frequency								
	Hz	63	125	250	500	1000	2000	4000	8000
OUTLET - ATTENUATOR DUCT MOUNTED BY OTHERS									
Power Spectrum Outlet (Supply Fan)	SWL	97	91	88	87	84	80	75	67
Mounting Fans Within AHU Section	dB	4	4	4	4	4	4	4	4
Regenerated Noise Correction	dB	0	0	0	0	0	0	0	0
Sound Power Level To AHU Supply Air Outlet	SWL	101	95	92	91	88	84	79	71

ROOMSIDE - Extract	Octave Band Centre Frequency								
	Hz	63	125	250	500	1000	2000	4000	8000
INLET - ATTENUATOR DUCT MOUNTED BY OTHERS									
Power Spectrum Inlet (Extract Fan)	SWL	87	86	84	89	85	82	77	69
Mounting Fans Within AHU Section	dB	4	4	4	4	4	4	4	4
Regenerated Noise Correction	dB	0	0	0	0	0	0	0	0
Sound Power Level To AHU Return Air Inlet	SWL	91	90	88	93	89	86	81	73

ATMOSPHERIC - Extract	Octave Band Centre Frequency								
	Hz	63	125	250	500	1000	2000	4000	8000
OUTLET - ATTENUATOR DUCT MOUNTED BY OTHERS									
Power Spectrum Outlet (Extract Fan)	SWL	93	88	86	87	85	81	76	67
Mounting Fans Within AHU Section	dB	4	4	4	4	4	4	4	4
AHU Mounted Component Losses	dB	-3	-2	-3	-4	-5	-6	-7	-9
Regenerated Noise Correction	dB	0	0	0	0	0	0	0	0
Sound Power Level To AHU Exhaust Air Outlet	SWL	94	90	87	87	84	79	73	62

Dalair Limited (Technical Centre)

Project Reference : British Museum - WCEC

Client : Michael J Lonsdale

Date : Thursday 07th June 2012



Air Handling Unit Acoustic Analysis

AHU Reference : AHU/05/02 Supply & Extract (Supply Air Volume : 3.10 m3/s & Extract Air Volume 3.10 m3/s)

CASING	Octave Band Centre Frequency								
	Hz	63	125	250	500	1000	2000	4000	8000
RADIATED									
Power Spectrum (Fan + Includes 4dB for mounting fans within AHU section)	SWL	101	95	92	91	88	84	79	71
2 No Fans Running Together Supply & Extract In AHU	dB	3	3	3	3	3	3	3	3
50mm Panel Transmission Loss (Rockwool - 100Kg/m3)	dB	-17	-20	-25	-25	-31	-33	-37	-31
SPL Panel	dB	87	78	70	69	60	54	45	43
Distance @ 1 metre (Corrected to Actual Test Values)	dB	-3	-3	-3	-3	-3	-3	-3	-3
RESULTANT Sound Pressure Level	dB	84	75	67	66	57	51	42	40

ATMOSPHERIC - Supply	Octave Band Centre Frequency								
	Hz	63	125	250	500	1000	2000	4000	8000
INLET - ATTENUATOR DUCT MOUNTED BY OTHERS									
Power Spectrum Inlet (Supply Fan)	SWL	90	89	87	89	84	81	76	69
Mounting Fans Within AHU Section	dB	4	4	4	4	4	4	4	4
AHU Mounted Component Losses	dB	-5	-4	-5	-6	-8	-11	-14	-16
Regenerated Noise Correction	dB	0	0	0	0	0	0	0	0
Sound Power Level To AHU Fresh Air Inlet	SWL	89	89	86	87	80	74	66	57

ROOMSIDE - Supply	Octave Band Centre Frequency								
	Hz	63	125	250	500	1000	2000	4000	8000
OUTLET - ATTENUATOR DUCT MOUNTED BY OTHERS									
Power Spectrum Outlet (Supply Fan)	SWL	97	91	88	87	84	80	75	67
Mounting Fans Within AHU Section	dB	4	4	4	4	4	4	4	4
Regenerated Noise Correction	dB	0	0	0	0	0	0	0	0
Sound Power Level To AHU Supply Air Outlet	SWL	101	95	92	91	88	84	79	71

ROOMSIDE - Extract	Octave Band Centre Frequency								
	Hz	63	125	250	500	1000	2000	4000	8000
INLET - ATTENUATOR DUCT MOUNTED BY OTHERS									
Power Spectrum Inlet (Extract Fan)	SWL	86	85	83	88	84	81	76	68
Mounting Fans Within AHU Section	dB	4	4	4	4	4	4	4	4
Regenerated Noise Correction	dB	0	0	0	0	0	0	0	0
Sound Power Level To AHU Return Air Inlet	SWL	90	89	87	92	88	85	80	72

ATMOSPHERIC- Extract	Octave Band Centre Frequency								
	Hz	63	125	250	500	1000	2000	4000	8000
OUTLET - ATTENUATOR DUCT MOUNTED BY OTHERS									
Power Spectrum Outlet (Extract Fan)	SWL	92	87	85	86	84	80	75	66
Mounting Fans Within AHU Section	dB	4	4	4	4	4	4	4	4
AHU Mounted Component Losses	dB	-3	-2	-3	-4	-5	-6	-7	-9
Regenerated Noise Correction	dB	0	0	0	0	0	0	0	0
Sound Power Level To AHU Exhaust Air Outlet	SWL	93	89	86	86	83	78	72	61

Air Handling Unit Acoustic Analysis

AHU Reference : AHU/05/03 Supply & Extract (Supply Air Volume : 4.20 m3/s & Extract Air Volume 4.20 m3/s)

CASING	Octave Band Centre Frequency								
	Hz	63	125	250	500	1000	2000	4000	8000
RADIATED									
Power Spectrum (Fan + Includes 4dB for mounting fans within AHU section)	SWL	98	92	89	88	85	81	76	68
2 No Fans Running Together Supply & Extract In AHU	dB	3	3	3	3	3	3	3	3
50mm Panel Transmission Loss (Rockwool - 100Kg/m3)	dB	-17	-20	-25	-25	-31	-33	-37	-31
SPL Panel	dB	84	75	67	66	57	51	42	40
Distance @ 1 metre (Corrected to Actual Test Values)	dB	-3	-3	-3	-3	-3	-3	-3	-3
RESULTANT Sound Pressure Level	dB	81	72	64	63	54	48	39	37

ATMOSPHERIC - Supply	Octave Band Centre Frequency								
	Hz	63	125	250	500	1000	2000	4000	8000
INLET - ATTENUATOR DUCT MOUNTED BY OTHERS									
Power Spectrum Inlet (Supply Fan)	SWL	87	86	84	86	81	78	73	66
Mounting Fans Within AHU Section	dB	4	4	4	4	4	4	4	4
AHU Mounted Component Losses	dB	-5	-4	-5	-6	-8	-11	-14	-16
Regenerated Noise Correction	dB	0	0	0	0	0	0	0	0
Sound Power Level To AHU Fresh Air Inlet	SWL	86	86	83	84	77	71	63	54

ROOMSIDE - Supply	Octave Band Centre Frequency								
	Hz	63	125	250	500	1000	2000	4000	8000
OUTLET - ATTENUATOR DUCT MOUNTED BY OTHERS									
Power Spectrum Outlet (Supply Fan)	SWL	94	88	85	84	81	77	72	64
Mounting Fans Within AHU Section	dB	4	4	4	4	4	4	4	4
Regenerated Noise Correction	dB	0	0	0	0	0	0	0	0
Sound Power Level To AHU Supply Air Outlet	SWL	98	92	89	88	85	81	76	68

ROOMSIDE - Extract	Octave Band Centre Frequency								
	Hz	63	125	250	500	1000	2000	4000	8000
INLET - ATTENUATOR DUCT MOUNTED BY OTHERS									
Power Spectrum Inlet (Extract Fan)	SWL	86	85	83	85	80	77	72	65
Mounting Fans Within AHU Section	dB	4	4	4	4	4	4	4	4
Regenerated Noise Correction	dB	0	0	0	0	0	0	0	0
Sound Power Level To AHU Return Air Inlet	SWL	90	89	87	89	84	81	76	69

ATMOSPHERIC - Extract	Octave Band Centre Frequency								
	Hz	63	125	250	500	1000	2000	4000	8000
OUTLET - ATTENUATOR DUCT MOUNTED BY OTHERS									
Power Spectrum Outlet (Extract Fan)	SWL	93	87	84	83	80	76	71	63
Mounting Fans Within AHU Section	dB	4	4	4	4	4	4	4	4
AHU Mounted Component Losses	dB	-3	-2	-3	-4	-5	-6	-7	-9
Regenerated Noise Correction	dB	0	0	0	0	0	0	0	0
Sound Power Level To AHU Exhaust Air Outlet	SWL	94	89	85	83	79	74	68	58

Dalair Limited (Technical Centre)

Project Reference : British Museum - WCEC

Client : Michael J Lonsdale

Date : Thursday 07th June 2012



Air Handling Unit Acoustic Analysis

AHU Reference : AHU/05/04 Supply & Extract (Supply Air Volume : 3.80 m3/s & Extract Air Volume 3.80 m3/s)

CASING	Octave Band Centre Frequency								
	Hz	63	125	250	500	1000	2000	4000	8000
RADIATED									
Power Spectrum (Fan + Includes 4dB for mounting fans within AHU section)	SWL	98	92	89	88	85	81	76	68
2 No Fans Running Together Supply & Extract In AHU	dB	3	3	3	3	3	3	3	3
50mm Panel Transmission Loss (Rockwool - 100Kg/m3)	dB	-17	-20	-25	-25	-31	-33	-37	-31
SPL Panel	dB	84	75	67	66	57	51	42	40
Distance @ 1 metre (Corrected to Actual Test Values)	dB	-3	-3	-3	-3	-3	-3	-3	-3
RESULTANT Sound Pressure Level	dB	81	72	64	63	54	48	39	37

ATMOSPHERIC - Supply	Octave Band Centre Frequency								
	Hz	63	125	250	500	1000	2000	4000	8000
INLET - ATTENUATOR DUCT MOUNTED BY OTHERS									
Power Spectrum Inlet (Supply Fan)	SWL	87	86	84	86	81	78	73	66
Mounting Fans Within AHU Section	dB	4	4	4	4	4	4	4	4
AHU Mounted Component Losses	dB	-5	-4	-5	-6	-8	-11	-14	-16
Regenerated Noise Correction	dB	0	0	0	0	0	0	0	0
Sound Power Level To AHU Fresh Air Inlet	SWL	86	86	83	84	77	71	63	54

ROOMSIDE - Supply	Octave Band Centre Frequency								
	Hz	63	125	250	500	1000	2000	4000	8000
OUTLET - ATTENUATOR DUCT MOUNTED BY OTHERS									
Power Spectrum Outlet (Supply Fan)	SWL	94	88	85	84	81	77	72	64
Mounting Fans Within AHU Section	dB	4	4	4	4	4	4	4	4
Regenerated Noise Correction	dB	0	0	0	0	0	0	0	0
Sound Power Level To AHU Supply Air Outlet	SWL	98	92	89	88	85	81	76	68

ROOMSIDE - Extract	Octave Band Centre Frequency								
	Hz	63	125	250	500	1000	2000	4000	8000
INLET - ATTENUATOR DUCT MOUNTED BY OTHERS									
Power Spectrum Inlet (Extract Fan)	SWL	84	83	81	83	78	75	70	63
Mounting Fans Within AHU Section	dB	4	4	4	4	4	4	4	4
Regenerated Noise Correction	dB	0	0	0	0	0	0	0	0
Sound Power Level To AHU Return Air Inlet	SWL	88	87	85	87	82	79	74	67

ATMOSPHERIC - Extract	Octave Band Centre Frequency								
	Hz	63	125	250	500	1000	2000	4000	8000
OUTLET - ATTENUATOR DUCT MOUNTED BY OTHERS									
Power Spectrum Outlet (Extract Fan)	SWL	91	85	82	81	78	74	69	61
Mounting Fans Within AHU Section	dB	4	4	4	4	4	4	4	4
AHU Mounted Component Losses	dB	-3	-2	-3	-4	-5	-6	-7	-9
Regenerated Noise Correction	dB	0	0	0	0	0	0	0	0
Sound Power Level To AHU Exhaust Air Outlet	SWL	92	87	83	81	77	72	66	56

Dalair Limited (Technical Centre)

Project Reference : British Museum - WCEC

Client : Michael J Lonsdale

Date : Thursday 07th June 2012



Air Handling Unit Acoustic Analysis

AHU Reference : AHU/05/05 Supply & Extract (Supply Air Volume : 3.85 m3/s & Extract Air Volume 3.85 m3/s)

CASING	Octave Band Centre Frequency								
	Hz	63	125	250	500	1000	2000	4000	8000
RADIATED									
Power Spectrum (Fan + Includes 4dB for mounting fans within AHU section)	SWL	98	92	89	88	85	81	76	68
2 No Fans Running Together Supply & Extract In AHU	dB	3	3	3	3	3	3	3	3
50mm Panel Transmission Loss (Rockwool - 100Kg/m3)	dB	-17	-20	-25	-25	-31	-33	-37	-31
SPL Panel	dB	84	75	67	66	57	51	42	40
Distance @ 1 metre (Corrected to Actual Test Values)	dB	-3	-3	-3	-3	-3	-3	-3	-3
RESULTANT Sound Pressure Level	dB	81	72	64	63	54	48	39	37

ATMOSPHERIC - Supply	Octave Band Centre Frequency								
	Hz	63	125	250	500	1000	2000	4000	8000
INLET - ATTENUATOR DUCT MOUNTED BY OTHERS									
Power Spectrum Inlet (Supply Fan)	SWL	87	86	84	86	81	78	73	66
Mounting Fans Within AHU Section	dB	4	4	4	4	4	4	4	4
AHU Mounted Component Losses	dB	-5	-4	-5	-6	-8	-11	-14	-16
Regenerated Noise Correction	dB	0	0	0	0	0	0	0	0
Sound Power Level To AHU Fresh Air Inlet	SWL	86	86	83	84	77	71	63	54

ROOMSIDE - Supply	Octave Band Centre Frequency								
	Hz	63	125	250	500	1000	2000	4000	8000
OUTLET - ATTENUATOR DUCT MOUNTED BY OTHERS									
Power Spectrum Outlet (Supply Fan)	SWL	94	88	85	84	81	77	72	64
Mounting Fans Within AHU Section	dB	4	4	4	4	4	4	4	4
Regenerated Noise Correction	dB	0	0	0	0	0	0	0	0
Sound Power Level To AHU Supply Air Outlet	SWL	98	92	89	88	85	81	76	68

ROOMSIDE - Extract	Octave Band Centre Frequency								
	Hz	63	125	250	500	1000	2000	4000	8000
INLET - ATTENUATOR DUCT MOUNTED BY OTHERS									
Power Spectrum Inlet (Extract Fan)	SWL	84	83	81	83	78	75	70	63
Mounting Fans Within AHU Section	dB	4	4	4	4	4	4	4	4
Regenerated Noise Correction	dB	0	0	0	0	0	0	0	0
Sound Power Level To AHU Return Air Inlet	SWL	88	87	85	87	82	79	74	67

ATMOSPHERIC - Extract	Octave Band Centre Frequency								
	Hz	63	125	250	500	1000	2000	4000	8000
OUTLET - ATTENUATOR DUCT MOUNTED BY OTHERS									
Power Spectrum Outlet (Extract Fan)	SWL	91	85	82	81	78	74	69	61
Mounting Fans Within AHU Section	dB	4	4	4	4	4	4	4	4
AHU Mounted Component Losses	dB	-3	-2	-3	-4	-5	-6	-7	-9
Regenerated Noise Correction	dB	0	0	0	0	0	0	0	0
Sound Power Level To AHU Exhaust Air Outlet	SWL	92	87	83	81	77	72	66	56

Dalair Limited (Technical Centre)

Project Reference : British Museum - WCEC

Client : Michael J Lonsdale

Date : Thursday 07th June 2012



Air Handling Unit Acoustic Analysis

AHU Reference : AHU/05/06 Supply & Extract (Supply Air Volume : 4.00 m3/s & Extract Air Volume 4.00 m3/s)

CASING	Octave Band Centre Frequency								
	Hz	63	125	250	500	1000	2000	4000	8000
RADIATED									
Power Spectrum (Fan + Includes 4dB for mounting fans within AHU section)	SWL	98	92	89	88	85	81	76	68
2 No Fans Running Together Supply & Extract In AHU	dB	3	3	3	3	3	3	3	3
50mm Panel Transmission Loss (Rockwool - 100Kg/m3)	dB	-17	-20	-25	-25	-31	-33	-37	-31
SPL Panel	dB	84	75	67	66	57	51	42	40
Distance @ 1 metre (Corrected to Actual Test Values)	dB	-3	-3	-3	-3	-3	-3	-3	-3
RESULTANT Sound Pressure Level	dB	81	72	64	63	54	48	39	37

ATMOSPHERIC - Supply	Octave Band Centre Frequency								
	Hz	63	125	250	500	1000	2000	4000	8000
INLET - ATTENUATOR DUCT MOUNTED BY OTHERS									
Power Spectrum Inlet (Supply Fan)	SWL	87	86	84	86	81	78	73	66
Mounting Fans Within AHU Section	dB	4	4	4	4	4	4	4	4
AHU Mounted Component Losses	dB	-5	-4	-5	-6	-8	-11	-14	-16
Regenerated Noise Correction	dB	0	0	0	0	0	0	0	0
Sound Power Level To AHU Fresh Air Inlet	SWL	86	86	83	84	77	71	63	54

ROOMSIDE - Supply	Octave Band Centre Frequency								
	Hz	63	125	250	500	1000	2000	4000	8000
OUTLET - ATTENUATOR DUCT MOUNTED BY OTHERS									
Power Spectrum Outlet (Supply Fan)	SWL	94	88	85	84	81	77	72	64
Mounting Fans Within AHU Section	dB	4	4	4	4	4	4	4	4
Regenerated Noise Correction	dB	0	0	0	0	0	0	0	0
Sound Power Level To AHU Supply Air Outlet	SWL	98	92	89	88	85	81	76	68

ROOMSIDE - Extract	Octave Band Centre Frequency								
	Hz	63	125	250	500	1000	2000	4000	8000
INLET - ATTENUATOR DUCT MOUNTED BY OTHERS									
Power Spectrum Inlet (Extract Fan)	SWL	85	84	82	84	79	76	71	64
Mounting Fans Within AHU Section	dB	4	4	4	4	4	4	4	4
Regenerated Noise Correction	dB	0	0	0	0	0	0	0	0
Sound Power Level To AHU Return Air Inlet	SWL	89	88	86	88	83	80	75	68

ATMOSPHERIC - Extract	Octave Band Centre Frequency								
	Hz	63	125	250	500	1000	2000	4000	8000
OUTLET - ATTENUATOR DUCT MOUNTED BY OTHERS									
Power Spectrum Outlet (Extract Fan)	SWL	92	86	83	82	79	75	70	62
Mounting Fans Within AHU Section	dB	4	4	4	4	4	4	4	4
AHU Mounted Component Losses	dB	-3	-2	-3	-4	-5	-6	-7	-9
Regenerated Noise Correction	dB	0	0	0	0	0	0	0	0
Sound Power Level To AHU Exhaust Air Outlet	SWL	93	88	84	82	78	73	67	57

Dalair Limited (Technical Centre)

Project Reference : British Museum - WCEC

Client : Michael J Lonsdale

Date : Thursday 07th June 2012



Air Handling Unit Acoustic Analysis

AHU Reference : AHU/05/07 Supply & Extract (Supply Air Volume : 4.20 m3/s & Extract Air Volume 4.20 m3/s)

CASING	Octave Band Centre Frequency								
	Hz	63	125	250	500	1000	2000	4000	8000
RADIATED									
Power Spectrum (Fan + Includes 4dB for mounting fans within AHU section)	SWL	98	92	89	88	85	81	76	68
2 No Fans Running Together Supply & Extract In AHU	dB	3	3	3	3	3	3	3	3
50mm Panel Transmission Loss (Rockwool - 100Kg/m3)	dB	-17	-20	-25	-25	-31	-33	-37	-31
SPL Panel	dB	84	75	67	66	57	51	42	40
Distance @ 1 metre (Corrected to Actual Test Values)	dB	-3	-3	-3	-3	-3	-3	-3	-3
RESULTANT Sound Pressure Level	dB	81	72	64	63	54	48	39	37

ATMOSPHERIC - Supply	Octave Band Centre Frequency								
	Hz	63	125	250	500	1000	2000	4000	8000
INLET - ATTENUATOR DUCT MOUNTED BY OTHERS									
Power Spectrum Inlet (Supply Fan)	SWL	87	86	84	86	81	78	73	66
Mounting Fans Within AHU Section	dB	4	4	4	4	4	4	4	4
AHU Mounted Component Losses	dB	-5	-4	-5	-6	-8	-11	-14	-16
Regenerated Noise Correction	dB	0	0	0	0	0	0	0	0
Sound Power Level To AHU Fresh Air Inlet	SWL	86	86	83	84	77	71	63	54

ROOMSIDE - Supply	Octave Band Centre Frequency								
	Hz	63	125	250	500	1000	2000	4000	8000
OUTLET - ATTENUATOR DUCT MOUNTED BY OTHERS									
Power Spectrum Outlet (Supply Fan)	SWL	94	88	85	84	81	77	72	64
Mounting Fans Within AHU Section	dB	4	4	4	4	4	4	4	4
Regenerated Noise Correction	dB	0	0	0	0	0	0	0	0
Sound Power Level To AHU Supply Air Outlet	SWL	98	92	89	88	85	81	76	68

ROOMSIDE - Extract	Octave Band Centre Frequency								
	Hz	63	125	250	500	1000	2000	4000	8000
INLET - ATTENUATOR DUCT MOUNTED BY OTHERS									
Power Spectrum Inlet (Extract Fan)	SWL	86	85	83	85	80	77	72	64
Mounting Fans Within AHU Section	dB	4	4	4	4	4	4	4	4
Regenerated Noise Correction	dB	0	0	0	0	0	0	0	0
Sound Power Level To AHU Return Air Inlet	SWL	90	89	87	89	84	81	76	68

ATMOSPHERIC - Extract	Octave Band Centre Frequency								
	Hz	63	125	250	500	1000	2000	4000	8000
OUTLET - ATTENUATOR DUCT MOUNTED BY OTHERS									
Power Spectrum Outlet (Extract Fan)	SWL	93	87	84	83	80	76	71	63
Mounting Fans Within AHU Section	dB	4	4	4	4	4	4	4	4
AHU Mounted Component Losses	dB	-3	-2	-3	-4	-5	-6	-7	-9
Regenerated Noise Correction	dB	0	0	0	0	0	0	0	0
Sound Power Level To AHU Exhaust Air Outlet	SWL	94	89	85	83	79	74	68	58

Dalair Limited (Technical Centre)

Project Reference : British Museum - WCEC

Client : Michael J Lonsdale

Date : Thursday 07th June 2012



Air Handling Unit Acoustic Analysis

AHU Reference : AHU/05/08 Supply & Extract (Supply Air Volume : 4.60 m3/s & Extract Air Volume 4.60 m3/s)

CASING	Octave Band Centre Frequency								
	Hz	63	125	250	500	1000	2000	4000	8000
RADIATED									
Power Spectrum (Fan + Includes 4dB for mounting fans within AHU section)	SWL	100	94	91	90	87	83	78	70
2 No Fans Running Together Supply & Extract In AHU	dB	3	3	3	3	3	3	3	3
50mm Panel Transmission Loss (Rockwool - 100Kg/m3)	dB	-17	-20	-25	-25	-31	-33	-37	-31
SPL Panel	dB	86	77	69	68	59	53	44	42
Distance @ 1 metre (Corrected to Actual Test Values)	dB	-3	-3	-3	-3	-3	-3	-3	-3
RESULTANT Sound Pressure Level	dB	83	74	66	65	56	50	41	39

ATMOSPHERIC - Supply	Octave Band Centre Frequency								
	Hz	63	125	250	500	1000	2000	4000	8000
INLET - ATTENUATOR DUCT MOUNTED BY OTHERS									
Power Spectrum Inlet (Supply Fan)	SWL	89	88	86	88	83	80	75	68
Mounting Fans Within AHU Section	dB	4	4	4	4	4	4	4	4
AHU Mounted Component Losses	dB	-5	-4	-5	-6	-8	-11	-14	-16
Regenerated Noise Correction	dB	0	0	0	0	0	0	0	0
Sound Power Level To AHU Fresh Air Inlet	SWL	88	88	85	86	79	73	65	56

ROOMSIDE - Supply	Octave Band Centre Frequency								
	Hz	63	125	250	500	1000	2000	4000	8000
OUTLET - ATTENUATOR DUCT MOUNTED BY OTHERS									
Power Spectrum Outlet (Supply Fan)	SWL	96	90	87	86	83	79	74	66
Mounting Fans Within AHU Section	dB	4	4	4	4	4	4	4	4
Regenerated Noise Correction	dB	0	0	0	0	0	0	0	0
Sound Power Level To AHU Supply Air Outlet	SWL	100	94	91	90	87	83	78	70

ROOMSIDE - Extract	Octave Band Centre Frequency								
	Hz	63	125	250	500	1000	2000	4000	8000
INLET - ATTENUATOR DUCT MOUNTED BY OTHERS									
Power Spectrum Inlet (Extract Fan)	SWL	84	83	81	86	82	79	74	66
Mounting Fans Within AHU Section	dB	4	4	4	4	4	4	4	4
Regenerated Noise Correction	dB	0	0	0	0	0	0	0	0
Sound Power Level To AHU Return Air Inlet	SWL	88	87	85	90	86	83	78	70

ATMOSPHERIC - Extract	Octave Band Centre Frequency								
	Hz	63	125	250	500	1000	2000	4000	8000
OUTLET - ATTENUATOR DUCT MOUNTED BY OTHERS									
Power Spectrum Outlet (Extract Fan)	SWL	90	85	83	84	82	78	73	64
Mounting Fans Within AHU Section	dB	4	4	4	4	4	4	4	4
AHU Mounted Component Losses	dB	-3	-2	-3	-4	-5	-6	-7	-9
Regenerated Noise Correction	dB	0	0	0	0	0	0	0	0
Sound Power Level To AHU Exhaust Air Outlet	SWL	91	87	84	84	81	76	70	59



ALLAWAY ACOUSTIC
LIMITED

Allaway Acoustics Ltd

Acoustical Analysis

Atmosphere Noise Calculation – ATT/05/01 AHU/05/01 FAI

Component	Octave Band Centre Frequencies (Hz)							
	63	125	250	500	1k	2k	4k	8k
FAI:								
DALAIR SWL	89	89	86	87	80	74	66	57
- Mitre Bend 1.5m	-1	-5	-8	-4	-3	-3	-3	-3
=	88	84	78	83	77	71	63	54
- Primary Attenuator Insertion loss	9	16	27	38	43	30	24	15
=	79	68	51	45	34	41	39	39
+ Attenuator self regenerated LW (at 5.2m3/s total airflow)	+56	+56	+51	+52	+51	+50	+49	+42
= LW in duct after primary attenuator	79	68	54	52	51	50	49	44
- Secondary Attenuator Insertion Loss	-13	-22	-34	-47	-55	-44	-35	-21
=	66	46	20	3	0	6	14	23
+ Attenuator regenerated LW	+54	+54	+49	+50	+49	+48	+47	+40
= LW in duct after secondary attenuator	66	55	49	50	49	48	47	40

Atmos Lp calculated by others



Allaway Acoustics Ltd

Acoustical Analysis

Atmosphere Noise Calculation – ATT/05/01 AHU/05/01 FAI

Component	Octave Band Centre Frequencies (Hz)							
	63	125	250	500	1k	2k	4k	8k
FAI:								
DALAIR SWL	89	89	86	87	80	74	66	57
- Mitre Bend 1.5m	-1	-5	-8	-4	-3	-3	-3	-3
=	88	84	78	83	77	71	63	54
- Primary Attenuator Insertion loss	9	16	27	38	43	30	24	15
=	79	68	51	45	34	41	39	39
+ Attenuator self regenerated LW (at 5.2m3/s total airflow)	+56	+56	+51	+52	+51	+50	+49	+42
= LW in duct after primary attenuator	79	68	54	52	51	50	49	44
- Secondary Attenuator Insertion Loss	-13	-22	-34	-47	-55	-44	-35	-21
=	66	46	20	3	0	6	14	23
+ Attenuator regenerated LW	+54	+54	+49	+50	+49	+48	+47	+40
= LW in duct after secondary attenuator	66	55	49	50	49	48	47	40
To Atmos								
- End Reflection (1.5mx0.5m)	-5	-1	0	0	0	0	0	0
- Distance 1m attenuation	-11	-11	-11	-11	-11	-11	-11	-11
- Directivity	0	0	0	0	0	0	0	0
+ Plane Source	+3	+3	+3	+3	+3	+3	+3	+3
+ contribution from other sources	+3	+3	+3	+3	+3	+3	+3	+3
= Resultant Lp at 1m from intake louvre	56	49	44	45	38	43	42	35
Equates to 49dBA at 1m distance								



Allaway Acoustics Ltd

Acoustical Analysis

Room Noise Calculation – ATT/05/14 AHU/05/04 SUPPLY

Calculation to Special Exhibition Galleries

Component	Octave Band Centre Frequencies (Hz)							
	63	125	250	500	1k	2k	4k	8k
SUPPLY:								
Dalair SWL	98	92	89	88	85	81	76	68
- Primary Attenuator Insertion loss	-9	-16	-27	-38	-43	-30	-24	-15
=	89	76	62	50	42	51	52	53
+ Attenuator self regenerated LW (at 3.8m3/s total airflow)	+48	+48	+43	+44	+43	+42	+41	+34
= LW in duct after primary attenuator	89	76	62	51	46	52	52	53
- Secondary Attenuator Insertion loss	-13	-22	-34	-47	-55	-44	-35	-21
=	76	54	28	4	0	8	17	32
+ Attenuator self regenerated LW (at 3.8m3/s total airflow)	+46	+46	+41	+42	+41	+40	+39	+32
= LW in duct after secondary attenuator	76	55	41	42	41	40	39	35
- LW split 28% into 0.406m	-6	-7	-11	-14	-10	-9	-9	-9
=	70	48	30	28	31	31	30	26
+ Bend regenerated LW	+27	+26	+21	+20	+18	+16	+13	+9
=	70	48	31	29	31	31	30	26
- Mitre Bend 0.406m	-0	-1	-5	-8	-4	-3	-3	-3
=	70	47	26	21	27	28	27	23
+ Bend regenerated LW	+27	+26	+21	+20	+18	+16	+13	+9
=	70	47	27	24	28	28	27	23
To Room								
End Reflection 0.315m	-10	-6	-2	0	0	0	0	0
Distance to listener 1.5m	-2	-2	-2	-2	-2	-2	-2	-2
Room Volume (20x20x6)	-17	-17	-17	-17	-17	-17	-17	-17
Other Grilles on system (3)	+6	+6	+6	+6	+6	+6	+6	+6
Other Sources (2)	+4	+4	+4	+4	+4	+4	+4	+4
Room Condition (Live)	+11	+10	+8	+8	+7	+6	+5	+4
= Room Sound Pressure Level	62	42	24	23	26	25	23	18

Equates to NR34

SG/2/15 published noise

NR38

Potential resultant room noise level =

NR39



Allaway Acoustics Ltd

Acoustical Analysis

Room Noise Calculation – ATT/05/02 AHU/05/01 SUPPLY

Calculation to Logistics Office & Reception

Component	Octave Band Centre Frequencies (Hz)							
	63	125	250	500	1k	2k	4k	8k
SUPPLY:								
Dalair SWL	101	95	92	91	88	84	79	71
- Primary Attenuator Insertion loss	-9	-16	-27	-38	-43	-30	-24	-15
=	92	79	65	53	45	54	55	56
+ Attenuator self regenerated LW (at 5.2m3/s total airflow)	+56	+56	+51	+52	+51	+50	+49	+42
= LW in duct after primary attenuator	92	79	65	56	52	55	56	56
- Mitre Bend 0.5m	-0	-1	-5	-8	-4	-3	-3	-3
=	92	78	60	46	48	52	53	53
+ Bend regenerated LW	+58	+57	+52	+51	+49	+47	+44	+40
=	92	78	61	52	52	53	54	53
- Secondary Attenuator Insertion loss	-13	-22	-34	-47	-55	-44	-35	-21
=	79	56	27	5	0	9	19	32
+ Attenuator self regenerated LW (at 5.2m3/s total airflow)	+54	+54	+49	+50	+49	+48	+47	+40
= LW in duct after primary attenuator	79	58	49	50	49	48	47	41
- Duct loss 0.5mx1.5m x 7.5Ml (lagged)	-13	-8	-6	-2	-2	-2	-2	-2
=	66	50	43	48	47	46	45	39
+ Duct regenerated LW	+38	+37	+32	+31	+29	+27	+24	+20
=	66	50	43	48	47	46	45	39
- Mitre Bend 0.5m	-0	-1	-5	-8	-4	-3	-3	-3
=	66	49	38	40	43	43	42	36
+ Bend regenerated LW	+58	+57	+52	+51	+49	+47	+44	+40
=	67	58	61	60	59	57	57	58
- LW split 44% into 0.45m	-4	-5	-9	-12	-8	-7	-7	-7
=	63	53	52	48	51	50	50	51
+ Bend regenerated LW	+50	+49	+44	+43	+41	+39	+36	+32
=	63	54	53	49	51	50	50	51
- LW split 54% into 0.787m	-4	-4	-8	-11	-7	-6	-6	-6
=	59	50	45	38	44	44	44	45
+ Bend regenerated LW	+43	+42	+37	+36	+34	+32	+29	+25
=	59	51	46	40	44	44	44	45
ATT/06/02 Insertion loss	-4	-8	-15	-21	-25	-19	-14	-8
=	55	43	31	19	19	25	30	37
+ Attenuator self regenerated LW (at 1.614m3/s total airflow)	+38	+38	+33	+34	+33	+32	+31	+24

= LW in duct after attenuator	55	44	35	34	33	33	34	37
- LW split 45% into 0.632m	-3	-4	-8	-11	-7	-6	-6	-6
=	52	40	47	23	26	26	27	31
+ Bend regenerated LW	+36	+35	+30	+29	+27	+25	+22	+18
=	52	41	47	30	30	29	28	31
- LW split 20% into 0.2m	-7	-7	-8	-8	-12	-15	-11	-10
=	45	34	39	22	18	14	17	21
+ Bend regenerated LW	+26	+25	+20	+19	+17	+15	+12	+8
=	45	35	39	24	21	18	18	13
+ TROX VAV/06/11 Lw	+55	+49	+43	+39	+37	+35	+32	+29
=	55	49	44	39	37	35	32	29
- LW split 50% into 0.355m	-3	-3	-4	-8	-11	-7	-6	-6
=	52	46	40	31	26	28	26	23
+ Bend regenerated LW	+0	+0	+0	+0	+0	+0	+0	+0
=	52	46	40	31	26	28	26	23
+ Radius bend 0.2m	-0	-1	-1	-2	-3	-3	-3	-3
=	52	45	39	29	23	25	23	20
+ Bend regenerated LW	+0	+0	+0	+0	+0	+0	+0	+0
=	52	45	39	29	23	25	23	20
To Room								
End Reflection 0.2m	-13	-9	-5	-1	0	0	0	0
Distance to listener 1.5m	-2	-2	-2	-2	-2	-2	-2	-2
Room Volume (12x10x2.6)	-12	-12	-12	-12	-12	-12	-12	-12
Other Grilles on system (4)	+6	+6	+6	+6	+6	+6	+6	+6
Other Sources (5)	+7	+7	+7	+7	+7	+7	+7	+7
Room Condition (Live)	+11	+10	+8	+8	+7	+6	+5	+4
= Room Sound Pressure Level	49	45	41	35	29	30	27	23
Equates to NR33								

SG/06/05-11 Published noise
Potential resultant room noise level =

NR38 (worst case SG/06/09)
NR39



Allaway Acoustics Ltd

Acoustical Analysis

Atmosphere Noise Calculation – ATT/05/03 AHU/05/01 Exhaust

Component	Octave Band Centre Frequencies (Hz)							
	63	125	250	500	1k	2k	4k	8k
Exhaust:								
DALAIR SWL	94	90	87	87	84	79	73	62
- Primary Attenuator Insertion loss	9	16	27	38	43	30	24	15
=	85	73	60	49	41	49	49	47
+ Attenuator self regenerated LW (at 5.2m ³ /s total airflow)	+56	+56	+51	+52	+51	+50	+49	+42
= LW in duct after primary attenuator	85	73	61	54	51	53	52	48
- Mitre Bend 0.5m	-0	-1	-5	-8	-4	-3	-3	-3
=	85	72	56	46	47	50	49	45
+ Bend regenerated LW	+58	+57	+52	+51	+49	+47	+44	+40
=	85	72	57	52	51	52	50	46
- Secondary Attenuator Insertion Loss	-13	-22	-34	-47	-55	-44	-35	-21
=	72	50	23	5	0	8	15	25
+ Attenuator regenerated LW	+54	+54	+49	+50	+49	+48	+47	+40
= LW in duct after secondary attenuator	72	55	49	50	49	48	47	40
- Duct loss 0.5mx1.5m x 5M (unlagged)	-6	-4	-2	-1	-1	-1	-1	-1
=	66	51	47	49	48	47	46	39
+ Duct regenerated LW	+38	+37	+32	+31	+29	+27	+24	+20
=	66	51	47	49	48	47	46	39
- Mitre Bend 0.45m	-0	-1	-5	-8	-4	-3	-3	-3
=	66	50	42	41	44	44	43	36
+ Bend regenerated LW	+58	+57	+52	+51	+49	+47	+44	+40
=	67	58	52	51	50	49	47	41
- Duct loss 1.1mx0.45m x 6M (unlagged)	-9	-6	-3	-2	-2	-2	-2	-2
=	58	52	49	49	48	47	45	39
+ Duct regenerated LW	+38	+37	+32	+31	+29	+27	+24	+20
=	58	52	49	49	48	47	45	39

Atmos Lp calculated by others

+ contribution from other sources	+3	+3	+3	+3	+3	+3	+3	+3
= Resultant Lp at 1m from exhaust louvre	47	45	44	44	43	42	40	34
Equates to 49dBA at 1m distance								



Allaway Acoustics Ltd

Acoustical Analysis

Atmosphere Noise Calculation – ATT/05/13 AHU/05/04 FAI

Component	Octave Band Centre Frequencies (Hz)							
	63	125	250	500	1k	2k	4k	8k
FAI:								
DALAIR SWL	86	86	83	84	77	71	63	54
- Mitre Bend 1.5m	-1	-5	-8	-4	-3	-3	-3	-3
=	85	81	75	80	74	68	60	51
- Primary Attenuator Insertion loss	9	16	27	38	43	30	24	15
=	76	65	48	42	31	38	36	36
+ Attenuator self regenerated LW (at 3.8m3/s total airflow)	+48	+48	+43	+44	+43	+42	+41	+34
= LW in duct after primary attenuator	76	65	49	46	43	43	41	38
- Secondary Attenuator Insertion Loss	-13	-22	-34	-47	-55	-44	-35	-21
=	63	43	15	0	0	0	6	17
+ Attenuator regenerated LW	+46	+46	+41	+42	+41	+40	+39	+32
= LW in duct after secondary attenuator	63	48	41	42	41	40	39	32

Atmos Lp calculated by others



Allaway Acoustics Ltd

Acoustical Analysis

Atmosphere Noise Calculation – ATT/05/13 AHU/05/04 FAI

Component	Octave Band Centre Frequencies (Hz)							
	63	125	250	500	1k	2k	4k	8k
FAI:								
DALAIR SWL	86	86	83	84	77	71	63	54
- Mitre Bend 1.5m	-1	-5	-8	-4	-3	-3	-3	-3
=	85	81	75	80	74	68	60	51
- Primary Attenuator Insertion loss	9	16	27	38	43	30	24	15
=	76	65	48	42	31	38	36	36
+ Attenuator self regenerated LW (at 3.8m ³ /s total airflow)	+48	+48	+43	+44	+43	+42	+41	+34
= LW in duct after primary attenuator	76	65	49	46	43	43	41	38
- Secondary Attenuator Insertion Loss	-13	-22	-34	-47	-55	-44	-35	-21
=	63	43	15	0	0	0	6	17
+ Attenuator regenerated LW	+46	+46	+41	+42	+41	+40	+39	+32
= LW in duct after secondary attenuator	63	48	41	42	41	40	39	32
To Atmos								
- End Reflection (1.5mx0.5m)	-5	-1	0	0	0	0	0	0
- Distance 1m attenuation	-11	-11	-11	-11	-11	-11	-11	-11
- Directivity	0	0	0	0	0	0	0	0
+ Plane Source	+3	+3	+3	+3	+3	+3	+3	+3
+ contribution from other sources	+3	+3	+3	+3	+3	+3	+3	+3
= Resultant Lp at 1m from intake louvre	53	42	36	37	36	35	34	27
Equates to 42dBA at 1m distance								



Allaway Acoustics Ltd

Acoustical Analysis

Atmosphere Noise Calculation – ATT/05/16 AHU/05/04 Exhaust

Component	Octave Band Centre Frequencies (Hz)							
	63	125	250	500	1k	2k	4k	8k
Exhaust:								
DALAIR SWL	92	87	83	81	77	72	66	56
- Primary Attenuator Insertion loss	9	16	27	38	43	30	24	15
=	83	71	56	43	34	42	42	41
+ Attenuator self regenerated LW (at 3.8m ³ /s total airflow)	+48	+48	+43	+44	+43	+42	+41	+34
= LW in duct after primary attenuator	83	71	56	47	44	45	45	42
- Mitre Bend 0.5m	-0	-1	-5	-8	-4	-3	-3	-3
=	85	72	56	46	47	50	49	45
+ Bend regenerated LW	+50	+49	+44	+43	+41	+39	+36	+32
=	82	72	56	48	48	50	49	45
- Secondary Attenuator Insertion Loss	-13	-22	-34	-47	-55	-44	-35	-21
=	69	50	22	1	0	6	14	24
+ Attenuator regenerated LW	+46	+46	+41	+42	+41	+40	+39	+32
= LW in duct after secondary attenuator	69	51	41	42	41	40	39	33
- Duct loss 0.5mx1.5m x 4.5M (unlagged)	-7	-4	-3	-1	-1	-1	-1	-1
=	62	47	38	41	40	39	38	32
+ Duct regenerated LW	+30	+29	+24	+23	+21	+19	+16	+12
=	62	47	38	41	40	39	38	32
- Mitre Bend 0.45m	-0	-1	-5	-8	-4	-3	-3	-3
=	62	46	33	33	36	36	35	29
+ Bend regenerated LW	+52	+51	+46	+45	+43	+41	+38	+34
=	62	52	47	46	44	42	40	35
- Duct loss 1.1mx0.45m x 6M (unlagged)	-9	-6	-3	-2	-2	-2	-2	-2
=	53	56	44	44	42	40	38	33
+ Duct regenerated LW	+30	+29	+24	+23	+21	+19	+16	+12
=	53	56	44	44	42	40	38	33

Atmos Lp calculated by others

+ contribution from other sources	+3	+3	+3	+3	+3	+3	+3	+3
= Resultant Lp at 1m from exhaust louvre	42	49	39	39	37	35	33	28
Equates to 43dBA at 1m distance								



Allaway Acoustics Ltd

Acoustical Analysis

Atmosphere Noise Calculation – ATT/B2/05 AHU/B2/03 FAI

Component	Octave Band Centre Frequencies (Hz)							
	63	125	250	500	1k	2k	4k	8k
FAI:								
DALAIR SWL	92	91	89	91	86	83	78	71
- Attenuator Insertion loss	13	21	33	47	55	45	33	20
=	79	70	56	44	31	38	45	51
+ Attenuator self regenerated LW (at 8.7m3/s total airflow – combined with AHU/B2/04)	+56	+56	+51	+52	+51	+50	+49	+42
= LW in duct after attenuator	79	70	57	53	51	50	50	52
- Mitre Bend 1m	-1	-5	-8	-4	-3	-3	-3	-3
=	78	65	49	49	48	47	47	49
+ Bend regenerated LW	+53	+52	+47	+46	+44	+42	+39	+35
=	78	65	51	51	49	48	48	49
- Mitre Bend 1.8m	-5	-8	-4	-3	-3	-3	-3	-3
=	73	57	47	48	46	45	45	46
+ Bend regenerated LW	+53	+52	+47	+46	+44	+42	+39	+35
=	73	58	50	50	48	47	46	47
- Duct loss 1.8mx1m x 3MI (unlagged)	-3	-2	-1	-1	-1	-1	-1	-1
=	70	56	49	49	47	46	45	46
+ Duct regenerated LW	+33	+32	+27	+26	+24	+22	+19	+15
=	70	56	49	49	47	46	45	46
- Duct loss 2.7mx0.65m x 3MI (unlagged)	-3	-2	-2	-1	-1	-1	-1	-1
=	67	54	47	48	46	45	44	45
+ Duct regenerated LW	+33	+32	+27	+26	+24	+22	+19	+15
=	67	54	47	48	46	45	44	45
- Mitre Bend 0.65m	0	-1	-5	-8	-4	-3	-3	-3
=	67	53	42	40	42	42	41	42
+ Bend regenerated LW	+53	+52	+47	+46	+44	+42	+39	+35
=	67	56	48	47	46	45	43	43
- Duct loss 2.7mx0.65m x 7MI (unlagged)	-8	-5	-4	-1	-1	-1	-1	-1
=	59	51	44	46	45	44	42	42
+ Duct regenerated LW	+33	+32	+27	+26	+24	+22	+19	+15
=	59	51	44	46	45	44	42	42
- Acoustic Louvre (L/01/05)	-5	-6	-8	-11	-18	-25	-20	-16
=	53	45	36	35	27	19	22	26
+ Louvre Regen (ARUP spec max LW)	+55	+45	+40	+42	+40	+32	+30	+30
=	57	48	41	43	40	32	31	31

Atmos Lp calculated by others



Allaway Acoustics Ltd

Acoustical Analysis

Atmosphere Noise Calculation – ATT/B2/05 AHU/B2/03 FAI

Component	Octave Band Centre Frequencies (Hz)							
	63	125	250	500	1k	2k	4k	8k
FAI:								
DALAIR SWL	92	91	89	91	86	83	78	71
- Attenuator Insertion loss	13	21	33	47	55	45	33	20
=	79	70	56	44	31	38	45	51
+ Attenuator self regenerated LW (at 8.7m3/s total airflow – combined with AHU/B2/04)	+56	+56	+51	+52	+51	+50	+49	+42
= LW in duct after attenuator	79	70	57	53	51	50	50	52
- Mitre Bend 1m	-1	-5	-8	-4	-3	-3	-3	-3
=	78	65	49	49	48	47	47	49
+ Bend regenerated LW	+53	+52	+47	+46	+44	+42	+39	+35
=	78	65	51	51	49	48	48	49
- Mitre Bend 1.8m	-5	-8	-4	-3	-3	-3	-3	-3
=	73	57	47	48	46	45	45	46
+ Bend regenerated LW	+53	+52	+47	+46	+44	+42	+39	+35
=	73	58	50	50	48	47	46	47
- Duct loss 1.8mx1m x 3MI (unlagged)	-3	-2	-1	-1	-1	-1	-1	-1
=	70	56	49	49	47	46	45	46
+ Duct regenerated LW	+33	+32	+27	+26	+24	+22	+19	+15
=	70	56	49	49	47	46	45	46
- Duct loss 2.7mx0.65m x 3MI (unlagged)	-3	-2	-2	-1	-1	-1	-1	-1
=	67	54	47	48	46	45	44	45
+ Duct regenerated LW	+33	+32	+27	+26	+24	+22	+19	+15
=	67	54	47	48	46	45	44	45
- Mitre Bend 0.65m	0	-1	-5	-8	-4	-3	-3	-3
=	67	53	42	40	42	42	41	42
+ Bend regenerated LW	+53	+52	+47	+46	+44	+42	+39	+35
=	67	56	48	47	46	45	43	43
- Duct loss 2.7mx0.65m x 7MI (unlagged)	-8	-5	-4	-1	-1	-1	-1	-1
=	59	51	44	46	45	44	42	42
+ Duct regenerated LW	+33	+32	+27	+26	+24	+22	+19	+15
=	59	51	44	46	45	44	42	42
- Acoustic Louvre (L/01/05)	-5	-6	-8	-11	-18	-25	-20	-16
=	53	45	36	35	27	19	22	26
+ Louvre Regen (8.7m3/s)	+57	+56	+55	+53	+54	+54	+52	+44
=	58	56	55	53	54	54	52	44
To Atmos								
- End Reflection (2.7mx0.5m)	-5	-1	0	0	0	0	0	0

- Distance 1m attenuation	-11	-11	-11	-11	-11	-11	-11	-11
- Directivity	0	0	0	0	0	0	0	0
+ Plane Source	+3	+3	+3	+3	+3	+3	+3	+3
+ contribution from other sources	+3	+3	+3	+3	+3	+3	+3	+3
= Resultant Lp at 1m from intake louvre	48	50	50	48	49	49	47	39
Equates to 55dBA at 1m distance								

Other Grilles on system (3)	+5	+5	+5	+5	+5	+5	+5	+5
Other Sources (2)	+4	+4	+4	+4	+4	+4	+4	+4
Room Condition (Live)	+11	+10	+8	+8	+7	+6	+5	+4
= Room Sound Pressure Level	50	48	42	40	27	32	31	27
Equates to NR35								

SG/B1/70 – 76 published noise NR33
Potential resultant room noise level = NR37



Allaway Acoustics Ltd

Acoustical Analysis

Atmosphere Noise Calculation – ATT/B2/08 AHU/B2/03 Exhaust

Component	Octave Band Centre Frequencies (Hz)							
	63	125	250	500	1k	2k	4k	8k
Exhaust:								
DALAIR SWL	95	89	86	85	82	78	73	65
- Mitre Bend 1.3m	-1	-5	-8	-4	-3	-3	-3	-3
=	94	84	78	81	79	75	70	62
+ Bend regenerated LW	+42	+41	+36	+35	+33	+31	+28	+24
=	94	84	78	81	79	75	70	62
- Mitre Bend 0.9m	-1	-5	-8	-4	-3	-3	-3	-3
=	93	79	70	77	76	72	67	59
+ Bend regenerated LW	+42	+41	+36	+35	+33	+31	+28	+24
=	93	79	70	77	76	72	67	59
- Primary Attenuator Insertion loss	8	14	21	26	29	20	14	8
=	85	65	49	51	47	52	53	51
+ Attenuator self regenerated LW (at 7.2m3/s total airflow – combined AHU/B2/04)	+57	+57	+52	+53	+52	+51	+50	+43
= LW in duct after primary attenuator	85	66	54	55	53	55	55	52
- Secondary Attenuator Insertion loss	8	14	21	26	29	20	14	8
=	78	52	33	29	24	35	41	44
+ Attenuator self regenerated LW (at 7.2m3/s total airflow – combined AHU/B2/04)	+57	+57	+52	+53	+52	+51	+50	+43
= LW in duct after secondary attenuator	78	58	52	53	52	51	51	47
- Duct loss 1.3mx0.9m x 3MI (unlagged)	-3	-2	-1	-1	-1	-1	-1	-1
=	75	56	51	52	51	50	50	46
+ Duct regenerated LW	+33	+32	+27	+26	+24	+22	+19	+15
=	75	56	51	52	51	50	50	46
- Duct loss 2.4mx0.45m x 3MI (unlagged)	-4	-3	-2	-1	-1	-1	-1	-1
=	71	53	49	51	50	49	49	45
+ Duct regenerated LW	+33	+32	+27	+26	+24	+22	+19	+15
=	71	53	49	51	50	49	49	45
- Mitre Bend 0.45m	0	-1	-5	-8	-4	-3	-3	-3
=	71	52	44	43	46	46	46	42
+ Bend regenerated LW	+59	+58	+53	+52	+50	+48	+45	+41

=	71	59	54	53	51	50	49	45
- Duct loss 2.4mx0.45m x 7MI (unlagged)	-10	-7	-4	-2	-2	-2	-2	-2
=	61	52	50	51	49	48	47	43
+ Duct regenerated LW	+33	+32	+27	+26	+24	+22	+19	+15
=	61	52	50	51	49	48	47	43

Atmos Lp calculated by others



Allaway Acoustics Ltd

Acoustical Analysis

Atmosphere Noise Calculation – ATT/B2/08 AHU/B2/03 Exhaust

Component	Octave Band Centre Frequencies (Hz)							
	63	125	250	500	1k	2k	4k	8k
Exhaust:								
DALAIR SWL	95	89	86	85	82	78	73	65
- Mitre Bend 1.3m	-1	-5	-8	-4	-3	-3	-3	-3
=	94	84	78	81	79	75	70	62
+ Bend regenerated LW	+42	+41	+36	+35	+33	+31	+28	+24
=	94	84	78	81	79	75	70	62
- Mitre Bend 0.9m	-1	-5	-8	-4	-3	-3	-3	-3
=	93	79	70	77	76	72	67	59
+ Bend regenerated LW	+42	+41	+36	+35	+33	+31	+28	+24
=	93	79	70	77	76	72	67	59
- Primary Attenuator Insertion loss	8	14	21	26	29	20	14	8
=	85	65	49	51	47	52	53	51
+ Attenuator self regenerated LW (at 7.2m3/s total airflow – combined AHU/B2/04)	+57	+57	+52	+53	+52	+51	+50	+43
= LW in duct after primary attenuator	85	66	54	55	53	55	55	52
- Secondary Attenuator Insertion loss	8	14	21	26	29	20	14	8
=	78	52	33	29	24	35	41	44
+ Attenuator self regenerated LW (at 7.2m3/s total airflow – combined AHU/B2/04)	+57	+57	+52	+53	+52	+51	+50	+43
= LW in duct after secondary attenuator	78	58	52	53	52	51	51	47
- Duct loss 1.3mx0.9m x 3MI (unlagged)	-3	-2	-1	-1	-1	-1	-1	-1
=	75	56	51	52	51	50	50	46
+ Duct regenerated LW	+33	+32	+27	+26	+24	+22	+19	+15
=	75	56	51	52	51	50	50	46
- Duct loss 2.4mx0.45m x 3MI (unlagged)	-4	-3	-2	-1	-1	-1	-1	-1
=	71	53	49	51	50	49	49	45
+ Duct regenerated LW	+33	+32	+27	+26	+24	+22	+19	+15
=	71	53	49	51	50	49	49	45
- Mitre Bend 0.45m	0	-1	-5	-8	-4	-3	-3	-3
=	71	52	44	43	46	46	46	42
+ Bend regenerated LW	+59	+58	+53	+52	+50	+48	+45	+41

=	71	59	54	53	51	50	49	45
- Duct loss 2.4mx0.45m x 7MI (unlagged)	-10	-7	-4	-2	-2	-2	-2	-2
=	61	52	50	51	49	48	47	43
+ Duct regenerated LW	+33	+32	+27	+26	+24	+22	+19	+15
=	61	52	50	51	49	48	47	43
To Atmos								
End Reflection (2.4mx0.45m)	-4	0	0	0	0	0	0	0
- Distance 1m attenuation	-11	-11	-11	-11	-11	-11	-11	-11
- Directivity	0	0	0	0	0	0	0	0
+ Plane Source	+3	+3	+3	+3	+3	+3	+3	+3
+ contribution from other sources	+3	+3	+3	+3	+3	+3	+3	+3
= Resultant Lp at 1m from exhaust louvre	52	47	45	46	44	43	42	38
Equates to 50dBA at 1m distance								

APPENDIX 2

Unit noise test data

Norsonic 840 Measurement Report - Circuit 2

Norsonic 840 Measurement Report - Circuit 1

Dual Source Calculator

Third Band Distance Calculator

- o Airedale will remove all punched logos on chiller casework.



View of chiller. 2No to be mounted on roof.

Measurement Report of Sound Power Levels

Sound power of TURBOCHILL was measured 29/01/13 at CHILLER TEST BAY.
The measurement was carried out in accordance with standard ISO 9614-1.

The report is divided into six paragraphs as follows:

1. Source of noise
2. Acoustic environment
3. Instrumentation
4. Measurement procedure
5. Acoustic data

1. Source of noise

a) Description of the source

Name, model, serial number: TURBOCHILL, TTC23E514X70, 63232613.
Manufacturer, year of manufacture: AIREDALE, 2013.

Technical data

b) Description of the source under test

TTC23E514X70

Shape and dimensions : Parallelepiped, length 8.10 m, width 2.20 m, height 2.60 m.

Measurement surface : Parallelepiped, length 9.10 m, width 3.20 m, height 3.10 m.

Number of points: 40

The distribution of points on the surface is shown in Fig.1.

The coordinates of points and corresponding surface are given in Table 1.

c) Noise characteristic

Variability: No

Occurrence of cycle: No

Tonal quality: No

d) Operating conditions

2 COMPRESSORS 51% FANS 700RPM

e) Montage

ANTI VIBRATION MOUNTS

2. Acoustic environment

a) Environment description

b) Description of extraneous noise sources

c) Temperature, pressure, and humidity of air

Temperature: 28.0 °C

Air pressure: 101.0 kPa

Relative humidity: 45.0 %

d) Wind

Velocity: 0.0 m/s

Direction:

e) Devices and procedures to reduce extraneous noise

f) Description of gas / air flow

3. Instruments

a) Description of instruments (type, serial number, manufacturer)

Analyser: Real Time Analyser, nor 840, 18759, Norsonic, Norway

Probe: 50 AI, 6643, G.R.A.S., Denmark

Principle of probe: p - p

Microphones: 40 AI, 14733 / 14744, G.R.A.S., Denmark

Microphone calibrator: Nor-1251, 15300, Norsonic, Norway

Intensity calibrator: Nor-1254, 6879, Norsonic, Norway

Form of wind screen used:

Mounting of the intensity probe:

b) Calibration

Date: 29/01/13

Place: TEST CENTRE

Calibration of microphones

Calibration level: 114.0 dB

Frequency: 250 Hz

Sensitivity of channel A: -32.4 dB

Sensitivity of channel B: -32.9 dB

Using the intensity calibrator.

The instrument was suited for class 1 according to IEC 1043.

The results in the form P -RI index are in Table 2.

c) Pressure - residual intensity index

The results of measurement in the form P - RI index are in Table 2.

d) Place and date of the verification of the intensity measurement device

GRAS Denmark, 07/02/99

4. Measurement procedure

Description of the measurement

Setup of measurement

Bandwidth: 1/3 octave

Time constant: 1/8s F

Frequency range: 50 - 6300 Hz

1st measurement

Spacer length: 100 mm

Averaging time: 35 s

Frequency range: 50 - 500 Hz

2nd measurement

Spacer length: 8 mm

Averaging time: 4 s

Frequency range: 630 - 6300 Hz

Measurement of temporal variability of the sound field

F1 was not carried out.

5. Acoustic data

a) Table of indicators

The field indicators F1 to F4 and criteria are given in Table 3.

b) Sound power levels

Frequency range: 50 - 6300 Hz

Total sound power

LW: 86.9 dB

LW (A): 80.4 dB (A)

The calculated values of sound power level in all frequency bands are given in Fig. 3 and also in Table 4.

c) The predicted uncertainty in the sound power level determined

In table 4 are stated the maximum uncertainties predicted according to ISO 9614 - 1 (table 2 or equation B.3 of standard).

Sound power of TURBOCHILL was measured 29/01/13 at CHILLER TEST BAY. The measurement was carried out in accordance with standard ISO 9614-1.

The report is divided into six paragraphs as follows:

1. Source of noise
2. Acoustic environment
3. Instrumentation
4. Measurement procedure
5. Acoustic data

1. Source of noise

a) Description of the source

Name, model, serial number: TURBOCHILL, TTC23E514X70, 63232613.
Manufacturer, year of manufacture: AIREDALE, 2013.

Technical data

b) Description of the source under test

TTC23E514X70

Shape and dimensions : Parallelepiped, length 8.10 m, width 2.20 m, height 2.60 m.

Measurement surface : Parallelepiped, length 9.10 m, width 3.20 m, height 3.10 m.

Number of points: 40

The distribution of points on the surface is shown in Fig.1.

The coordinates of points and corresponding surface are given in Table 1.

c) Noise characteristic

Variability: No

Occurrence of cycle: No

Tonal quality: No

d) Operating conditions

2 COMPRESSORS 51% FANS 700RPM

e) Montage

ANTI VIBRATION MOUNTS

2. Acoustic environment

a) Environment description

CHILLER TEST BAY NEXT TO PRODUCTION AREA

b) Description of extraneous noise sources

c) Temperature, pressure, and humidity of air

Temperature: 28.0 °C

Air pressure: 101.0 kPa

Relative humidity: 45.0 %

d) Wind

Velocity: 0.0 m/s

Direction:

e) Devices and procedures to reduce extraneous noise

f) Description of gas / air flow

3. Instruments

a) Description of instruments (type, serial number, manufacturer)

Analyser: Real Time Analyser, nor 840, 18759, Norsonic, Norway

Probe: 50 Al, 6643, G.R.A.S., Denmark

Principle of probe: p - p

Microphones: 40 Al, 14733 / 14744, G.R.A.S., Denmark

Microphone calibrator: Nor-1251, 15300, Norsonic, Norway

Intensity calibrator: Nor-1254, 6879, Norsonic, Norway

Form of wind screen used:

Mounting of the intensity probe:

b) Calibration

Date: 29/01/13

Place: TEST CENTRE

Calibration of microphones

Calibration level: 114.0 dB

Frequency: 250 Hz

Sensitivity of channel A: -32.4 dB

Sensitivity of channel B: -32.9 dB

Intensity calibration

Using the intensity calibrator.

The instrument was suited for class 1 according to IEC 1043.

The results in the form P -RI index are in Table 2.

c) Pressure - residual intensity index

The results of measurement in the form P - RI index are in Table 2.

d) Place and date of the verification of the intensity measurement device

GRAS Denmark, 07/02/99

4. Measurement procedure

Description of the measurement

Setup of measurement

Bandwidth: 1/3 octave

Time constant: 1/8s F

Frequency range: 50 - 6300 Hz

1st measurement

Spacer length: 100 mm

Averaging time: 35 s

Frequency range: 50 - 500 Hz

2nd measurement

Spacer length: 8 mm

Averaging time: 4 s

Frequency range: 630 - 6300 Hz

Measurement of temporal variability of the sound field

Point: 25

Number of samples: 10

5. Acoustic data

a) Table of indicators

The field indicators F1 to F4 and criteria are given in Table 3.

b) Sound power levels

Frequency range: 50 - 6300 Hz

Total sound power

LW: 90.7 dB

LW (A): 83.4 dB (A)

The calculated values of sound power level in all frequency bands are given in Fig. 3 and also in Table 4.

c) The predicted uncertainty in the sound power level determined

In table 4 are stated the maximum uncertainties predicted according to ISO 9614 - 1 (table 2 or equation B.3 of standard).

TTC23E514X70. 63232613. Dual Source calculator. Circuits 1 & 2

Noise Source No1				
Frequency Third Octave(hz)	dB value	Frequency Single Octave(hz)	dB value	dB(A) value
50	72.5			
63	86.8	63	87.2	61.2
80	74.6			
100	73.4			
125	80.3	125	82.3	66.3
160	76.3			
200	80.4			
250	78.8	250	83.8	74.8
315	77.4			
400	76			
500	74.6	500	80.1	77.1
630	75.3			
800	76			
1000	75.7	1000	79.9	79.9
1250	73.3			
1600	69.8			
2000	67.9	2000	72.9	73.9
2500	65.7			
3150	64.2			
4000	63.2	4000	69.5	70.5
5000	66.2			
6300	62.0			
8000	60.0	8000	65.1	64.1
10k	58.2			
Overall			90.7	83.50

Noise Source No2				
Frequency Third Octave(hz)	dB value	Frequency Single Octave(hz)	dB value	dB(A) value
50	70.6			
63	82.4	63	83.0	57.0
80	70.9			
100	70.5			
125	75.8	125	78.4	62.4
160	73			
200	76.7			
250	75.6	250	80.2	71.2
315	73.4			
400	72.4			
500	72.1	500	77.1	74.1
630	72.5			
800	72.7			
1000	73.1	1000	76.9	76.9
1250	70			
1600	66.9			
2000	64.9	2000	70.4	71.4
2500	64.7			
3150	61.9			
4000	60.9	4000	66.8	67.8
5000	63.1			
6300	61.2			
8000	59.2	8000	64.3	63.3
10k	57.4			
Overall			86.9	80.50

Dual Noise Source No1 + No2				
Frequency Third Octave(hz)	dB value	Frequency Single Octave(hz)	dB value	dB(A) value
50	74.7			
63	88.1	63	88.6	62.6
80	76.1			
100	75.2			
125	81.6	125	83.8	67.8
160	78.0			
200	81.9			
250	80.5	250	85.4	76.4
315	78.9			
400	77.6			
500	76.5	500	81.9	78.9
630	77.1			
800	77.7			
1000	77.6	1000	81.7	81.7
1250	75.0			
1600	71.6			
2000	69.7	2000	74.8	75.8
2500	68.2			
3150	66.2			
4000	65.2	4000	71.4	72.4
5000	67.9			
6300	64.6			
8000	62.6	8000	67.7	66.7
10k	60.8			
Overall			92.2	85.26

Get Third Octave Values From 'Calculator' Worksheet

Noise Propagation

- Hemi-Spherical
- Linear Source
- Spherical
- Cuboid Distribution

Information :

Michael J Lonsdale.TTC23E514X70.63232613.Circuit 1&2 @ 3 metres sound pressure

Enter Dimensions Of Source

L: 8.1 metres
W : 2.2 metres
H: 2.6 metres

Octave-Band Sound Power Level, dB

63	88.6
125	83.8
250	85.4
500	81.9
1000	81.7
2000	74.8
4000	71.4
8000	67.7

Sound Power, dBA

63Hz	62.6
125Hz	67.8
250Hz	76.4
500Hz	78.9
1000Hz	81.7
2000Hz	75.8
4000Hz	72.4
8000Hz	66.7

Cuboid Sound Pressure @ 3 metres, dB

63	58
125	60
250	56
500	56
1000	49
2000	46
4000	42
8000	42

Cuboid Sound Pressure @ 3 metres, dBA

63	37
125	42
250	51
500	53
1000	56
2000	50
4000	47
8000	41

Overall
I

92.2

dB
Only

Overall

85.3

'A' Weighted

66.6

dB Only

59.6

'A' Weighted

AMR/Q005/59999E13
Michael J Lonsdale Limited
British Museum - Smoke Extract

Fläkt Woods Limited
 Axial Way
 Colchester CO4 5ZD, UK
 Tel: +44 (0) 1206 222555
 Fax: +44 (0) 1206 222777
 www.flaktwoods.com



Ref	Required Duty	Product Code	Motor Frame	Speed (rpm)	Sound Level (dB)	Motor Power (kW)	Full Load Current (A)	Starting Current (A)	Electrical Supply (V/Hz/ph)
ES/6A/01	115l/s @ 400Pa (static)	ILC - MS315L	Integral	2440		0.300	1.300		220-240/50/1
ES/6A/02	220l/s @ 650Pa (static)	ILC - MS355L	Integral	2340		0.610	2.600		220-240/50/1
ES/6A/03	110l/s @ 650Pa (static)	ILC - MS355L	Integral	2340		0.610	2.600		220-240/50/1
ES/6A/04	215l/s @ 400Pa (static)	35JM/16/2/5/8	(P) BT5	2840		0.215	1.420	3.300	220-240/50/1
ES/02/01	410l/s @ 400Pa (static)	40JM/16/2/5/8	(P) BT9	2840		0.480	3.100	6.700	220-240/50/1
ES/02/02	165l/s @ 650Pa (static)	ILC - MS355L	Integral	2340		0.610	2.600		220-240/50/1

AMR/Q005/59999E13 - ES/6A/01
 British Museum - Smoke Extract
 SuperLite - Tube Fans Metal
 ILC - MS315L

Fläkt Woods Limited
 Axial Way
 Colchester CO4 5ZD, UK
 Tel: +44 (0) 1206 222555
 Fax: +44 (0) 1206 222777
 www.flaktwoods.com



Product Specification

Requested Duty: 115l/s @ 400Pa (static)
 Actual Duty: 132l/s @ 527Pa (static)
 Obtained Duty: 115%

Fan Code: ILC - MS315L
 Fan Diameter: 315 mm
 Fan Speed: 2 Pole, 2440 rpm

Electrical Supply: 220-240volts 50Hz 1phase
 Rated Motor Power: 0.300 kW
 Full Load Current: 1.300 A
 Start Type: Direct on Line

Form of Running: B
 Fan Casing: Long Cased
 Motor Frame Size: Integral

Peak Power: 0.300 kW

	Sound Power Level Spectrum (Lw)								Lw	LpA @ 3.00m
	63Hz	125Hz	250Hz	500Hz	1KHz	2KHz	4KHz	8KHz		
Inlet	0dB	63dB	68dB	71dB	69dB	66dB	65dB	62dB	76dB	53dB
Outlet	0dB	62dB	67dB	65dB	68dB	67dB	64dB	64dB	74dB	52dB
Breakout	0dB	57dB	58dB	54dB	51dB	49dB	46dB	39dB	62dB	36dB

Special Features

Ancillaries & Price

Qty Price Total

TF315011: SuperLite - Tube Fans Metal: ILC - MS315L
 Duct mounting clamps
 Key Information White/black/white Traffolyte Labels - Loose

1.0
 2.0
 1.0

Despatch: 5.0 working weeks

Fläkt Woods Limited

Performance Chart

SuperLite - Tube Fans Metal



Project Name : British Museum
Quotation Number : 59999E12
Customer : Michael J Lonsdale Limited

Date: : Thursday, July 5, 2012
Fan Code : ILC - MS315L
Item Reference: : ES/6A/01

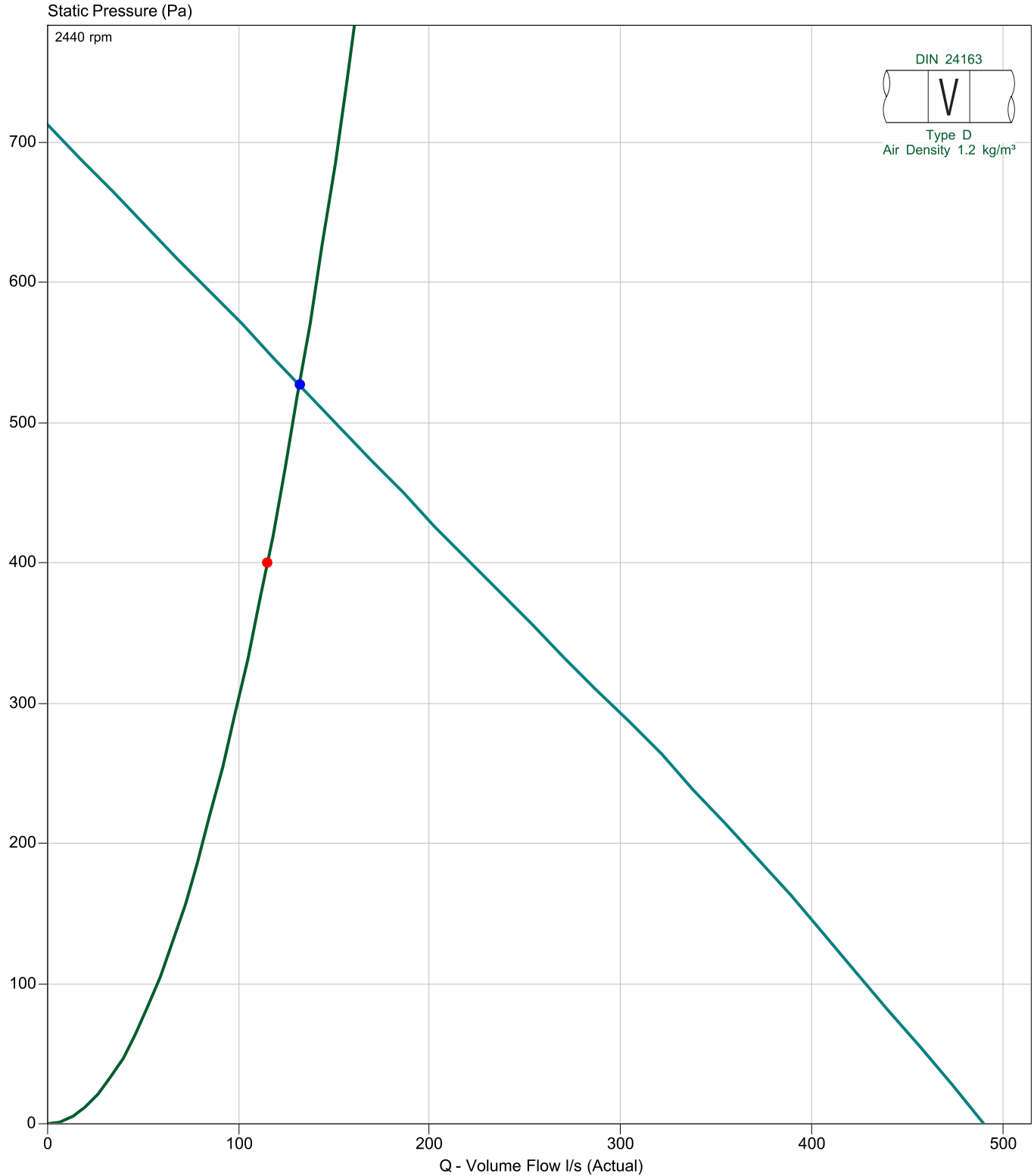

Axial Way
Colchester, Essex, CO45ZD
Tel: Fax:

Website: www.flaktwoods.com
Email: Allan.rumble@Flaktwoods.com
Copyright Fläkt Woods Group 2003 - 2012

Fläkt Woods Limited
Drawing and Dimensions
 SuperLite - T Tube Fans Metal



Date: : Thursday, July 5, 2012
 Fan Code : LC - MS315L
 Item Reference: : ES/6A/01

Project Name : British Museum
 Quotation Number : 59999E12
 Customer : Michael J Lonsdale Limited

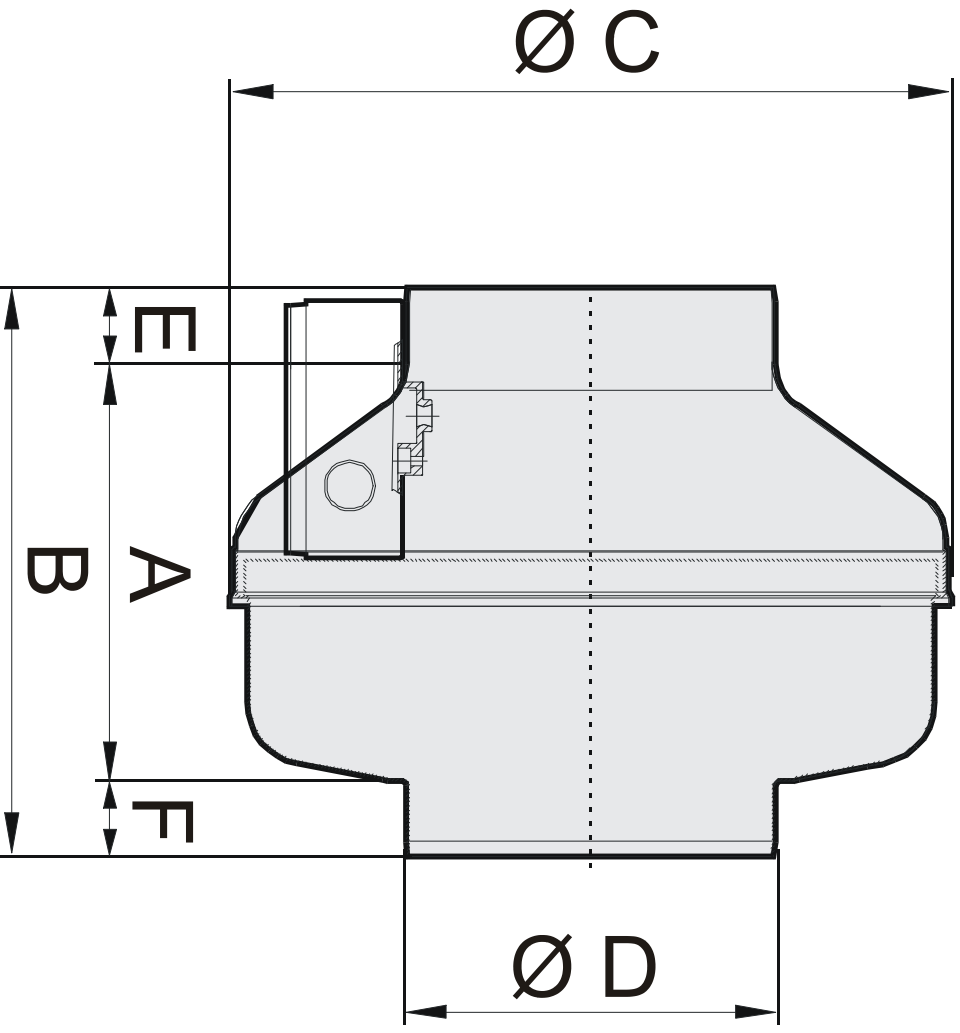

A	195
B	255
C	402
D	315
E	30
F	30
Weight	6

Notes : Dimensions shown in mm / Weight in kg
 This drawing shows dimensions that should be used as a guide only and are subject to change. Certified drawings are available on request.

Reference : Catalogue drawing

Axial Way
 Colchester, Essex, CO45ZD
 Tel: Fax:

AMR/Q005/59999E13 - ES/6A/02
 British Museum - Smoke Extract
 SuperLite - Tube Fans Metal
 ILC - MS355L

Fläkt Woods Limited
 Axial Way
 Colchester CO4 5ZD, UK
 Tel: +44 (0) 1206 222555
 Fax: +44 (0) 1206 222777
 www.flaktwoods.com



Product Specification

Requested Duty: 220l/s @ 650Pa (static)
 Actual Duty: 224l/s @ 674Pa (static)
 Obtained Duty: 102%

Fan Code: ILC - MS355L
 Fan Diameter: 355 mm
 Fan Speed: 2 Pole, 2340 rpm

Electrical Supply: 220-240volts 50Hz 1phase
 Rated Motor Power: 0.610 kW
 Full Load Current: 2.600 A
 Start Type: Direct on Line

Form of Running: B
 Fan Casing: Long Cased
 Motor Frame Size: Integral

Peak Power: 0.610 kW

	Sound Power Level Spectrum (Lw)								Lw	LpA @ 3.00m
	63Hz	125Hz	250Hz	500Hz	1KHz	2KHz	4KHz	8KHz		
Inlet	0dB	72dB	78dB	72dB	70dB	64dB	62dB	56dB	80dB	54dB
Outlet	0dB	73dB	69dB	72dB	72dB	69dB	65dB	61dB	79dB	55dB
Breakout	0dB	62dB	65dB	60dB	61dB	57dB	54dB	41dB	69dB	44dB

Special Features

Ancillaries & Price

Qty Price Total

TF355012: SuperLite - Tube Fans Metal: ILC - MS355L
 Duct mounting clamps
 Key Information White/black/white Traffolyte Labels - Loose

1.0
 2.0
 1.0

Despatch: 5.0 working weeks

Project Name : British Museum
Quotation Number : 59999E12
Customer : Michael J Lonsdale Limited

Date: : Thursday, July 5, 2012
Fan Code : ILC - MS355L
Item Reference: : ES/6A/02

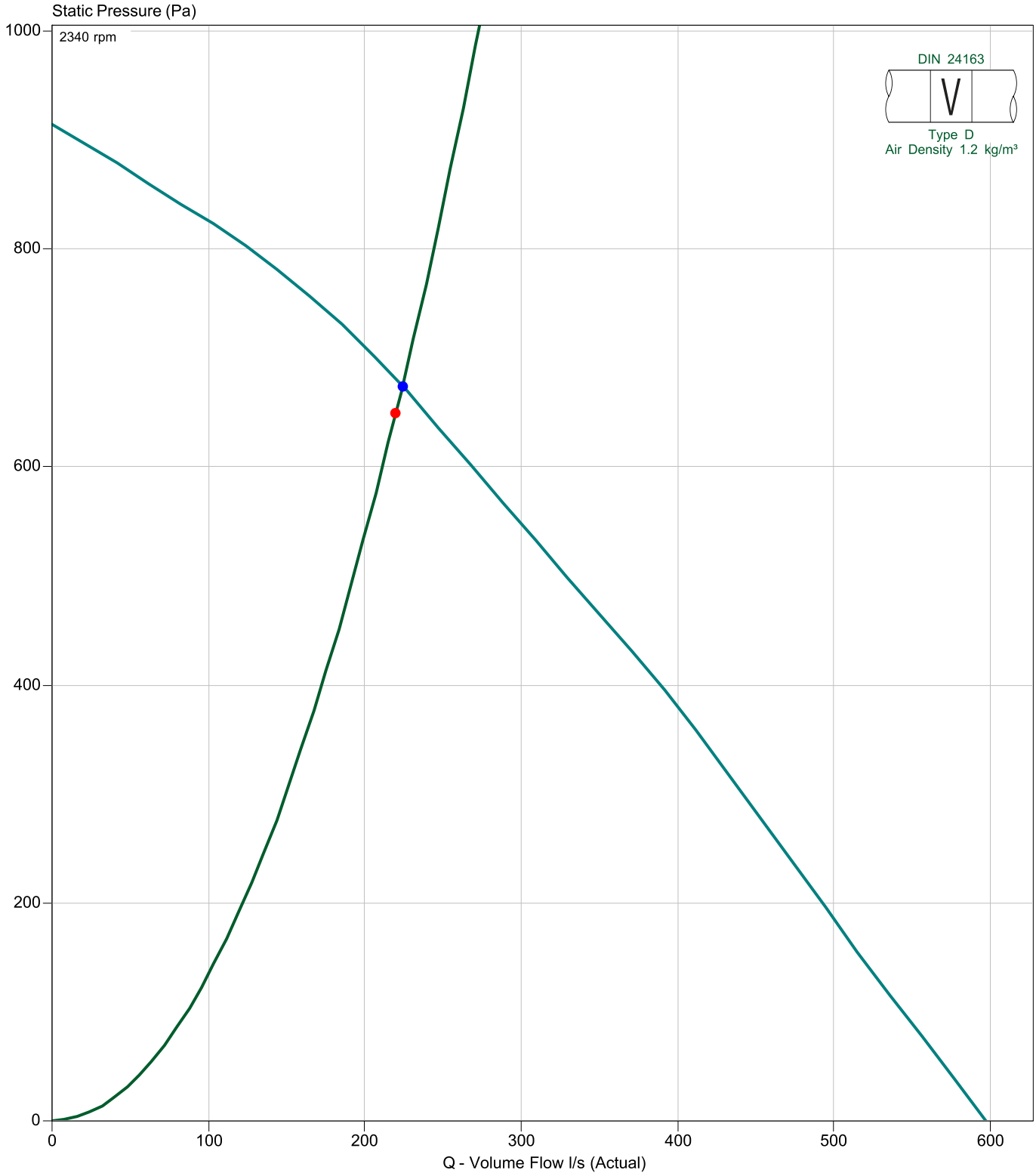

Fläkt Woods Limited
Drawing and Dimensions
 SuperLite - T Tube Fans Metal



Date: : Thursday, July 5, 2012
 Fan Code : LC - MS355L
 Item Reference: : ES/6A/02

Project Name : British Museum
 Quotation Number : 59999E12
 Customer : Michael J Lonsdale Limited

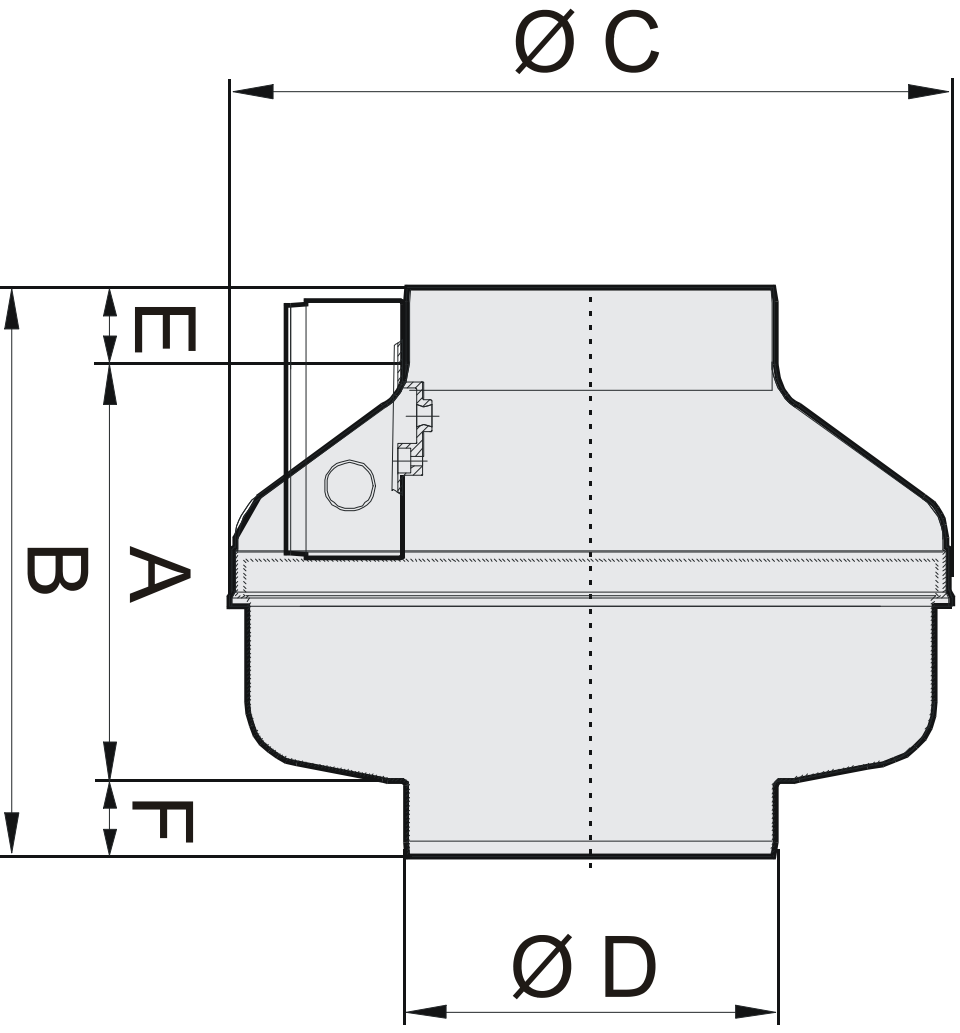

A	320
B	395
C	490
D	355
E	40
F	35
Weight	14

Notes : Dimensions shown in mm / Weight in kg
 This drawing shows dimensions that should be used as a guide only and are subject to change. Certified drawings are available on request.

Reference : Catalogue drawing

Axial Way
 Colchester, Essex, CO45ZD
 Tel: Fax:

AMR/Q005/59999E13 - ES/6A/03
 British Museum - Smoke Extract
 SuperLite - Tube Fans Metal
 ILC - MS355L

Fläkt Woods Limited
 Axial Way
 Colchester CO4 5ZD, UK
 Tel: +44 (0) 1206 222555
 Fax: +44 (0) 1206 222777
 www.flaktwoods.com



Product Specification

Requested Duty: 110l/s @ 650Pa (static)
 Actual Duty: 122l/s @ 804Pa (static)
 Obtained Duty: 111%

Fan Code: ILC - MS355L
 Fan Diameter: 355 mm
 Fan Speed: 2 Pole, 2340 rpm

Electrical Supply: 220-240volts 50Hz 1phase
 Rated Motor Power: 0.610 kW
 Full Load Current: 2.600 A
 Start Type: Direct on Line

Form of Running: B
 Fan Casing: Long Cased
 Motor Frame Size: Integral

Peak Power: 0.610 kW

	Sound Power Level Spectrum (Lw)								Lw	LpA @ 3.00m
	63Hz	125Hz	250Hz	500Hz	1KHz	2KHz	4KHz	8KHz		
Inlet	0dB	72dB	78dB	72dB	70dB	64dB	62dB	56dB	80dB	54dB
Outlet	0dB	73dB	69dB	72dB	72dB	69dB	65dB	61dB	79dB	55dB
Breakout	0dB	62dB	65dB	60dB	61dB	57dB	54dB	41dB	69dB	44dB

Special Features

Ancillaries & Price

Qty Price Total

TF355012: SuperLite - Tube Fans Metal: ILC - MS355L
 Duct mounting clamps
 Key Information White/black/white Traffolyte Labels - Loose

1.0
 2.0
 1.0

Despatch: 5.0 working weeks

Fläkt Woods Limited

Performance Chart

SuperLite - Tube Fans Metal



Project Name : British Museum
Quotation Number : 59999E12
Customer : Michael J Lonsdale Limited

Date: : Thursday, July 5, 2012
Fan Code : ILC - MS355L
Item Reference: : ES/6A/03

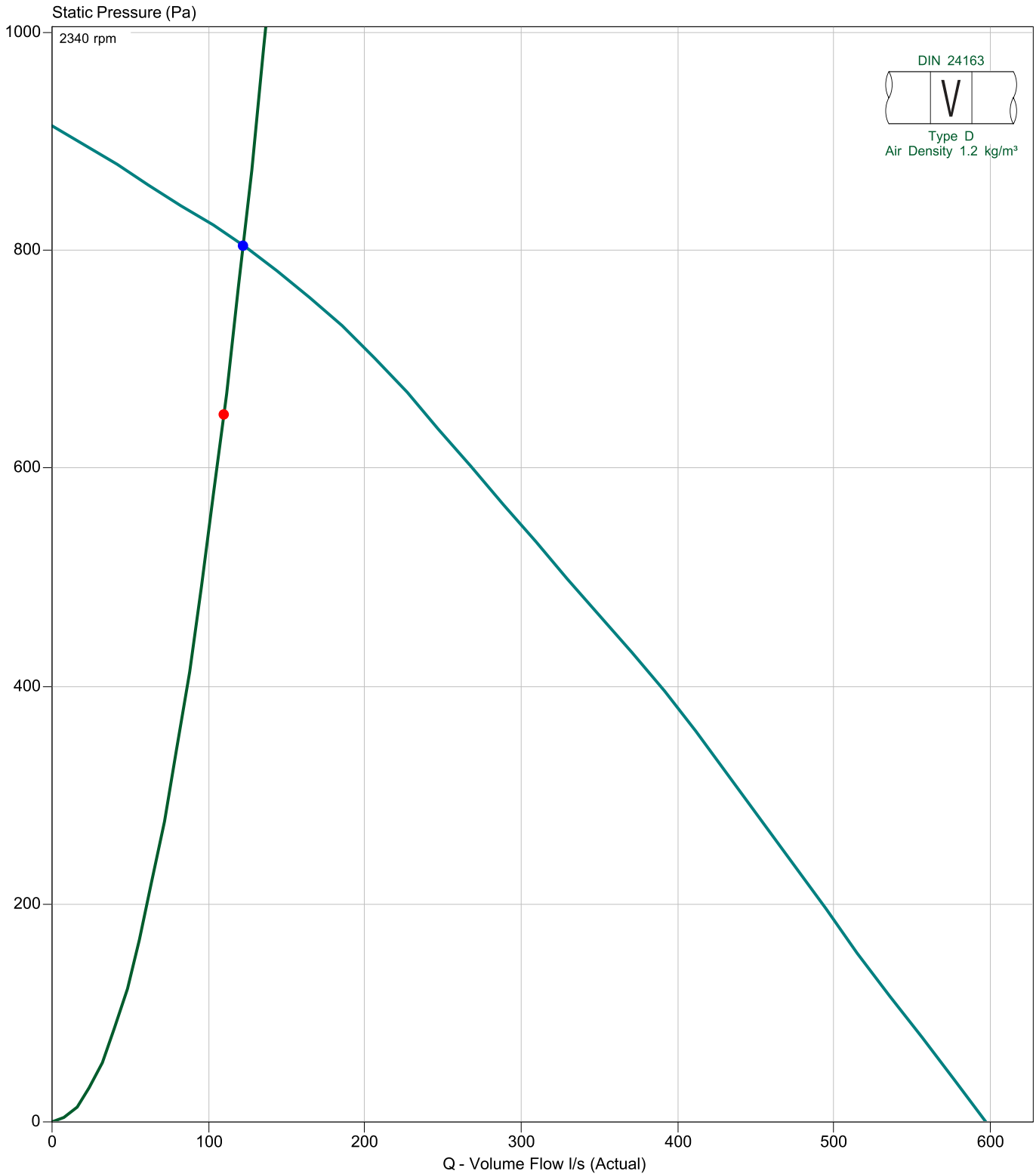

Axial Way
Colchester, Essex, CO45ZD
Tel: Fax:

Website: www.flaktwoods.com
Email: Allan.rumble@Flaktwoods.com
Copyright Fläkt Woods Group 2003 - 2012

Fläkt Woods Limited
Drawing and Dimensions
 SuperLite - T Tube Fans Metal



Date: : Thursday, July 5, 2012
 Fan Code : LC - MS355L
 Item Reference: : ES/6A/03

Project Name : British Museum
 Quotation Number : 59999E12
 Customer : Michael J Lonsdale Limited

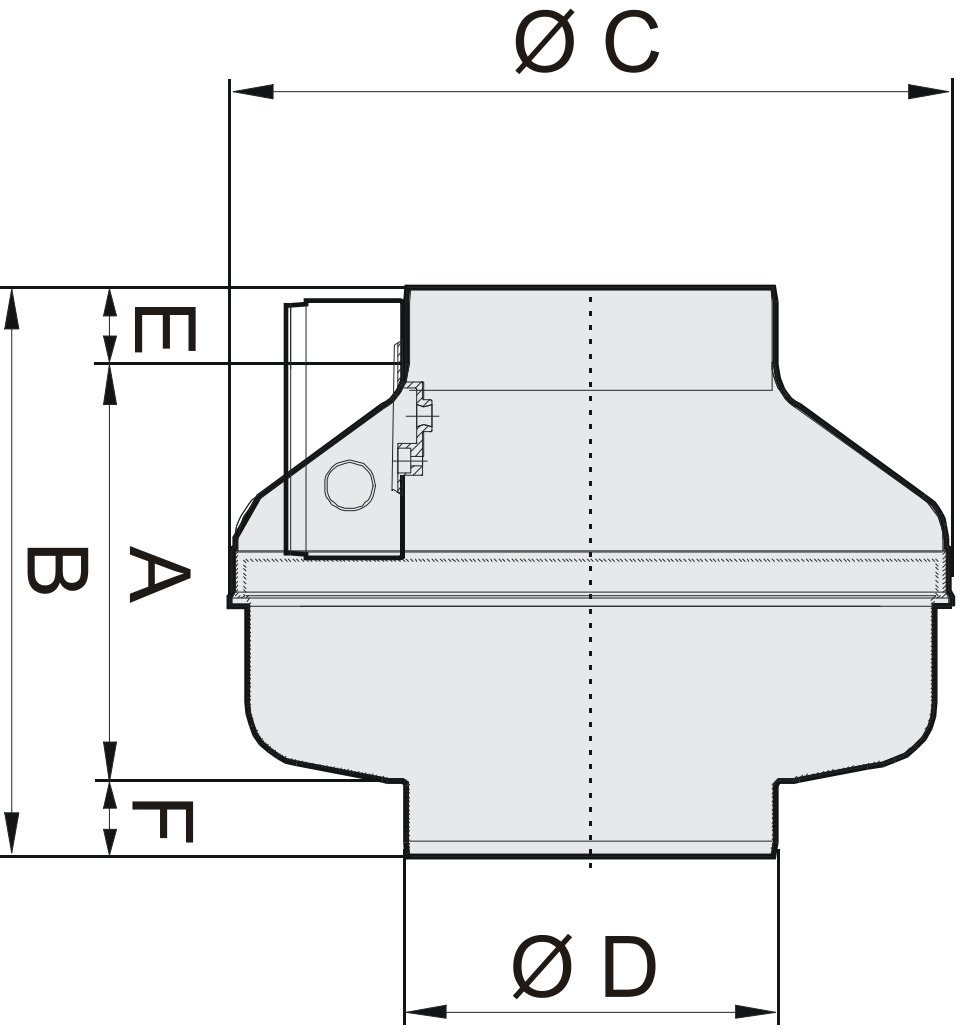

A	320
B	395
C	490
D	355
E	40
F	35
Weight	14



Notes : Dimensions shown in mm / Weight in kg
 This drawing shows dimensions that should be used as a guide only and are subject to change. Certified drawings are available on request.

Reference : Catalogue drawing

Axial Way
 Colchester, Essex, CO45ZD
 Tel: Fax:

AMR/Q005/59999E13 - ES/6A/04
 British Museum - Smoke Extract
 JM Aerofoil
 35JM/16/2/5/8

Fläkt Woods Limited
 Axial Way
 Colchester CO4 5ZD, UK
 Tel: +44 (0) 1206 222555
 Fax: +44 (0) 1206 222777
 www.flaktwoods.com



Product Specification

Requested Duty: 215l/s @ 400Pa (static)
 Actual Duty: 222l/s @ 425Pa (static)
 Obtained Duty: 103%

Fan Code: 35JM/16/2/5/8
 Fan Diameter: 355 mm
 Fan Hub Diameter: 160 mm
 Fan Speed: 2 Pole, 2840 rpm

Electrical Supply: 220-240volts 50Hz 1phase
 Rated Motor Power: 0.215 kW
 Full Load Current: 1.420 A
 Starting Current: 3.300 A
 Start Type: Direct on Line

No. of Blades: 5
 Pitch Angle: 8°
 Form of Running: B
 Fan Casing: Long Cased
 Motor Frame Size: (P) BT5

Absorbed Power: 0.208 kW
 Peak Power: 0.216 kW
 Fan Total Efficiency: 46%

	Sound Power Level Spectrum (Lw)								Lw	LpA @ 3.00m
	63Hz	125Hz	250Hz	500Hz	1KHz	2KHz	4KHz	8KHz		
Inlet	81dB	85dB	87dB	89dB	88dB	81dB	73dB	66dB	94dB	71dB
Outlet	84dB	86dB	89dB	90dB	89dB	82dB	73dB	67dB	95dB	72dB
Breakout	74dB	71dB	69dB	69dB	63dB	53dB	48dB	44dB	77dB	48dB

Special Features

Ancillaries & Price

Qty Price Total

JM Aerofoil: 35JM/16/2/5/8 1.0
 Set of Mounting Feet (2) 1.0
 Rubber Anti Vibration Mounts (set of 4) 1.0
 Matching Flange 2.0
 Flex connector c/w 2 clips 2.0
 Commissioning Damper 1.0
 Key Information White/black/white Traffolyte Labels - Fitted 1.0

Despatch: 9.0 working weeks

Project Name : British Museum
 Quotation Number : 59999E12
 Customer : Michael J Lonsdale Limited

Date : Thursday, July 5, 2012
 Fan Code : 35JM/16/2/5/8
 Item Reference: : ES/6A/04

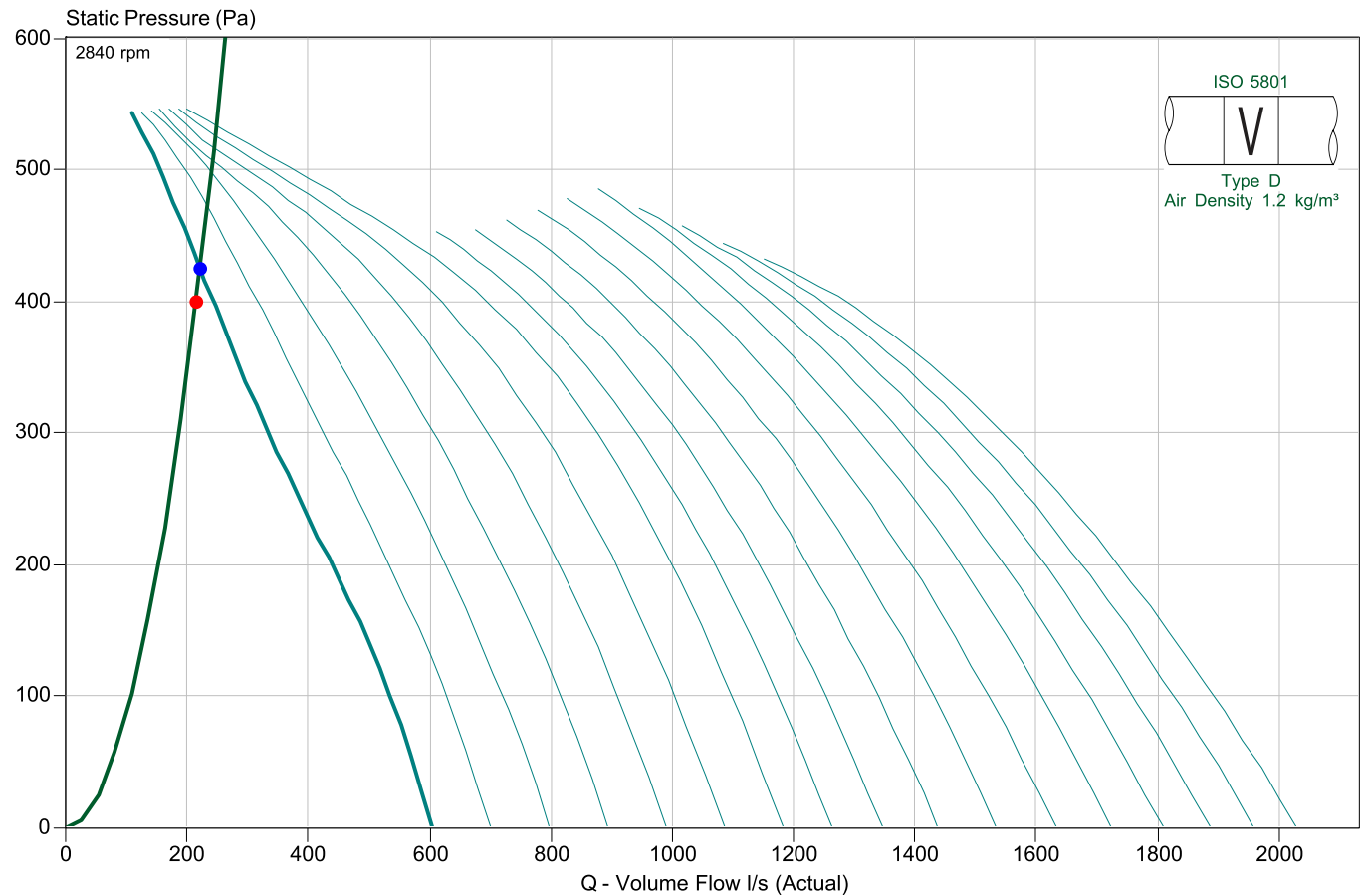
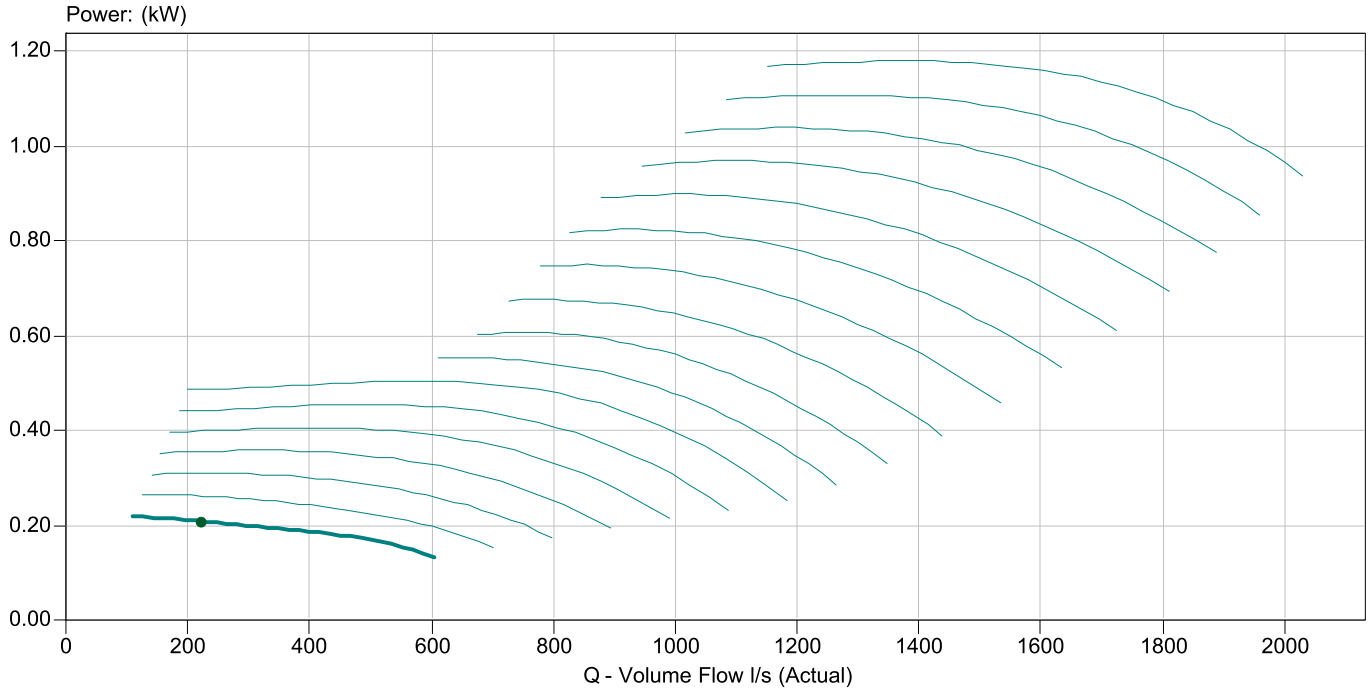

Fläkt Woods Limited

Drawing and Dimensions

JM Aerofoil

Date: : Thursday, July 5, 2012
 Fan Code : 35JM/16/2/5/8
 Item Reference: : ES/6A/04

Project Name : British Museum
 Quotation Number : 59999E12
 Customer : Michael J Lonsdale Limited

C 330
 K 245
 Weight 22

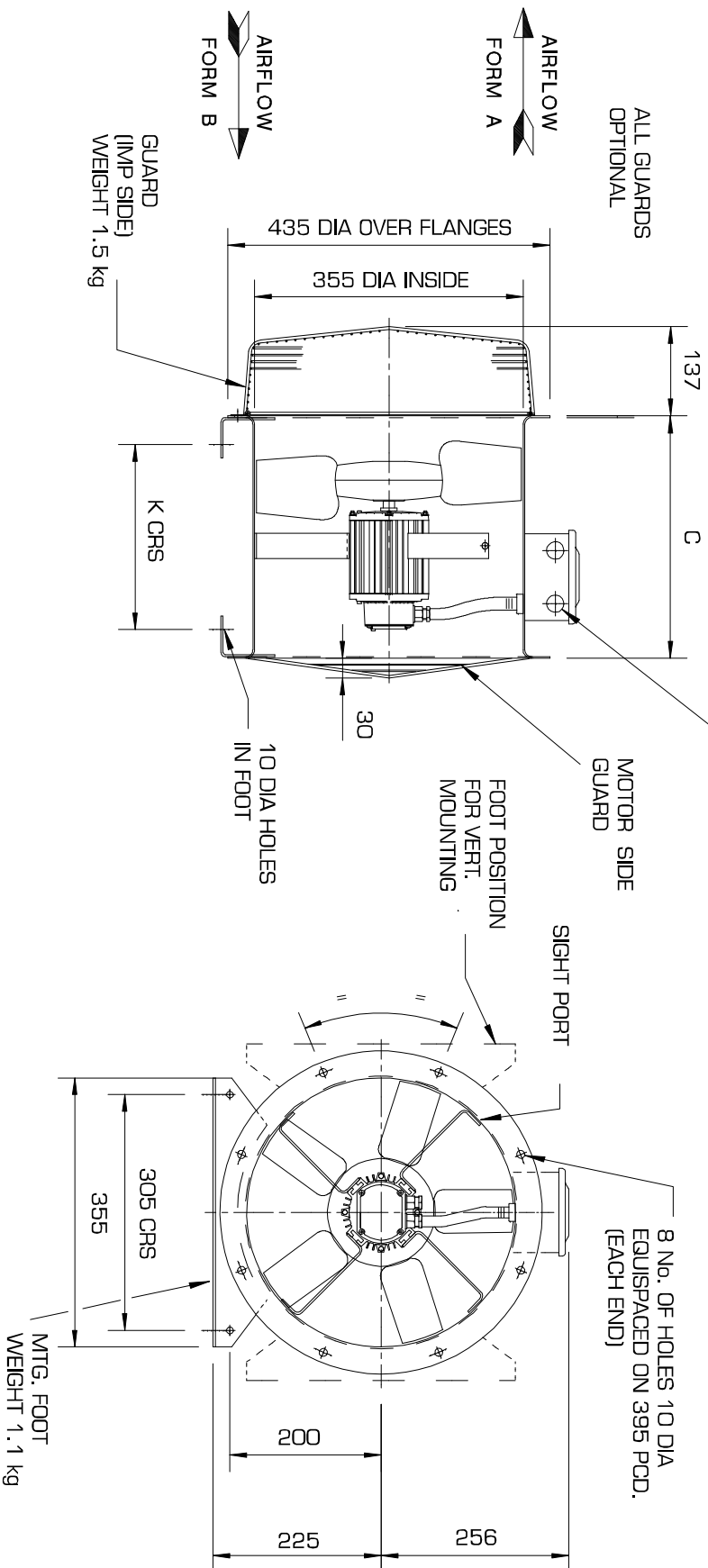

Notes : Dimensions shown in mm / Weight in kg

This drawing shows dimensions that should be used as a guide only and are subject to change. Certified drawings are available on request.

Reference : Catalogue drawing

Axial Way
 Colchester, Essex, CO45ZD
 Tel: Fax:

Website: www.flaktwoods.com
 Email: Allan.rumble@Flaktwoods.com
 Copyright Fläkt Woods Group 2003 - 2012

AMR/Q005/59999E13 - ES/02/01
 British Museum - Smoke Extract
 JM Aerofoil
 40JM/16/2/5/8

Fläkt Woods Limited
 Axial Way
 Colchester CO4 5ZD, UK
 Tel: +44 (0) 1206 222555
 Fax: +44 (0) 1206 222777
 www.flaktwoods.com



Product Specification

Requested Duty: 410l/s @ 400Pa (static)
 Actual Duty: 431l/s @ 443Pa (static)
 Obtained Duty: 105%

Fan Code: 40JM/16/2/5/8
 Fan Diameter: 400 mm
 Fan Hub Diameter: 160 mm
 Fan Speed: 2 Pole, 2840 rpm

Electrical Supply: 220-240volts 50Hz 1phase
 Rated Motor Power: 0.480 kW
 Full Load Current: 3.100 A
 Starting Current: 6.700 A
 Start Type: Direct on Line

No. of Blades: 5
 Pitch Angle: 8°
 Form of Running: B
 Fan Casing: Long Cased
 Motor Frame Size: (P) BT9

Absorbed Power: 0.355 kW
 Peak Power: 0.363 kW
 Fan Total Efficiency: 55%

	Sound Power Level Spectrum (Lw)								Lw	LpA @ 3.00m
	63Hz	125Hz	250Hz	500Hz	1KHz	2KHz	4KHz	8KHz		
Inlet	80dB	84dB	86dB	87dB	89dB	82dB	75dB	68dB	94dB	71dB
Outlet	83dB	85dB	89dB	89dB	89dB	84dB	75dB	69dB	95dB	72dB
Breakout	73dB	70dB	69dB	68dB	63dB	55dB	50dB	46dB	77dB	48dB

Special Features

Ancillaries & Price

Qty Price Total

JM Aerofoil: 40JM/16/2/5/8
 Set of Mounting Feet (2)
 Rubber Anti Vibration Mounts (set of 4)
 Matching Flange
 Flex connector c/w 2 clips
 Key Information White/black/white Traffolyte Labels - Fitted

1.0
 1.0
 1.0
 2.0
 2.0
 1.0

Despatch: 3.0 working weeks

Project Name : British Museum
 Quotation Number : 59999E12
 Customer : Michael J Lonsdale Limited

Date: : Thursday, July 5, 2012
 Fan Code : 40JM/16/2/5/8
 Item Reference: : ES/02/01

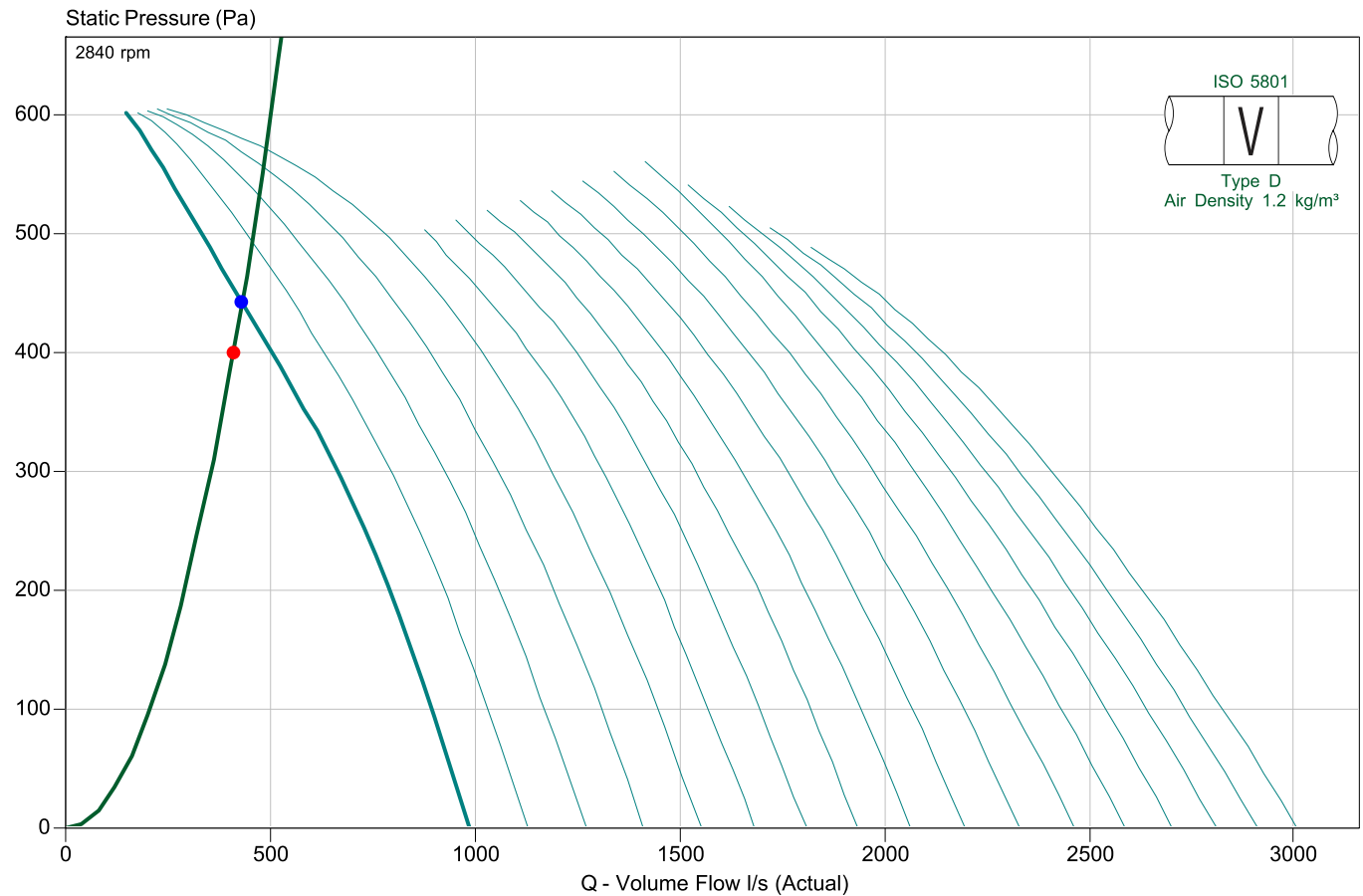
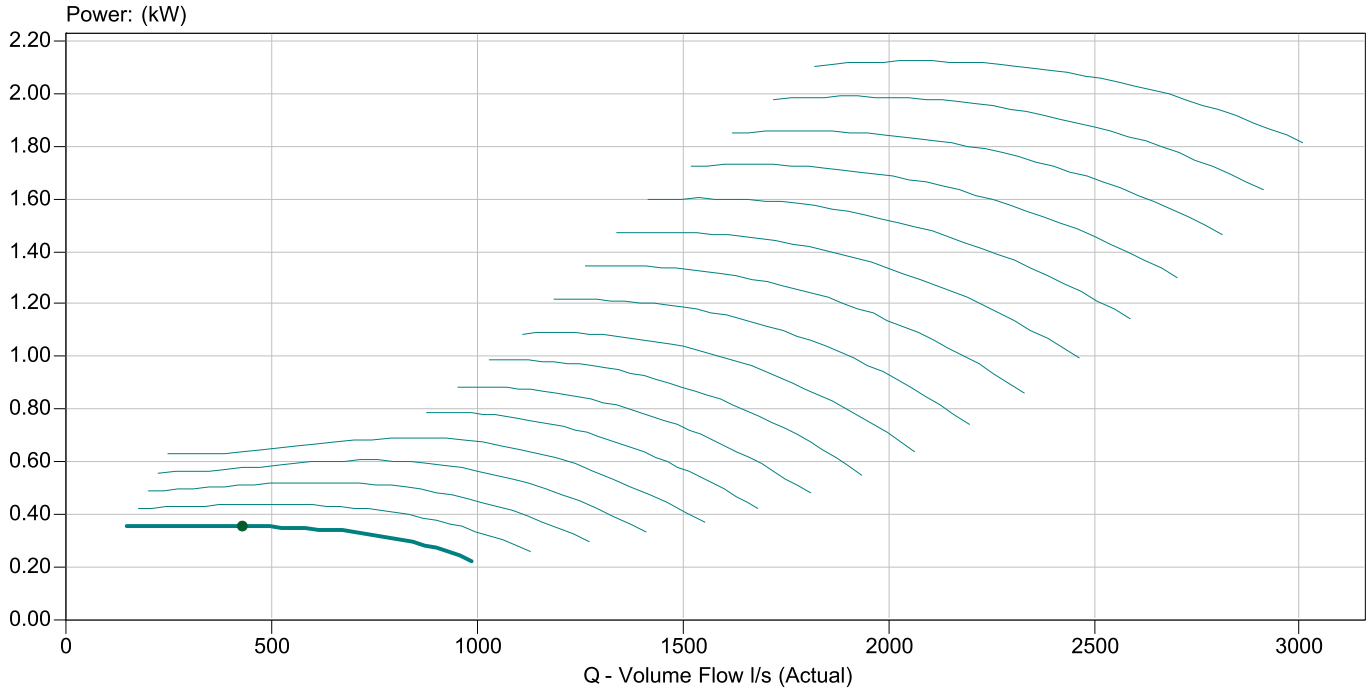

Fläkt Woods Limited

Drawing and Dimensions

JM Aerofoil

Date: : Thursday, July 5, 2012
 Fan Code : 40JM/16/2/5/8
 Item Reference: : ES/02/01

Project Name : British Museum
 Quotation Number : 59999E12
 Customer : Michael J Lonsdale Limited

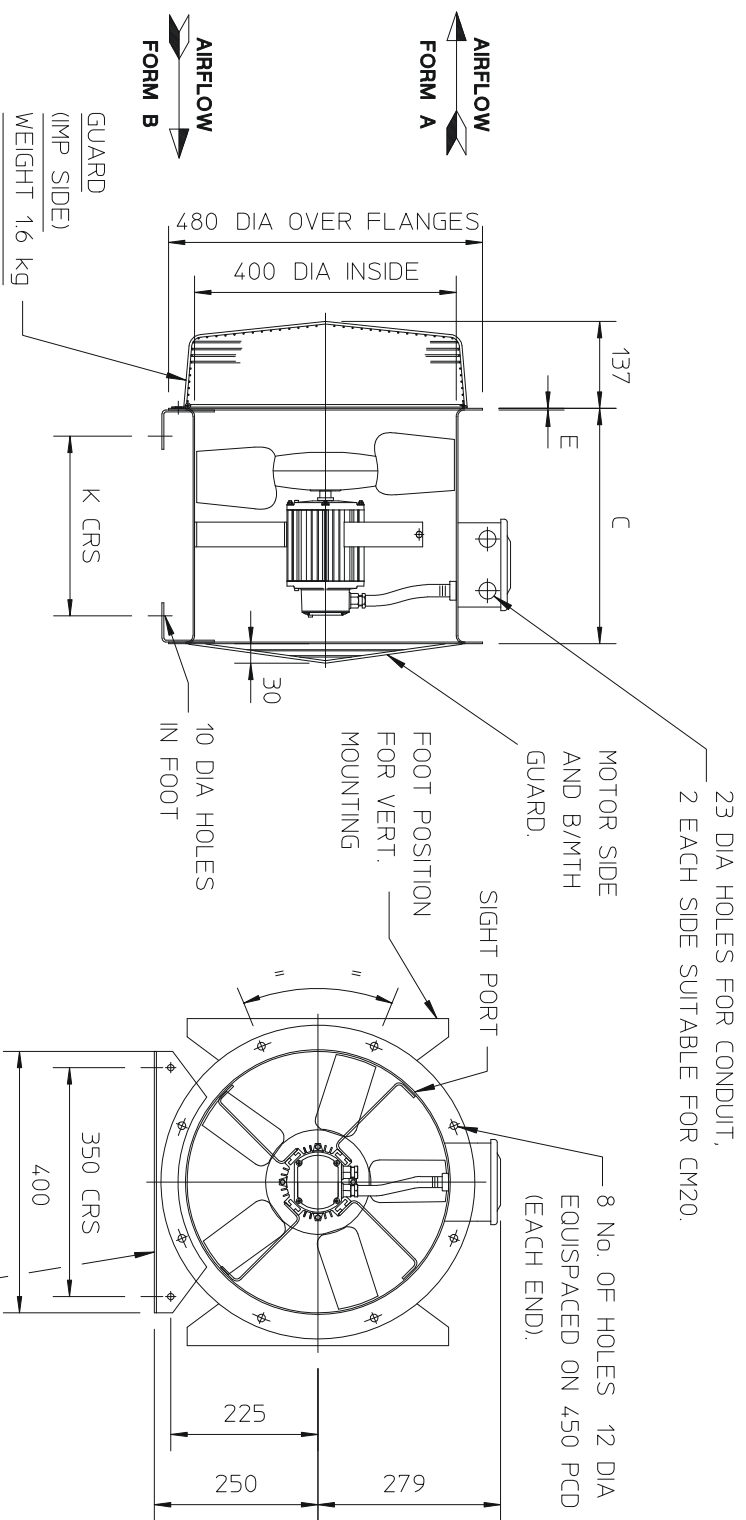

SIZE	FRAME	C	E	K	WEIGHT kg
400	BT5	330	2.0	245	24
	BT9	375	2.5	290	25
	CT5	330	2.0	245	26
	CT9	375	2.5	290	30

Notes : Dimensions shown in mm / Weight in kg
 This drawing shows dimensions that should be used as a guide only and are subject to change. Certified drawings are available on request.

Reference : D269016

Axial Way
 Colchester, Essex, CO45ZD
 Tel: Fax:
 Printed on Thursday, July 05, 2012

Page 12 of 12
 Website: www.flaktwoods.com
 Email: Allan.rumble@flaktwoods.com
 Copyright Fläkt Woods Group 2003 - 2012
 Selection Engine: 2.8.1.0b(1)(UK.3.6.0)

AMR/Q005/59999E13 - ES/02/02
 British Museum - Smoke Extract
 SuperLite - Tube Fans Metal
 ILC - MS355L

Fläkt Woods Limited
 Axial Way
 Colchester CO4 5ZD, UK
 Tel: +44 (0) 1206 222555
 Fax: +44 (0) 1206 222777
 www.flaktwoods.com



Product Specification

Requested Duty: 165l/s @ 650Pa (static)
 Actual Duty: 176l/s @ 742Pa (static)
 Obtained Duty: 107%

Fan Code: ILC - MS355L
 Fan Diameter: 355 mm
 Fan Speed: 2 Pole, 2340 rpm

Electrical Supply: 220-240volts 50Hz 1phase
 Rated Motor Power: 0.610 kW
 Full Load Current: 2.600 A
 Start Type: Direct on Line

Form of Running: B
 Fan Casing: Long Cased
 Motor Frame Size: Integral

Peak Power: 0.610 kW

	Sound Power Level Spectrum (Lw)								Lw	LpA @ 3.00m
	63Hz	125Hz	250Hz	500Hz	1KHz	2KHz	4KHz	8KHz		
Inlet	0dB	72dB	78dB	72dB	70dB	64dB	62dB	56dB	80dB	54dB
Outlet	0dB	73dB	69dB	72dB	72dB	69dB	65dB	61dB	79dB	55dB
Breakout	0dB	62dB	65dB	60dB	61dB	57dB	54dB	41dB	69dB	44dB

Special Features

Ancillaries & Price

Qty Price Total

TF355012: SuperLite - Tube Fans Metal: ILC - MS355L
 Duct mounting clamps
 Key Information White/black/white Traffolyte Labels - Loose

1.0
 2.0
 1.0

Despatch: 2.0 working weeks

Fläkt Woods Limited
Performance Chart
SuperLite - Tube Fans Metal



Project Name : British Museum
 Quotation Number : 59999E12
 Customer : Michael J Lonsdale Limited

Date: : Thursday, July 5, 2012
 Fan Code : ILC - MS355L
 Item Reference: : ES/02/02

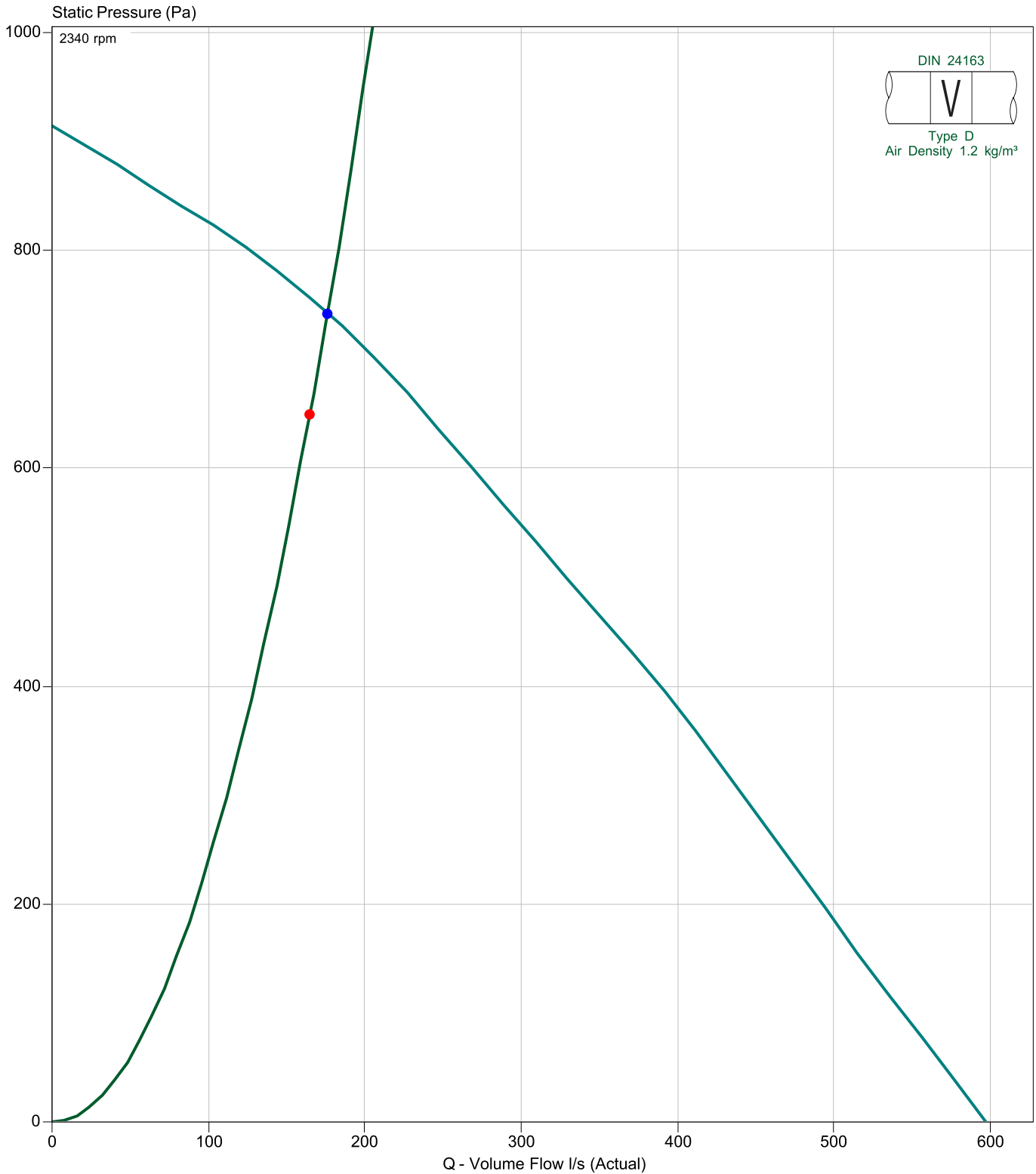

Axial Way
 Colchester, Essex, CO45ZD
 Tel: Fax:

Website: www.flaktwoods.com
 Email: Allan.rumble@Flaktwoods.com
 Copyright Fläkt Woods Group 2003 - 2012

Fläkt Woods Limited
Drawing and Dimensions
 SuperLite - T Tube Fans Metal



Date: : Thursday, July 5, 2012
 Fan Code : LC - MS355L
 Item Reference: : ES/02/02

Project Name : British Museum
 Quotation Number : 59999E12
 Customer : Michael J Lonsdale Limited

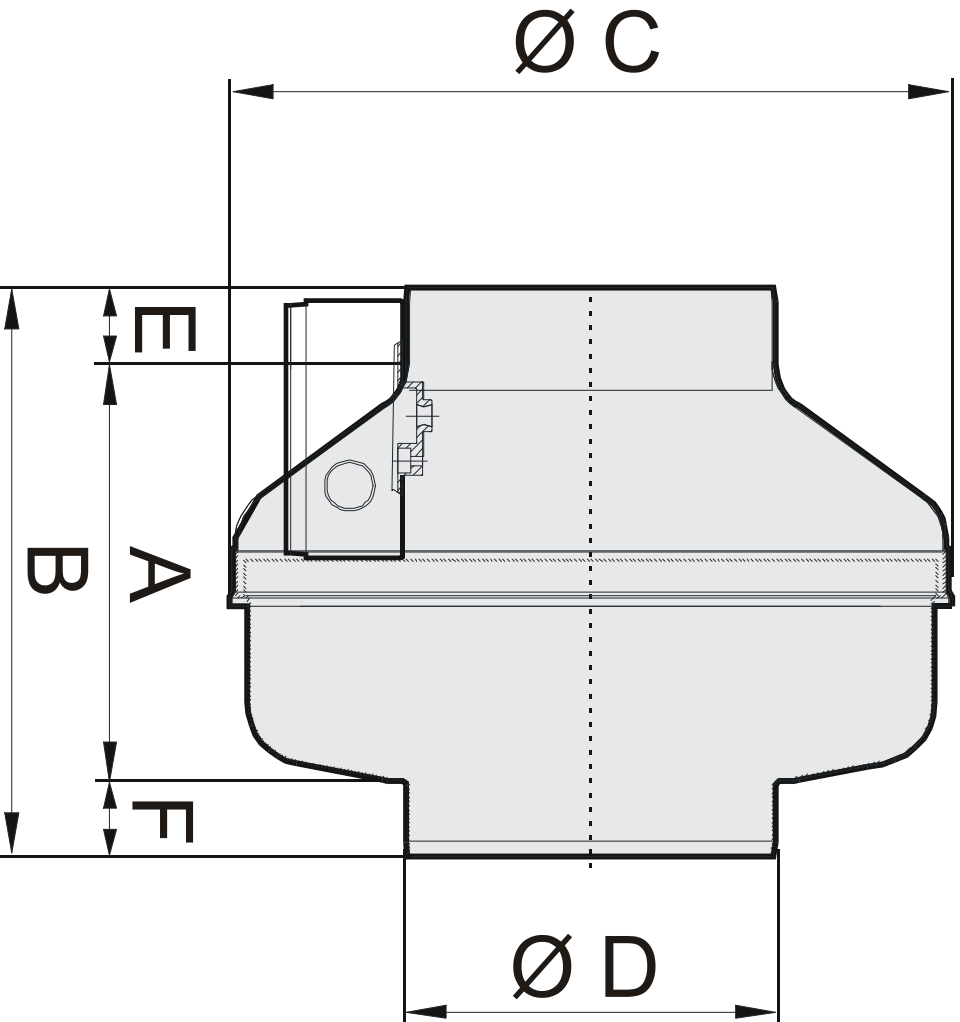

A	320
B	395
C	490
D	355
E	40
F	35
Weight	14

Notes : Dimensions shown in mm / Weight in kg
 This drawing shows dimensions that should be used as a guide only and are subject to change. Certified drawings are available on request.

Reference : Catalogue drawing

Axial Way
 Colchester, Essex, CO45ZD
 Tel: Fax: