

Proposed position of phone kiosk

Pavement in front of 104 Eversholt Street  
London NW1 1BP

pavement in front of 104 Eversholt Street, London NW1 1BP [1-250]

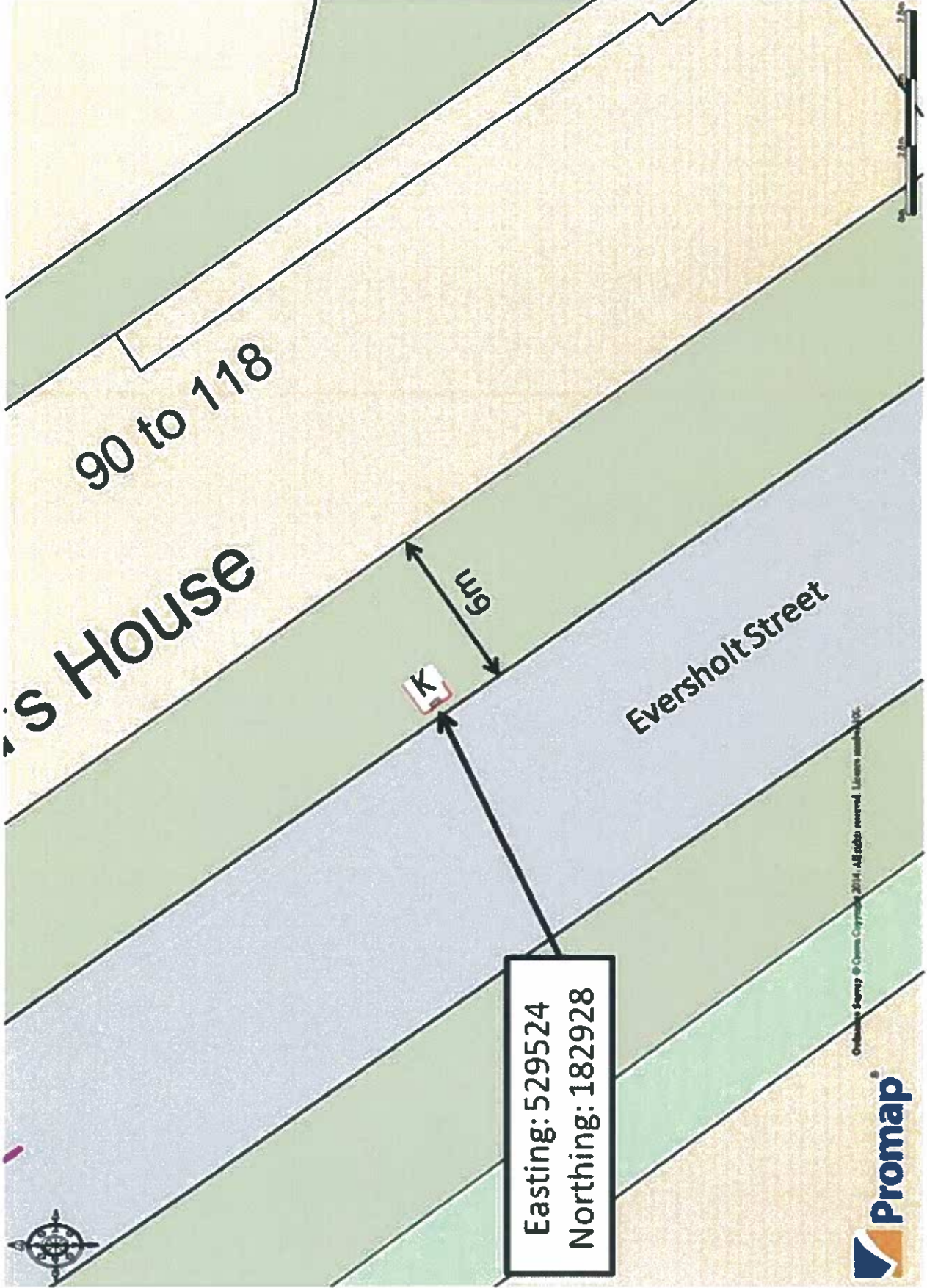

Easting: 529524  
Northing: 182928



Infocus Public Networks Ltd

pavement in front of 104 Eversholt Street, London NW1 1BP [1-1250]

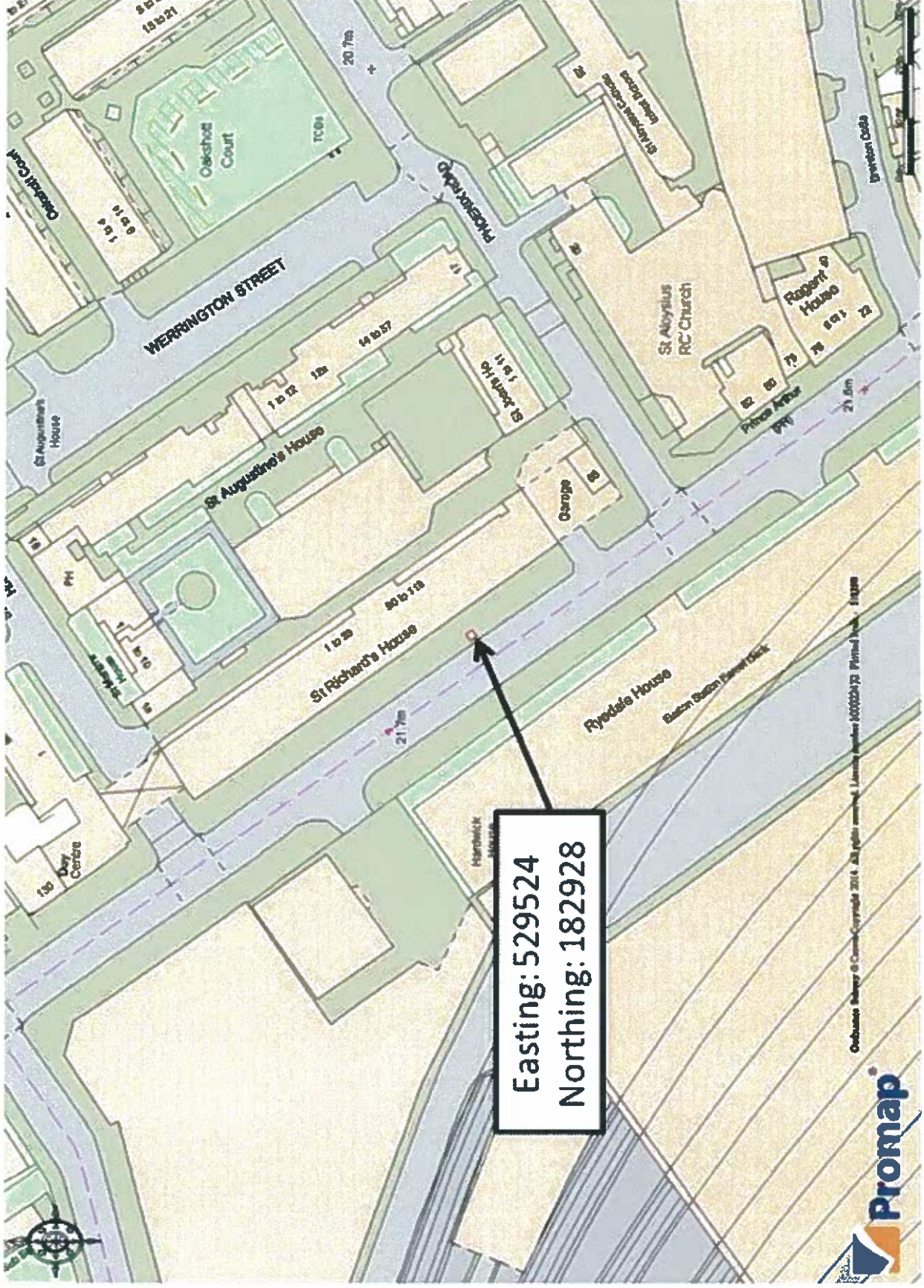

Osborne & Carter Copyright 2016. All rights reserved. Licence number: 00002373. Printed in the UK. Emap



Infocus Public Networks Ltd

# Solar Powered Telephone Kiosk (with wheelchair access)

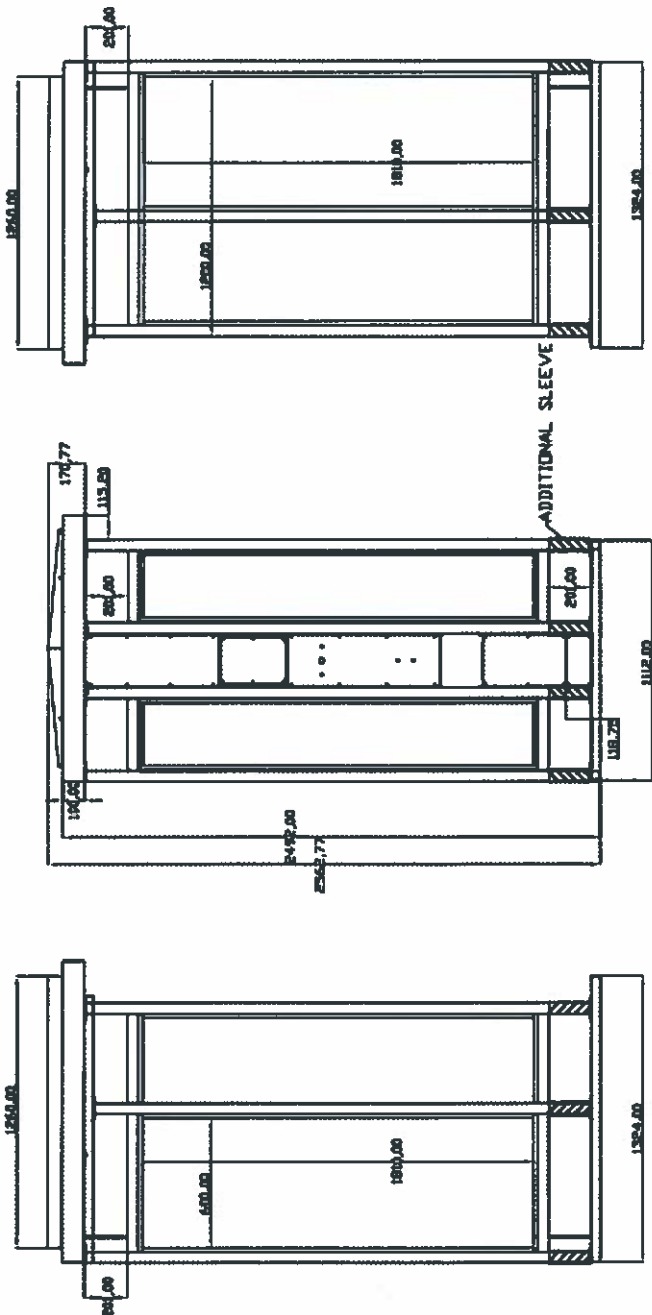
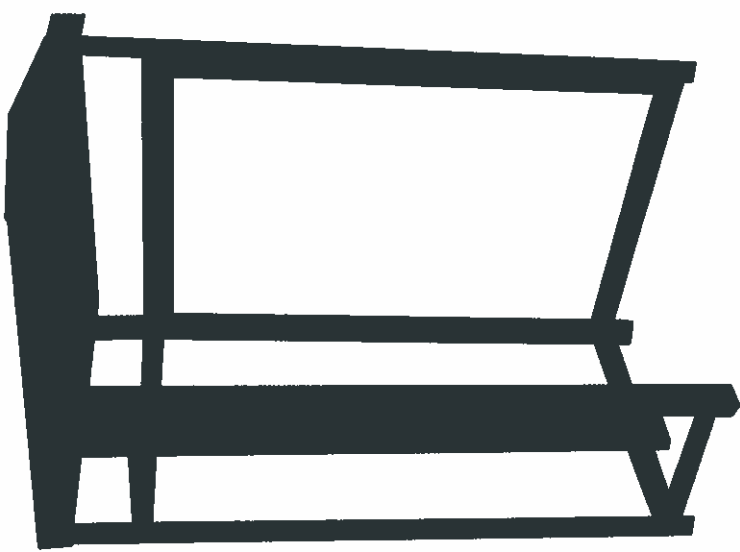

RIGHT SIDE VIEW

FRONT VIEW

LEFT SIDE VIEW

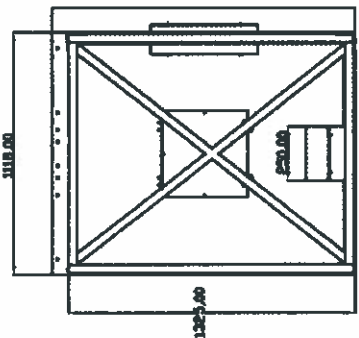

BOTTOM VIEW

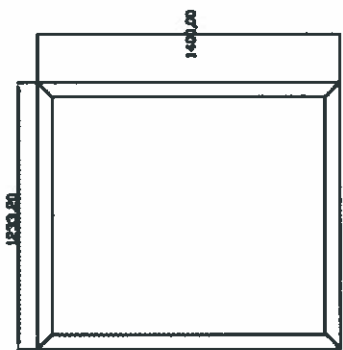

TOP VIEW

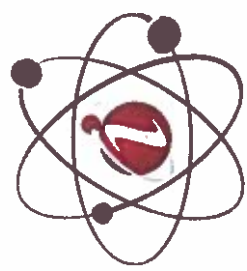

Infocus Public Networks

- Steel Frame
- Colour Pillar Black
- Clear Polycarbonate
- Toughened Glass 8mm