

Front Elevation

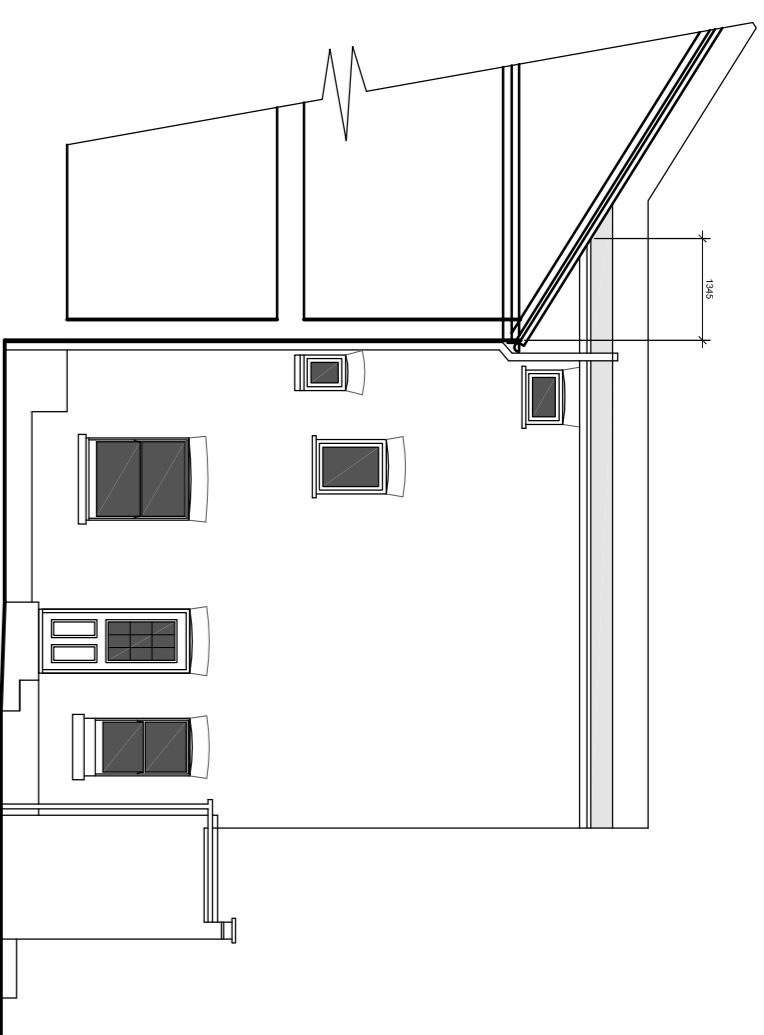

Side Elevation

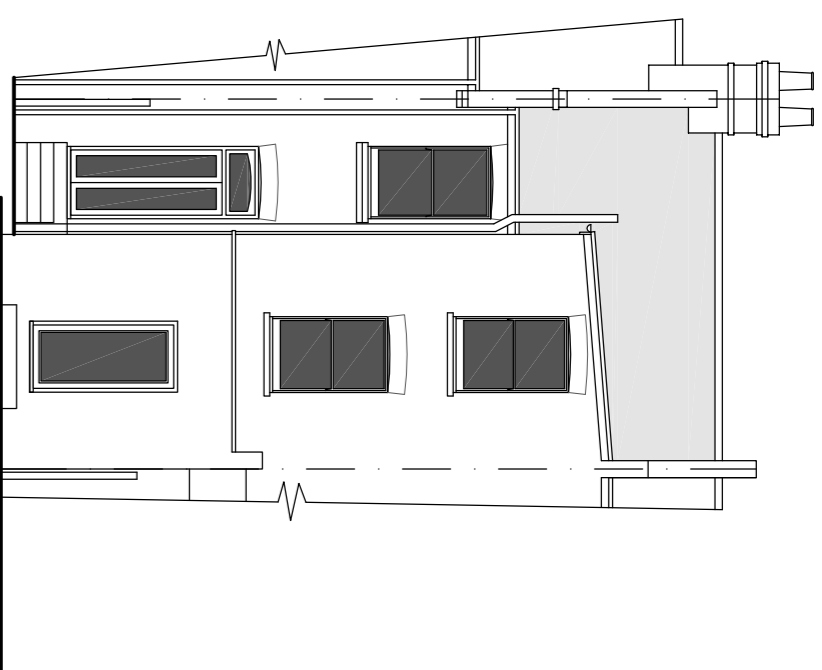

Rear Elevation

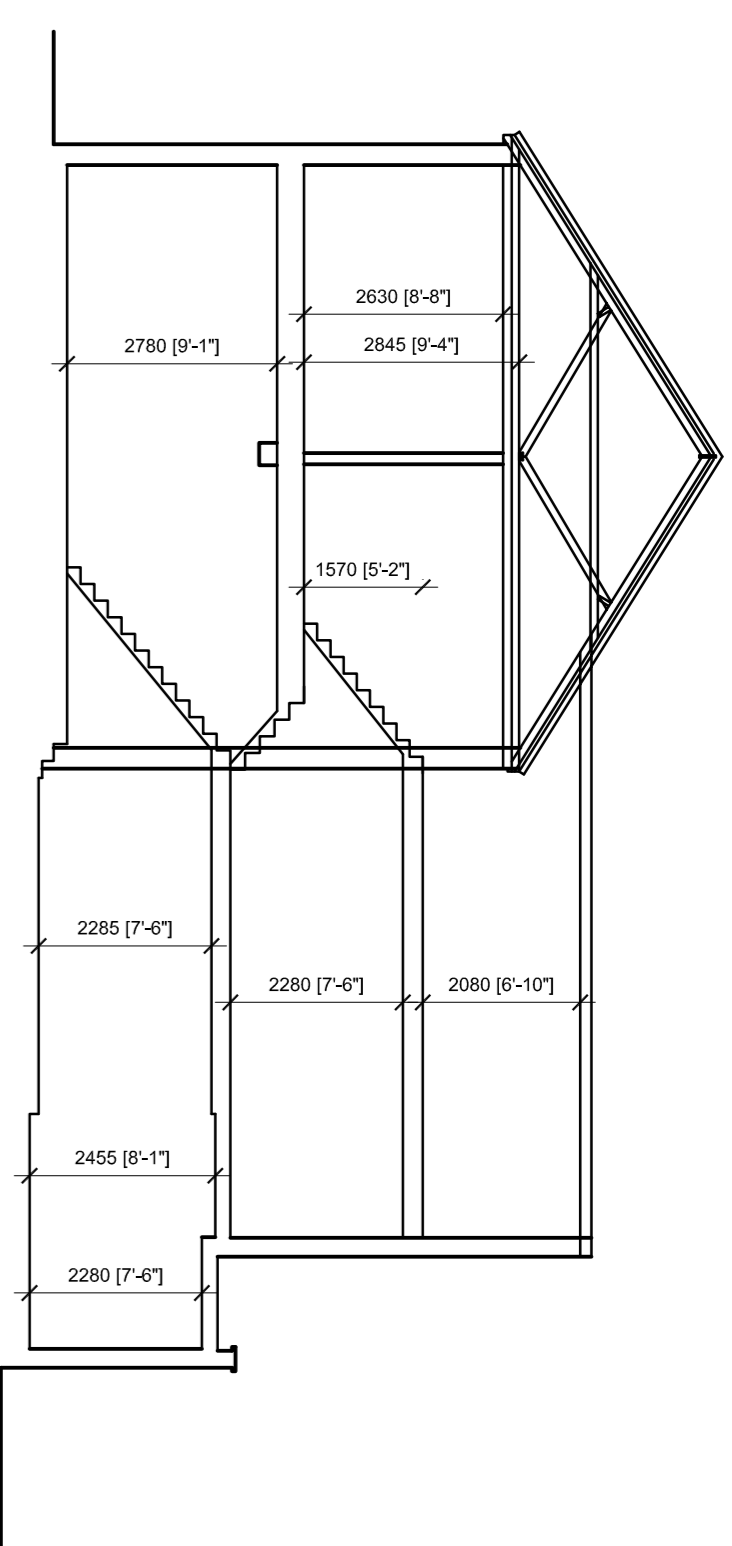

Section



Location Plan 1:1250

Site Plan 1:500

1:2500	150m
1:1250	75m
1:500	37.5m
1:250	18.75m
1:100	7.5m
1:50	3.75m

notes:
any discrepancies should be reported immediately
all dimensions should be checked on site prior to commencement of work
site/survey based on entrance survey
information provided by project systems please check on site as no guarantee that all past or current uses or features will be identified in the product
the product does not give details about the actual state or condition of the site nor should it be used or taken to indicate or exclude actual suitability or unsuitability of the site for any particular purpose, or used as a substitute for any physical investigation or inspection.
drawings to be read in accordance with the drawing emission rate (dermat) calculation, the building must be built as designed meeting the criteria set for all permeability.
© HERTFORD PLANNING SERVICE
note
when printing of pdf's
it is the responsibility of the user to verify that the resulting prints are to scale on the appropriate sized sheet.
also that the scale bars on the plan measure correctly.

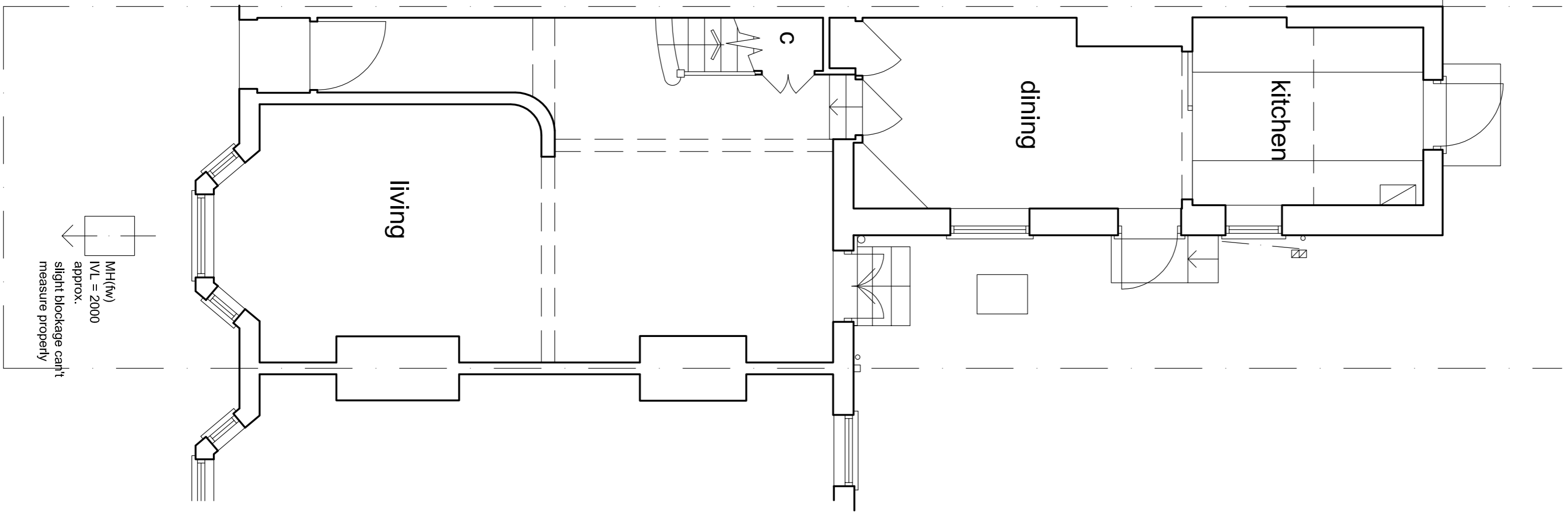

Ground Floor Plan

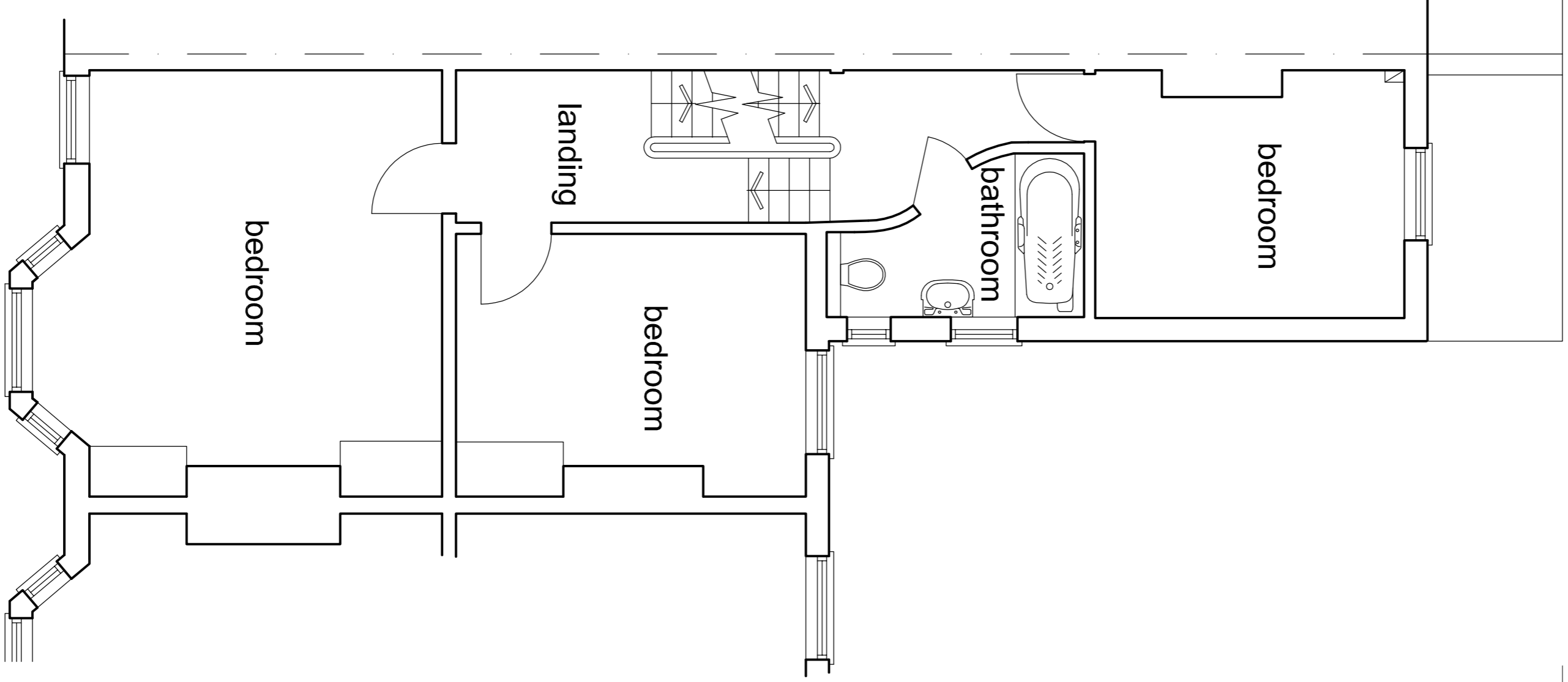

First Floor Plan

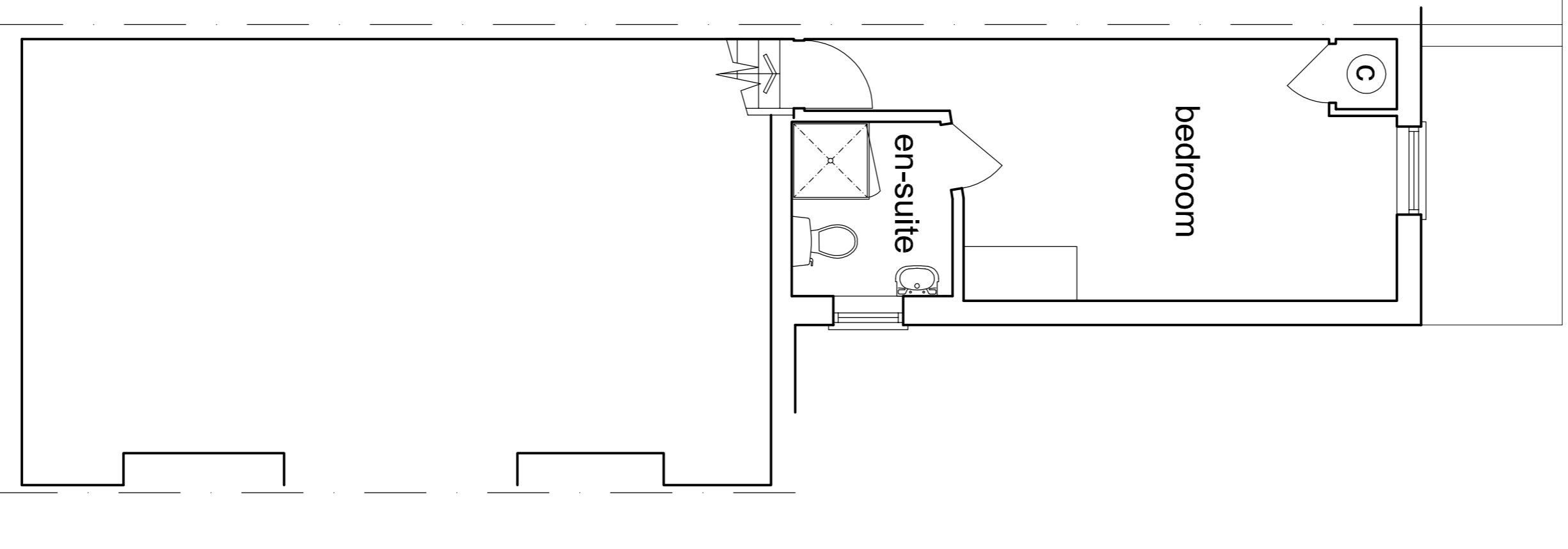

Second Floor Plan

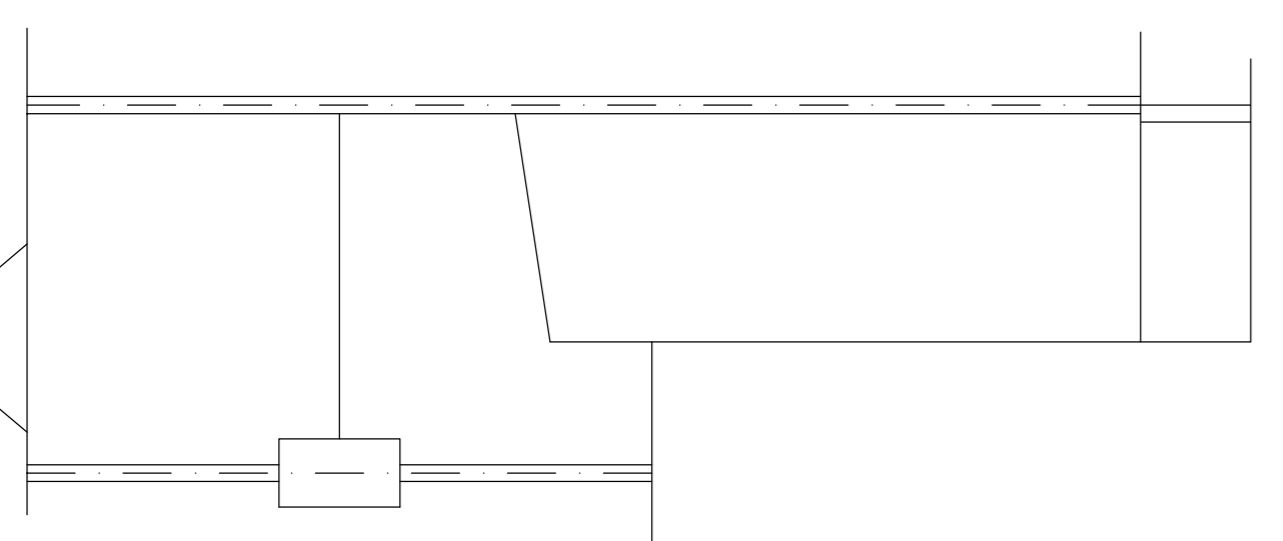

Roof Plan

1:2500	0	20m
1:1250	0	10m
1:500	0	5m
1:250	0	2.5m
1:100	0	1.25m
1:50	0	0.625m

Hertford Planning Service Architecture & Planning	
Westgate House, 37-41 Castle Street, Hertford, Herts SG14 1HH Tel: 01992 552173 Fax: 01992 587643 Email: contact@hertfordplanning.co.uk www.hertfordplanning.co.uk	
Client	Mrs K J Everett
Description Survey	10 Burrard Road
Project	London
	NW6 1DB
Drawing	EXISTING Plans & Elevations
Date	November 2013
Scale	1:100- 1:50
Sheet size	A1
Drawn	GPS
	11468-S001