

Notes
 Copyright remains the property of Canaway Fleming Architects and this drawing is not to be used for any purposes without the express permission of the Architect. No implied License is given for its use.

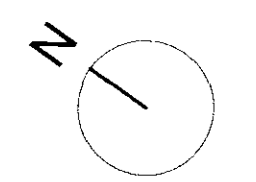

Do not scale from this drawing. All dimensions should be checked on site for accuracy.

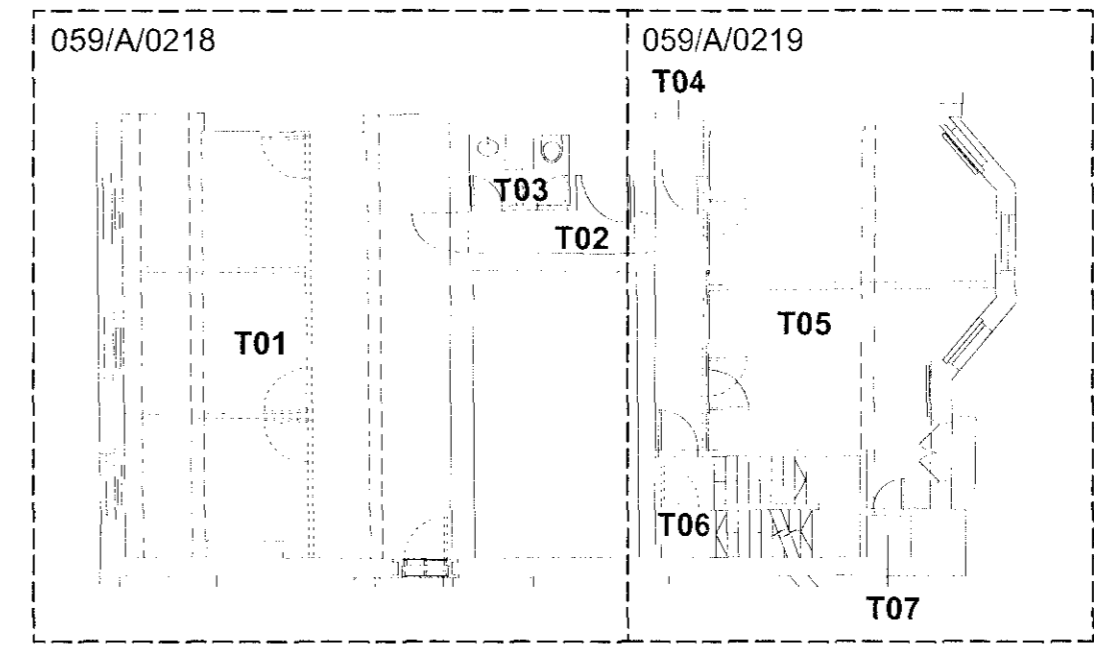

NO.43 THIRD FLOOR REFERENCE PLAN

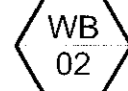
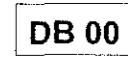
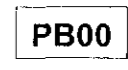

KEY:

-  Window reference: (Level:No)
-  Door reference: (Level:No)
-  Photographic record reference
-  Proposed works reference. Refer to schedule of works

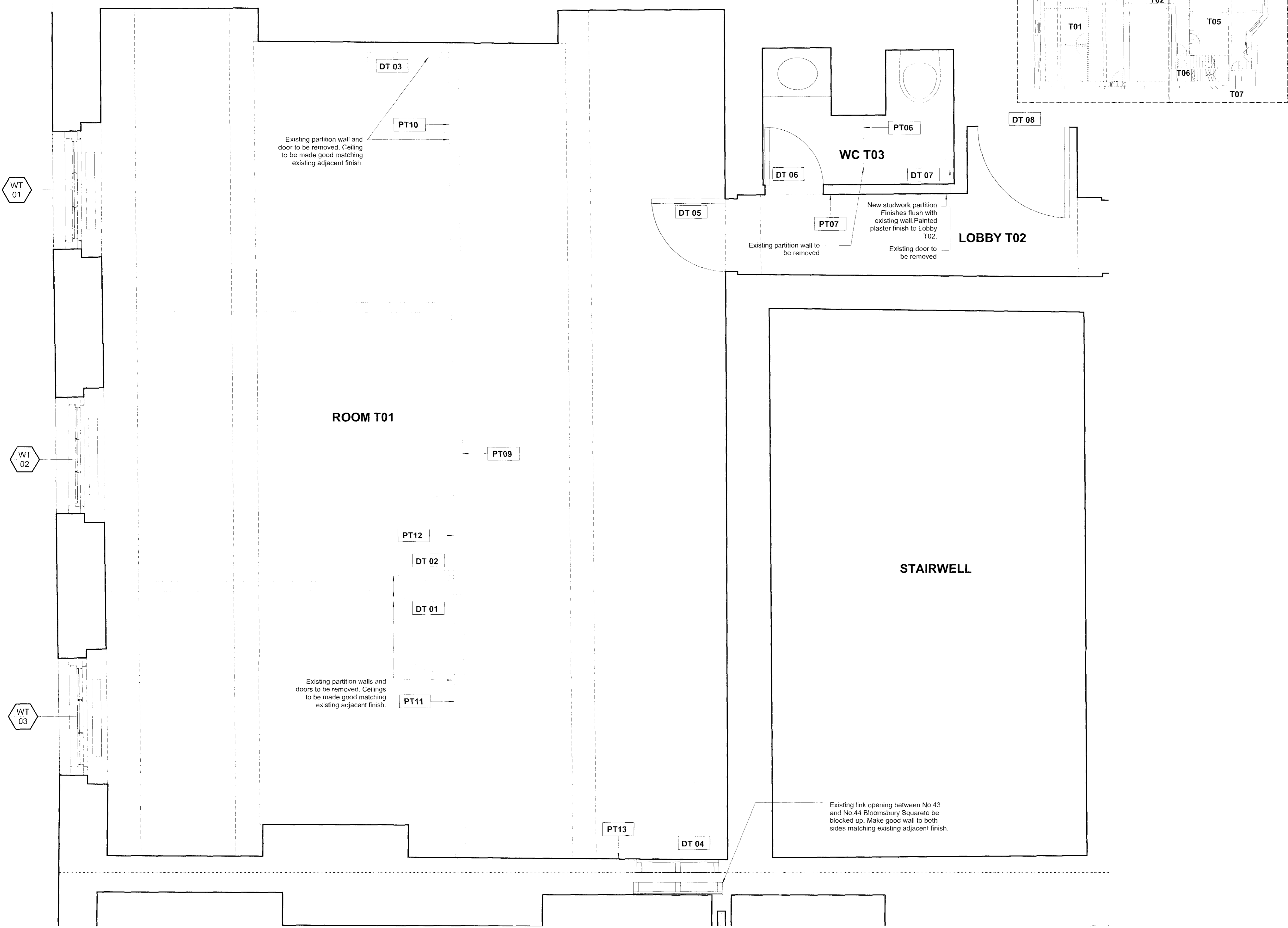

Revisions

CANAWAY FLEMING ARCHITECTS

Canaway Fleming Architects Ltd
 The Dutch House
 307-308 High Holborn
 London WC1V 7LL
 T: 020 7430 2262
 F: 020 7430 2274
 E: mailbox@canawayfleming.com

Client: Holborn Links Limited.

Project: 43-45 Bloomsbury Square.

Drawing Title: No.43 Proposed Third Floor Sheet 1 of 2

Date: May 2010 Scale: 1:20 @ A1

© Copyright Canaway Fleming Architects Ltd

Project	Origin	No.	Revision
059	A	0218	-
Status	Drawn	Checked	
PLANNING	LH	MC	



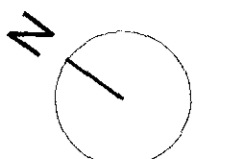



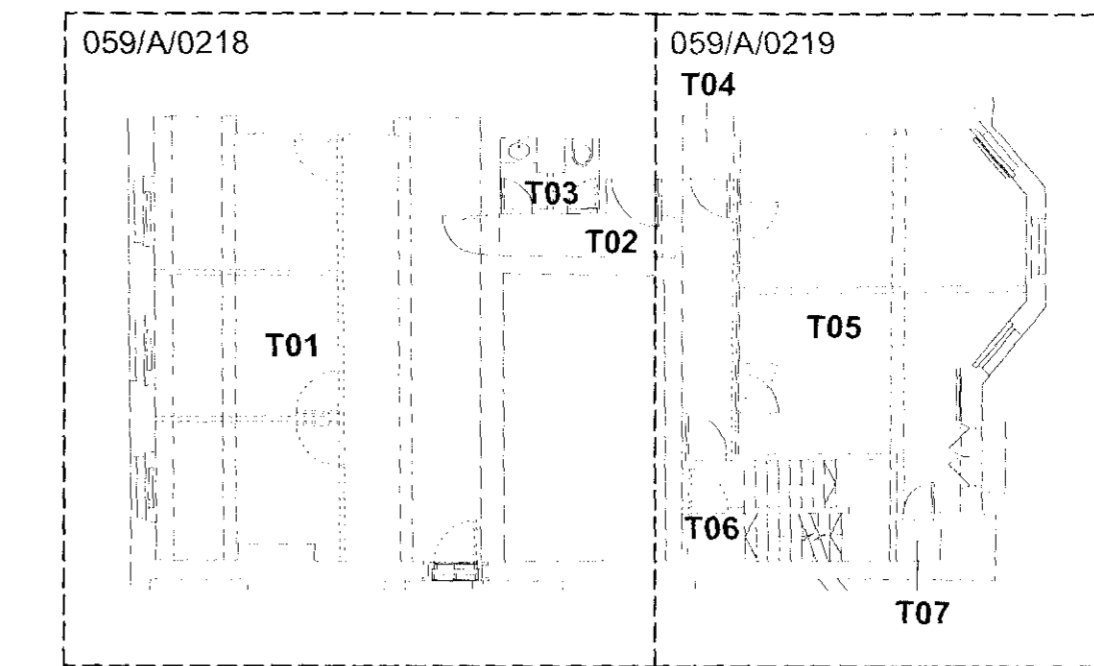

NO.43 THIRD FLOOR REFERENCE PLAN



KEY:

-  Window reference: (Level:No)
-  Door reference: (Level:No)
-  Photographic record reference
-  Proposed works reference. Refer to schedule of works

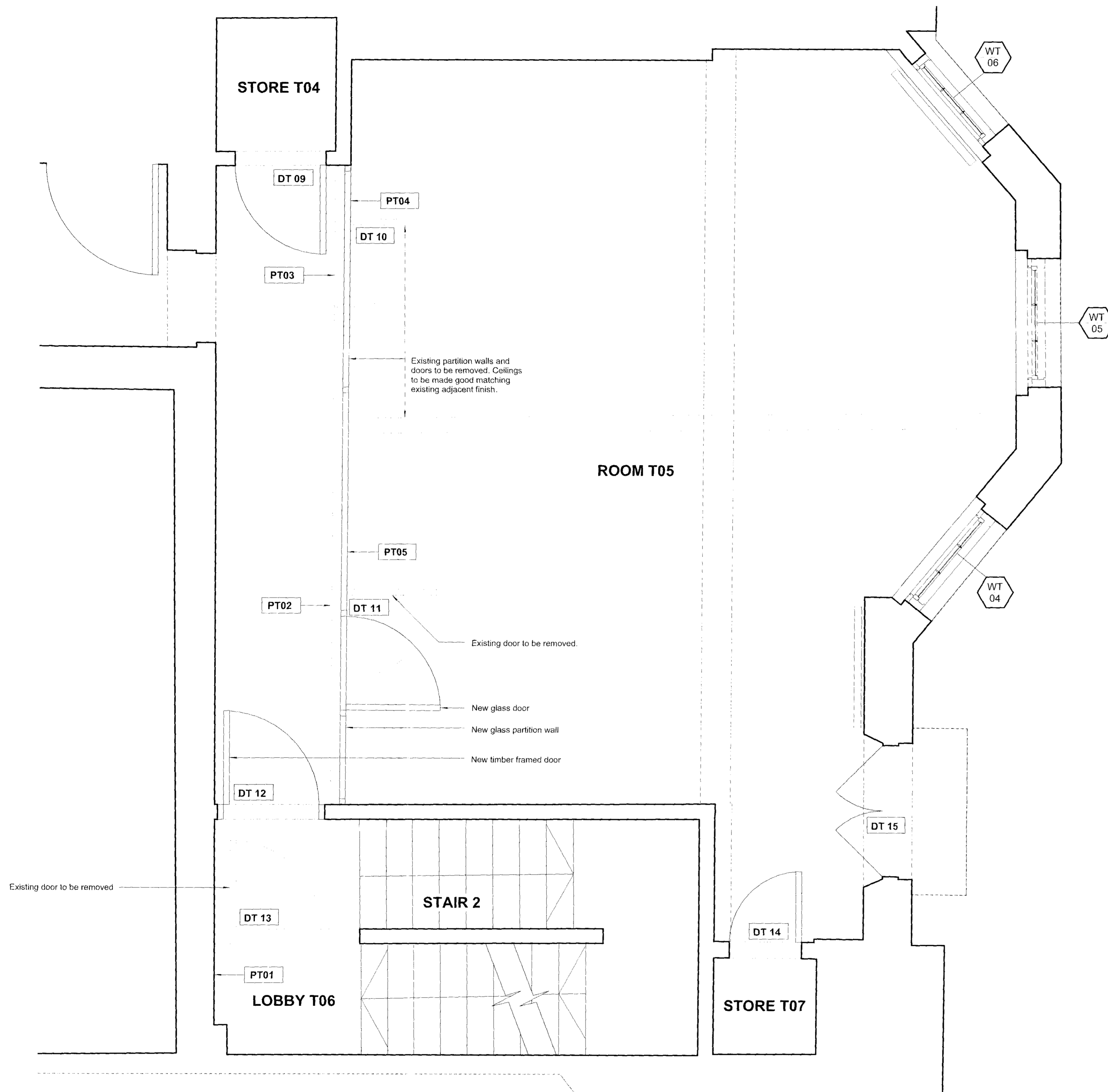

Revisions

CANAWAY FLEMING ARCHITECTS

Canaway Fleming Architects Ltd
The Dutch House
307-308 High Holborn
London WC1V 7LL
T: 020 7430 2262
F: 020 7430 2274
E: mailbox@canawayfleming.com

Client: Holborn Links Limited.

Project: 43-45 Bloomsbury Square.

Drawing Title: No.43 Proposed Third Floor
2 of 2

Date: May 2010 Scale: 1:20 @ A1

© Copyright Canaway Fleming Architects Ltd.

Project	Origin	No.	Revision
059	A	0219	-
Status	Drawn	Checked	
PLANNING	LH	MC	

