

Project	ref. Wanting/Low 10105	OUTSIDE VIEW	
Order	Z2400724	Quantity	1
ITEM	1 - BAY1 - GF	Drawn by	PP
Profile	SS C&W 150	Date	17.02.2025

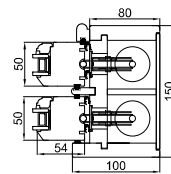

Project	ref. Wanting/Low 10105	OUTSIDE VIEW	
Order	Z2400724	Quantity	1
ITEM	2 - BAY2 - GF	Drawn by	PP
Profile	SS C&W 150	Date	17.02.2025

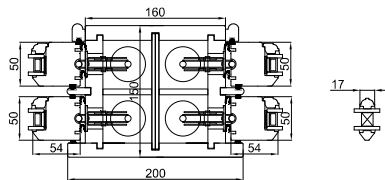
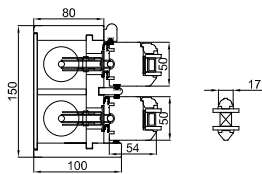
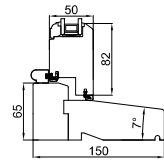
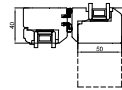
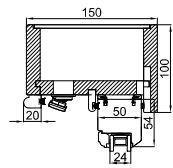
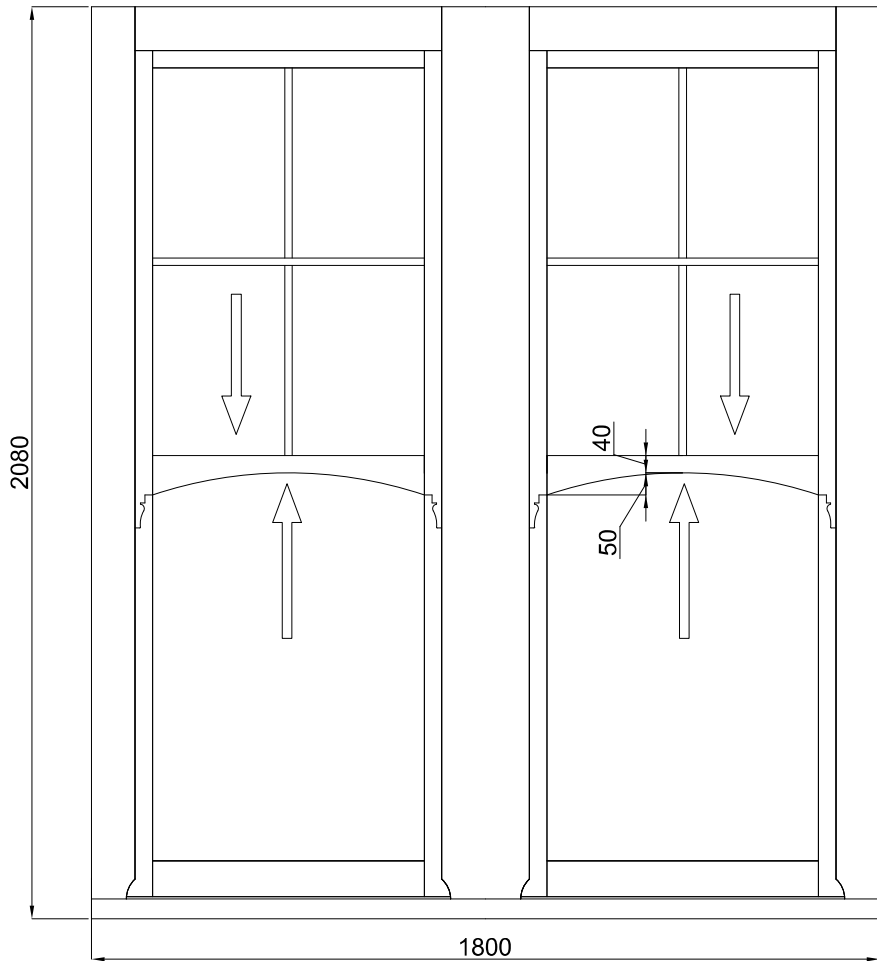
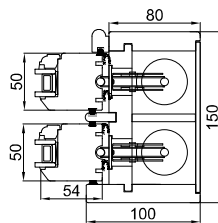
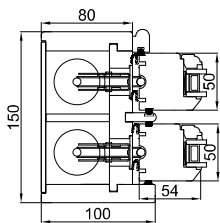
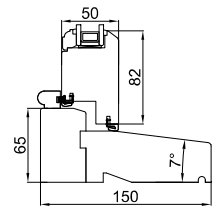
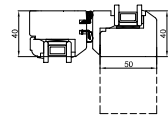
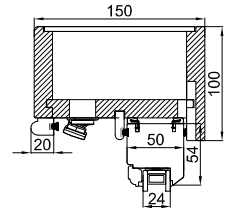
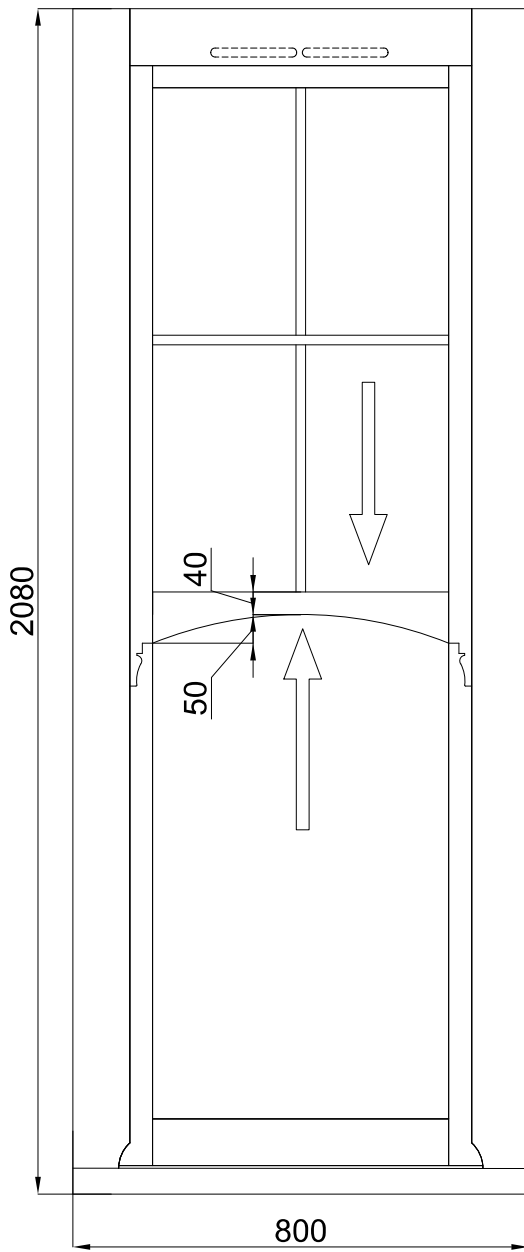

Project	ref. Wanting/Low 10105	OUTSIDE VIEW	
Order	Z2400724	Quantity	1
ITEM	3 - BAY1 - GF	Drawn by	PP
Profile	SS C&W 150	Date	17.02.2025

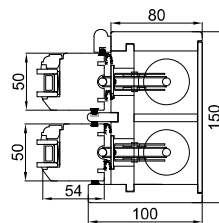
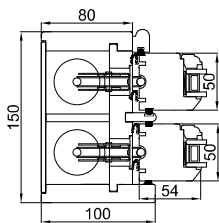
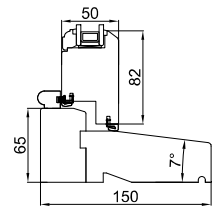
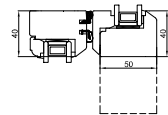
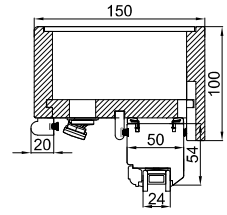
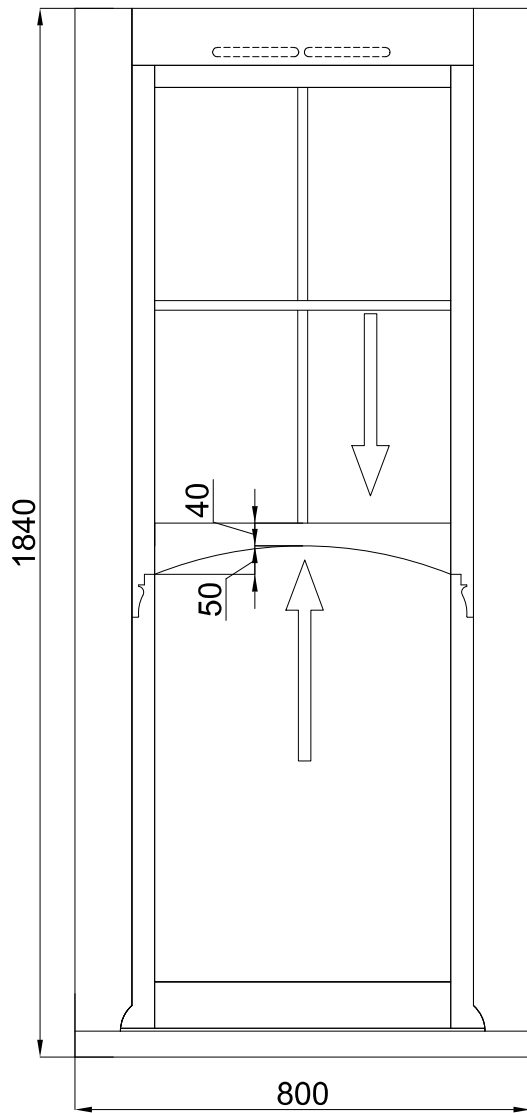

Project	ref. Wanting/Low 10105	OUTSIDE VIEW	
Order	Z2400724	Quantity	1
ITEM	5 - BAY1 - FF	Drawn by	PP
Profile	SS C&W 150	Date	17.02.2025

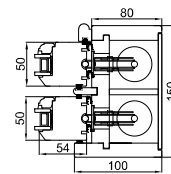
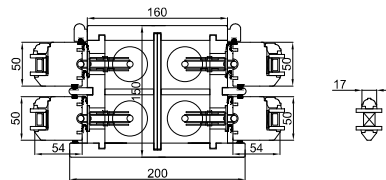
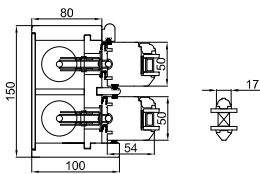
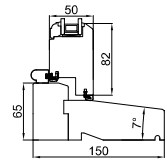
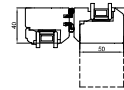
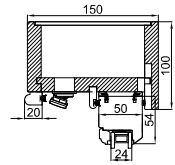
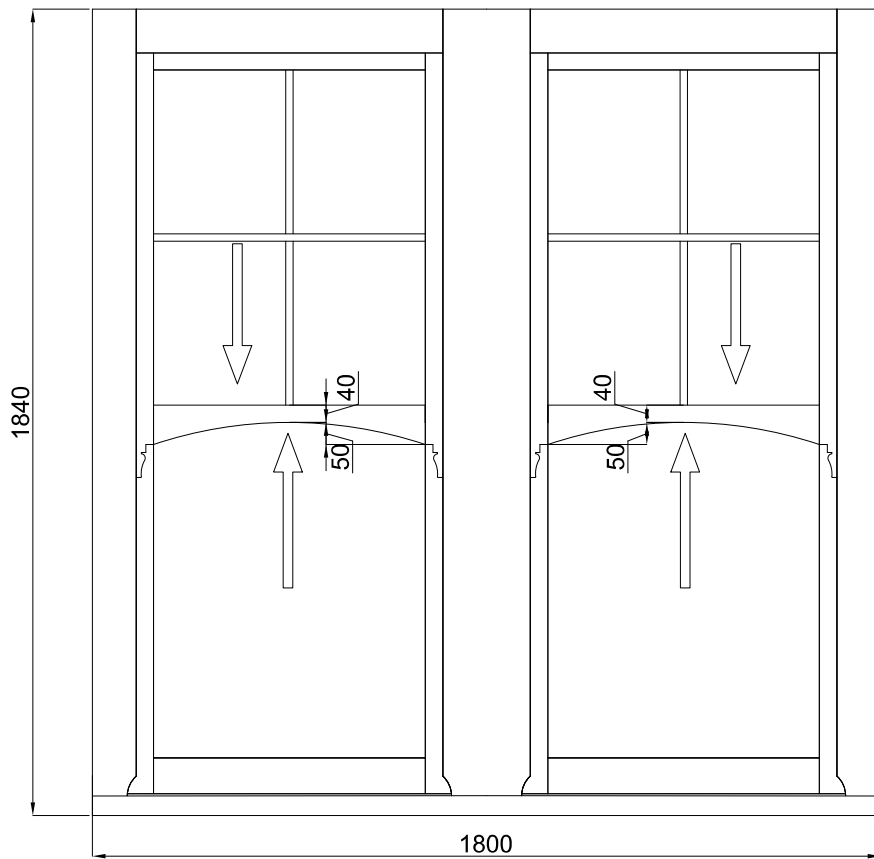

Project	ref. Wanting/Low 10105	OUTSIDE VIEW	
Order	Z2400724	Quantity	1
ITEM	6 - BAY2 - FF	Drawn by	PP
Profile	SS C&W 150	Date	17.02.2025

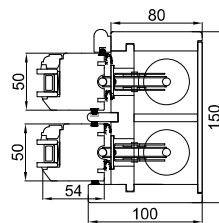
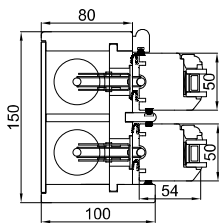
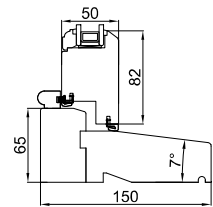
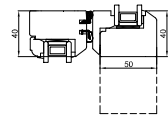
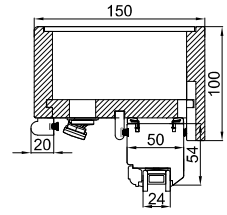
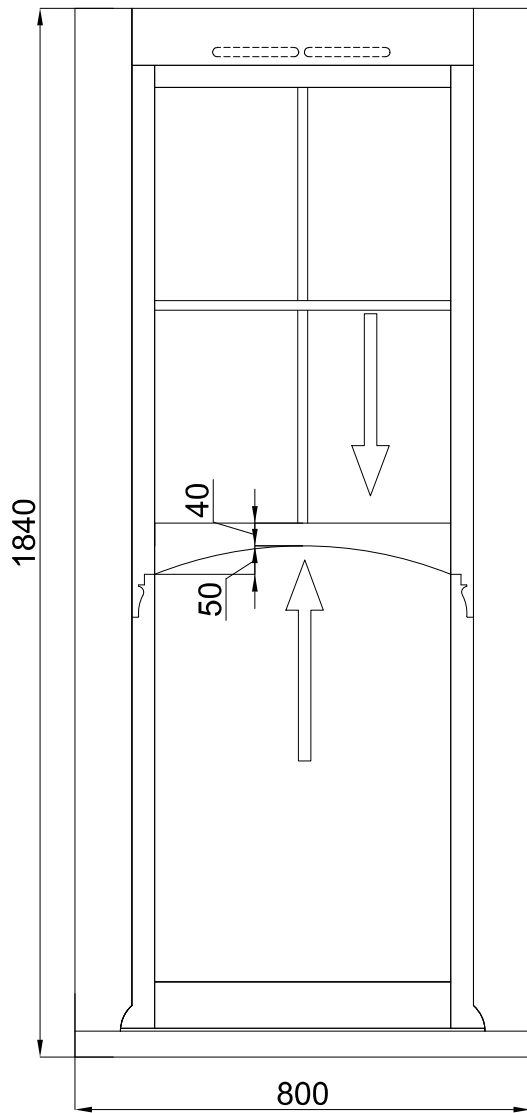

Project	ref. Wanting/Low 10105	OUTSIDE VIEW	
Order	Z2400724	Quantity	1
ITEM	7 - BAY3 - FF	Drawn by	PP
Profile	SS C&W 150	Date	17.02.2025

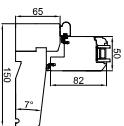
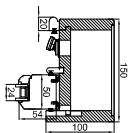
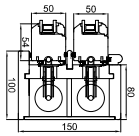
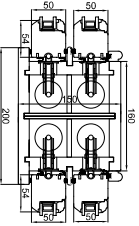
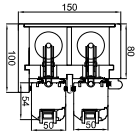
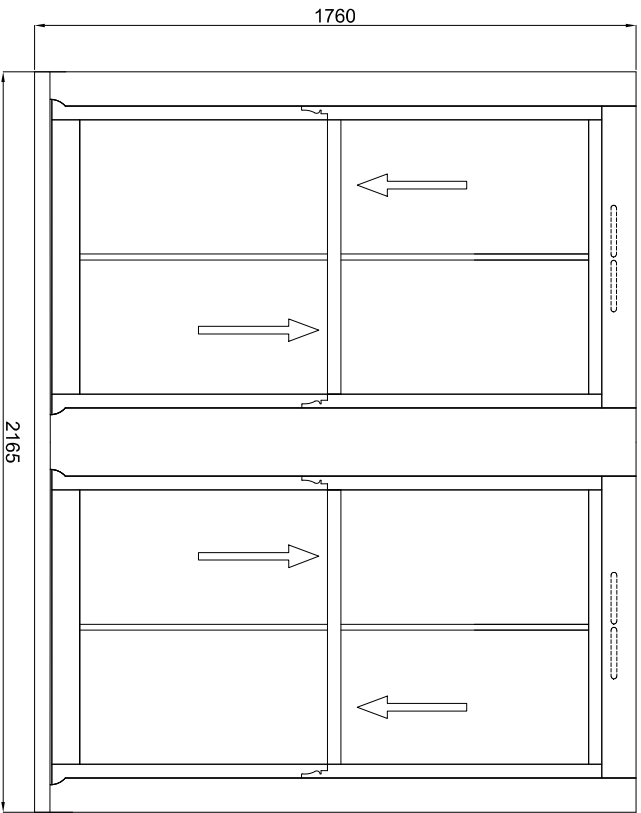

Project	ref. Wanting/Low 10105	OUTSIDE VIEW
Order	Z2400724	Quantity 1
ITEM	8 - FF BED REAR	Technologist PP
Profile	SS C&W 150/50	Data 17.02.2025

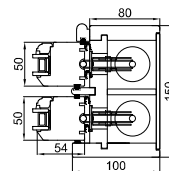
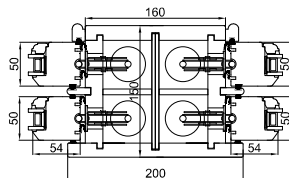
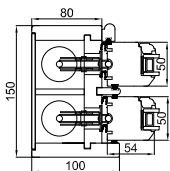
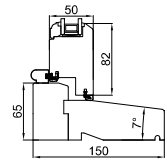
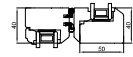
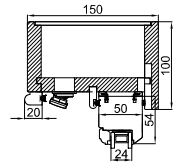
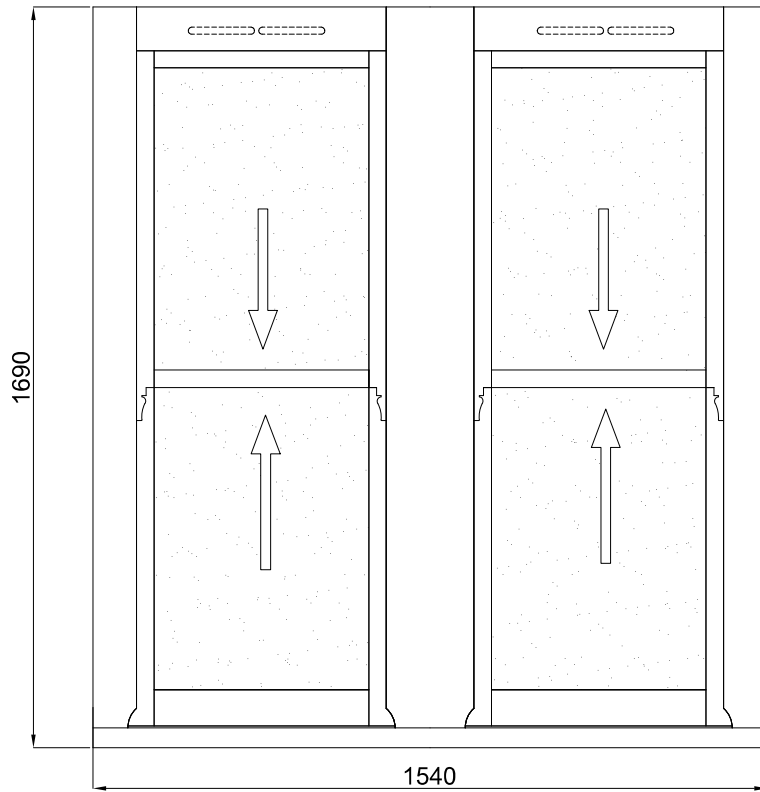

Project	ref. Wanting/Low 10105	OUTSIDE VIEW	
Order	Z2400724	Quantity	1
ITEM	6 - BAY2 - FF	Drawn by	PP
Profile	SS C&W 150	Date	17.02.2025

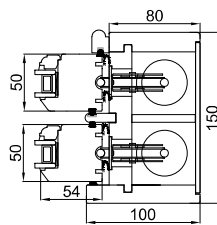
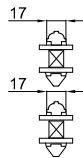
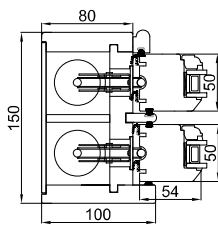
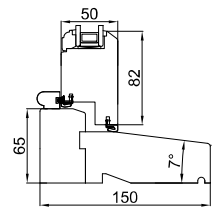
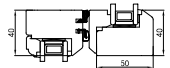
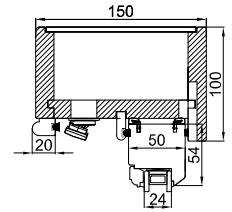
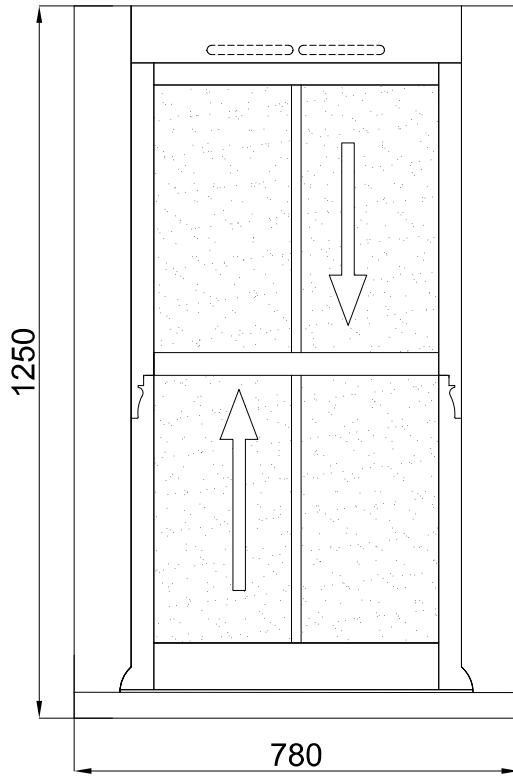

Project	ref. Wanting/Low 10105	OUTSIDE VIEW	
Order	Z2400724	Quantity	1
ITEM	10 - FF WC (small)	Drawn by	PP
Profile	SS C&W 150	Date	17.02.2025

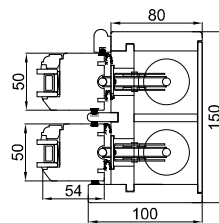
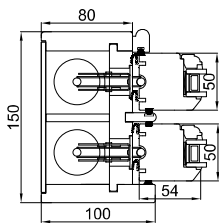
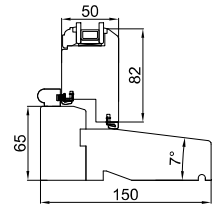
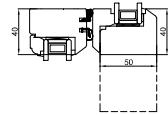
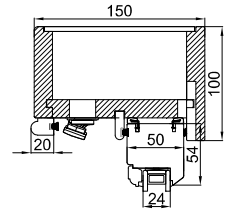
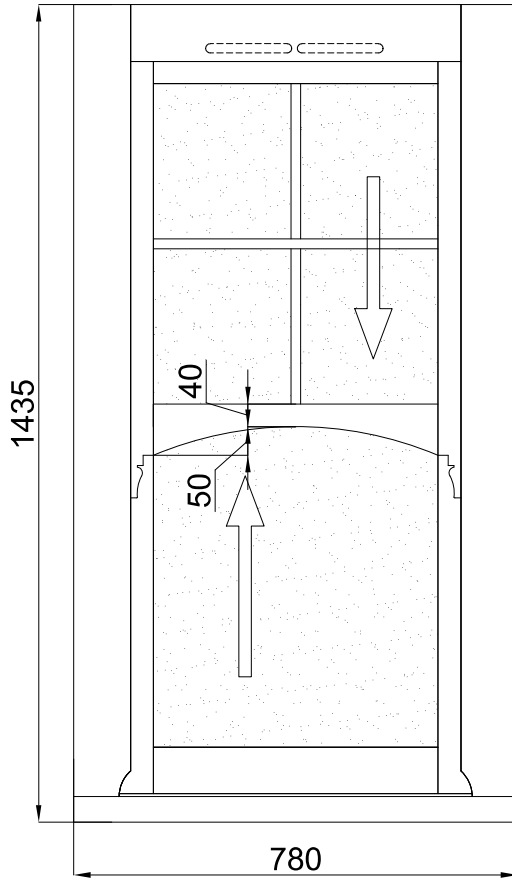

Project	ref. Wanting/Low 10105	OUTSIDE VIEW	
Order	Z2400724	Quantity	1
ITEM	11 - FF BATHROOM (FRONT)	Drawn by	PP
Profile	SS C&W 150	Date	17.02.2025

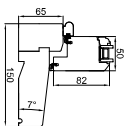
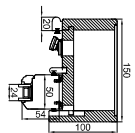
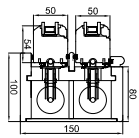
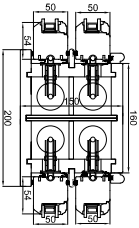
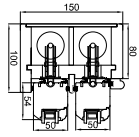
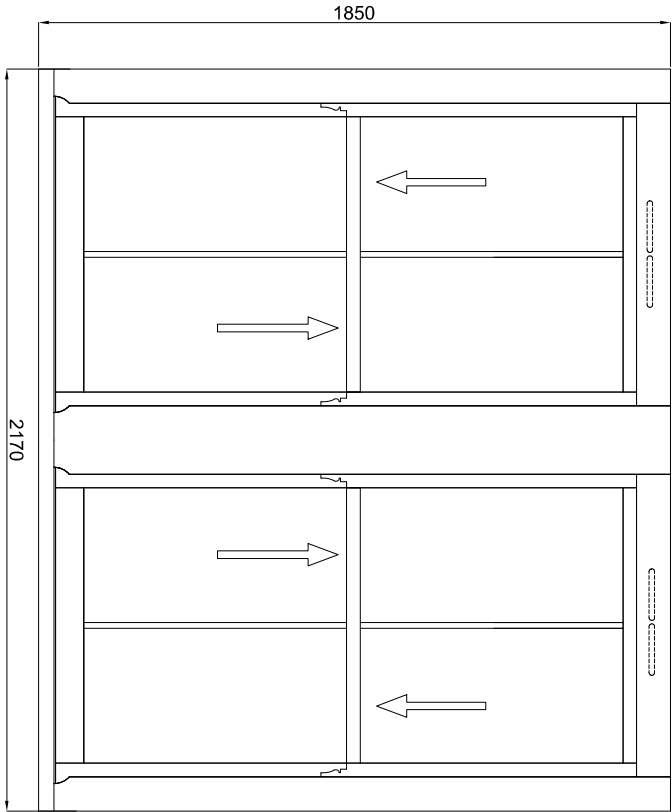

Project	ref. Wanting/Low 10105	OUTSIDE VIEW
Order	Z2400724	Quantity 1
ITEM	12 - 2F BED (REAR)	Technologist PP
Profile	SS C&W 150/50	Data 17.02.2025

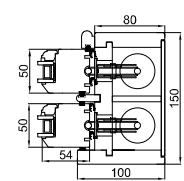
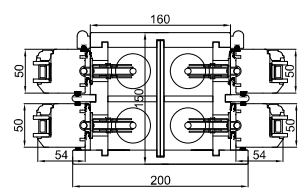
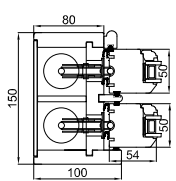
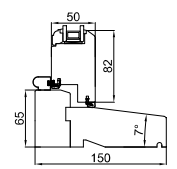
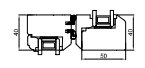
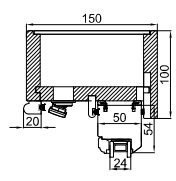
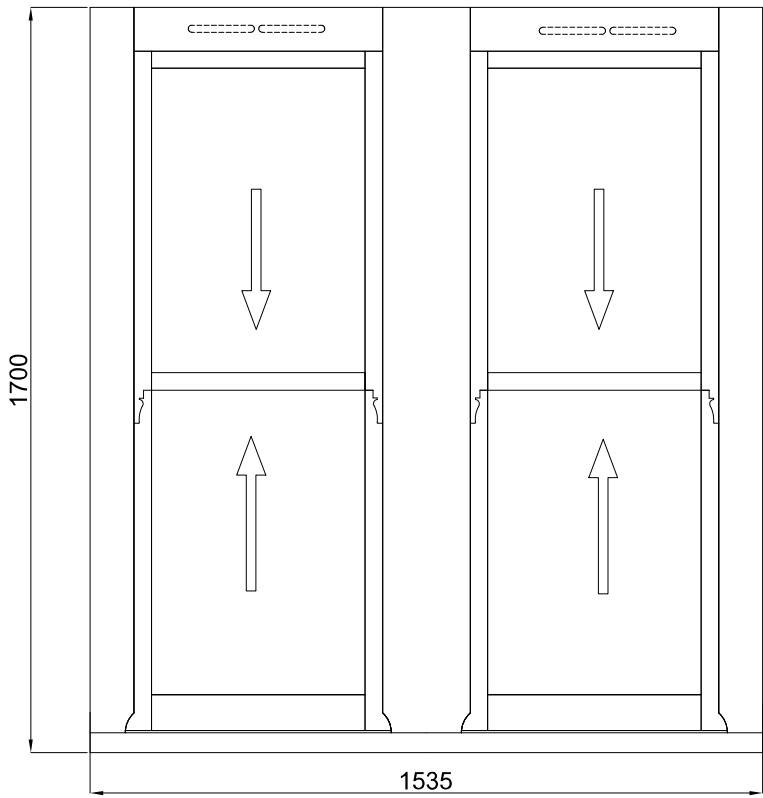

Project	ref. Wanting/Low 10105	OUTSIDE VIEW	
Order	Z2400724	Quantity	1
ITEM	13 - 2F BED (REAR2)	Drawn by	PP
Profile	SS C&W 150	Date	17.02.2025

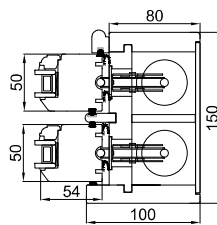
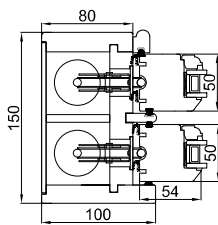
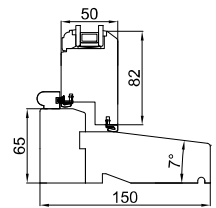
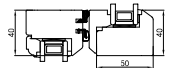
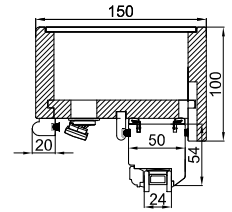
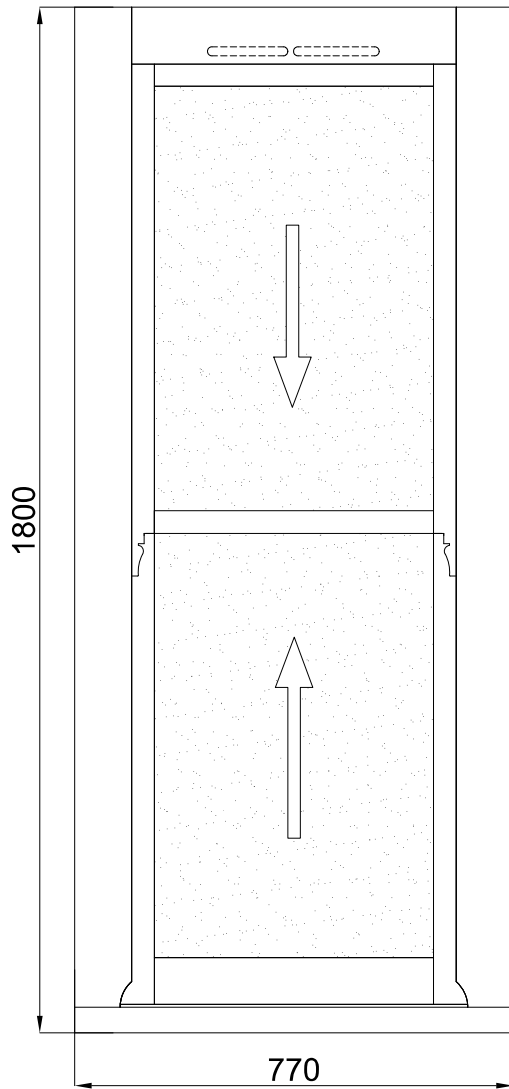

Project	ref. Wanting/Low 10105	OUTSIDE VIEW	
Order	Z2400724	Quantity	1
ITEM	14 - 2ND FLOOR BATHROOM	Drawn by	PP
Profile	SS C&W 150	Date	17.02.2025

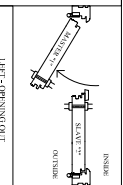
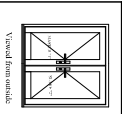
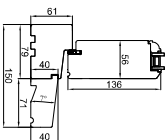
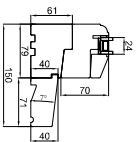
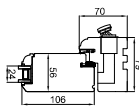
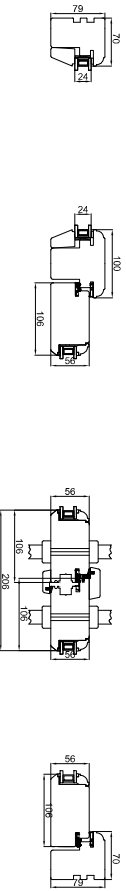
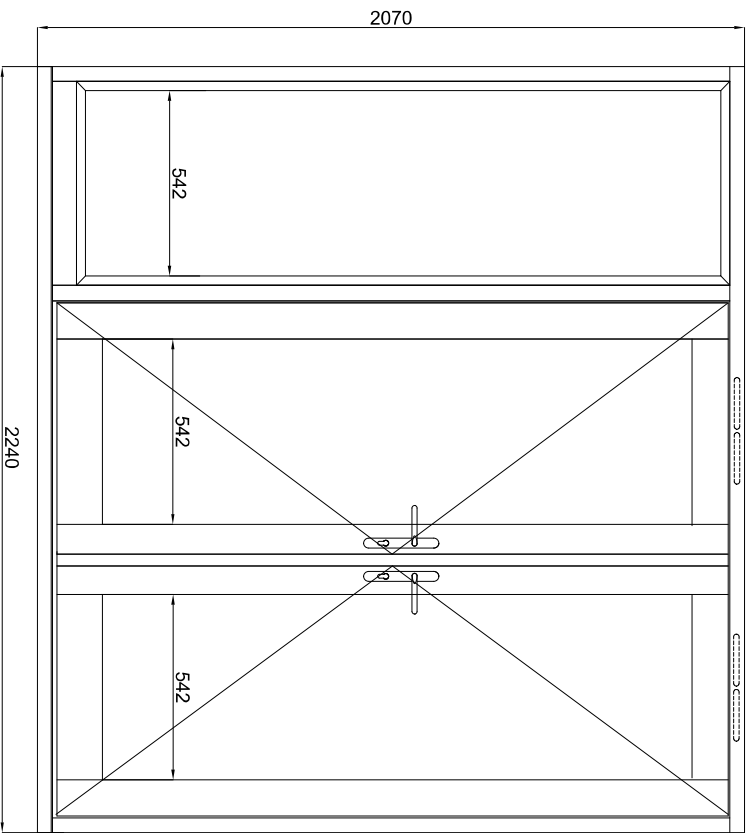

Project	ref. Wanting/Low 10105	OUTSIDE VIEW
Order	Z2400724	Quantity 1
ITEM	15 - French door	Technologist PP
Profile	Flush Door OUT	Data 17.02.2025

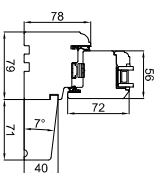
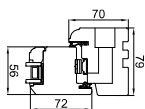
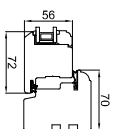
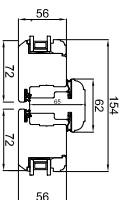
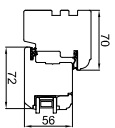
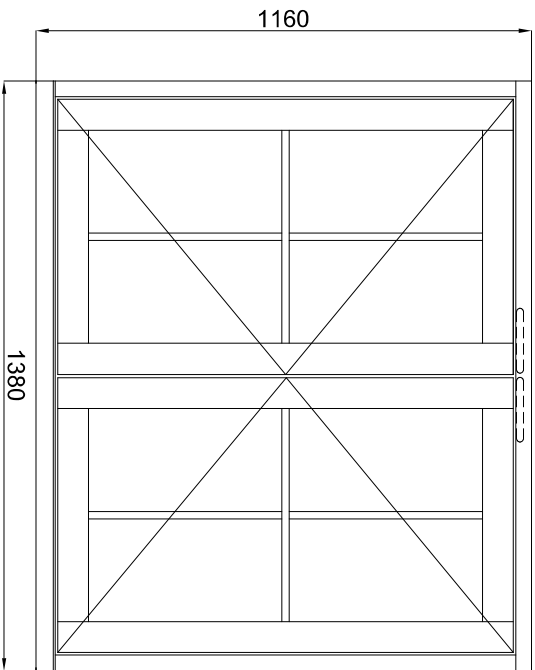

Project	ref. Wanting/Low 10105	OUTSIDE VIEW
Order	Z2400724	Quantity 1
ITEM	16 - Facet A1	Technologist PP
Profile	CAS SW56	Data 17.02.2025

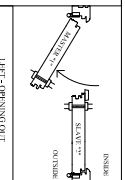
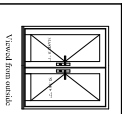
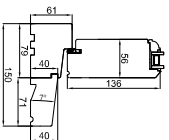
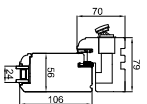
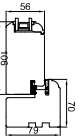
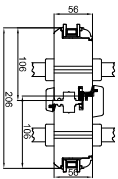
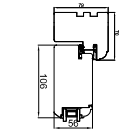
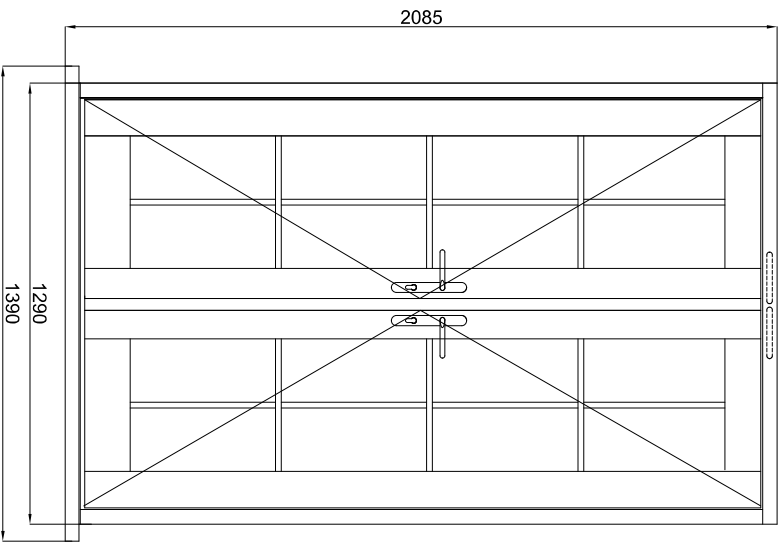

Project	ref. Wanting/Low 10105	OUTSIDE VIEW
Order	Z2400724	Quantity 1
ITEM	17 - Facet B1	Technologist PP
Profile	Flush Door OUT	Data 17.02.2025

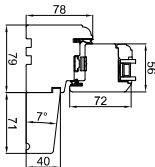
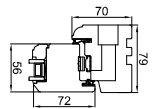
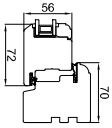
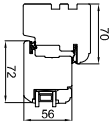
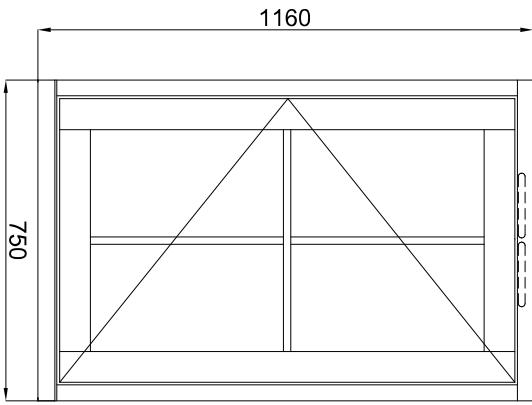

Project	ref. Wanting/Low 10105	OUTSIDE VIEW	
Order	Z2400724	Quantity	1
ITEM	18 - Facet C1	Technologist	PP
Profile	CAS SW56	Data	17.02.2025

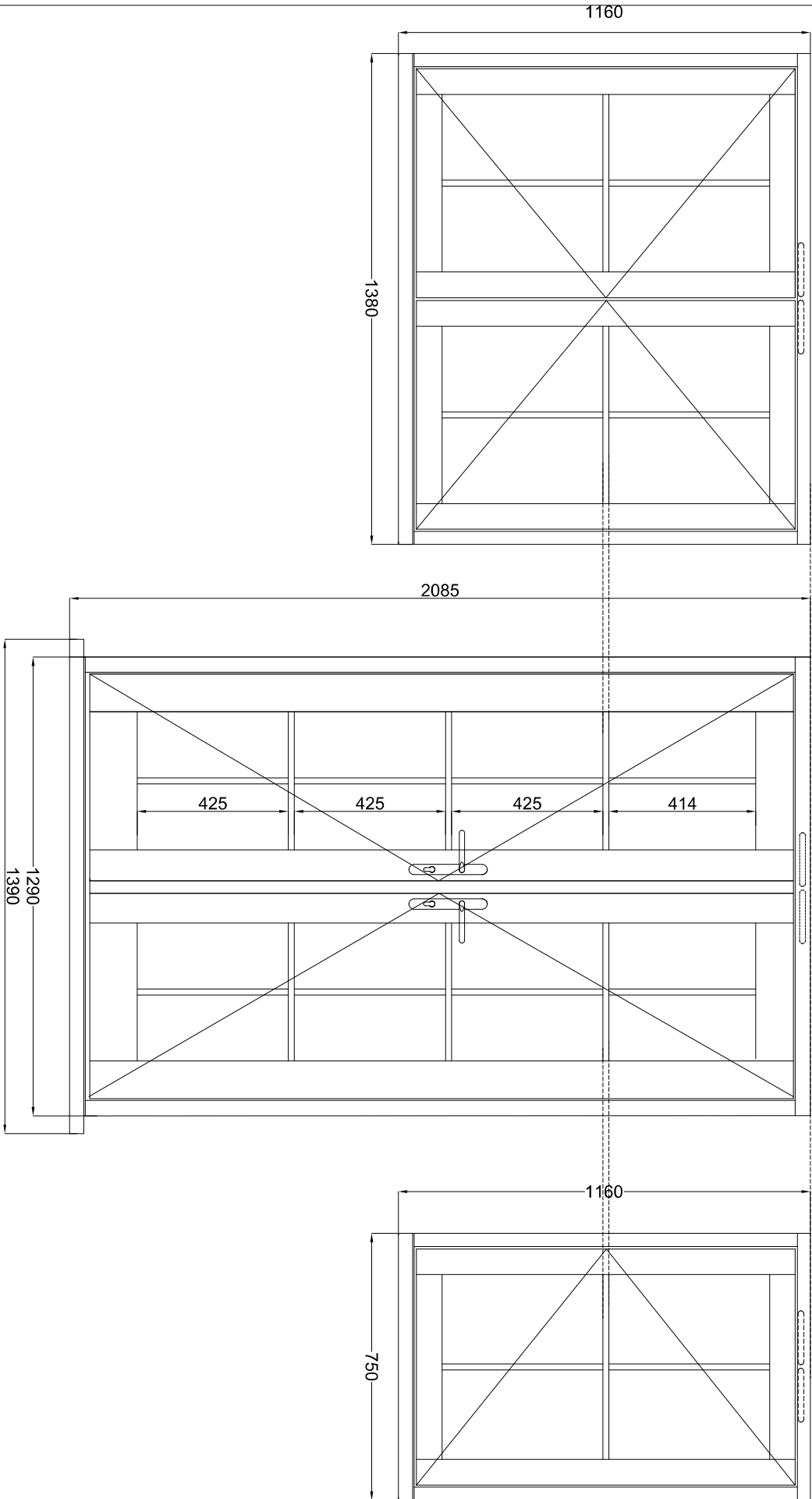

Project	ref. Wanting/Low 10105	OUTSIDE VIEW
Order	Z2400724	Quantity 1
ITEM	16.17.18	Technologist PP
Profile	Flush Door OUT	Data 17.02.2025