

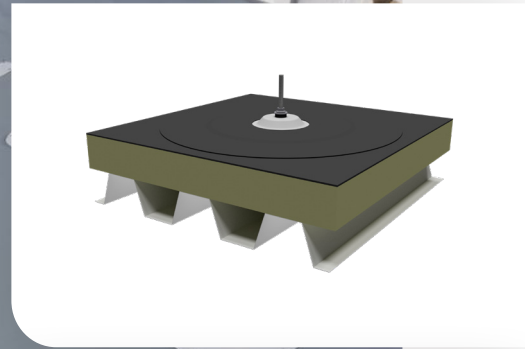





Installation manual











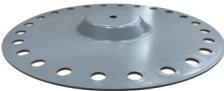

ValkSolarFix

Mounting in steel sheet roof with screws
for flat and pitched roofs

Installation manual ValkSolarFix / Mounting in steel sheet roof with screws

Needed tools			
Wrench 15 + 17		Drill	
Fixation tool 15 L=200 mm		Torx Bit TX25 25 mm	

Separate components		
Article number	Description	
747600	ValkSolarFix Low h=20mm	
747601	ValkSolarFix Low h=20mm - PVC coated* * On request only, not in stock as standard.	
747605	ValkSolarFix Low - PVC cover	
747604	ValkSolarFix - Ss. mounting set M10 + sealing ring	
747640	ValkSolarFix - Roof screws 4,8x60mm* - Steel 6x * Height from top edge of roof covering to top edge of high crown/cannalure steeldeck: max 30mm	
747641	ValkSolarFix - Roof screws 4,8x90mm* - Steel 6x * Height from top edge of roof covering to top edge of high crown/cannalure steeldeck: max 60mm	
747642	ValkSolarFix - Roof screws 4,8x140mm* - Steel 6x * Height from top edge of roof covering to top edge of high crown/cannalure steeldeck: max 110mm	
747643	ValkSolarFix - Roof screws 4,8x240mm* - Steel 6x * Height from top edge of roof covering to top edge of high crown/cannalure steeldeck: max 210mm	
747644	ValkSolarFix - Roof screws 4,8x280mm* - Steel 6x * Height from top edge of roof covering to top edge of high crown/cannalure steeldeck: max 250mm	
747645	ValkSolarFix - Roof screws 6,3x330mm* - Steel 6x * Height from top edge of roof covering to top edge of high crown/cannalure steeldeck: max 300mm	
747695	ValkSolarFix fixation tool 15 L-200mm	

1 ValkSolarFix + SS mounting set + seal

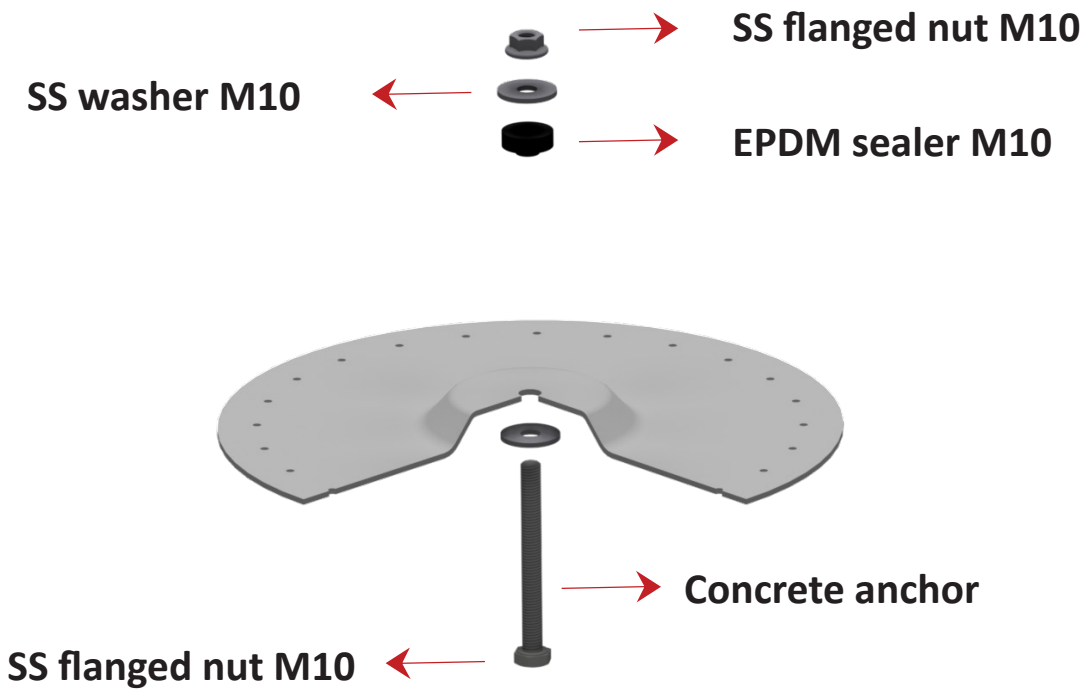

2

1 Nm
15 + 17

Detailed description: This section shows the tools required for the installation. A blue square icon contains a white wrench and a white screwdriver. Below the icon, the text '1 Nm' and '15 + 17' is displayed. This indicates that the torque should be set to 1 Nm for the 15mm and 17mm wrenches.

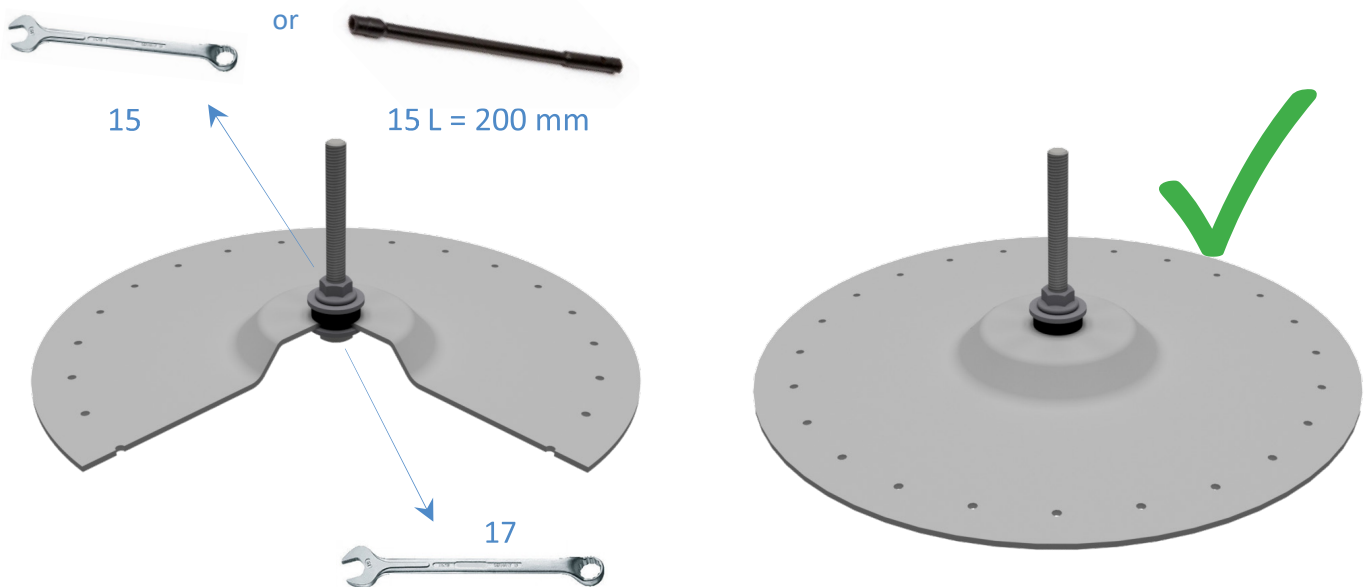

3

Thickness steel sheet:
- 0.5mm to 2.5mm
- max 2.5mm in case of double sheet / overlapping sheet



Height from top edge of roof covering to top edge of high crown/cannalure steeldeck: **max 300mm**

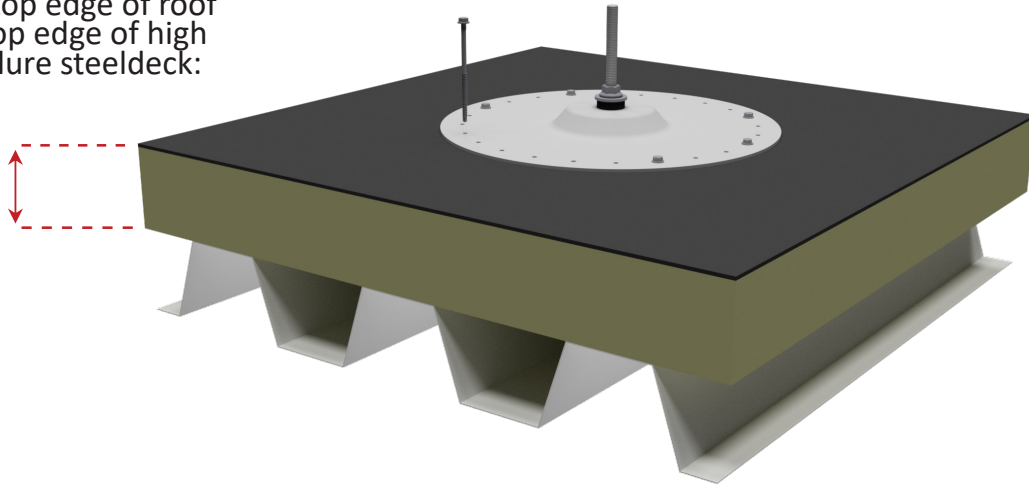

4

Needed amount of screws*
- 3 on 1 crown

Recommended pierce length*
20mm through steel roof sheet

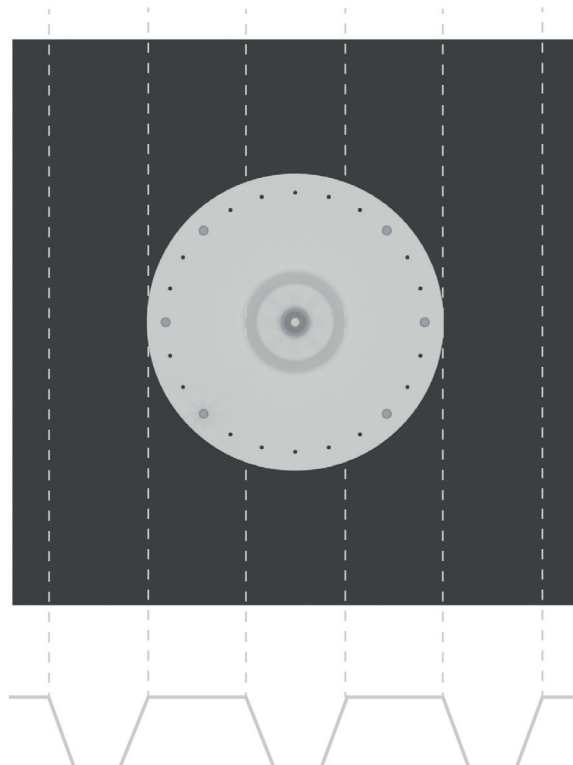
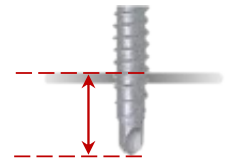

* See type of screws at the first page of this manual

5 Use socket wrench 8mm

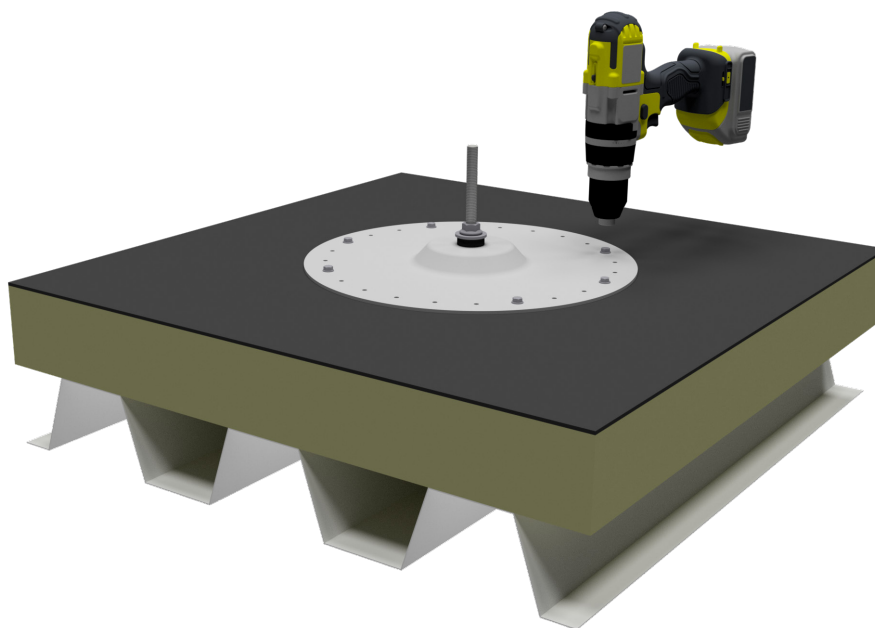

6 Advice installation membrane:



Advice size rosette:
- 540mm outer size
- 130mm inner size

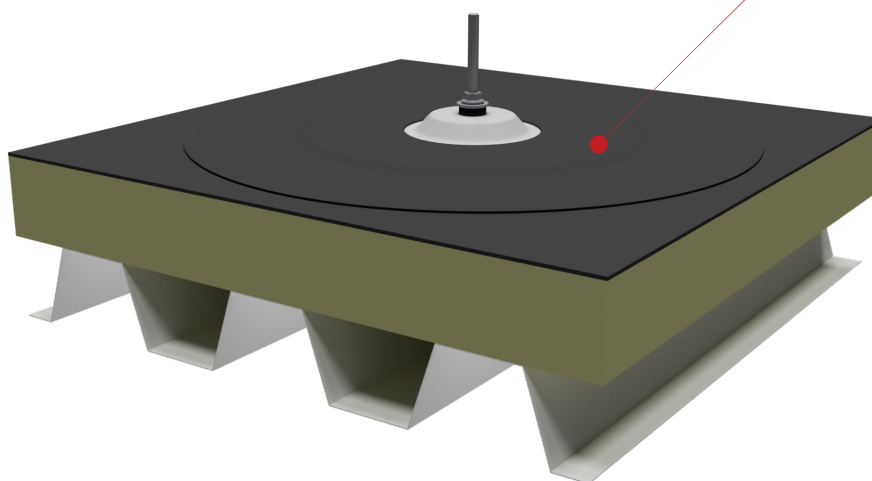

**For the watertight finishing of the consoles please contact your certified roofer.
Advice: first degrease the ValkSolarFix before making a watertight seal.**