

Move existing door opening

New door opening

Close up existing opening

New door openings

Close up existing door opening

Lower Ground Floor

**7 PILGRIMS LANE**

Studio Bernadeta  
AF Architects

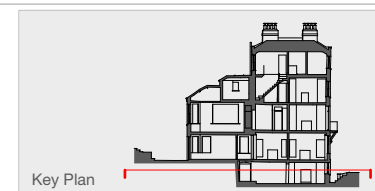

Key Plan

Project	037_7 PILGRIMS LANE
Drawing No.	037_PR.01
Drawing Title	PROPOSED LOWER GR FL
Issue	24.09.17
Project No.	037
Scale/Format	1:50 @ A3
Date	JANUARY 2025

New walls and door  
to create WC

New open plan  
kitchen arrangement

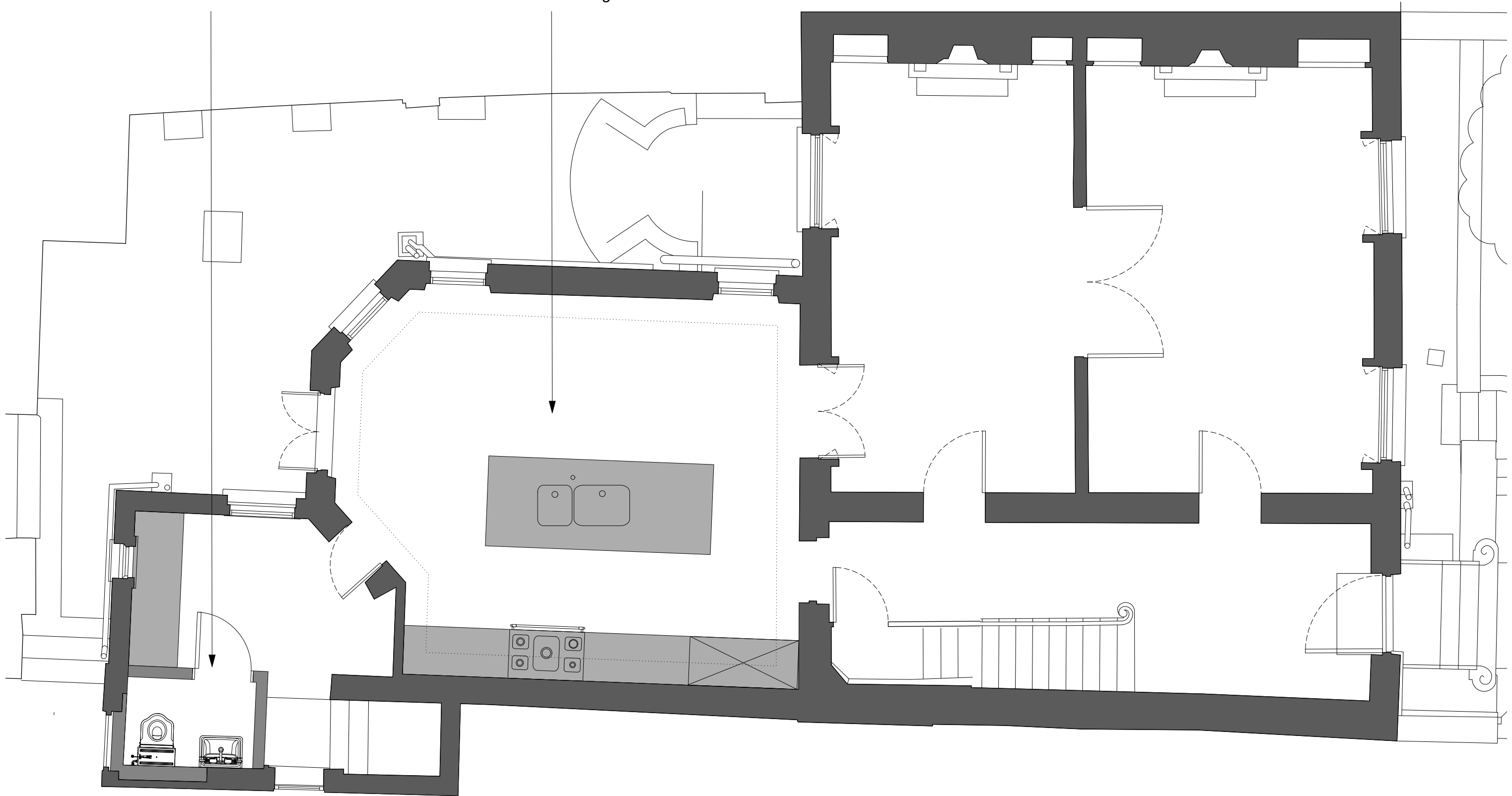

Ground Floor

## 7 PILGRIMS LANE

Studio Bernadeta  
AF Architects



Project	037_7 PILGRIMS LANE
Drawing No.	037_PR.02
Drawing Title	PROPOSED GROUND FL
Issue	24.09.17
Project No.	037
Scale/Format	1:50 @ A3
Date	JANUARY 2025

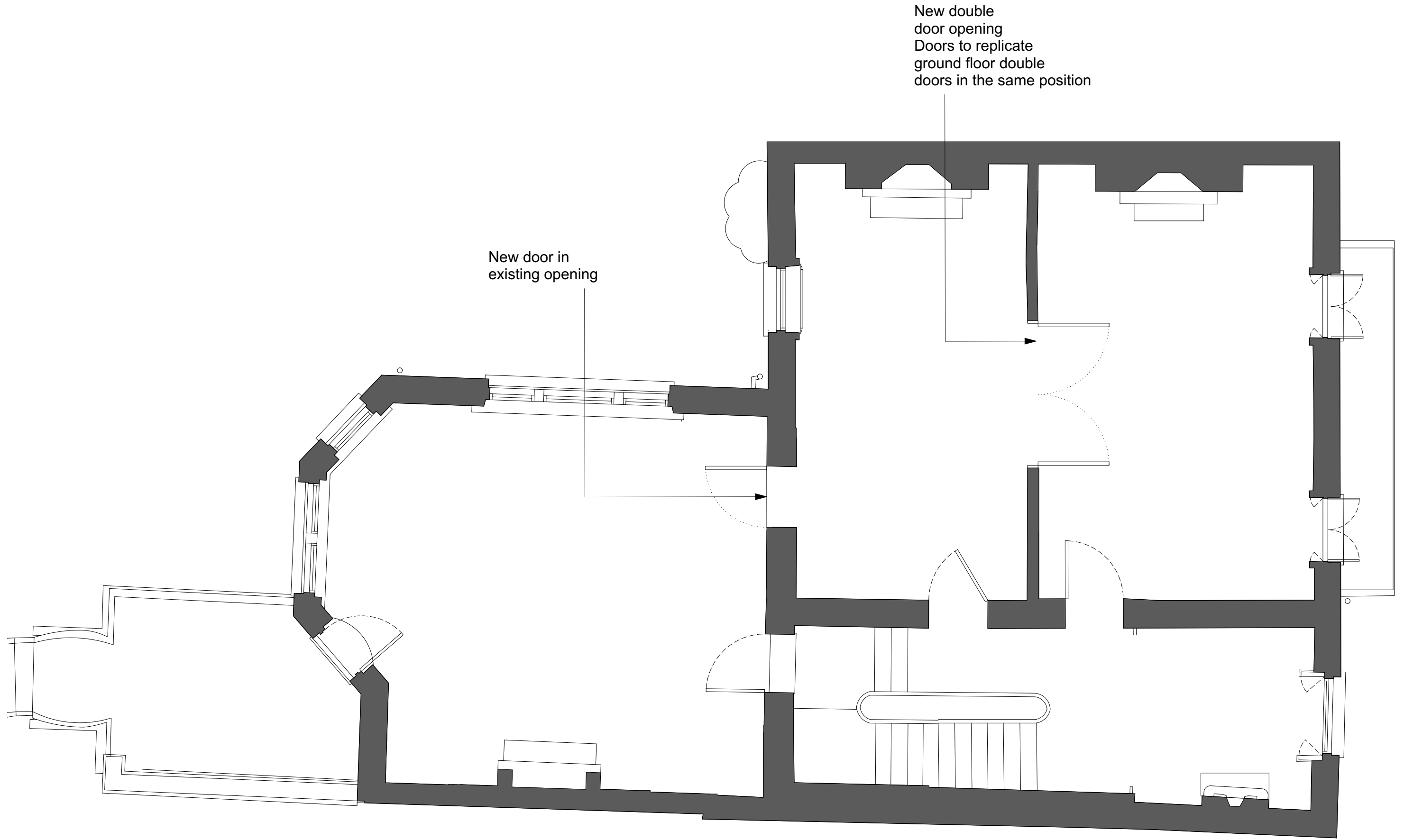

First Floor

**7 PILGRIMS LANE**

Studio Bernadeta  
AF Architects

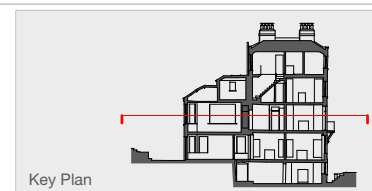

Key Plan

Project	037_7 PILGRIMS LANE
Drawing No.	037_PR.03
Drawing Title	PROPOSED FIRST FLOOR
Issue	24.09.17
Project No.	037
Scale/Format	1:50 @ A3
Date	JANUARY 2025

New door opening  
with replica historic  
door

Block existing non  
original door opening

New bathroom  
configuration

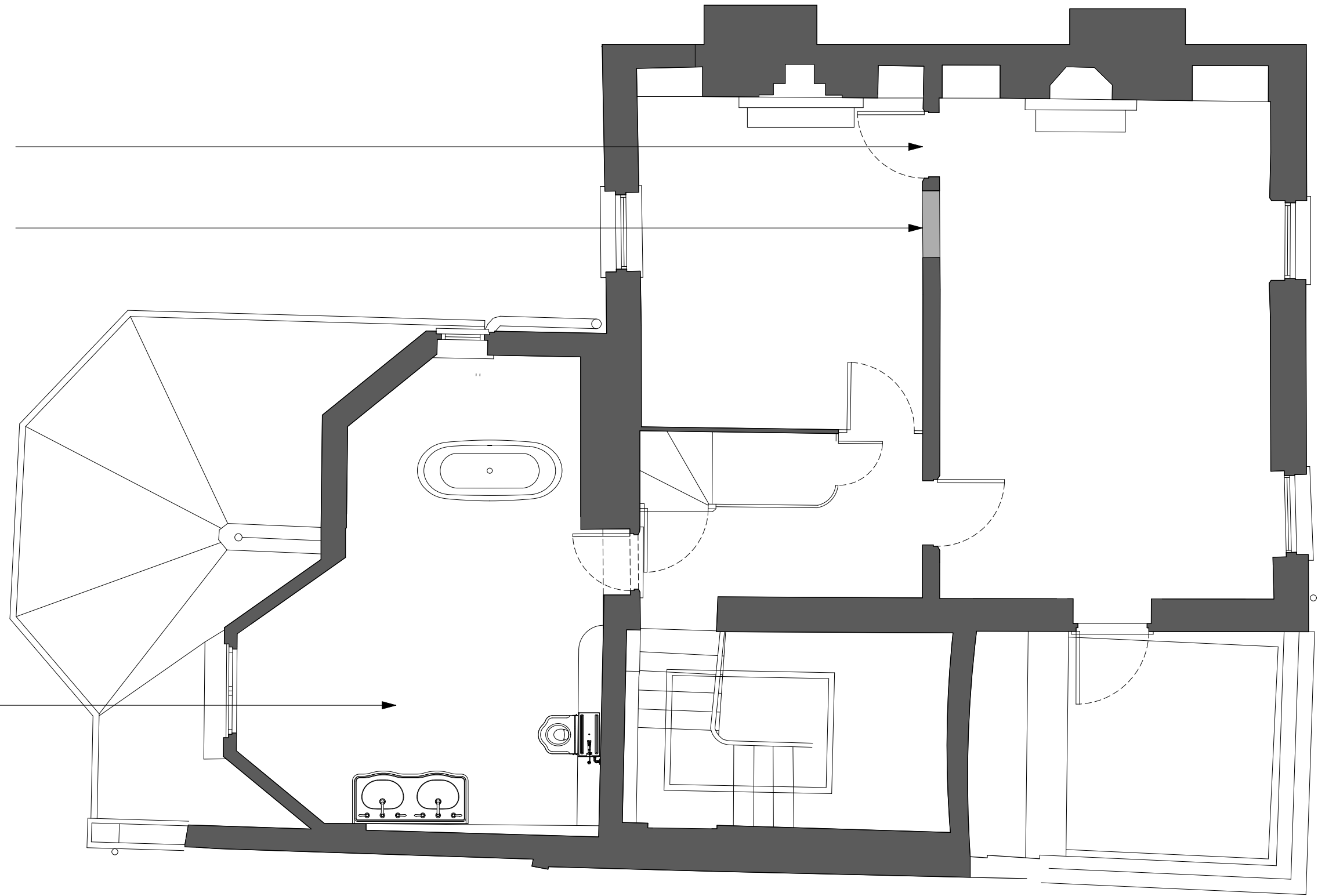

Second Floor

## 7 PILGRIMS LANE

Studio Bernadeta  
AF Architects

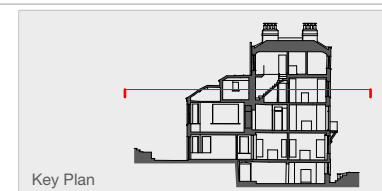

Key Plan

Project	037_7 PILGRIMS LANE
Drawing No.	037_PR.04
Drawing Title	PROPOSED SECOND FL
Issue	24.09.17
Project No.	037
Scale/Format	1:50 @ A3
Date	JANUARY 2025

New doors and  
architraves to  
match historic  
groundfloor  
features

New sanitaryware  
in existing shower  
room

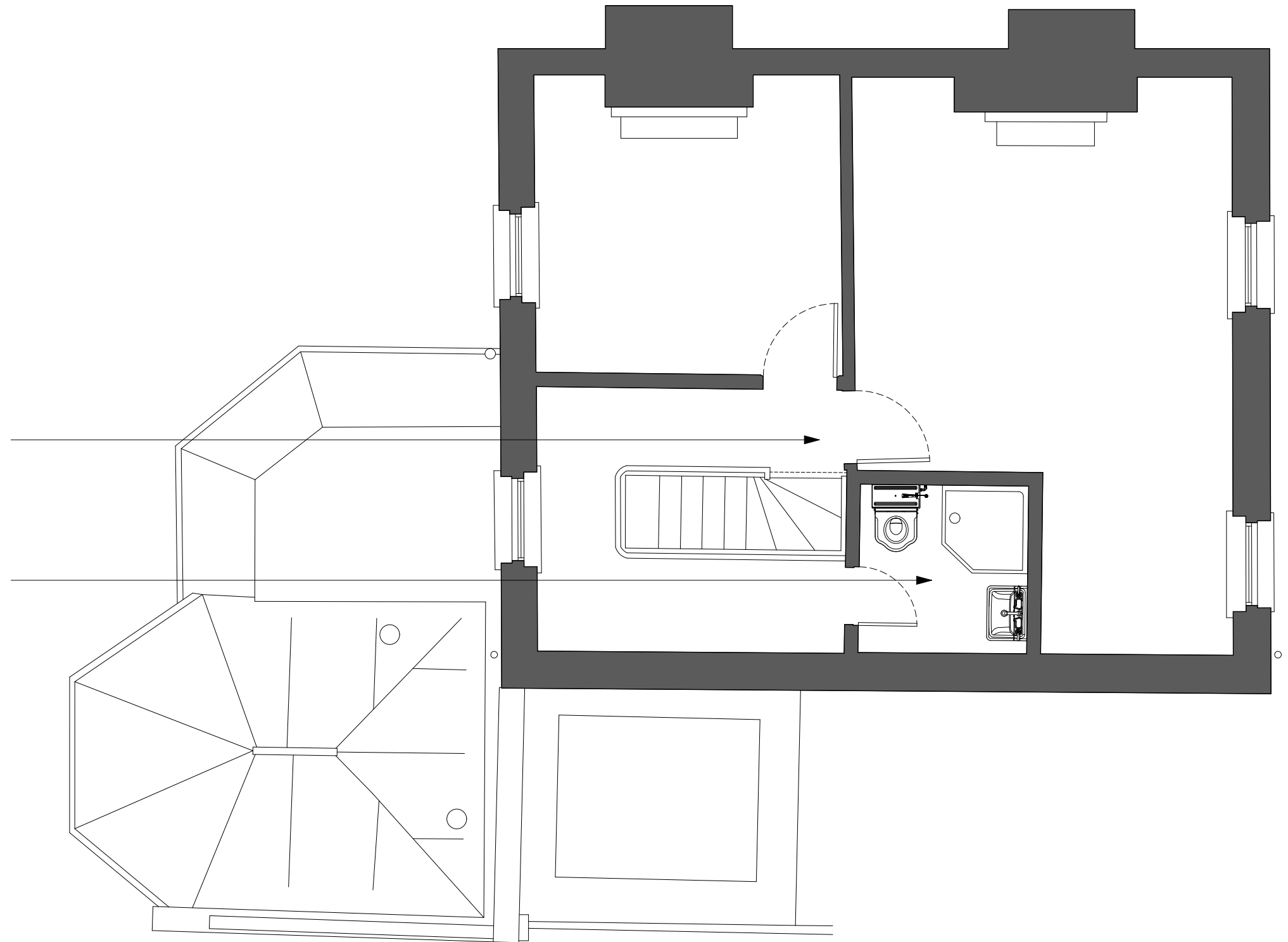

Third Floor

**7 PILGRIMS LANE**

Studio Bernadeta  
AF Architects

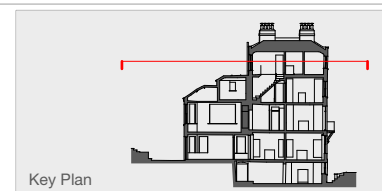

Key Plan

Project	037_7 PILGRIMS LANE
Drawing No.	037_PR.05
Drawing Title	PROPOSED THIRD FLOOR
Issue	24.09.17
Project No.	037
Scale/Format	1:50 @ A3
Date	JANUARY 2025



Street Front Elevation

**7 PILGRIMS LANE**

Studio Bernadeta  
AF Architects

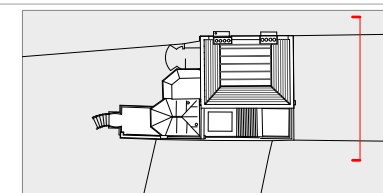

Project	037_7 PILGRIMS LANE
Drawing No.	037_PR.010
Drawing Title	PROP STR. FRONT ELEVATION
Issue	17.01.25
Project No.	037
Scale/Format	1:100 @ A3
Date	JANUARY 2025



Replace all uPVC rainwater goods with cast iron

Investigation works to existing front balcony to ensure structurally sound for purpose

Replaced door trims to ensure air tight and secure door

Replace unsafe stone step with new stone step to match existing

Replace moulded render with breathable render

Front Elevation

**7 PILGRIMS LANE**

Studio Bernadeta  
AF Architects

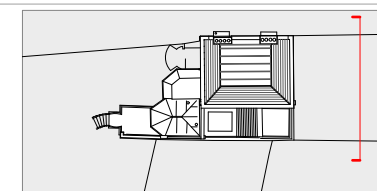

Project 037\_7 PILGRIMS LANE  
 Drawing No. 037\_PR.011  
 Drawing Title PROPOSED FRONT ELEVATION  
 Issue 17.01.25  
 Project No. 037  
 Scale/Format 1:100 @ A3  
 Date JANUARY 2025



Replace all broken /cracked slate tiles

Replace all uPVC rainwater goods with cast iron

Replace all broken /cracked slate tiles

Replace all broken /cracked slate tiles

Remove non original security grilles

Rear Elevation

**7 PILGRIMS LANE**

Studio Bernadeta  
AF Architects

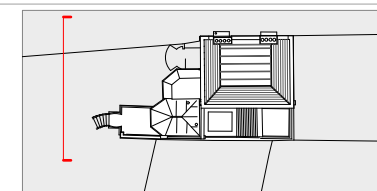

Project 037\_7 PILGRIMS LANE  
 Drawing No. 037\_PR.012  
 Drawing Title PROPOSED REAR ELEVATION  
 Issue 17.01.25  
 Project No. 037  
 Scale/Format 1:100 @ A3  
 Date JANUARY 2025



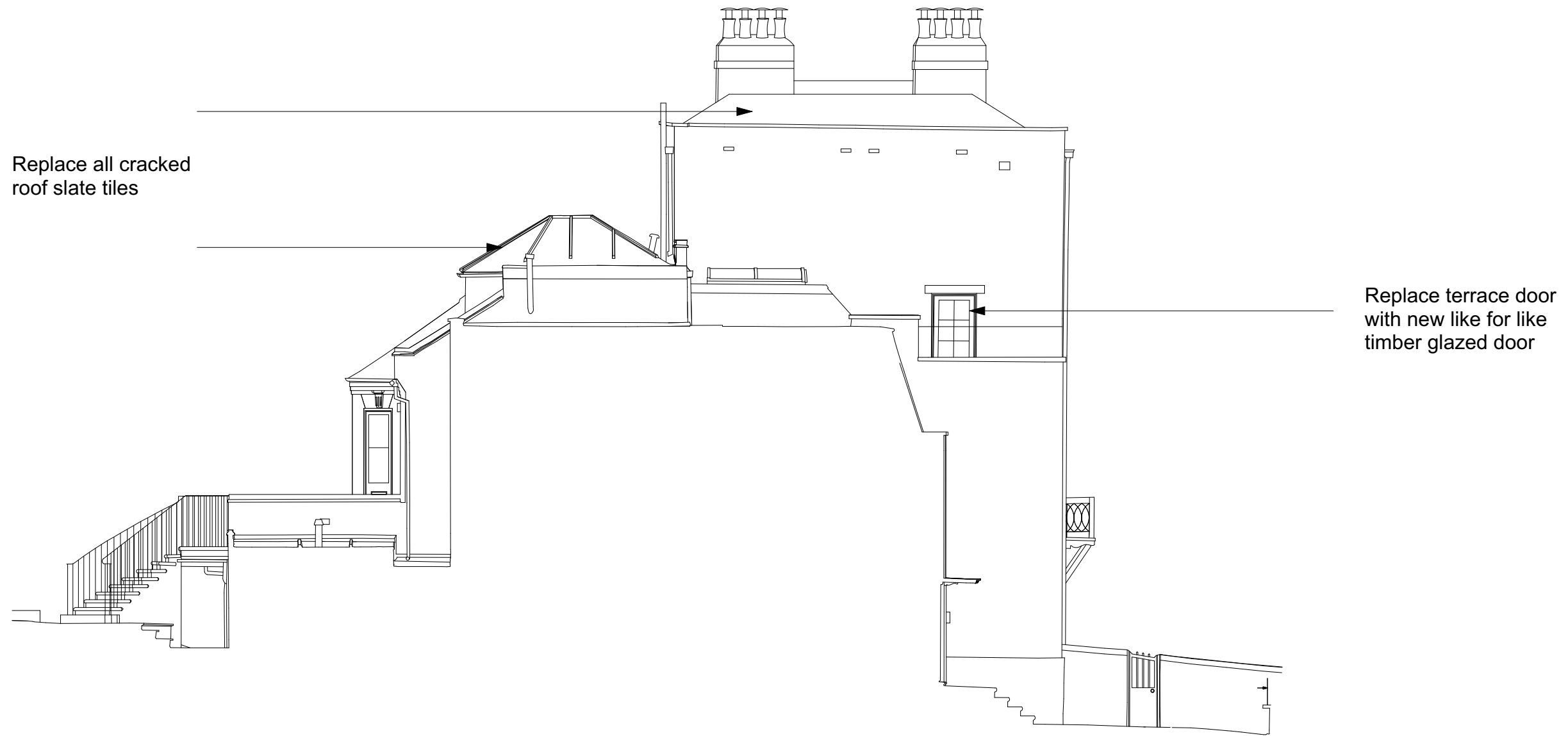

Side Elevation

**7 PILGRIMS LANE**

Studio Bernadeta  
AF Architects

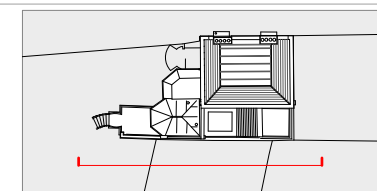

Project	037_7 PILGRIMS LANE
Drawing No.	037_PR.013
Drawing Title	PROPOSED SIDE ELEVATION
Issue	17.01.25
Project No.	037
Scale/Format	1:100 @ A3
Date	JANUARY 2025



New historical  
fireplace surrounds

Replace moulded render  
with breathable render

Section 01

**7 PILGRIMS LANE**

Studio Bernadeta  
AF Architects

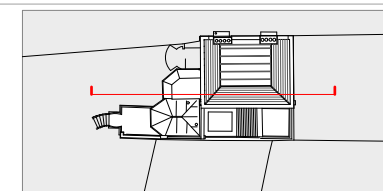

Project	037_7 PILGRIMS LANE
Drawing No.	037_PR.020
Drawing Title	PROPOSED SECTION 01
Issue	17.01.25
Project No.	037
Scale/Format	1:100 @ A3
Date	JANUARY 2025

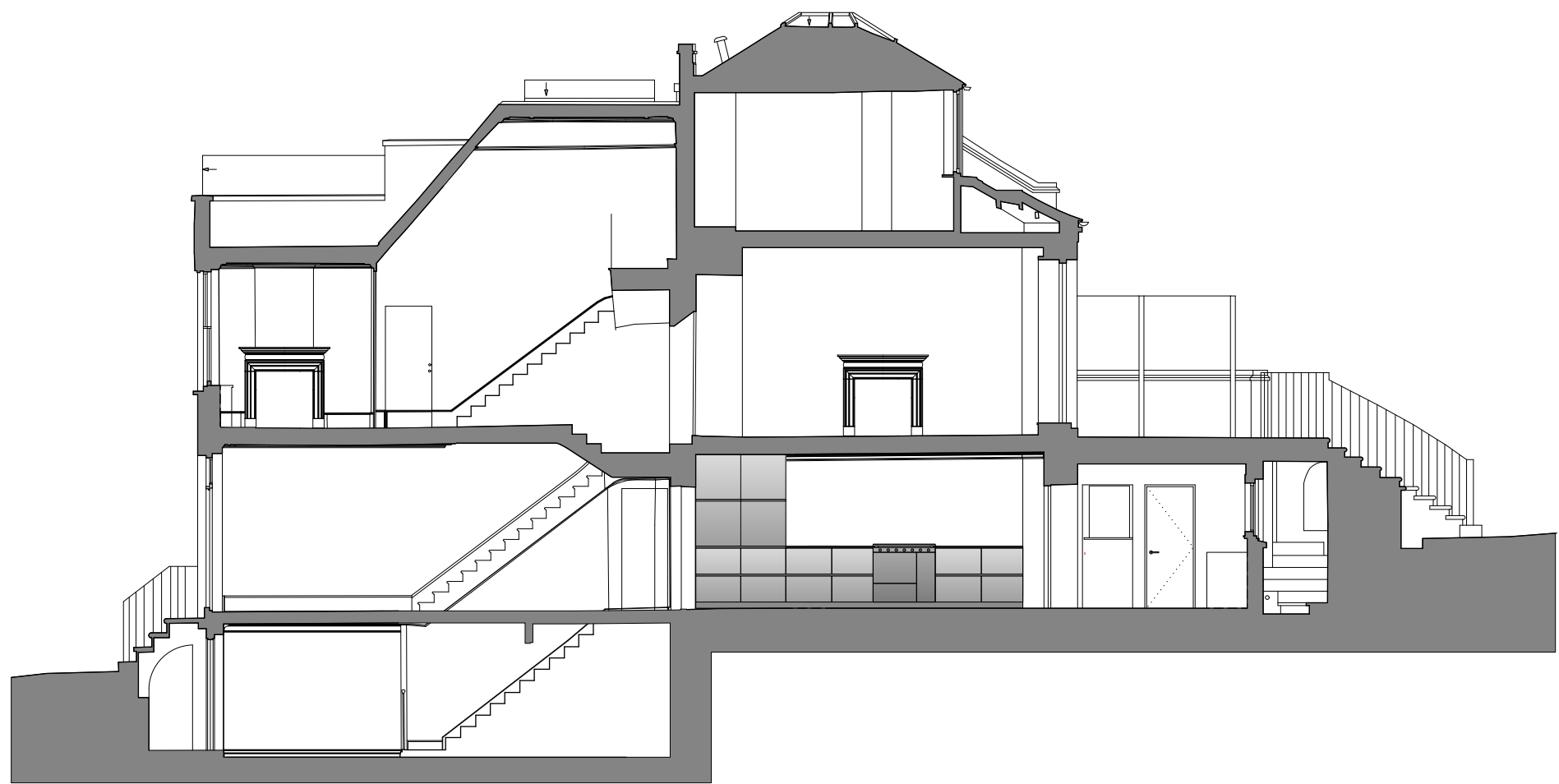

Section 02

## 7 PILGRIMS LANE

Studio Bernadeta  
AF Architects

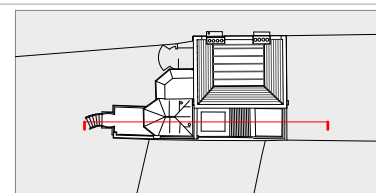

Project	037_7 PILGRIMS LANE
Drawing No.	037_PR.021
Drawing Title	PROPOSED SECTION 02
Issue	17.01.25
Project No.	037
Scale/Format	1:100 @ A3
Date	JANUARY 2025



Section 03

## 7 PILGRIMS LANE

Studio Bernadeta  
AF Architects

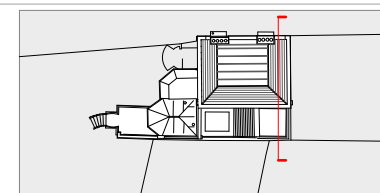

Project	037_7 PILGRIMS LANE
Drawing No.	037_PR.022
Drawing Title	PROPOSED SECTION 03
Issue	17.01.25
Project No.	037
Scale/Format	1:100 @ A3
Date	JANUARY 2025



Section 04

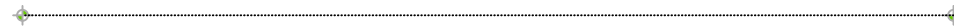

## 7 PILGRIMS LANE

Studio Bernadeta  
AF Architects

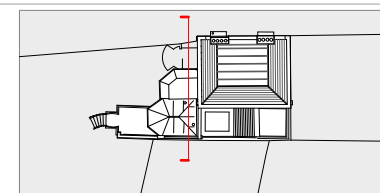

Project	037_7 PILGRIMS LANE
Drawing No.	037_PR.023
Drawing Title	PROPOSED SECTION 04
Issue	17.01.25
Project No.	037
Scale/Format	1:100 @ A3
Date	JANUARY 2025

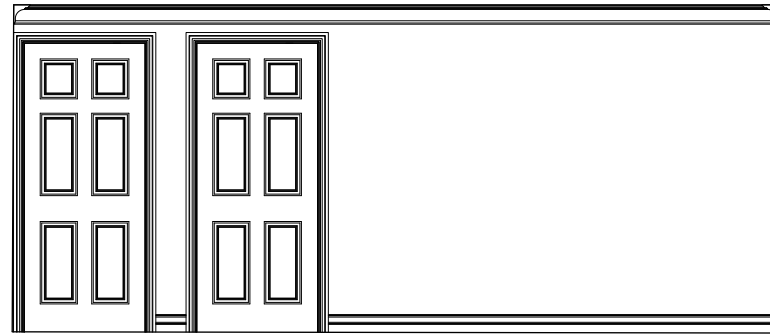

Elevation 1

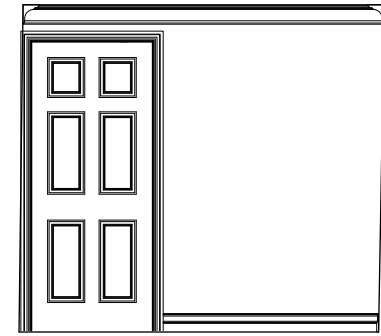

Elevation 2

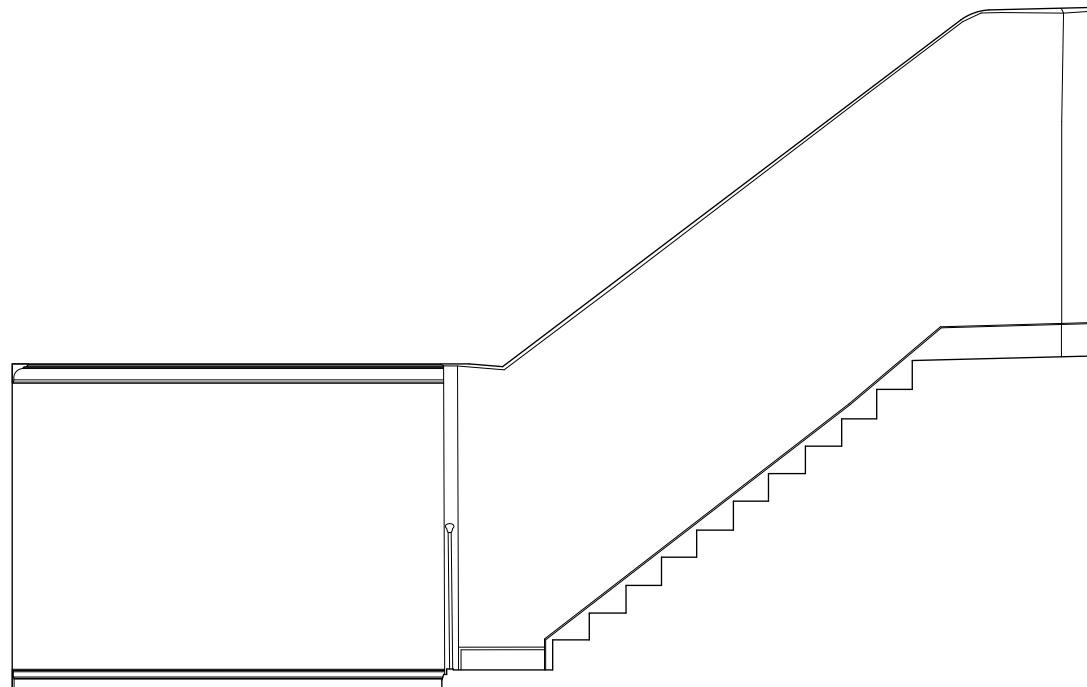
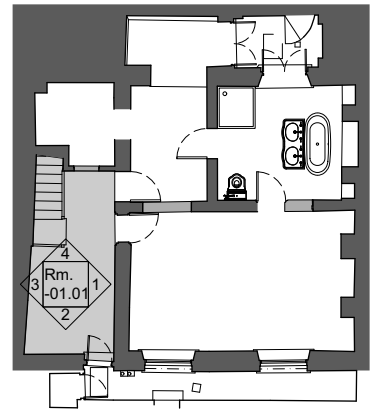

Elevation 3

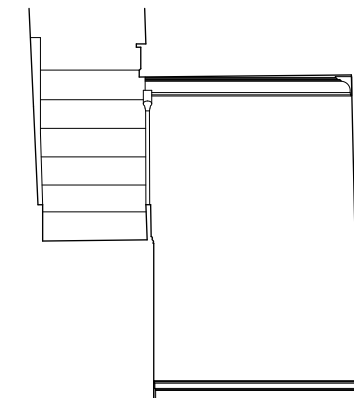

Elevation 4

**7 PILGRIMS LANE**

Studio Bernadeta  
AF Architects

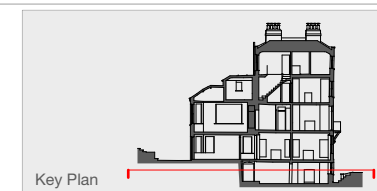

Key Plan

Project	037_7 PILGRIMS LANE
Drawing No.	037_PR.01_RM.-01.01
Drawing Title	PR. LR. GROUND FL._RM.01
Issue	17.01.25
Project No.	037
Scale/Format	1:100 @ A3
Date	JANUARY 2025

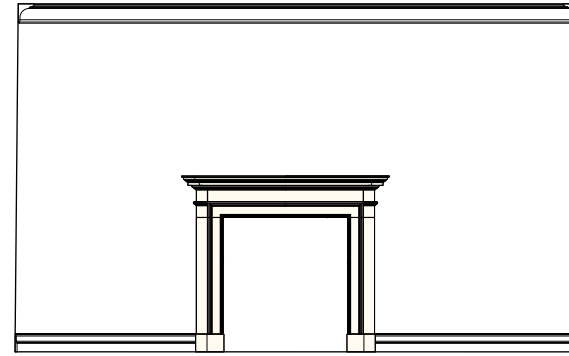

Elevation 1

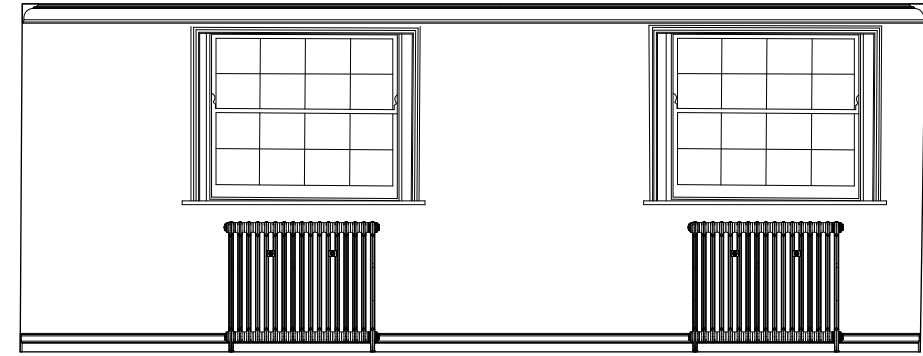

Elevation 2

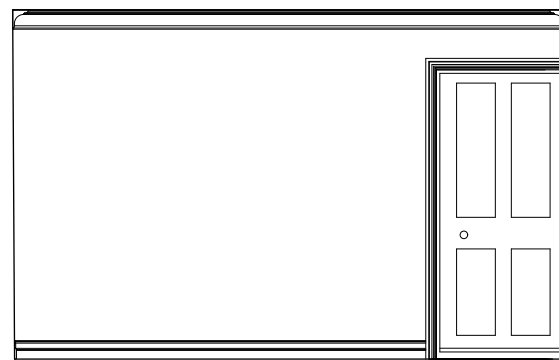
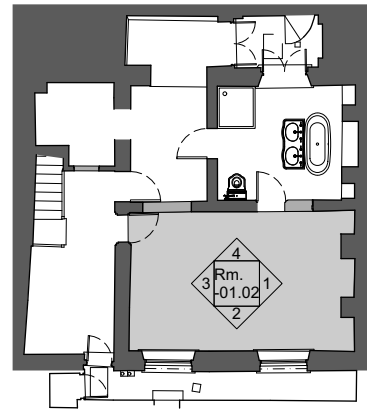

Elevation 3

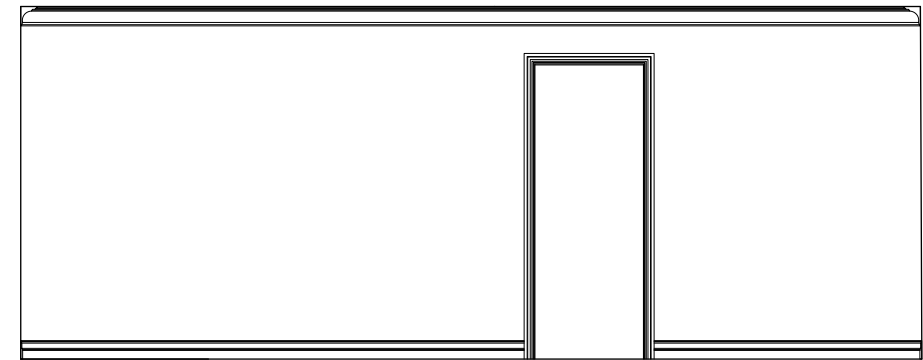

Elevation 4

**7 PILGRIMS LANE**

Studio Bernadeta  
AF Architects

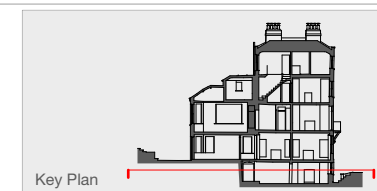

Project	037_7 PILGRIMS LANE
Drawing No.	037_PR.01_RM.-01.02
Drawing Title	PR. LR. GROUND FL._RM.02
Issue	17.01.25
Project No.	037
Scale/Format	1:100 @ A3
Date	JANUARY 2025

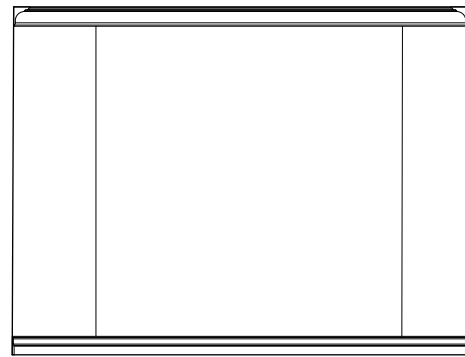

Elevation 1

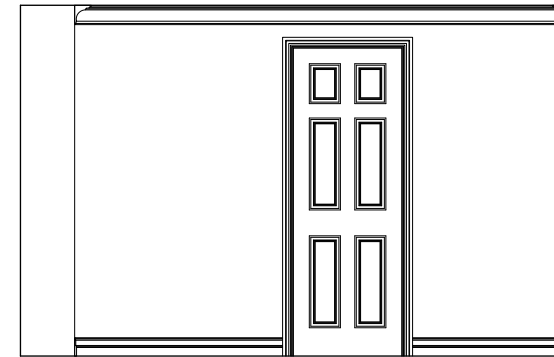

Elevation 2

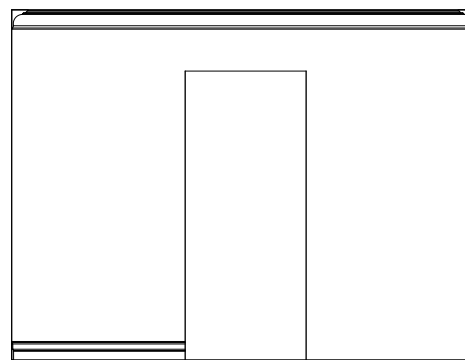
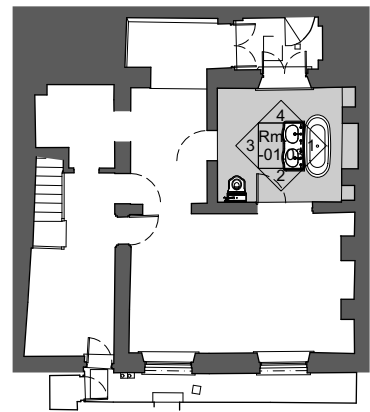

Elevation 3

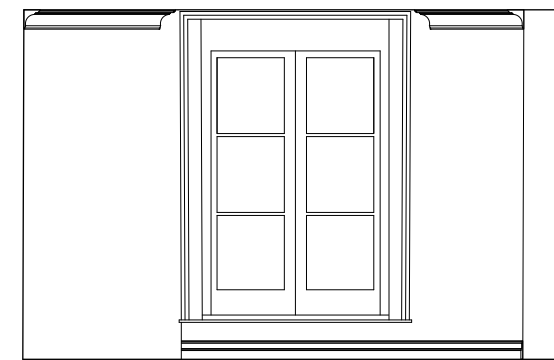

Elevation 4

**7 PILGRIMS LANE**

Studio Bernadeta  
AF Architects



Project 037\_7 PILGRIMS LANE  
 Drawing No. 037\_PR.01\_RM.-01.03  
 Drawing Title PR. LR. GROUND FL.\_RM.03  
 Issue 17.01.25  
 Project No. 037  
 Scale/Format 1:100 @ A3  
 Date JANUARY 2025



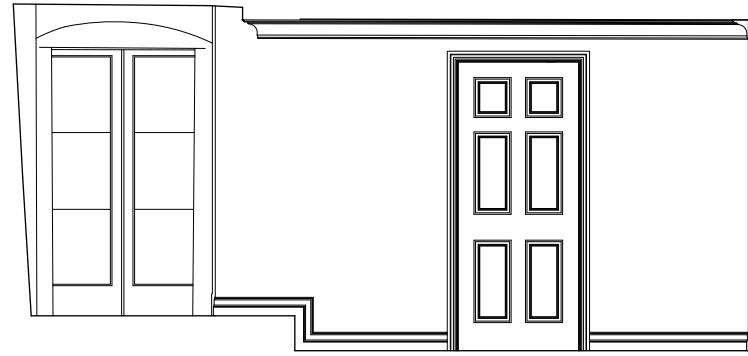

Elevation 1

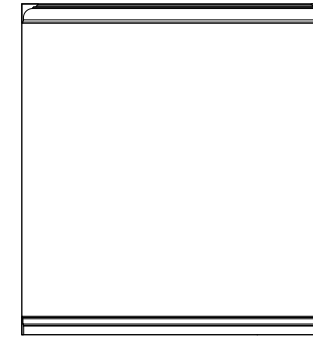

Elevation 2

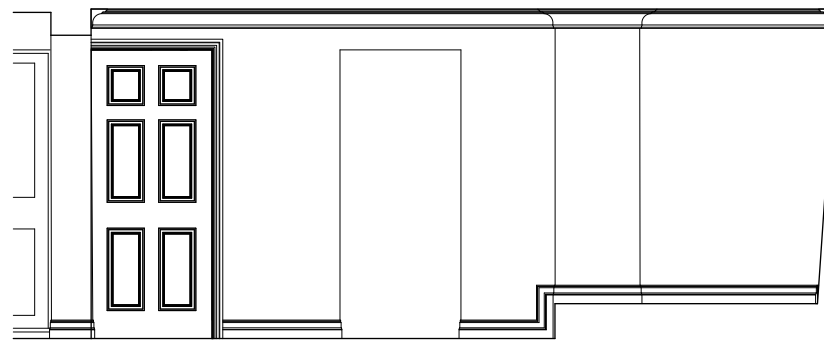
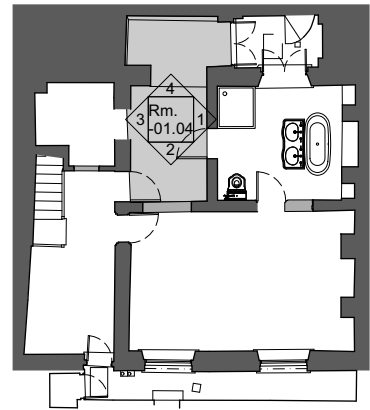

Elevation 3

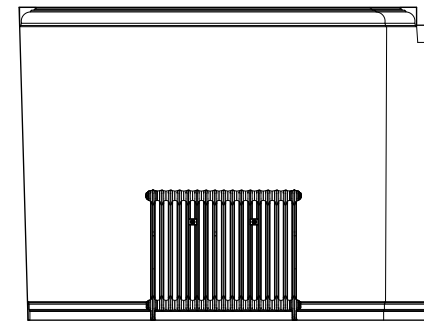

Elevation 4

**7 PILGRIMS LANE**

Studio Bernadeta  
AF Architects

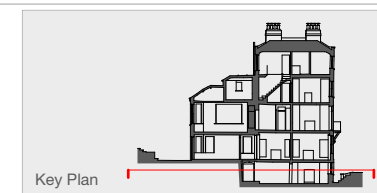

Project 037\_7 PILGRIMS LANE  
 Drawing No. 037\_PR.01\_RM.-01.04  
 Drawing Title PR. LR. GROUND FL.\_RM.04  
 Issue 17.01.25  
 Project No. 037  
 Scale/Format 1:100 @ A3  
 Date JANUARY 2025

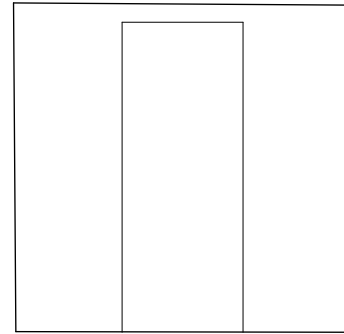

Elevation 1

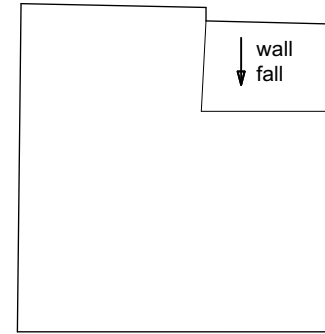

Elevation 2

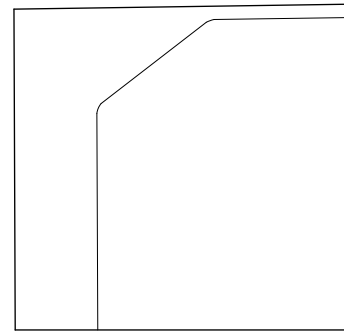

Elevation 3

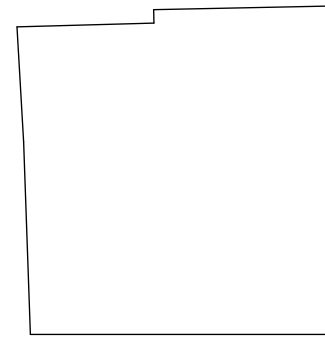

Elevation 4

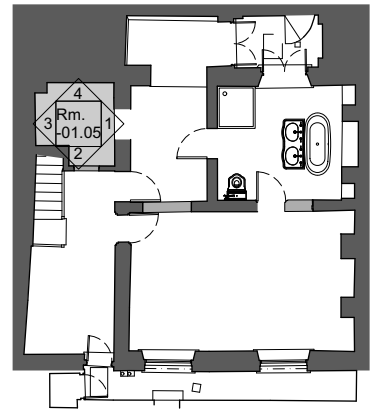

**7 PILGRIMS LANE**

Studio Bernadeta  
AF Architects

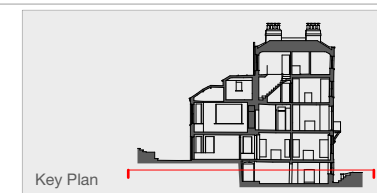

Project 037\_7 PILGRIMS LANE  
 Drawing No. 037\_PR.01\_RM.-01.05  
 Drawing Title PR. LR. GROUND FL.\_RM.05  
 Issue 17.01.25  
 Project No. 037  
 Scale/Format 1:100 @ A3  
 Date JANUARY 2025

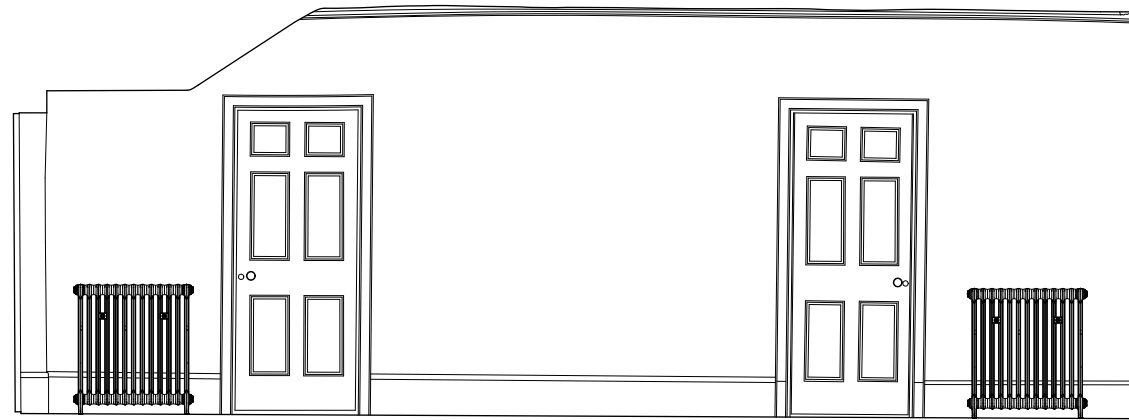

Elevation 1

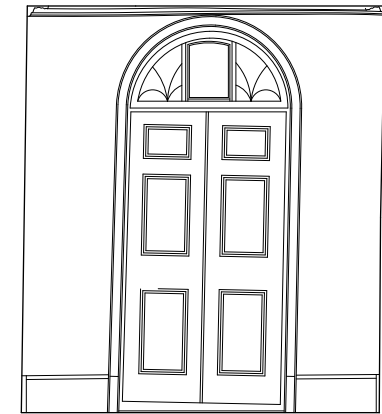

Elevation 2

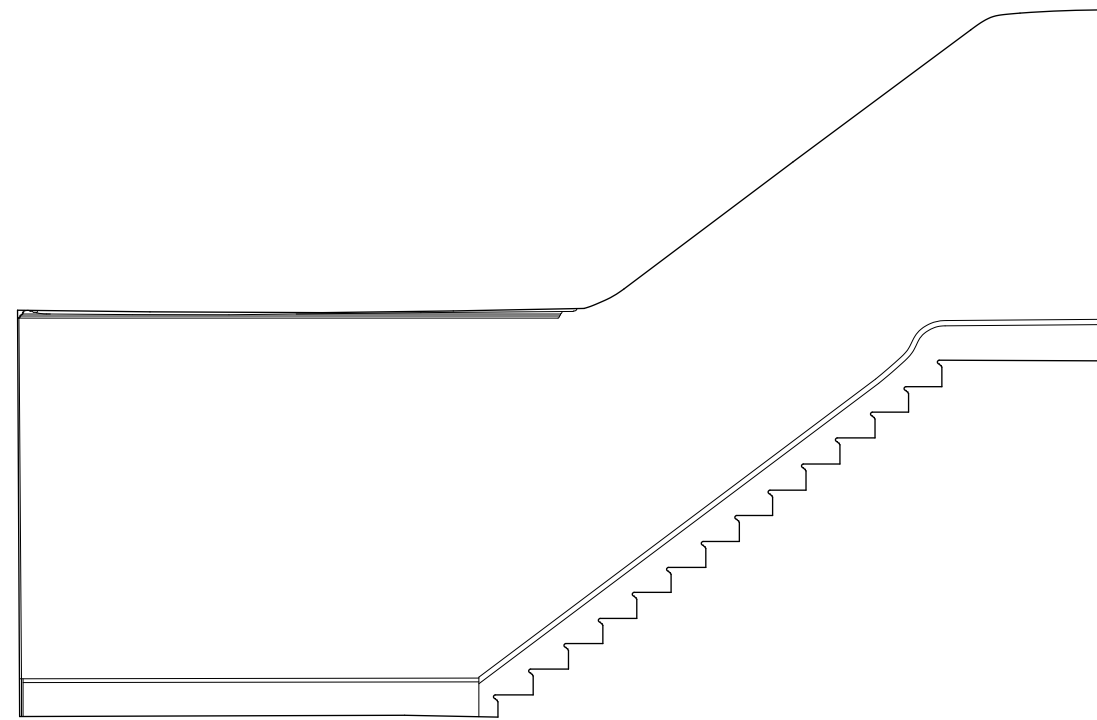
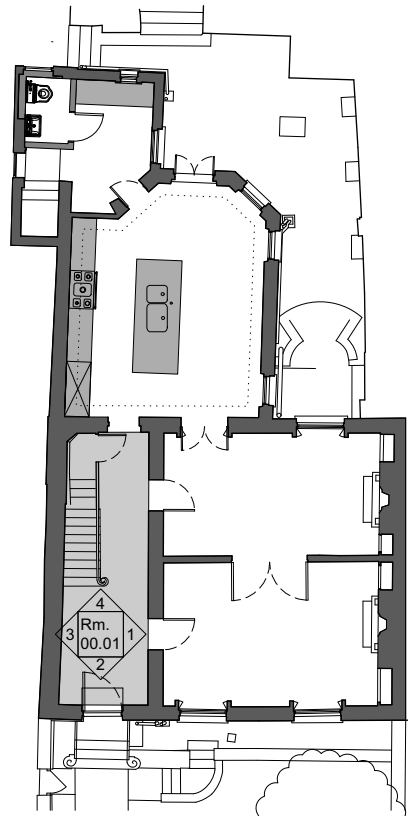

Elevation 3

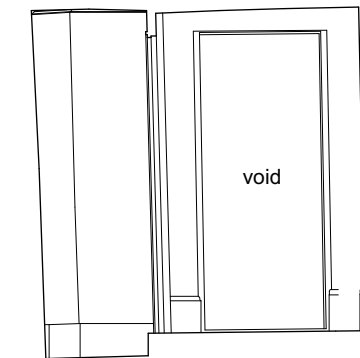

Elevation 4

**7 PILGRIMS LANE**

Studio Bernadeta  
AF Architects

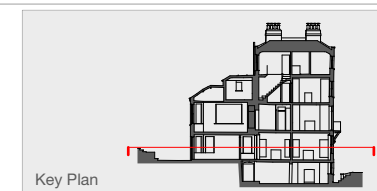

Key Plan

Project 037\_7 PILGRIMS LANE  
 Drawing No. 037\_PR.02\_RM.00.01  
 Drawing Title PR. GROUND FL.\_RM.01  
 Issue 17.01.25  
 Project No. 037  
 Scale/Format 1:100 @ A3  
 Date JANUARY 2025

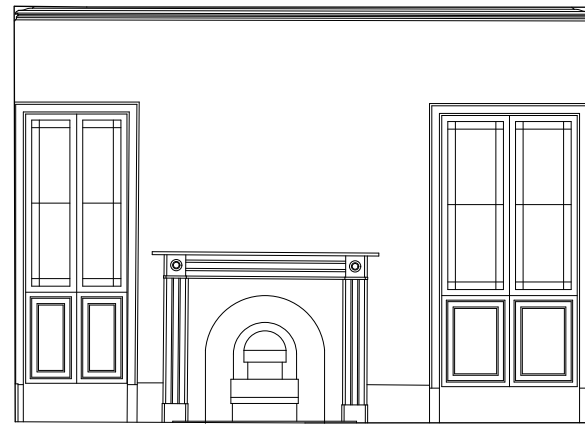

Elevation 1



Elevation 2

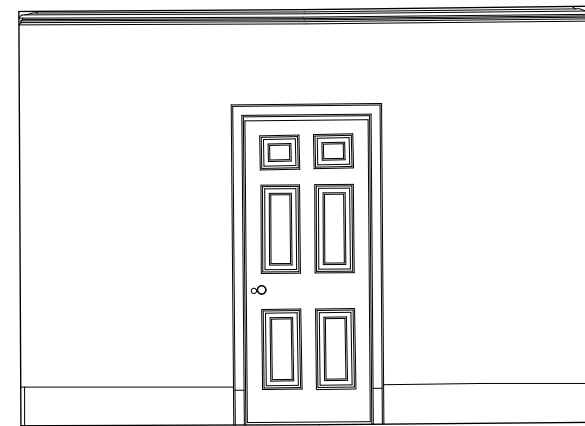
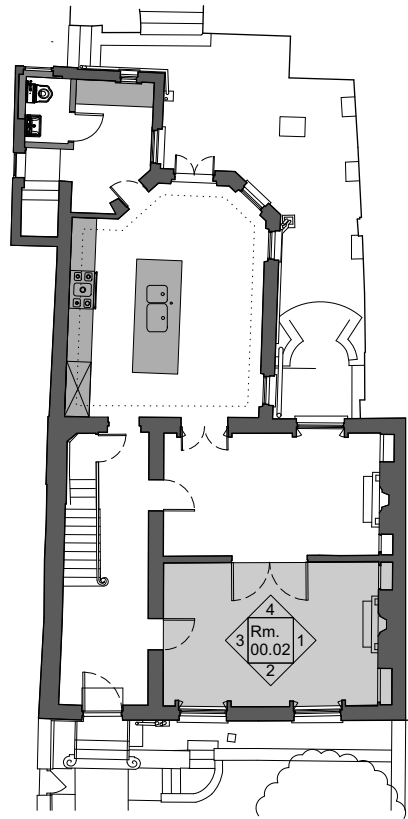

Elevation 3

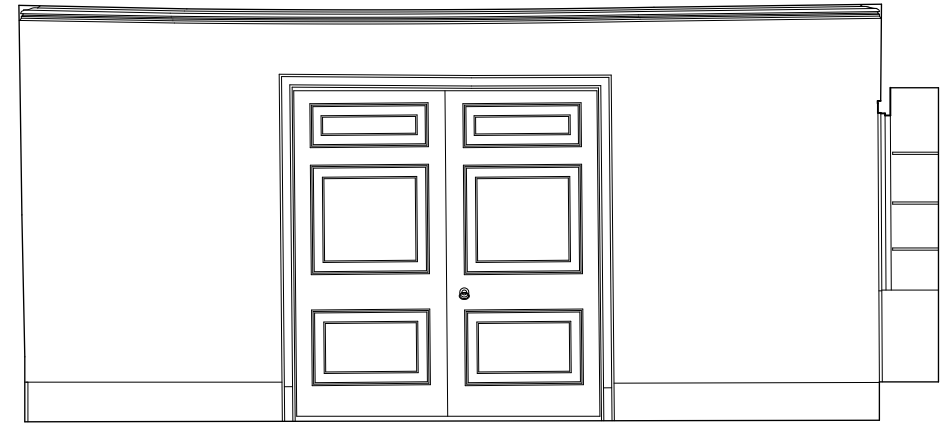

Elevation 4

**7 PILGRIMS LANE**

Studio Bernadeta  
AF Architects

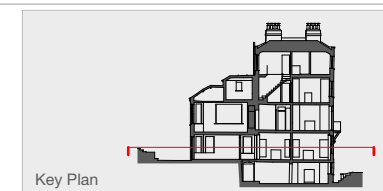

Key Plan

Project	037_7 PILGRIMS LANE
Drawing No.	037_PR.02_RM.00.02
Drawing Title	PR. GROUND FL._RM.02
Issue	17.01.25
Project No.	037
Scale/Format	1:100 @ A3
Date	JANUARY 2025



Elevation 1

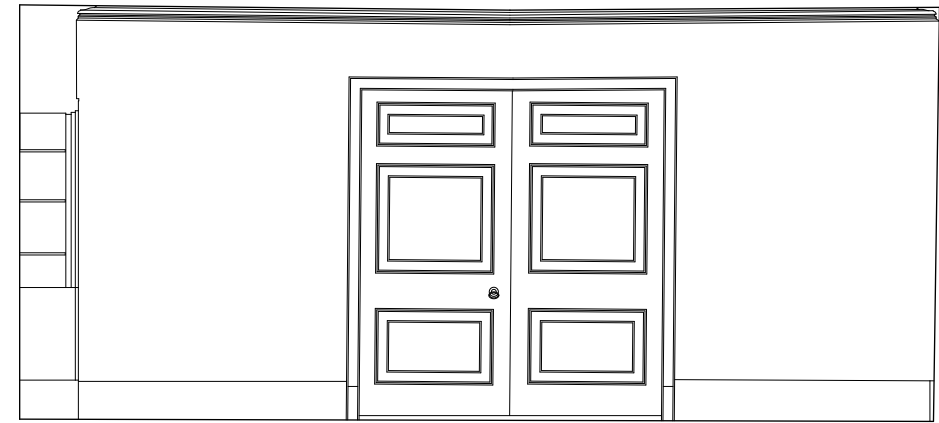

Elevation 2

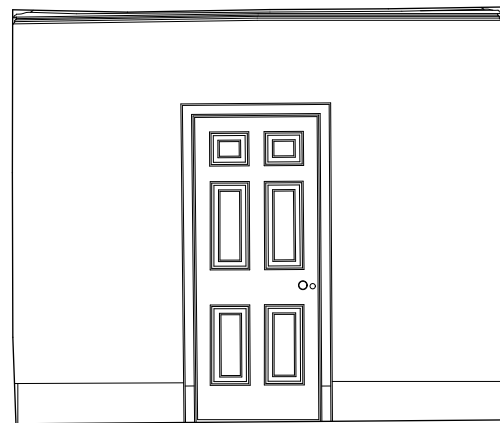
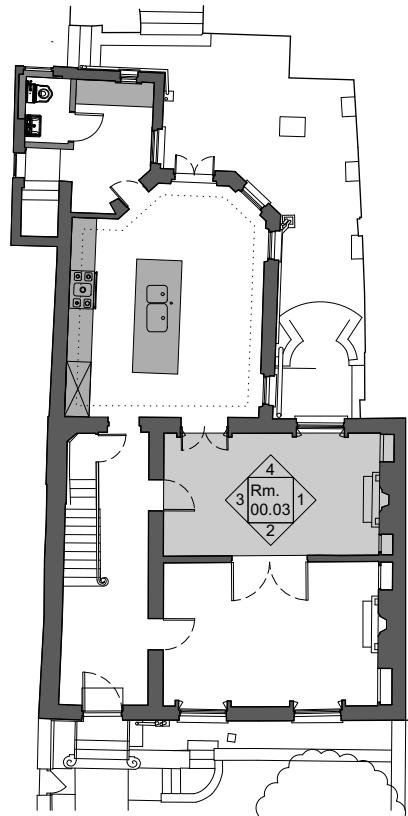

Elevation 3



Elevation 4

**7 PILGRIMS LANE**

Studio Bernadeta  
AF Architects

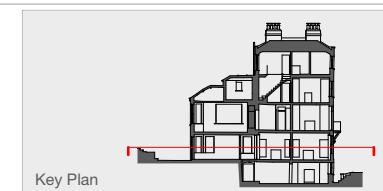

Key Plan

Project	037_7 PILGRIMS LANE
Drawing No.	037_PR.02_RM.00.03
Drawing Title	PR. GROUND FL._RM.03
Issue	17.01.25
Project No.	037
Scale/Format	1:100 @ A3
Date	JANUARY 2025

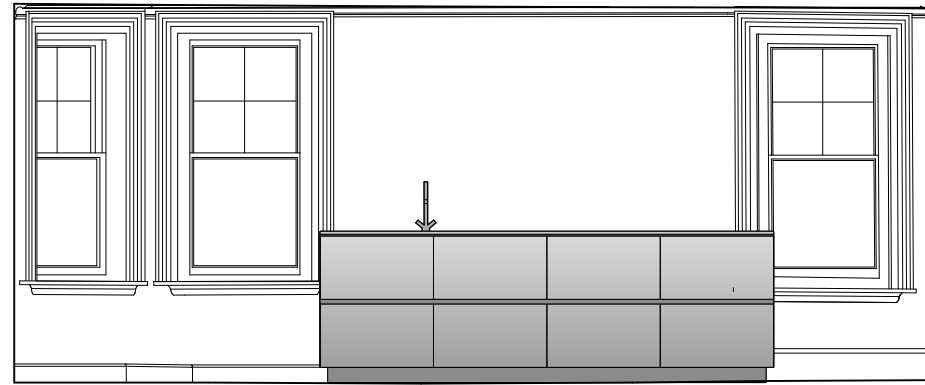

Elevation 1

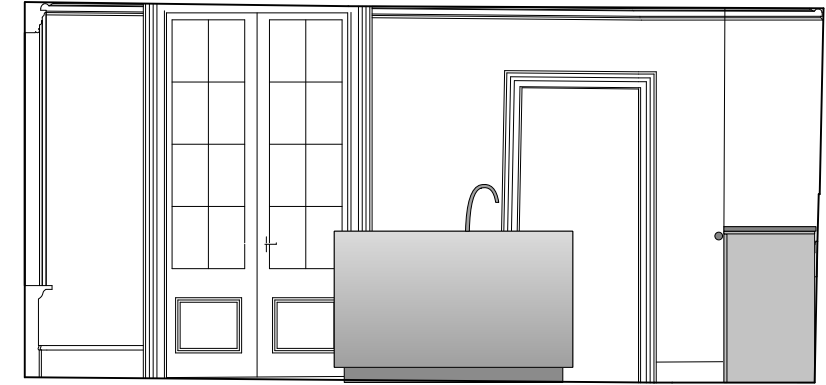

Elevation 2

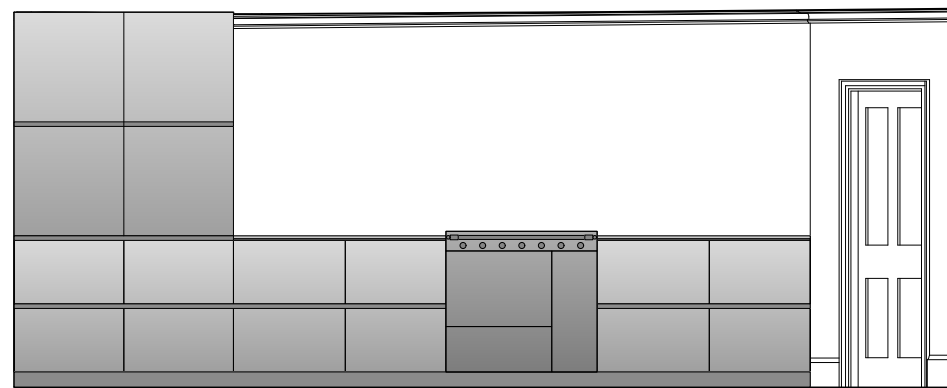
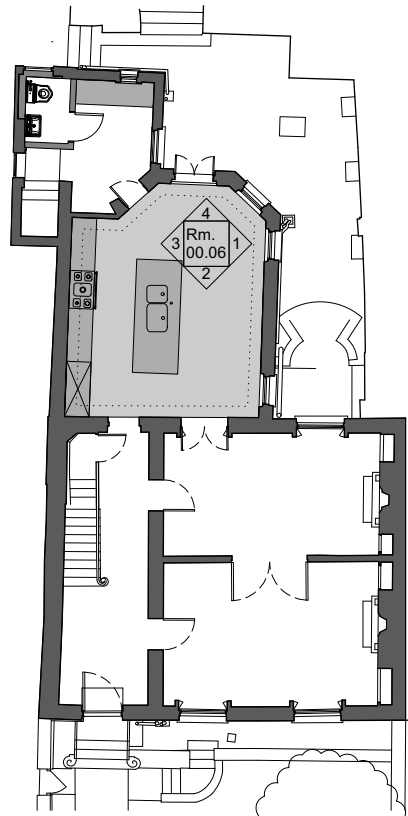

Elevation 3



Elevation 4

## 7 PILGRIMS LANE

Studio Bernadeta  
AF Architects

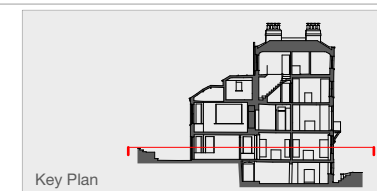

Project	037_7 PILGRIMS LANE
Drawing No.	037_PR.02_RM.00.06
Drawing Title	PR. GROUND FL._RM.06
Issue	17.01.25
Project No.	037
Scale/Format	1:100 @ A3
Date	JANUARY 2025

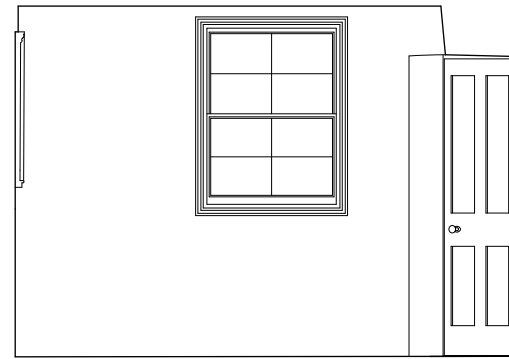

Elevation 1

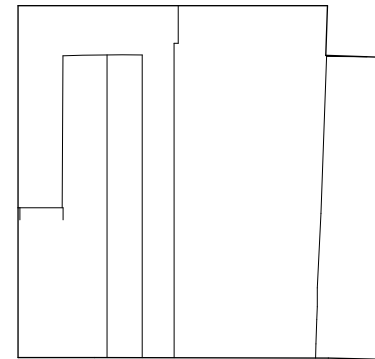

Elevation 2

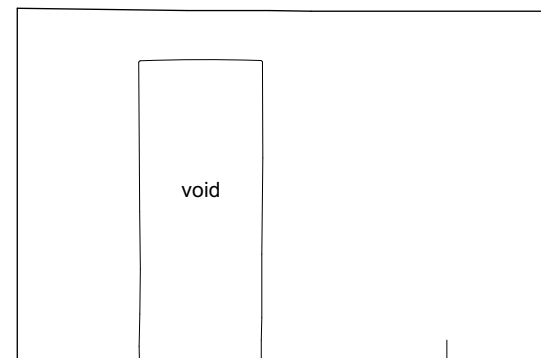
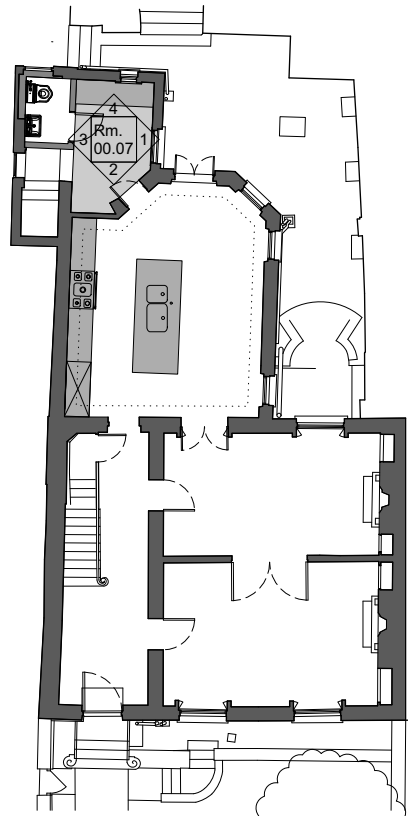

Elevation 3

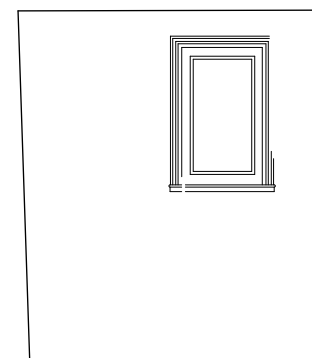

Elevation 4

**7 PILGRIMS LANE**

Studio Bernadeta  
AF Architects

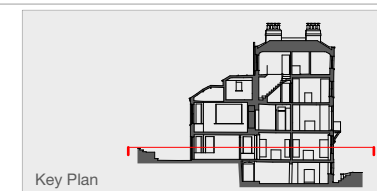

Key Plan

Project 037\_7 PILGRIMS LANE  
 Drawing No. 037\_PR.02\_RM.00.07  
 Drawing Title PR. GROUND FL.\_RM.07  
 Issue 17.01.25  
 Project No. 037  
 Scale/Format 1:100 @ A3  
 Date JANUARY 2025

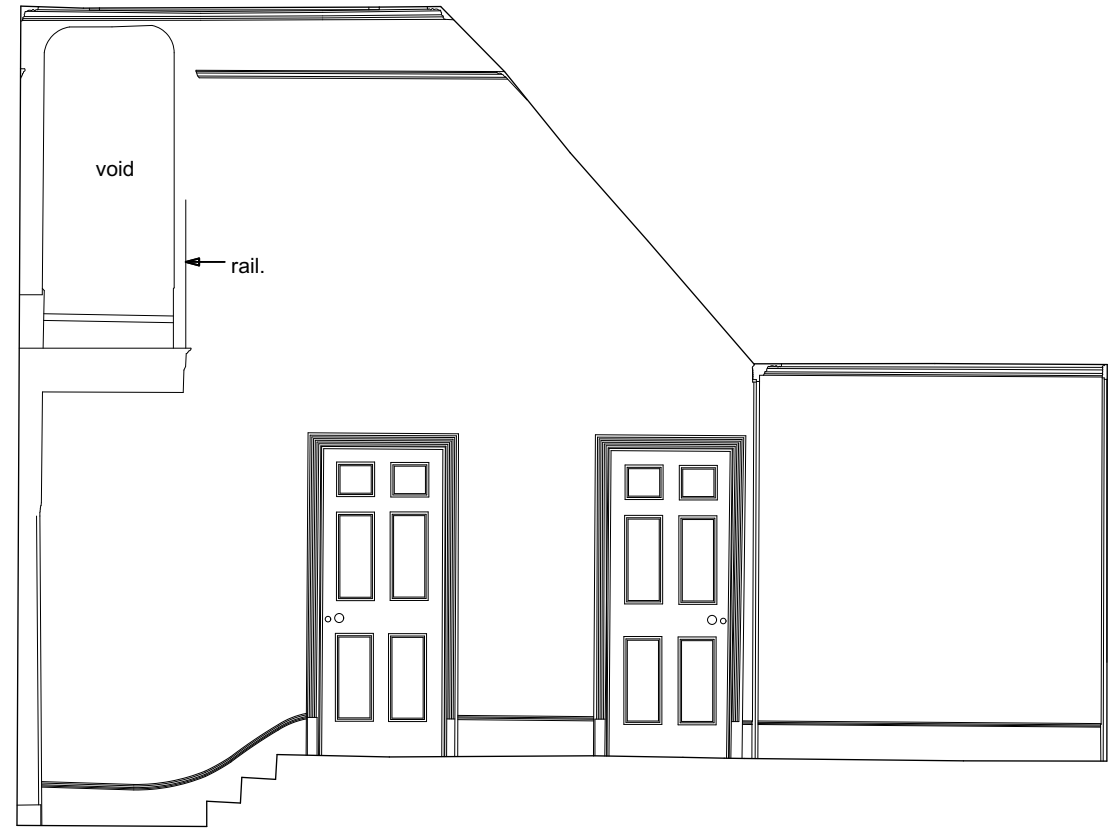
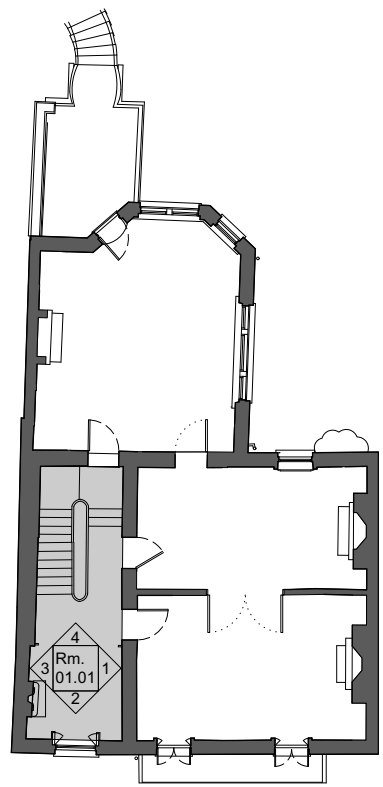

Elevation 1

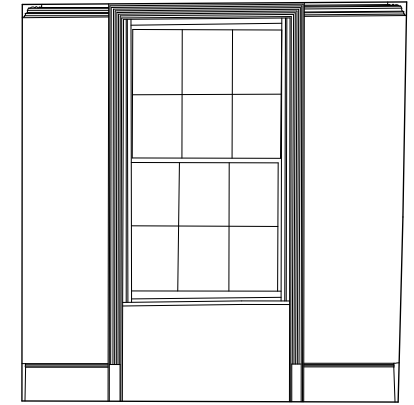

Elevation 2

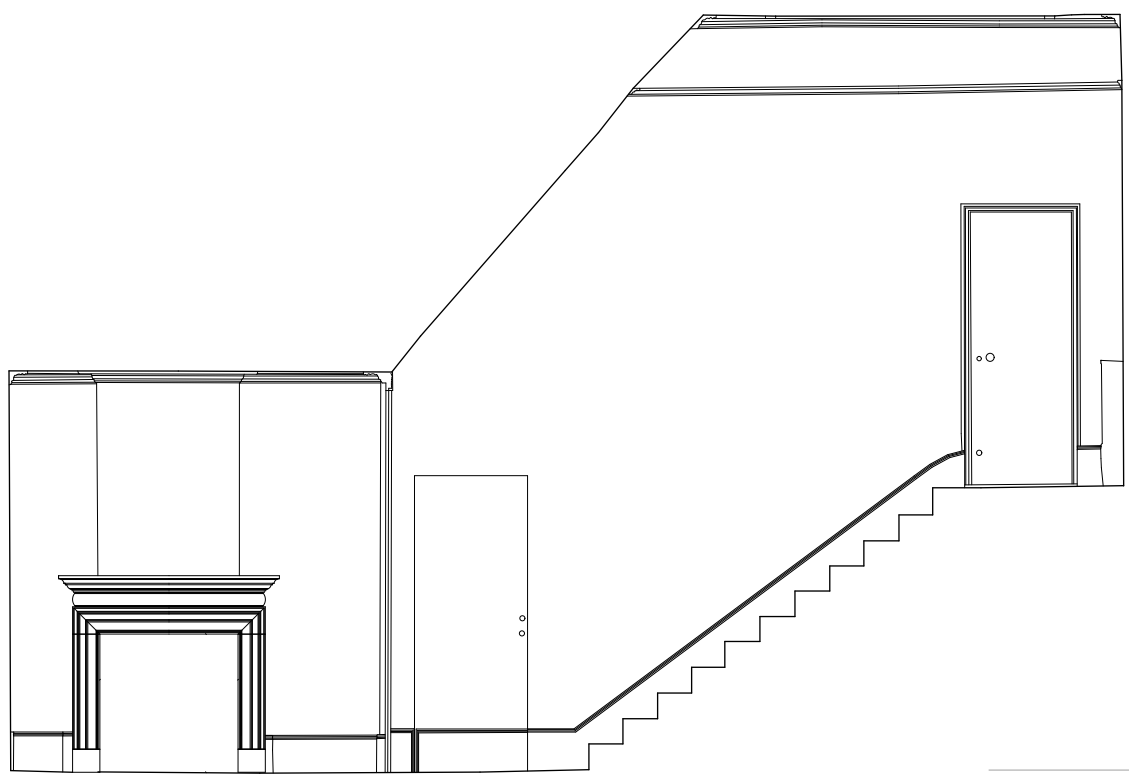

Elevation 3

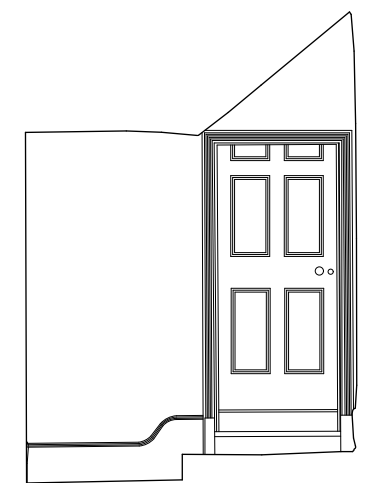

Elevation 4

**7 PILGRIMS LANE**

Studio Bernadeta  
AF Architects

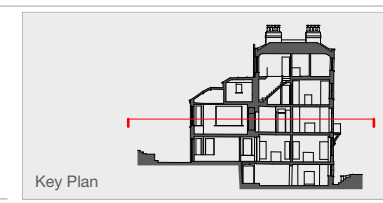

Key Plan

Project	037_7 PILGRIMS LANE
Drawing No.	037_PR.03_RM.01.01
Drawing Title	PR. FIRST FL._RM.01
Issue	17.01.25
Project No.	037
Scale/Format	1:100 @ A3
Date	JANUARY 2025



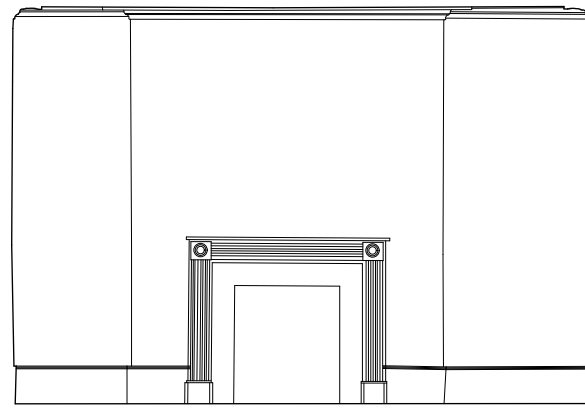

Elevation 1

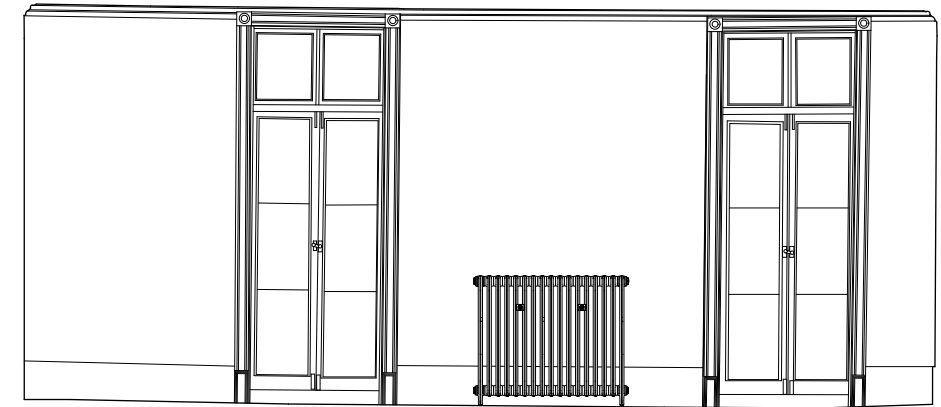

Elevation 2

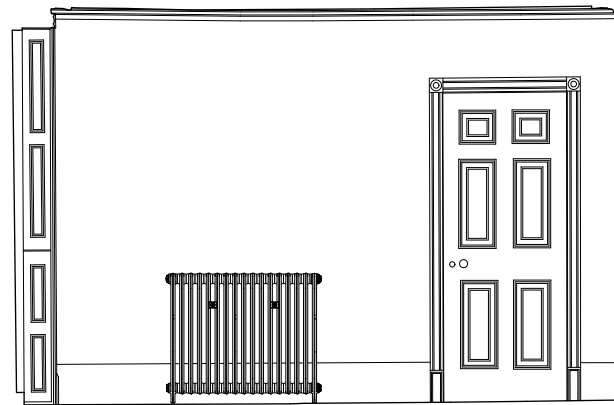
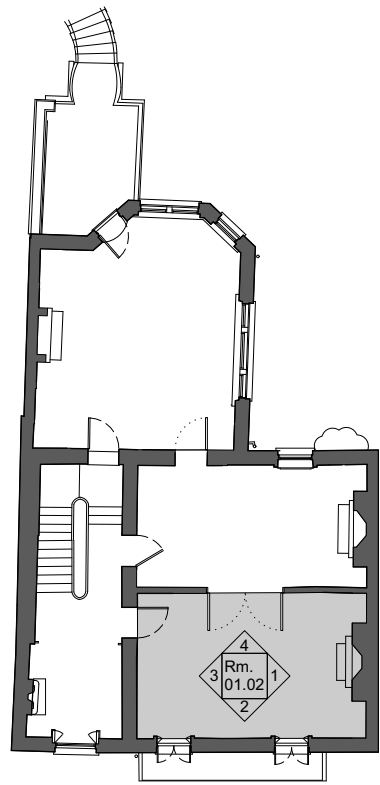

Elevation 3

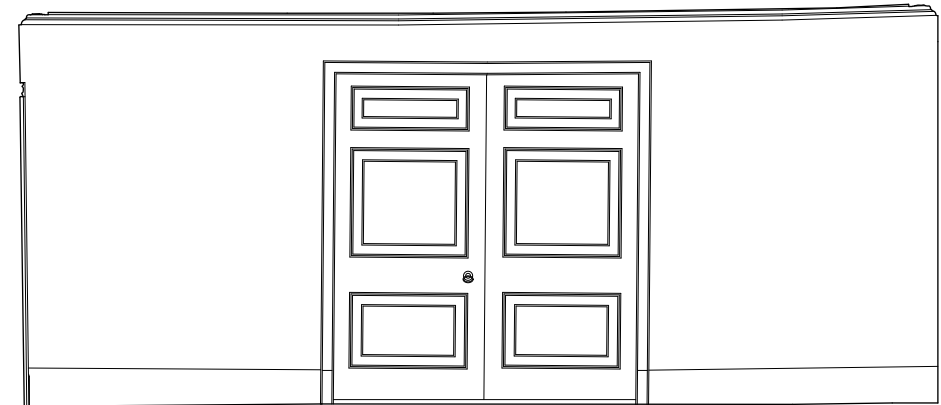

Elevation 4

**7 PILGRIMS LANE**

Studio Bernadeta  
AF Architects

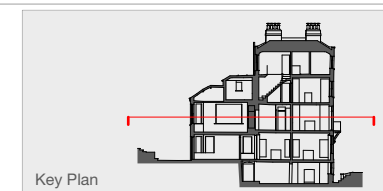

Key Plan

Project	037_7 PILGRIMS LANE
Drawing No.	037_PR.03_RM.01.02
Drawing Title	PR. FIRST FL._RM.02
Issue	17.01.25
Project No.	037
Scale/Format	1:100 @ A3
Date	JANUARY 2025

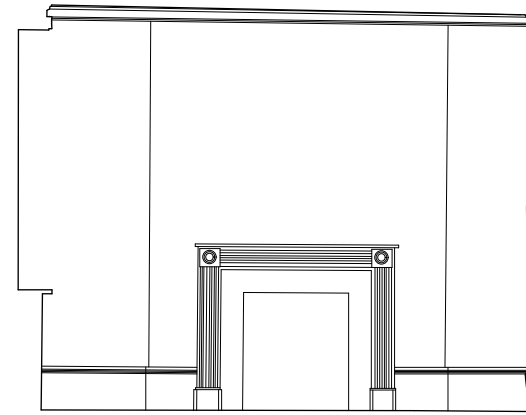

Elevation 1

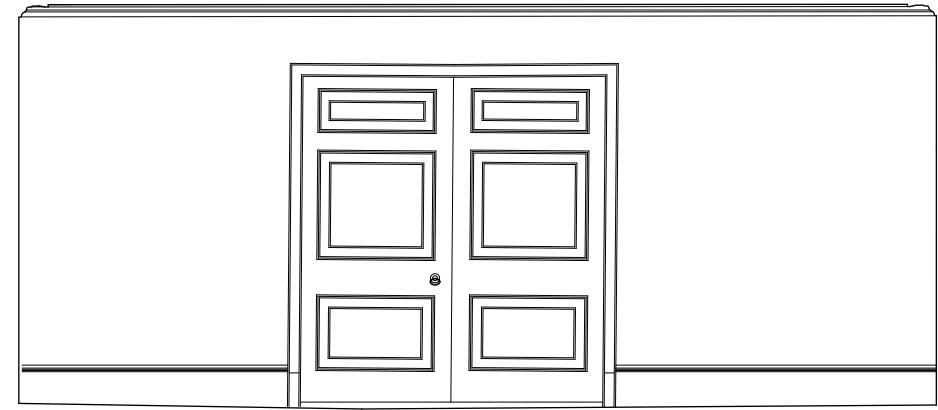

Elevation 2

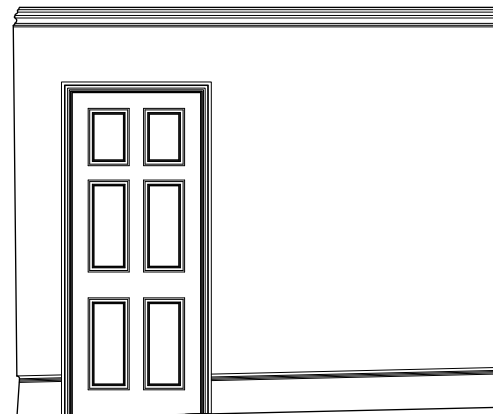
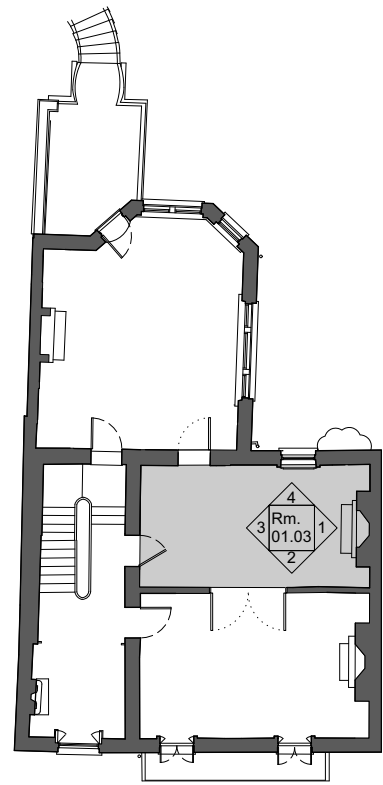

Elevation 3

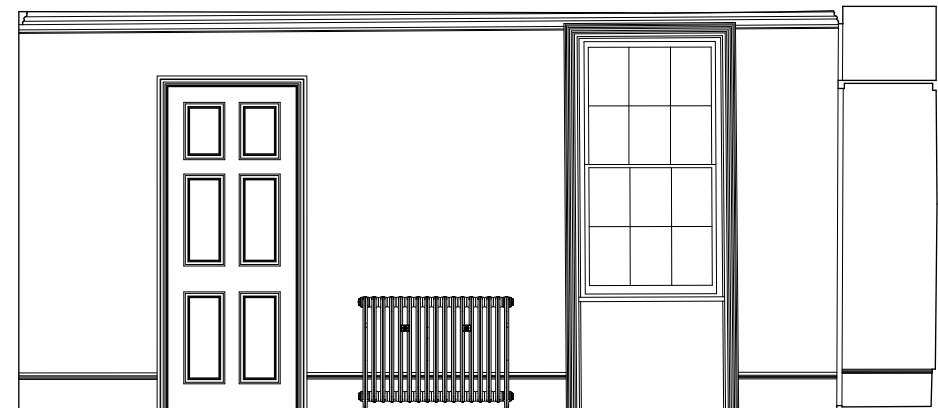

Elevation 4

**7 PILGRIMS LANE**

Studio Bernadeta  
AF Architects

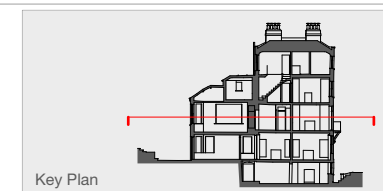

Key Plan

Project	037_7 PILGRIMS LANE
Drawing No.	037_PR.03_RM.01.03
Drawing Title	PR. FIRST FL._RM.03
Issue	17.01.25
Project No.	037
Scale/Format	1:100 @ A3
Date	JANUARY 2025

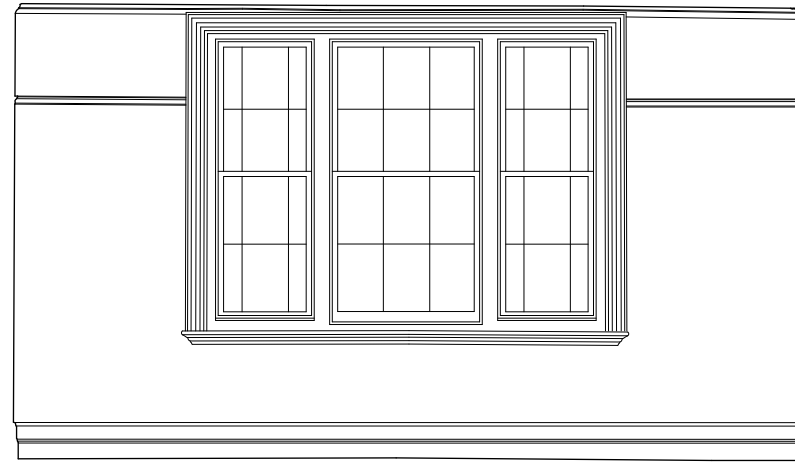

Elevation 1

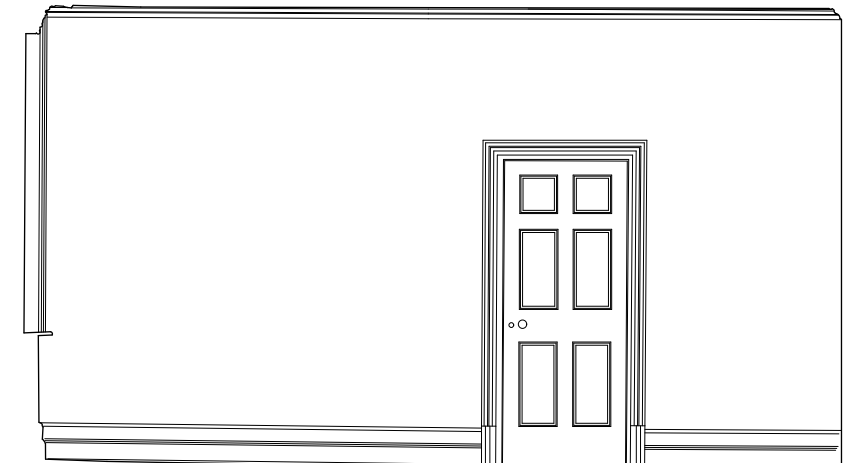

Elevation 2

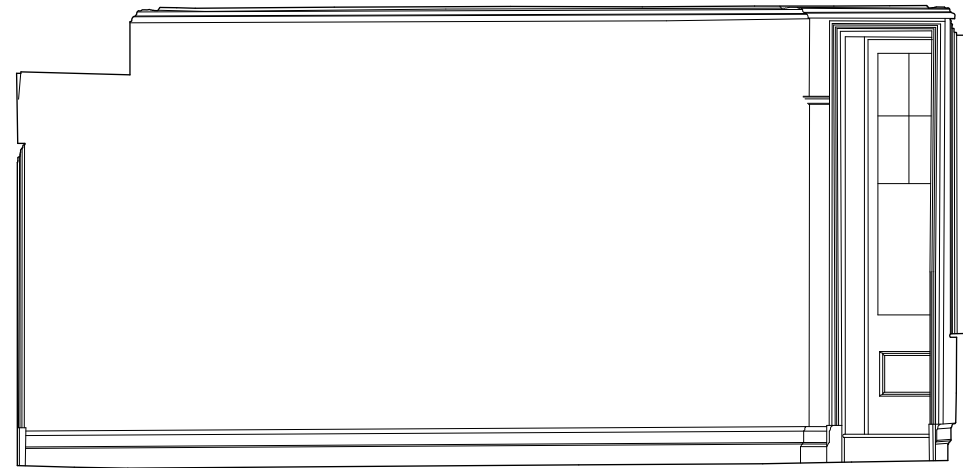
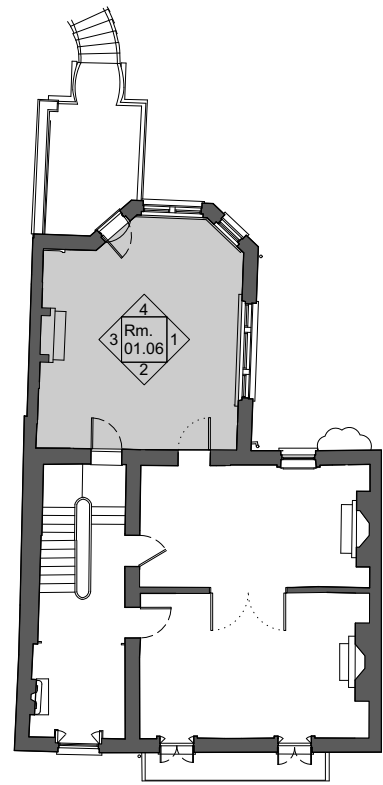

Elevation 3



Elevation 4

**7 PILGRIMS LANE**

Studio Bernadeta  
AF Architects

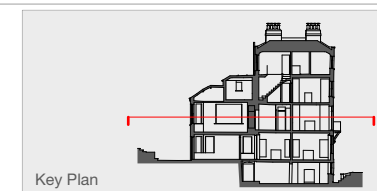

Key Plan

Project	037_7 PILGRIMS LANE
Drawing No.	037_PR.03_RM.01.06
Drawing Title	PR. FIRST FL._RM.06
Issue	17.01.25
Project No.	037
Scale/Format	1:100 @ A3
Date	JANUARY 2025

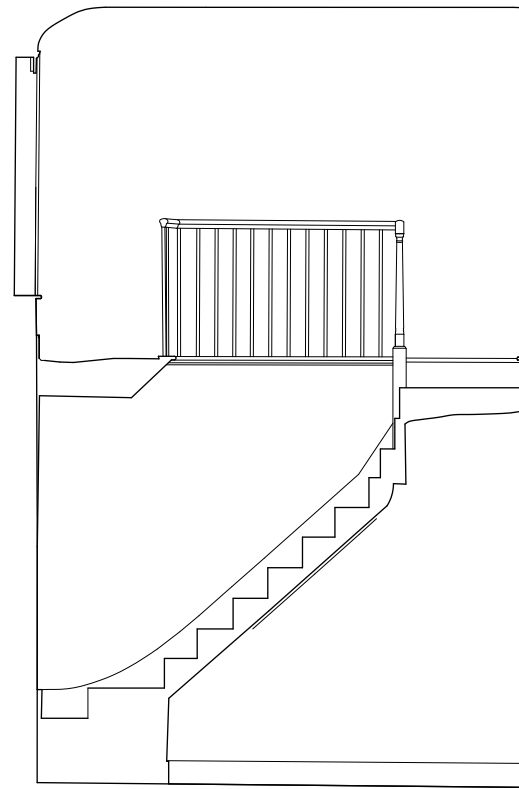
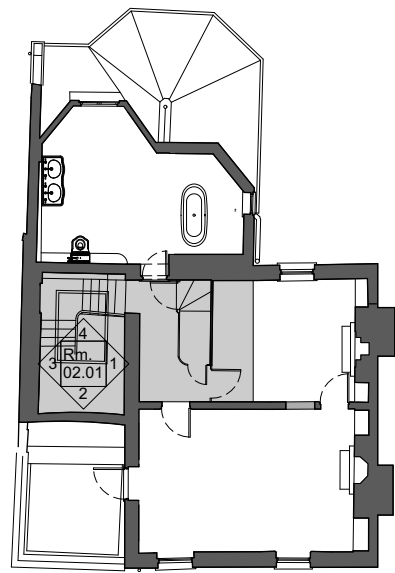

Elevation 1

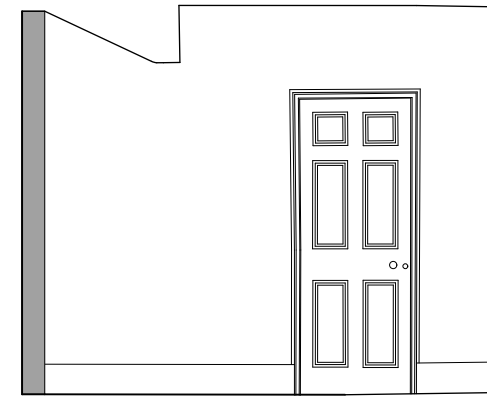

Elevation 2

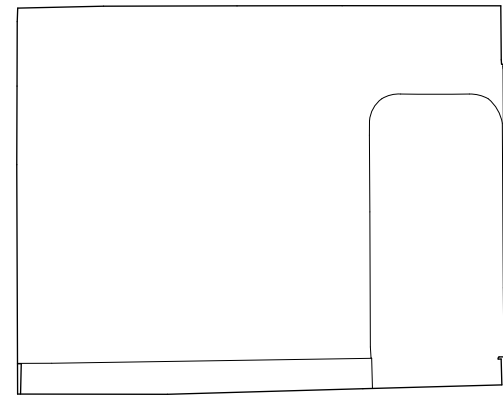

Elevation 3

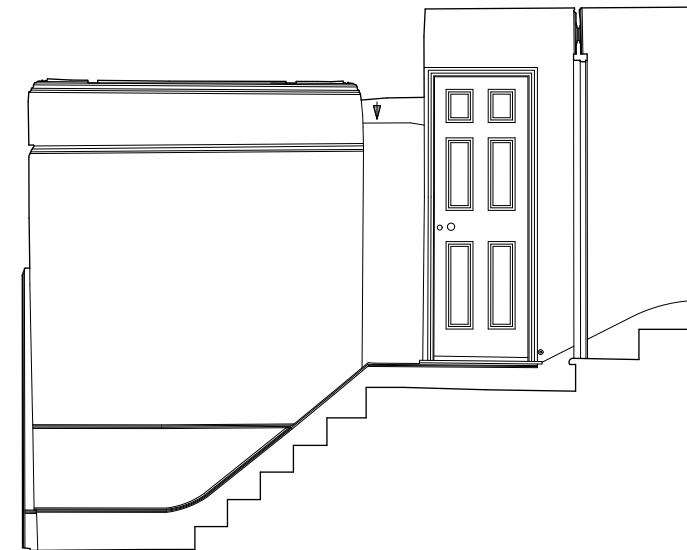

Elevation 4

**7 PILGRIMS LANE**

Studio Bernadeta  
AF Architects

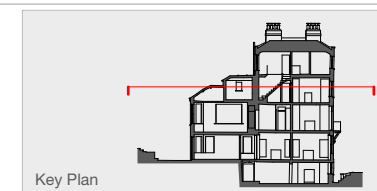

Key Plan

Project	037_7 PILGRIMS LANE
Drawing No.	037_PR.04_RM.02.01
Drawing Title	PR. SECOND FL._RM.01
Issue	17.01.25
Project No.	037
Scale/Format	1:100 @ A3
Date	JANUARY 2025

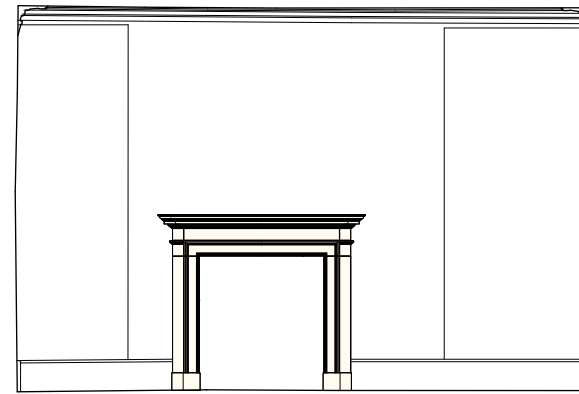

Elevation 1

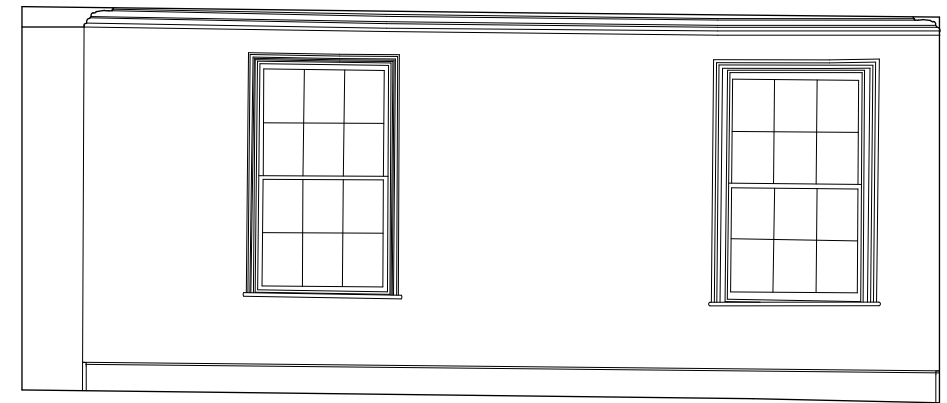

Elevation 2

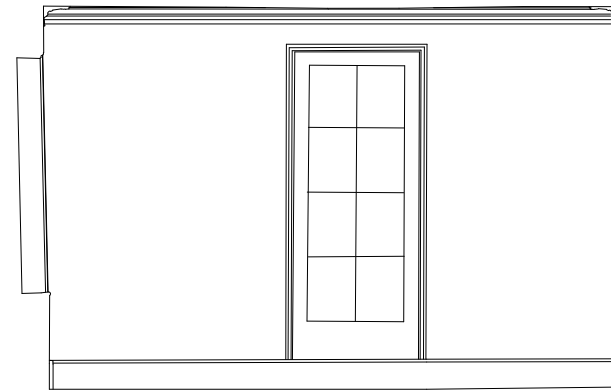
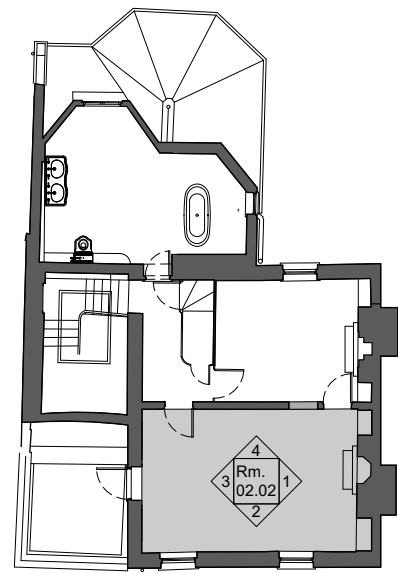

Elevation 3

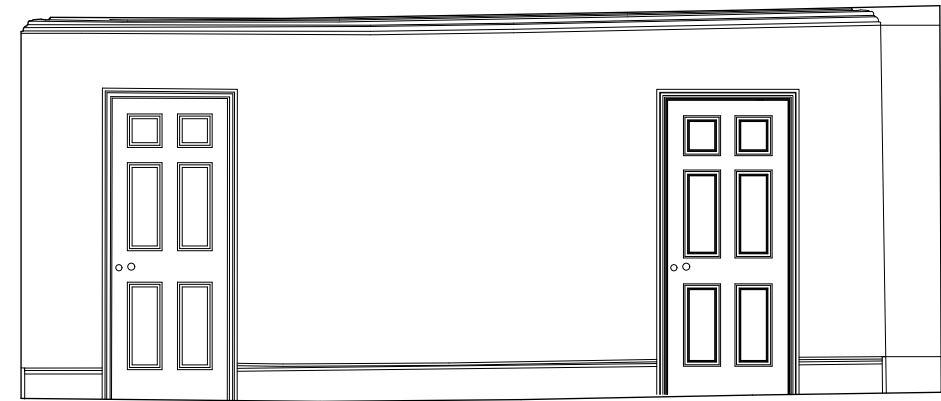

Elevation 4

**7 PILGRIMS LANE**

Studio Bernadeta  
AF Architects

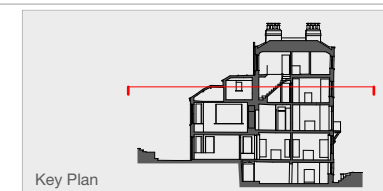

Key Plan

Project	037_7 PILGRIMS LANE
Drawing No.	037_PR.04_RM.02.02
Drawing Title	PR. SECOND FL._RM.02
Issue	17.01.25
Project No.	037
Scale/Format	1:100 @ A3
Date	JANUARY 2025

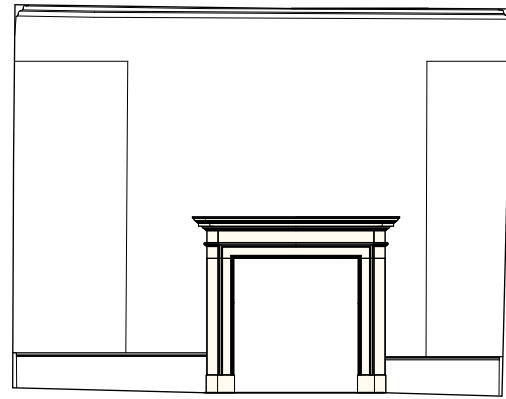

Elevation 1

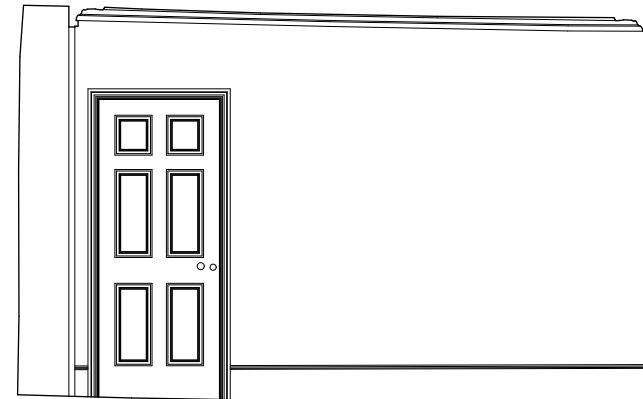

Elevation 2

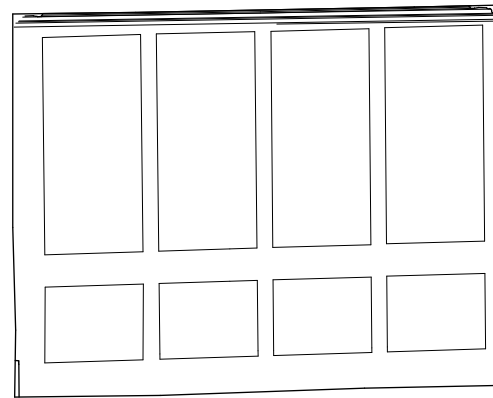
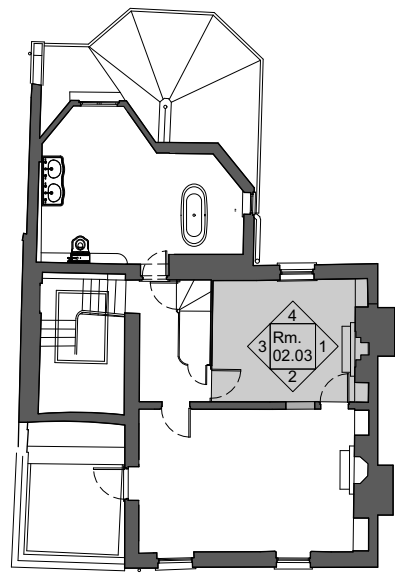

Elevation 3

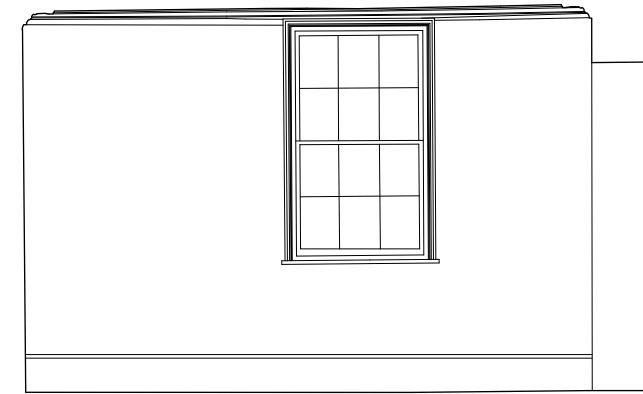

Elevation 4

**7 PILGRIMS LANE**

Studio Bernadeta  
AF Architects

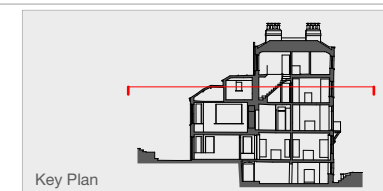

Key Plan

Project	037_7 PILGRIMS LANE
Drawing No.	037_PR.04 RM.02.03
Drawing Title	PROP. SECOND FL._RM.03
Issue	17.01.25
Project No.	037
Scale/Format	1:100 @ A3
Date	JANUARY 2025

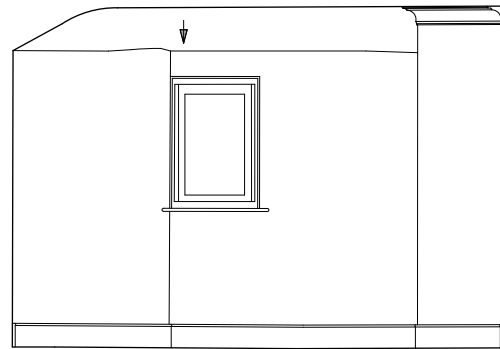

Elevation 1

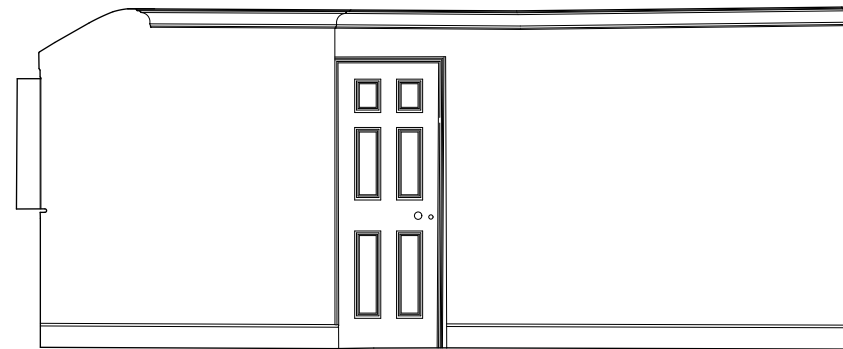

Elevation 2

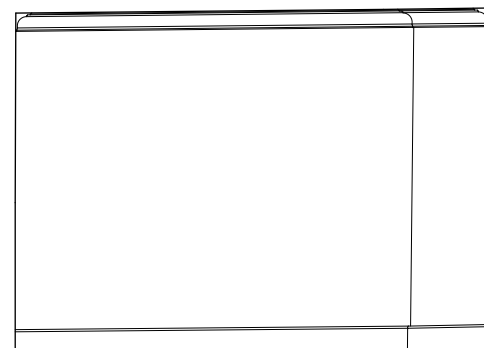
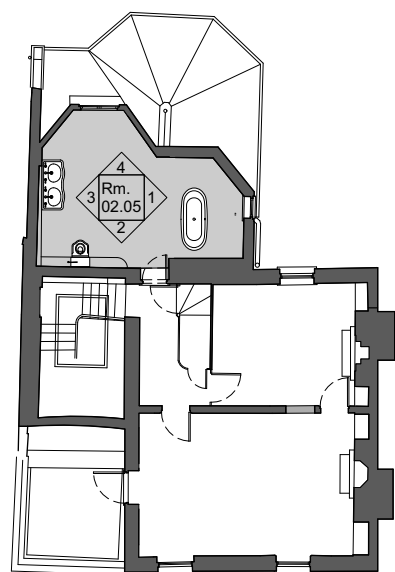

Elevation 3

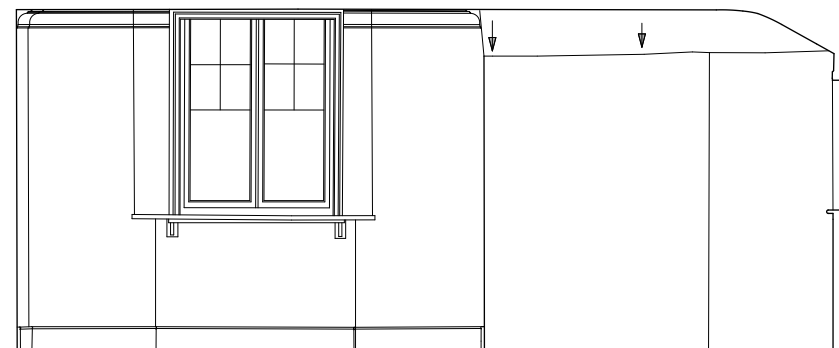

Elevation 4

**7 PILGRIMS LANE**

Studio Bernadeta  
AF Architects

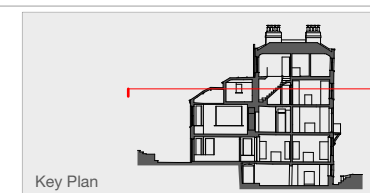

Key Plan

Project 037\_7 PILGRIMS LANE  
 Drawing No. 037\_PR.04\_RM.02.05  
 Drawing Title PR. SECOND FL.\_RM.05  
 Issue 17.01.25  
 Project No. 037  
 Scale/Format 1:100 @ A3  
 Date JANUARY 2025

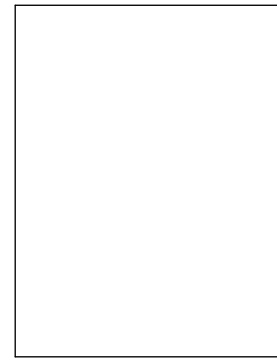

Elevation 1

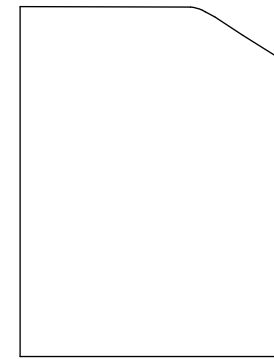

Elevation 2

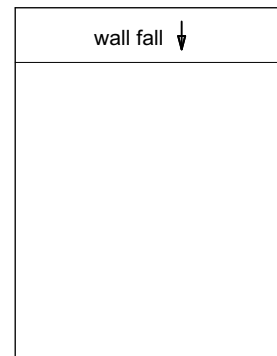
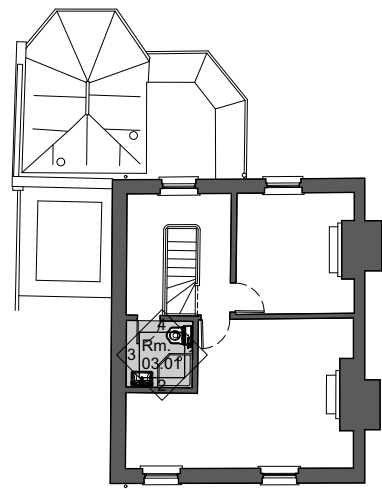

Elevation 3

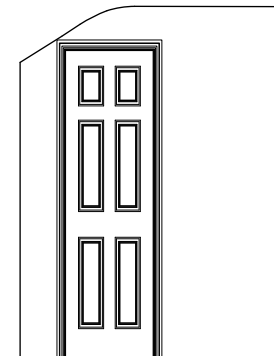

Elevation 4

## 7 PILGRIMS LANE

Studio Bernadeta  
AF Architects

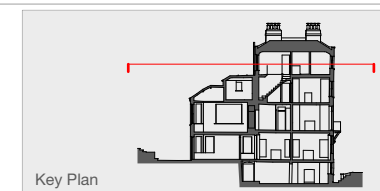

Key Plan

Project	037_7 PILGRIMS LANE
Drawing No.	037_PR.05_RM.03.01
Drawing Title	PR. THIRD FL._RM.01
Issue	17.01.25
Project No.	037
Scale/Format	1:100 @ A3
Date	JANUARY 2025



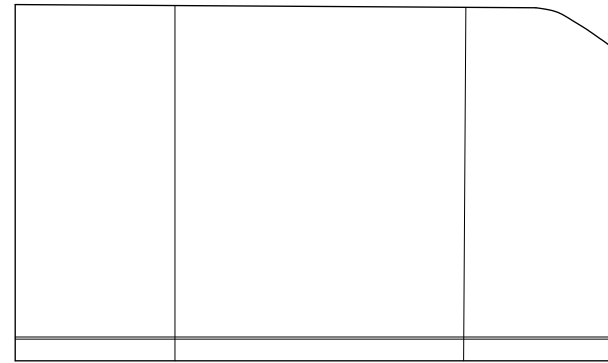

Elevation 1

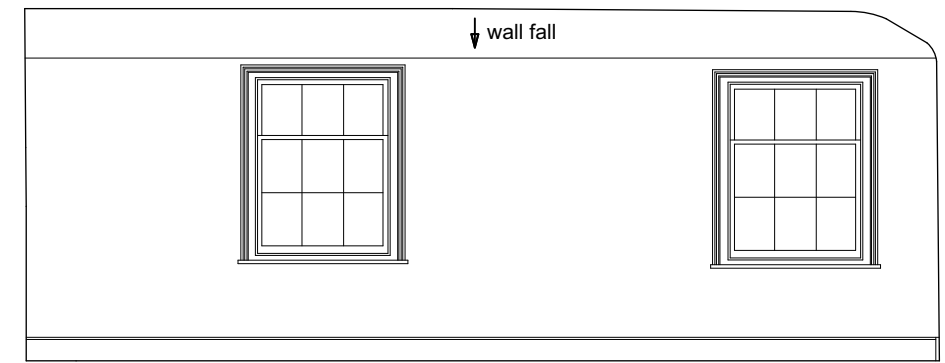

Elevation 2

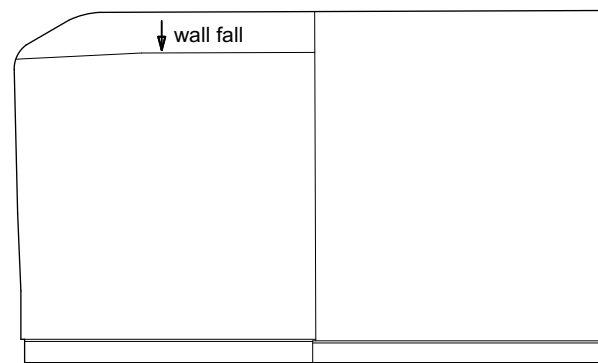
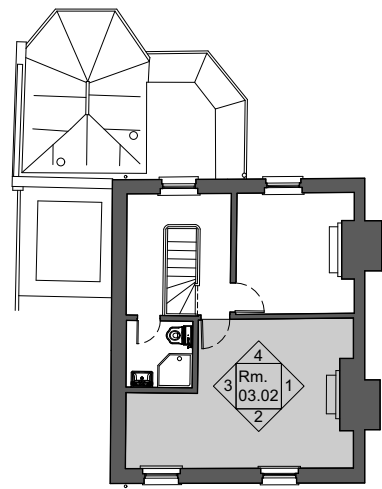

Elevation 3

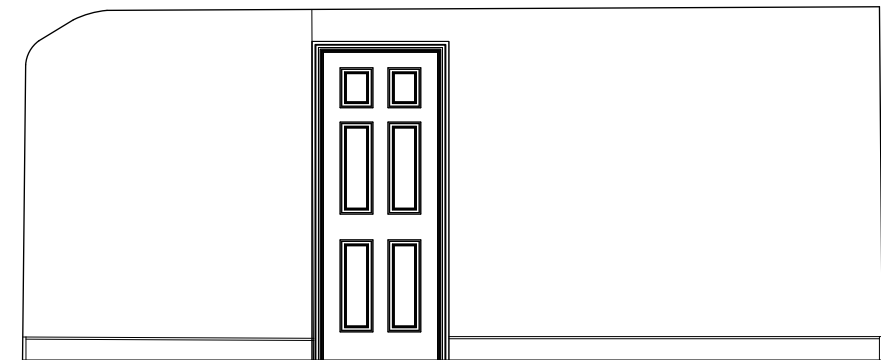

Elevation 4

**7 PILGRIMS LANE**

Studio Bernadeta  
AF Architects

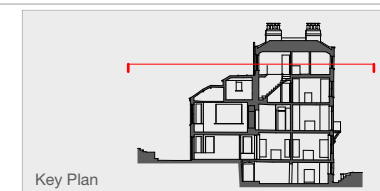

Key Plan

Project 037\_7 PILGRIMS LANE  
 Drawing No. 037\_PR.05\_RM.03.02  
 Drawing Title PR. THIRD FL.\_RM.02  
 Issue 17.01.25  
 Project No. 037  
 Scale/Format 1:100 @ A3  
 Date JANUARY 2025

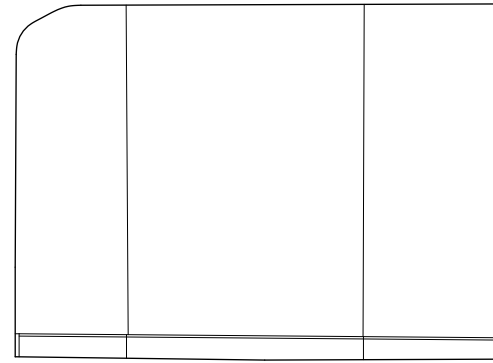

Elevation 1

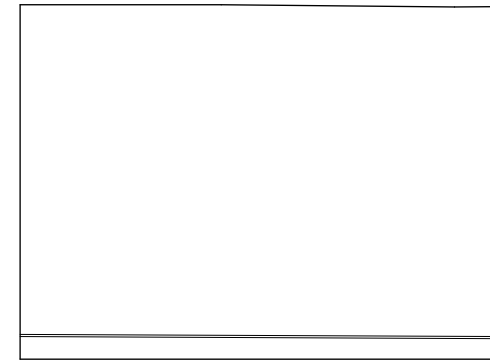

Elevation 2

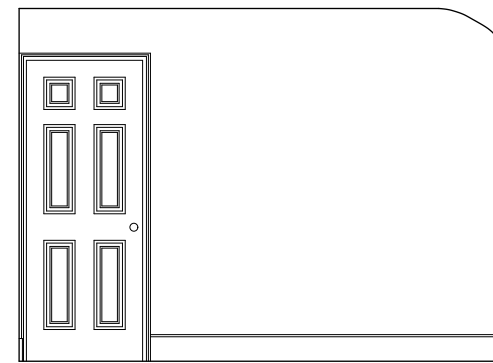
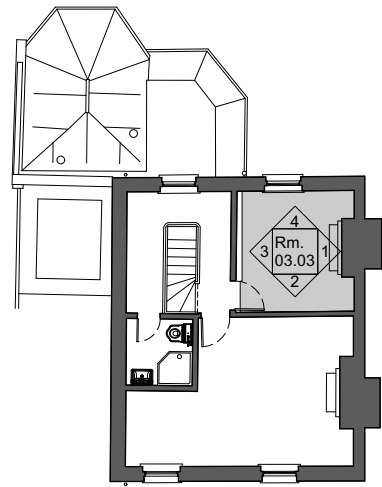

Elevation 3

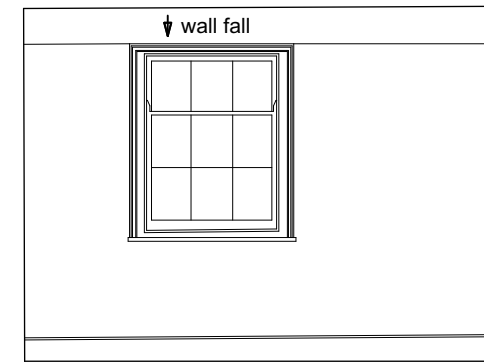

Elevation 4

**7 PILGRIMS LANE**

Studio Bernadeta  
AF Architects

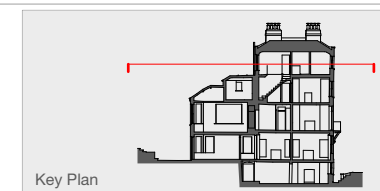

Key Plan

Project 037\_7 PILGRIMS LANE  
 Drawing No. 037\_PR.05\_RM.03.03  
 Drawing Title PR. THIRD FL.\_RM.03  
 Issue 17.01.25  
 Project No. 037  
 Scale/Format 1:100 @ A3  
 Date JANUARY 2025