

external view

01 Front view
C (51)005 1:20@A3

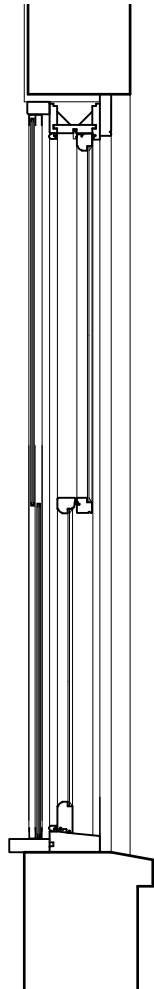

03 Section
C (51)005 1:20@A3

Secondary glazing to be fitted to existing window

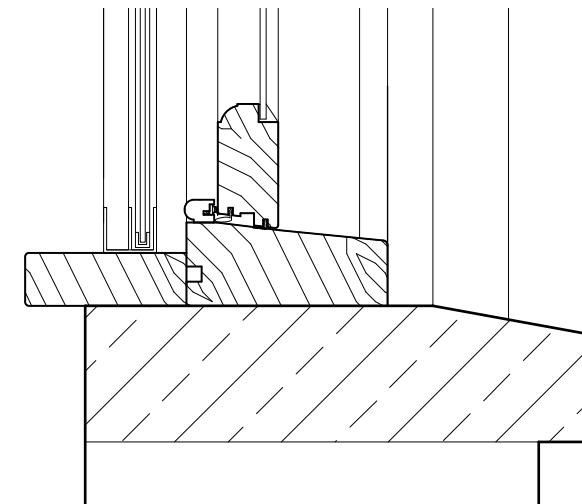
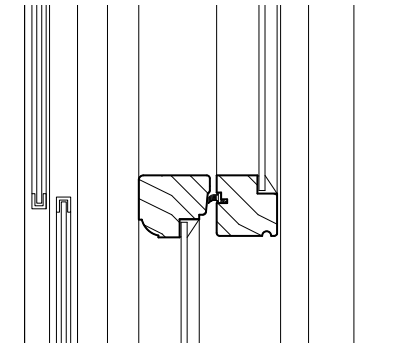
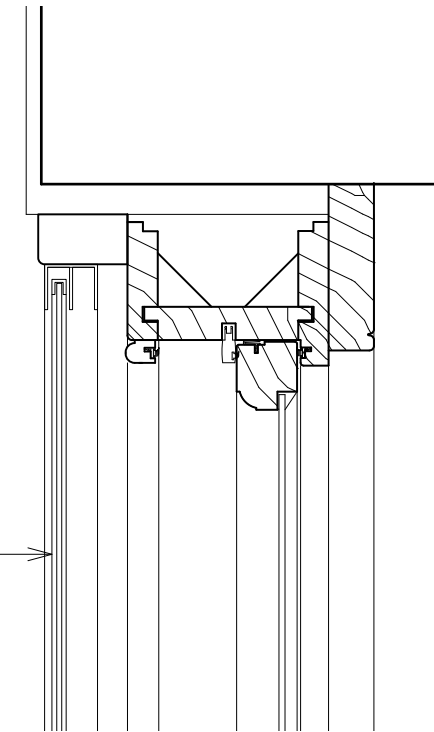

05 Section detail
C (51)005 1:5@A3

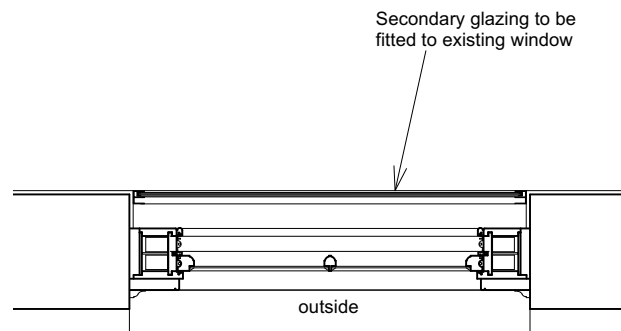

02 Plan
C (51)005 1:20@A3

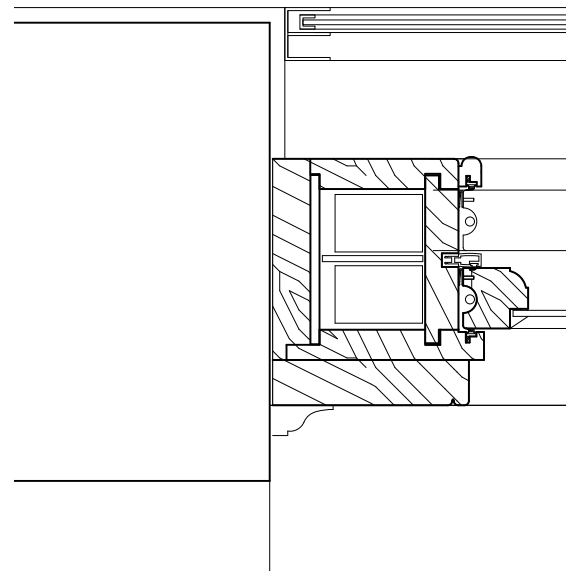

04 Jamb detail
C (51)005 1:5@A3

Notes

Revisions

PLANNING

51 Great Ormond Street
London, WC1N 3HZ

Details - Proposed Secondary Glazing
Rear windows

ROGER MEARS ARCHITECTS LLP
Union Chapel, Compton Avenue London N1 2XD

rma@rmears.co.uk
www.rmears.co.uk

tel 020 7359 8222
© Roger Mears Architects LLP

Date 05/04/2024	Scale 1:5@A3	
Job No. 2203	Dwg No. C (51)005	Rev