

W 01

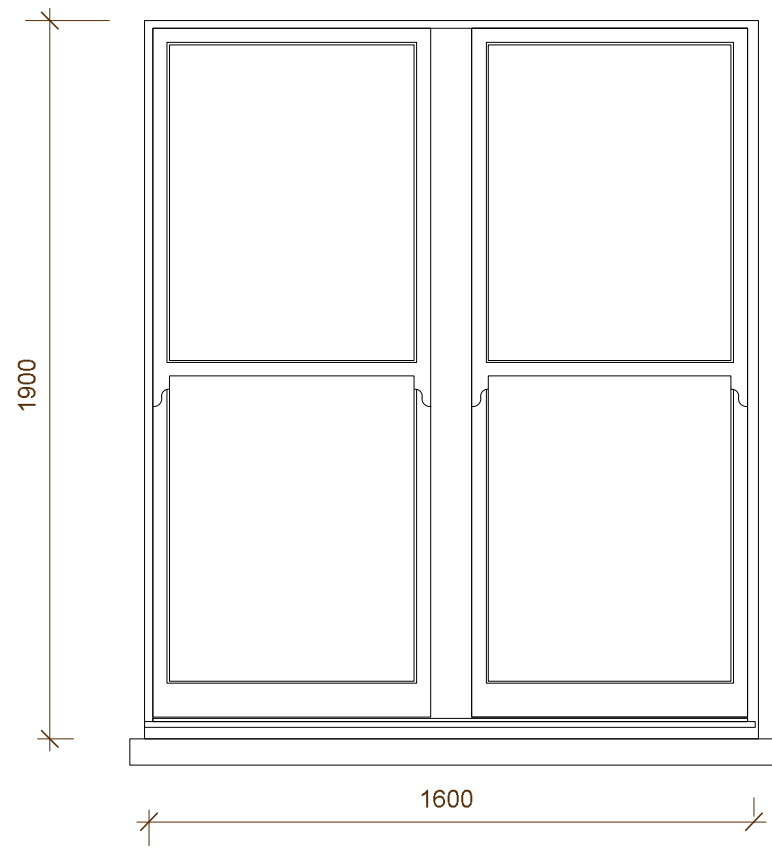

EXTERNAL ELEVATION

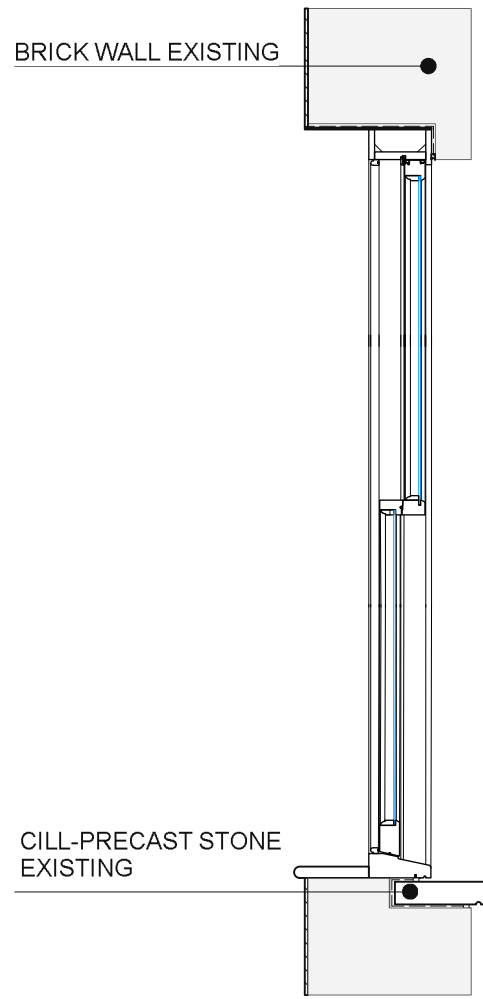

SECTION

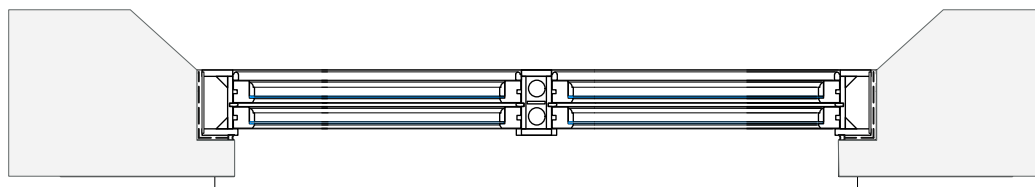

PLAN

W 02

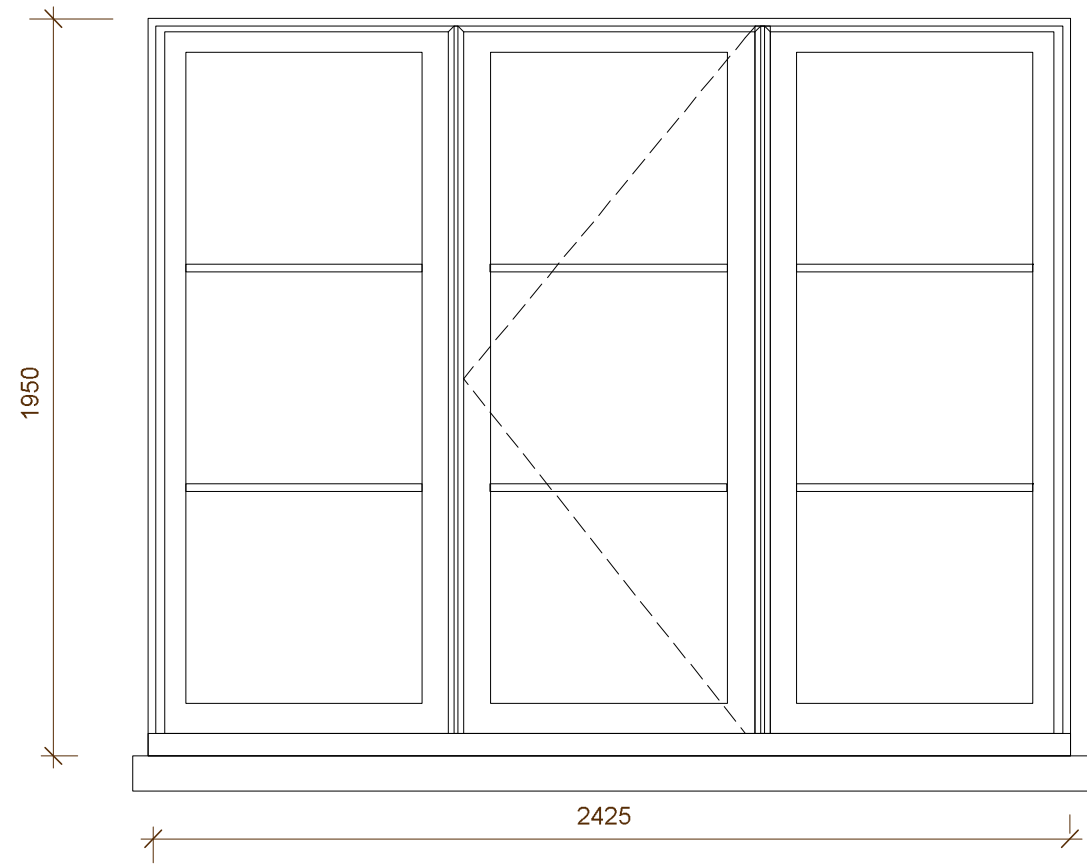

EXTERNAL ELEVATION

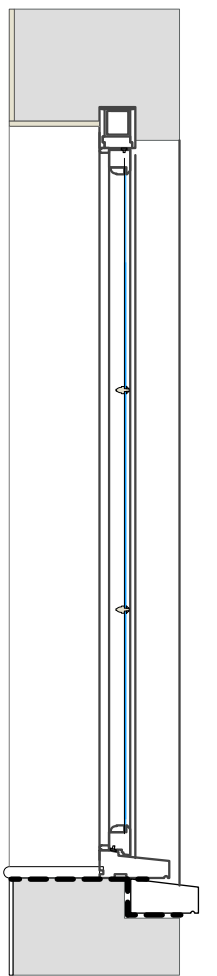

SECTION

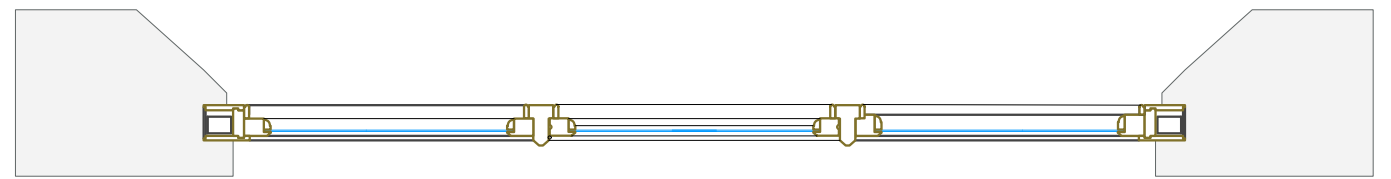

PLAN

WINDOW DETAIL W01 & W02
TD:W:001

drawing title Windows				do not scale dimension from this drawing. all measurements given are indicative. all dimensions to be determined on site prior to purchase and manufacture. all discrepancies between indicative dimensions and those measured on site to be brought to the architect's attention. this drawing is copyright and should not be copied or duplicated in anyway without the consent of the architect.
Proposed				
project 2 Villas on the Heath Hampstead NW3 1BA	status Planning	project No 952 drawing No TD'W001 revision	date 02/24 scale 1:20	

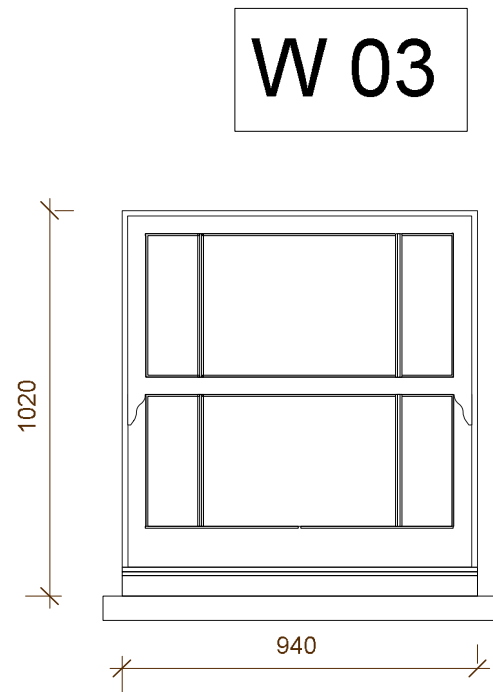

EXTERNAL ELEVATION

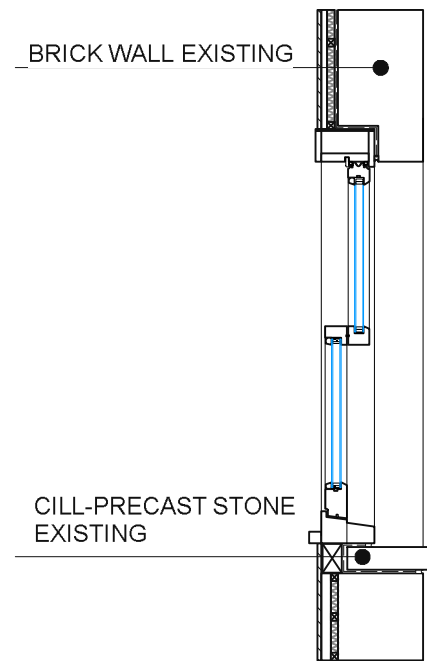

SECTION

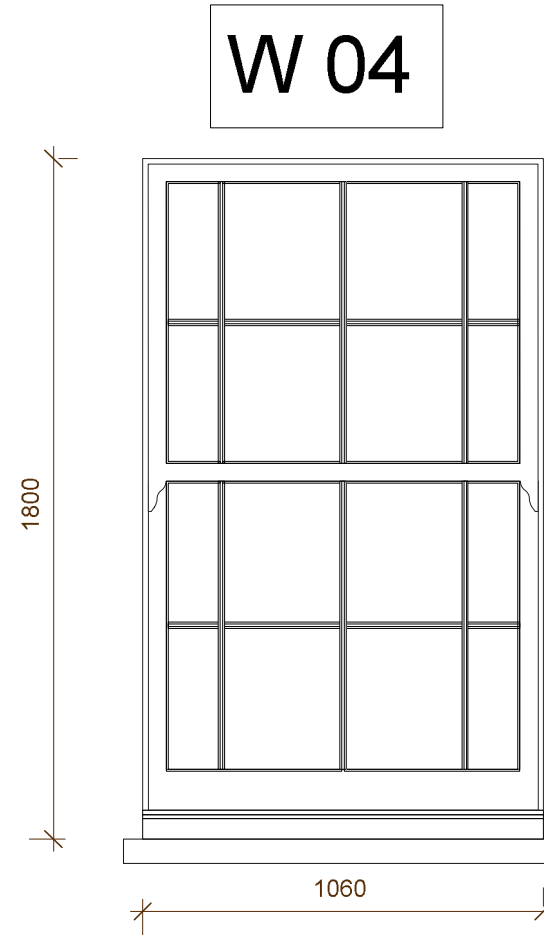

EXTERNAL ELEVATION

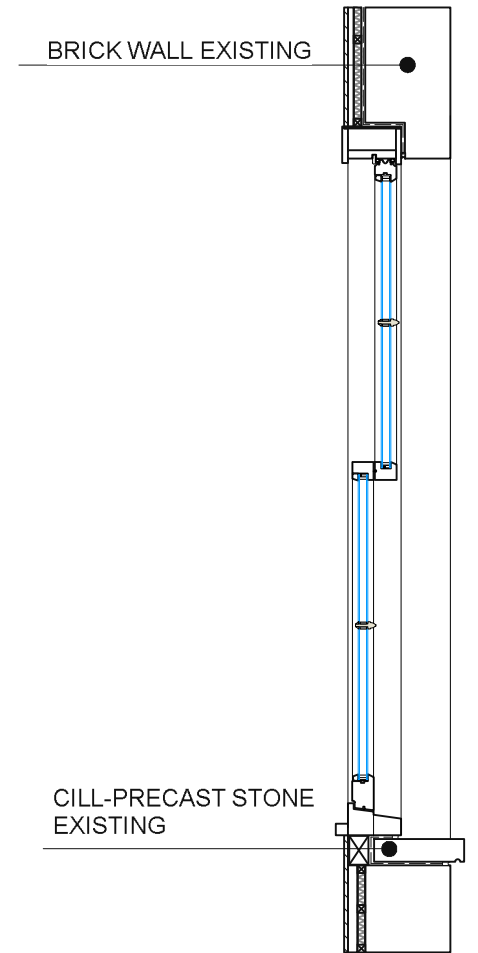

SECTION

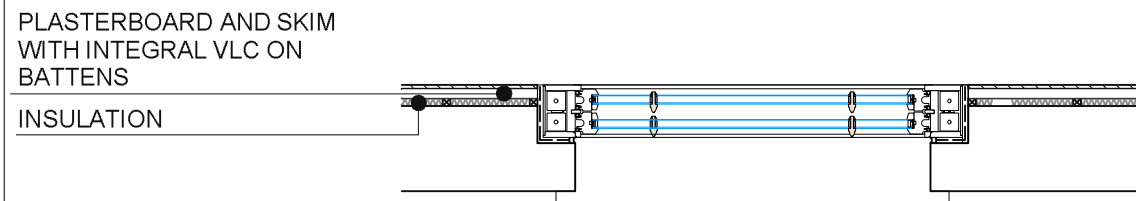

PLAN

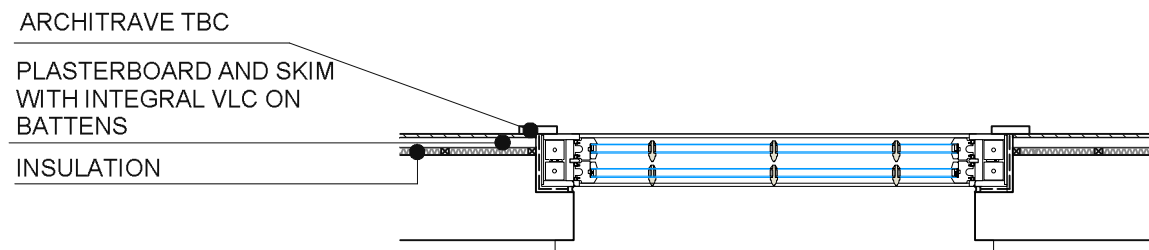

PLAN

WINDOW DETAIL W03 & W04
TD:W:003

drawing title Windows				do not scale dimension from this drawing. all measurements given are indicative. all dimensions to be determined on site prior to purchase and manufacture. all discrepancies between indicative dimensions and those measured on site to be brought to the architect's attention. this drawing is copyright and should not be copied or duplicated in anyway without the consent of the architect.
Proposed				
project 2 Villas on the Heath Hampstead NW3 1BA	status Planning	project No 952 drawing No TD'W003 revision	date 02/24 scale 1:20	

W 06

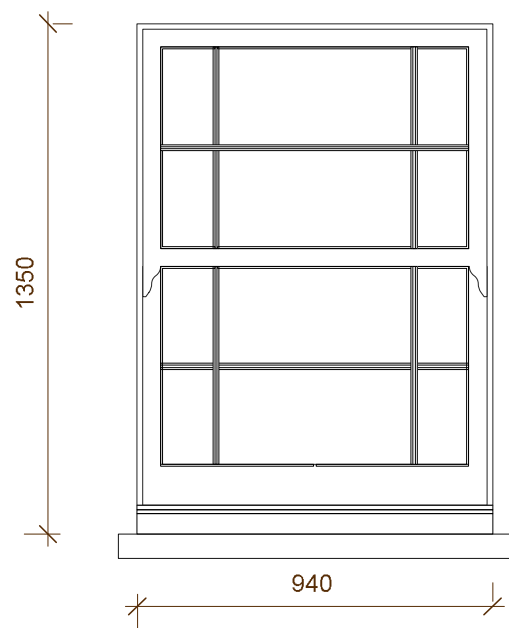

EXTERNAL ELEVATION

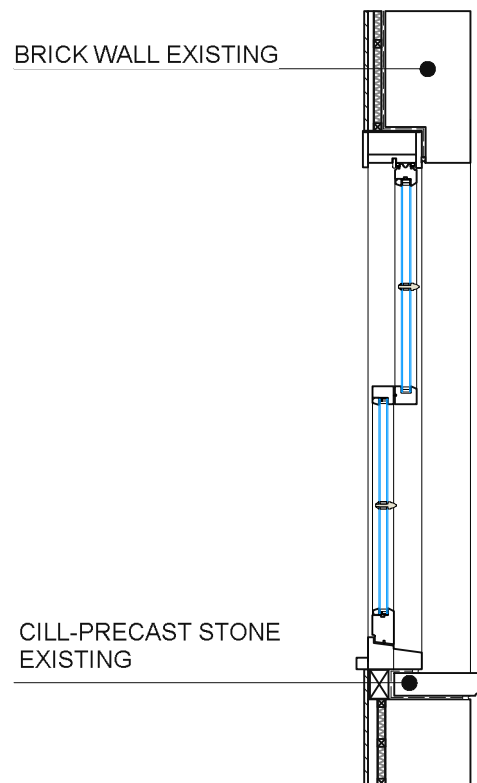

SECTION

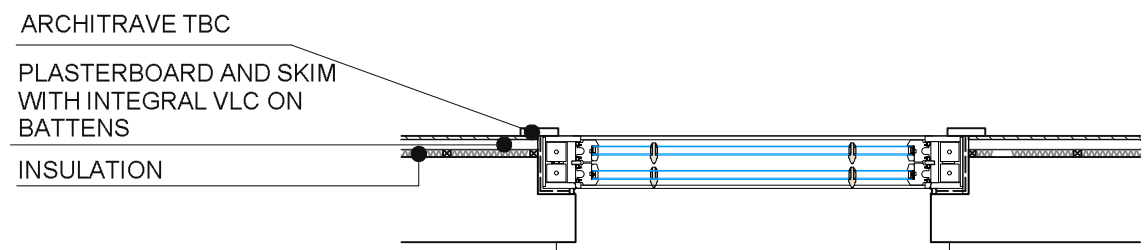

PLAN

W 07

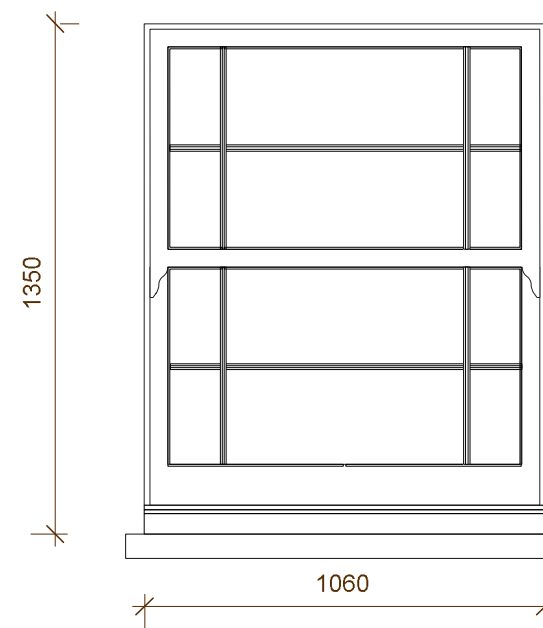

EXTERNAL ELEVATION

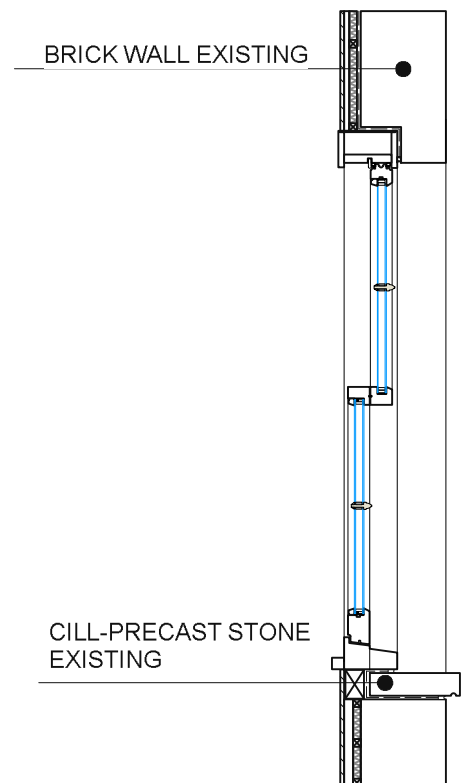

SECTION

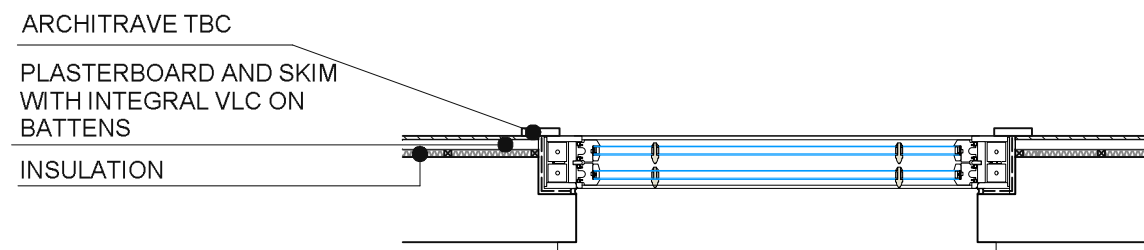

PLAN

WINDOW DETAIL W06 & W07
TD:W:004

drawing title Windows Proposed	status Planning	project No 952 drawing No TD'W004 revision	date 02/24 scale 1:20	do not scale dimension from this drawing. all measurements given are indicative. all dimensions to be determined on site prior to purchase and manufacture. all discrepancies between indicative dimensions and those measured on site to be brought to the architect's attention. this drawing is copyright and should not be copied or duplicated in anyway without the consent of the architect.
--------------------------------------	--------------------	--	--------------------------	---

W 08

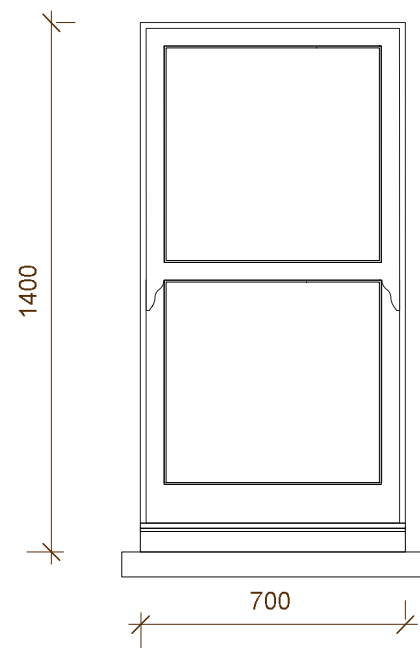

EXTERNAL ELEVATION

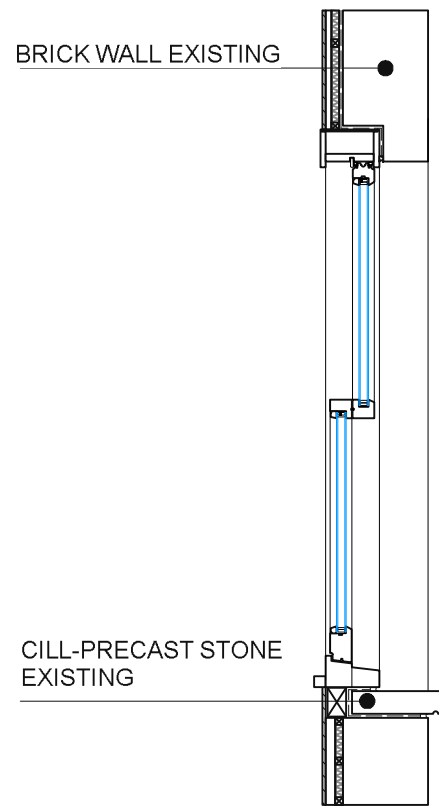

W 09

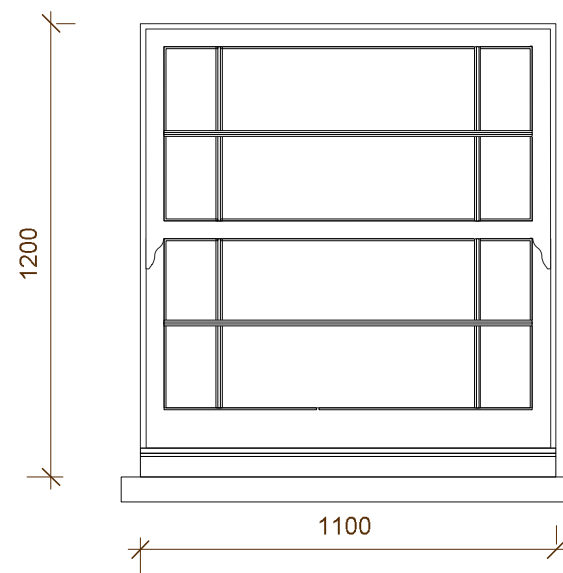

EXTERNAL ELEVATION

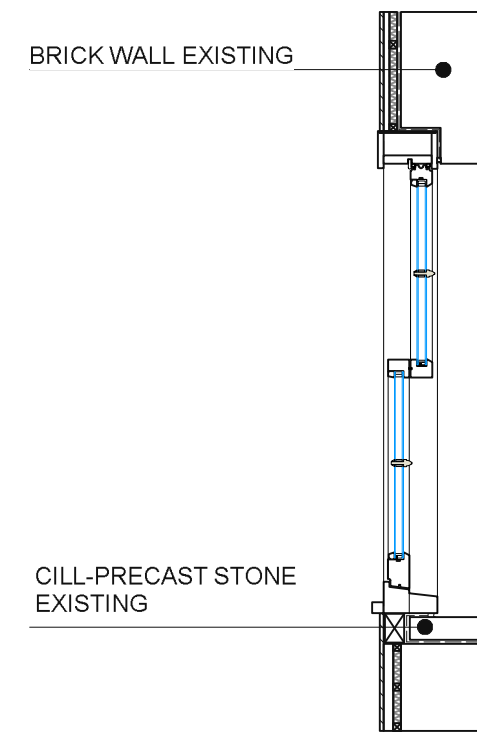

SECTION

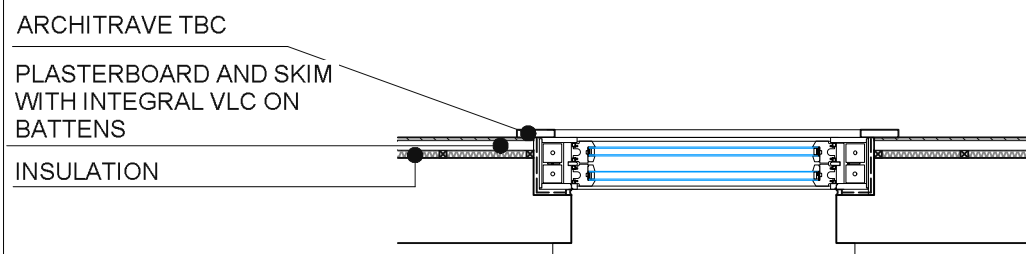

PLAN

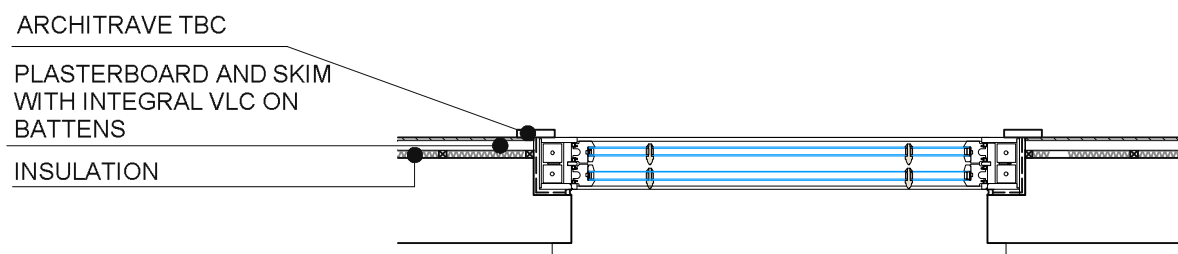

PLAN

WINDOW DETAIL W08 & W09
TD:W:005

drawing title Windows				do not scale dimension from this drawing. all measurements given are indicative. all dimensions to be determined on site prior to purchase and manufacture. all discrepancies between indicative dimensions and those measured on site to be brought to the architect's attention. this drawing is copyright and should not be copied or duplicated in anyway without the consent of the architect.
Proposed				
project 2 Villas on the Heath Hampstead NW3 1BA	status Planning	project No 952 drawing No TD'W005 revision	date 02/24 scale 1:20	

W 05

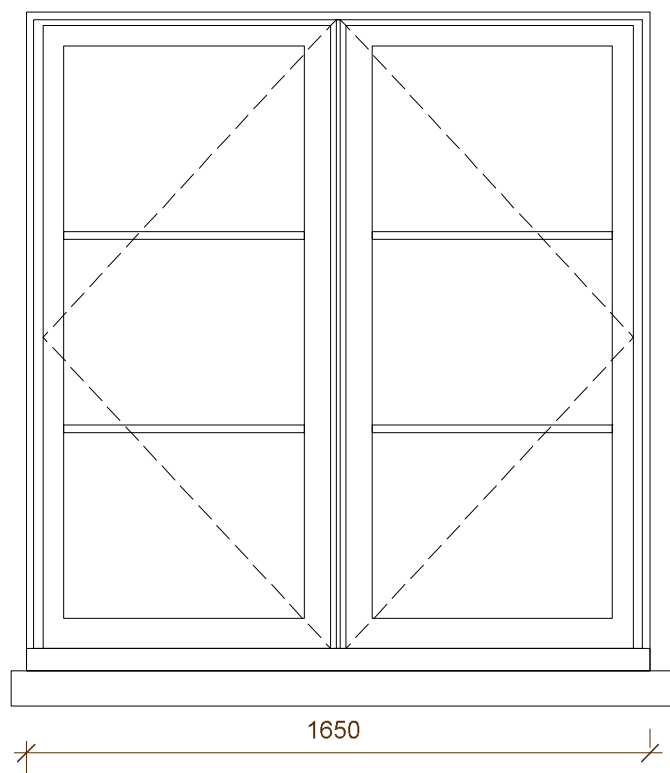

EXTERNAL ELEVATION

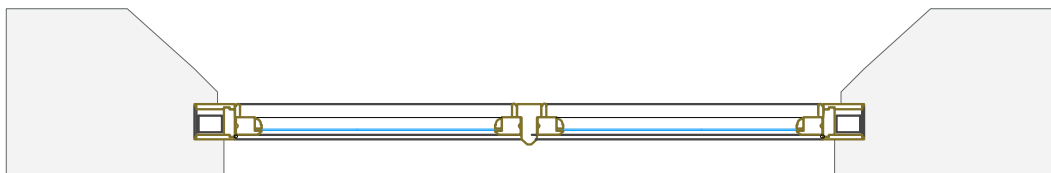

PLAN

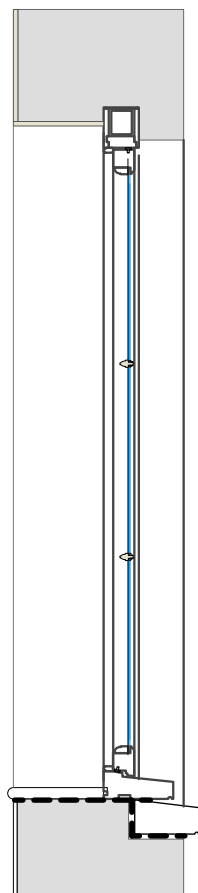

SECTION

W 10

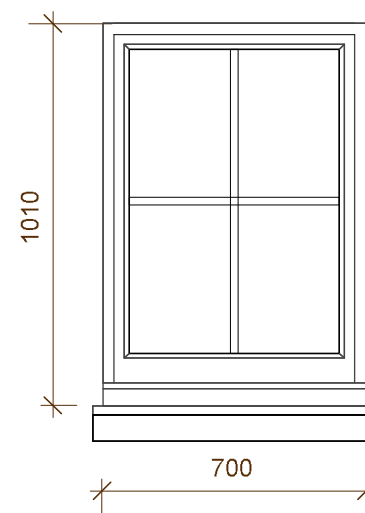

EXTERNAL ELEVATION

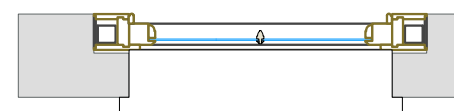

PLAN

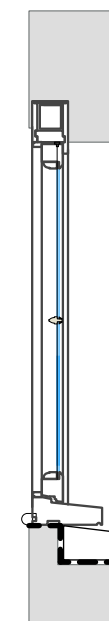

SECTION

WINDOW DETAIL W05 & W10
TD:W:002

drawing title Windows Proposed				do not scale dimension from this drawing. all measurements given are indicative. all dimensions to be determined on site prior to purchase and manufacture. all discrepancies between indicative dimensions and those measured on site to be brought to the architect's attention. this drawing is copyright and should not be copied or duplicated in anyway without the consent of the architect.
project 2 Villas on the Heath Hampstead NW3 1BA	status Planning	project No 952 drawing No TD'W002 revision	date 02/24 scale 1:20	