

► **Katherm NK**
Trench Heating

Katherm NK

The Perfect Embodiment of Natural Convection

► **Technical Catalogue**

Contents

01 ▶ Product Information	6
▶ Overview _____	7
▶ Product Data _____	8
▶ Selection Assistance: Overview of Models _____	9
▶ Katherm NK at a Glance _____	10
▶ Grilles _____	12
▶ Katherm NK – supply air modules ZL _____	14
02 ▶ Technical Data	16
▶ Advice on Measuring Conditions _____	17
▶ Katherm NK 137, trench height 92 mm/120 mm _____	18
▶ Katherm NK 182, trench height 92 mm/120 mm/150 mm/200 mm _____	20
▶ Katherm NK 232, trench height 92 mm/120 mm/150 mm/200 mm _____	22
▶ Katherm NK 300, trench height 92 mm/120 mm/150 mm/200 mm _____	24
▶ Katherm NK 380, trench height 92 mm/120 mm/150 mm/200 mm _____	26
03 ▶ Design Information	28
▶ Information for Planning and Design _____	29
04 ▶ Control	30
▶ Electrical Control _____	30
05 ▶ Ordering Information	34
▶ Katherm NK _____	34
▶ Accessories _____	35



Katherm NK:
Optimised
performance with
a wide range of
dimensions



Porsche Centre, Moscow:
2,500 m² showroom in one of
Moscow's main traffic arteries –
fit-out for sales rooms and repair
workshop

01 ▶ Product Information



Katherm NK – high-performance, efficient, wide range

Heaters positioned in front of windows are often unacceptable for aesthetic reasons in modern offices and other buildings with large glazed windows. At the same time, the needs of the users of the space to the aesthetics of the space also increase.

Structurally improved thanks to measurements in Kampmann's R&D Centre, the Katherm NK is a trench heater with optimised performance and a greater range of standard units. The window-side arrangement of the convector ensures efficient screening of cold air with all trench widths.

Katherm NK trench heaters are installed either in screed or within a raised floor, depending on the desired height, underneath floor-to-ceiling glazing. High-output performance, even at low system temperatures, they are ideal at effectively screening

cold air, to supply supplementary heat or even to provide effective at in addition to more effectively or even as a complete space heating system.

Operation

Cooled air sinks into the floor trench, flows below or at the side of the water-heated convector, then through it and then rises as heated air towards the glazing. The warm air enters the room draught-free and falls to the ground when it cools, thereby producing gentle air recirculation in the room.

The silent operation of natural convection in the rooms also adds to the cosy 'feel good' climate in the room. The heat outputs are ideally adapted to the heat requirement, depending on the height and width.

Control

Optional electromechanical control is provided by the combination of a room thermostat and a clock thermostat, either surface-mounted or flush-mounted, with thermostatic valves and actuators.

Katherm NK 232

(Installed in screed, trench height 120 mm)

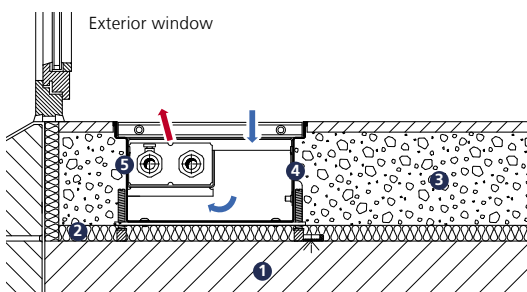

- 1 Concrete floor
- 2 Heat and sound insulation
- 3 Screed
- 4 Floor trench
- 5 Highoutput convector

Katherm NK 380

(Installed in the raised floor, trench height 200 mm)

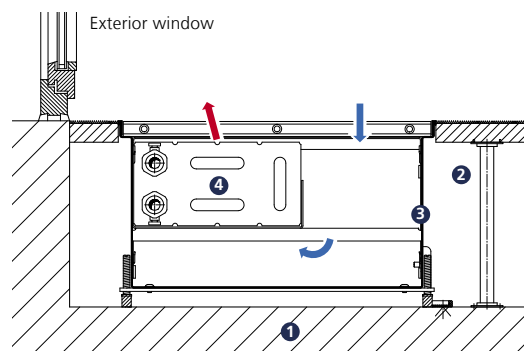

- 1 Concrete floor
- 2 False floor
- 3 Floor trench
- 4 Highoutput convector

Product Data



Product Features

- ▶ Particularly beneficial in modern buildings with large windows
- ▶ With natural convection for complete room heating, supplementary heating and/or cold air screening
- ▶ Adaptation of length by trench extensions provided by empty trenches or by coupling standard lengths together
- ▶ Convenient surface- or flush-mounted electrical controller



Features

Standard range

5 trench widths, 22 trench lengths, 4 trench heights. Notwithstanding the standard range (NP), the products can also be individually manufactured in line with the non-standard programme (MP).

- Convection** ▶ Natural
Heating ▶ LPHW
Cooling ▶ ---
Ventilation ▶ ---
KaControl System ▶ 2-pipe

Grille finishes

- ▶ Roll-up grilles
- ▶ Linear grilles

Performance data

Heat output¹⁾ [W]

- ▶ 78–5590

Uses

Cold air screening is specifically provided using the particular properties of natural convection: optimum in rooms in which no free-standing heaters are possible for visual reasons.



Hotels/
motels



Sales rooms
and
showrooms



Office and
meeting
rooms



Residential
areas and
conservatories



Restaurants
and cafés

¹⁾ at LPHW 75/65, $t_{L1}=20^{\circ}\text{C}$

Selection Assistance: Overview of Models

Model	Trench width	Trench height	Trench length (200 mm increment)	Heat output ¹⁾	Further information
	[mm]	[mm]	[mm]	[W]	
NK 137	137	92	800–5000	78–1050	▶ Page 16
		120			
NK 182	182	92	800–5000	132–2084	▶ Page 18
		120			
		150			
		200			
NK 232	232	92	800–5000	157–3010	▶ Page 20
		120			
		150			
		200			
NK 300	300	92	800–5000	209–4003	▶ Page 22
		120			
		150			
		200			
NK 380	380	92	800–5000	279–5590	▶ Page 24
		120			
		150			
		200			

Cross-sectional views (Trench height 120 mm)

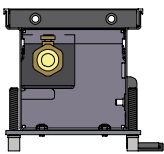

Katherm NK 137

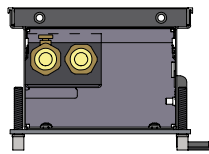

Katherm NK 182

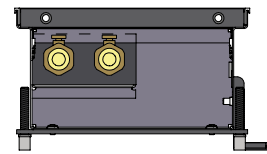

Katherm NK 232

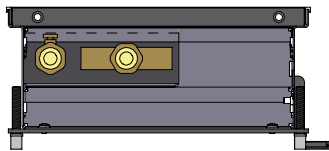

Katherm NK 300

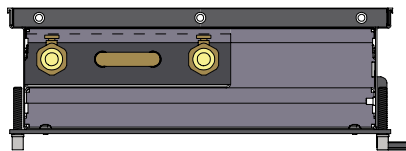

Katherm NK 380

¹⁾ at LPHW 75/65, t_l=20°C, heat outputs in compliance with DIN EN 16430 Parts 1 and 2

Katherm NK at a Glance

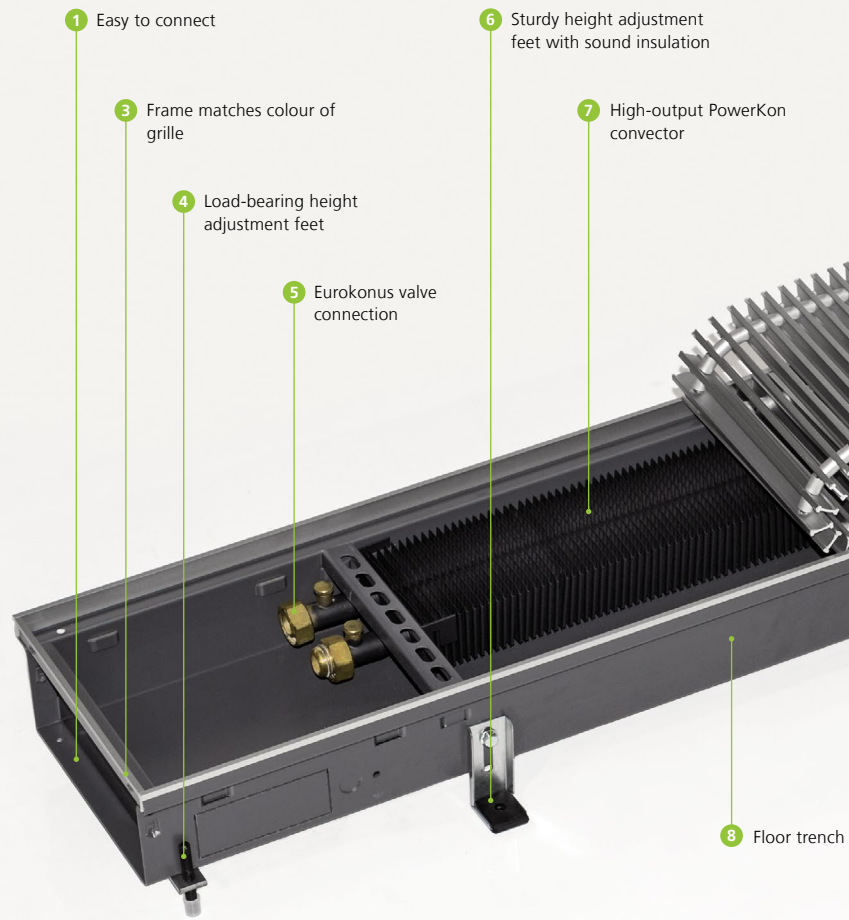

Features:

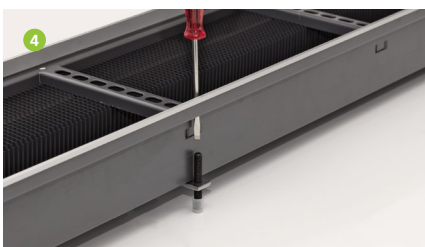
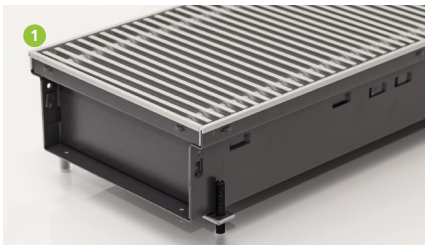

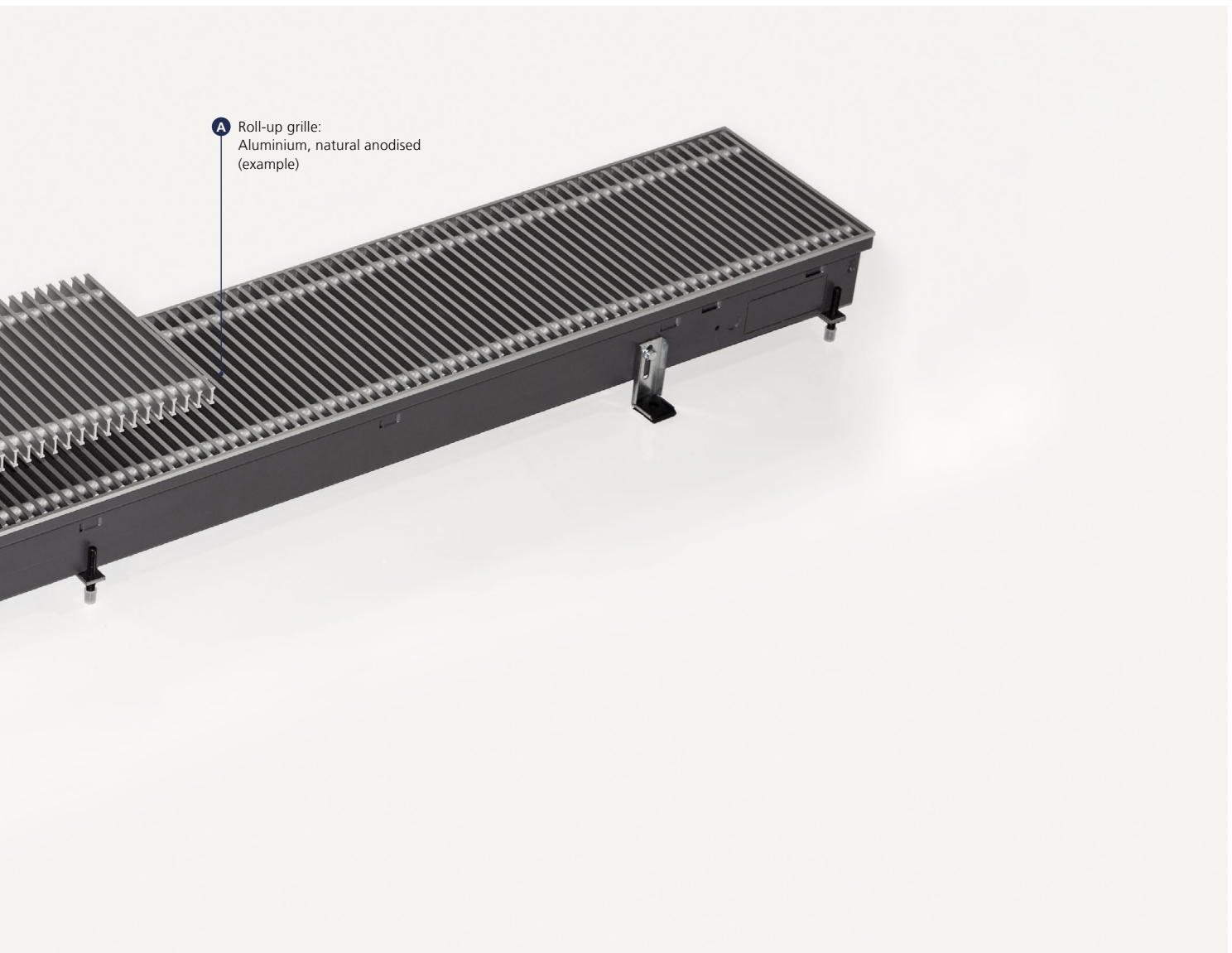

A Roll-up grille:
Aluminium, natural anodised
(example)

- 1 Easy to connect:**
 - ▶ Removable end panel for ease of connection of trenches
- 2 Cover plate:**
 - ▶ As visual protection and to protect against dirt
- 3 Frame matches colour of grille**
- 4 Load-bearing height adjustment feet:**
 - ▶ for the safe mounting of the trench
 - ▶ as standard
- 5 Eurokonus valve connection:**
 - ▶ For fast connection
 - ▶ Saves installation time
- 6 Sturdy height adjustment feet with sound insulation:**
 - ▶ For simple fixing of the floor trench
 - ▶ Prevents sound transmission
- 7 High-output PowerKon convector:**
 - ▶ The proven combination of copper/aluminium
 - ▶ With EuroKonus valve connection
 - ▶ Suitable for maximum continuous operating pressure of 10 bar and 120°C.
 - ▶ Optimised for air flow and heat dissipation
 - ▶ Painted graphite-grey
- 8 Floor trench:**
 - ▶ Galvanised sheet steel
 - ▶ Painted graphite grey on both sides
 - ▶ With cross bracing to reinforce the floor trench
- A Aluminium roll-up grille, natural anodised:**
 - ▶ Double-T profile grille Roll-up or linear grille
 - ▶ Bar dimensions 18 x 5 mm (Stainless steel 18 x 6 mm)
 - ▶ Bar spacing 9 mm (Stainless steel 10.5 mm)
 - ▶ Connections made of corrosion-proof steel springs with spacers in a matching colour
 - ▶ 65% free area

Matching grilles

Roll-up grilles

Aluminium
Natural anodised

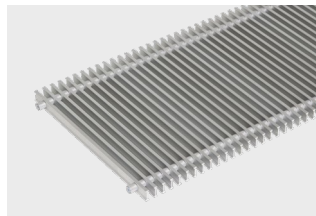

Aluminium
Brass anodised

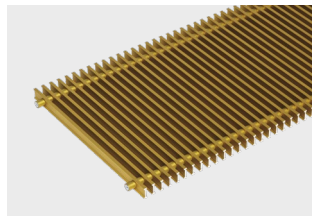

Aluminium
Bronze anodised



Aluminium
Black anodised

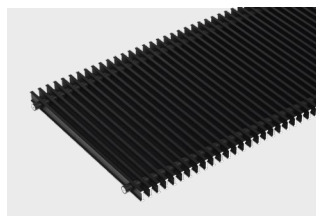

Aluminium
Bronze finish

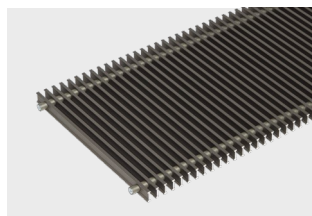

Aluminium
Painted DB 703



Stainless steel
Natural

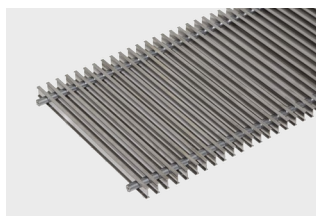

Stainless steel
Polished

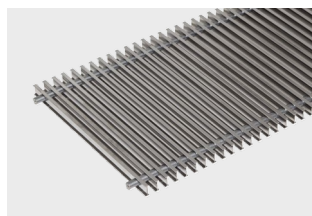

Brass
Natural CuZn 44

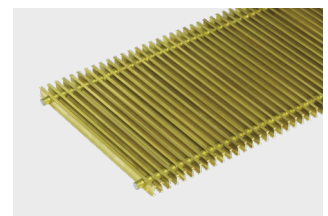

Linear grilles

Aluminium
Natural anodised

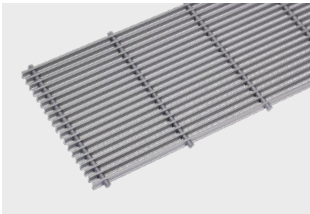

Aluminium
Brass anodised

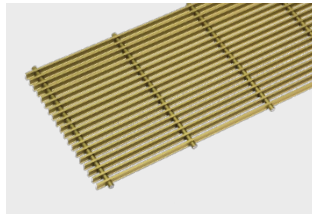

Aluminium
Bronze anodised



Aluminium
Bronze finish

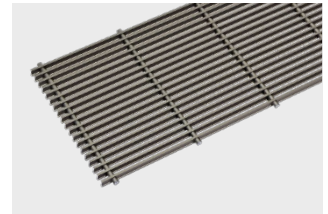

Profile dimensions

Double-T profile

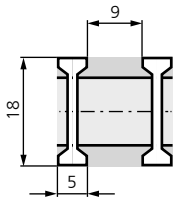

► For more grilles, please refer to Kampmann.co.uk/grilles

The above grilles are shown using a four-colour printing process and thus do not represent an exact reproduction of the original colour.

Katherm NK – supply air modules ZL



- 1 Supply air module with supply air spigot
- 2 Connecting brackets
- 3 Supply air slider
- 4 Reinforcing struts
- 5 Perforated plate
- 6 Filter
- 7 Example of Optiline roll-up grille
- 8 Kammann NK shown with Optiline roll-up grille

Combination of Katherm NK with supply air module

The Katherm supply air module ZL is available for all trench convectors (Katherm range). This represents a 400 mm long trench, which can be fitted to all designs of Katherm units. Treated supply air can also be fed into rooms through the Katherm supply air module ZL. This is configured with different sizes/ designs of spigots for the most diverse trench dimensions. It is possible to regulate the volumetric flow by means of slider elements in the supply air modules.

Benefits:

- ▶ available for trench widths and heights as per the table in the Katherm range
- ▶ supply air feed through the Katherm floor trench
- ▶ low leaving air speeds, hence pleasant levels of comfort
- ▶ also suitable for shallow floors of more than 120 mm
- ▶ low noise when correctly designed
- ▶ low investment and maintenance costs
- ▶ supply air outlets visually identical to Katherm trench heaters
- ▶ no wear parts/no electrically rotating parts

Trench width	Trench length	Trench height	Supply air spigots	Designed air volume
[mm]	[mm]	[mm]	[mm]	[m³/h]
182	400	120	oval 51x128	70
182	400	150	DN 80	60
182	400	200	DN 100	90
232	400	120	oval 51x128	70
232	400	150	DN 80	60
232	400	200	DN 100	90
300	400	120	oval 51x128	70
300	400	150	DN 80	60
300	400	200	DN 100	90
380	400	120	oval 51x128	70
380	400	150	DN 80	60
380	400	200	DN 100	90

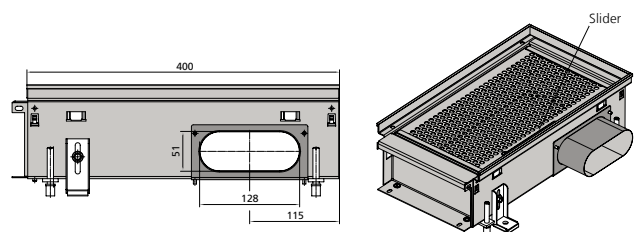

Example of 232/120

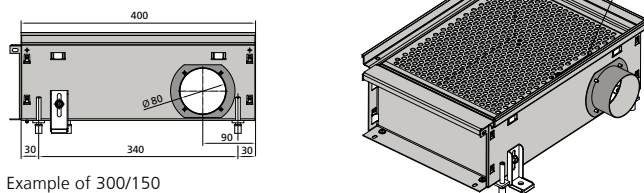

Example of 300/150

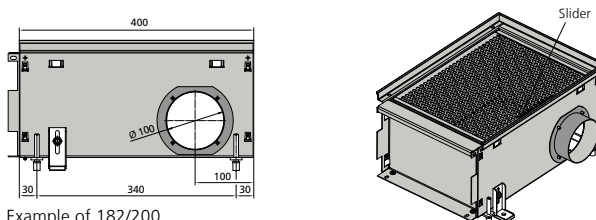

Example of 182/200

Comfort

Comfort also plays a key role in air conditioning. We'll help you to consider this aspect when designing a project using Kampmann trench heating, at the same time as complying with the current guidelines in DIN EN 15251 (in future DIN EN 16798 Parts 1 and 2) and DIN EN ISO 7730. Essentially the following recommended values can be assumed:

For heating:
 Supply air outlet air temperature: 20–26 °C (but not lower than the room temperature)
 Outlet speed: < 1,5 m/s
 Distance of supply air trench to the constantly occupied area: > 0,5 m

For cooling:
 Supply air outlet air temperature: < 4 K below room temperature
 Outlet speed: < 1,2 m/s
 Distance of supply air trench to the constantly occupied area: > 1 m

Other parameters

Consider additional parameters, including room and supply air humidity, as well as leaving air velocity, in individual cases (see DIN EN ISO 7730).

Additional information

The supply air models Katherm ZL can be used for cooling, heating or isothermal air exchange using preconditioned primary air. A connection or spigot connection at the end is also possible with appropriate trench dimensions and sufficient space in the air outlet area (examination on request!).

The upper limit of the air volume in the spigot is calculated from the maximum air speed and cross-section of the spigot. This speed should not exceed 3.0 m/s to avoid additional sound emissions. The resulting air-side pressure losses vary according to the air volume as per the diagram.

Design diagrams

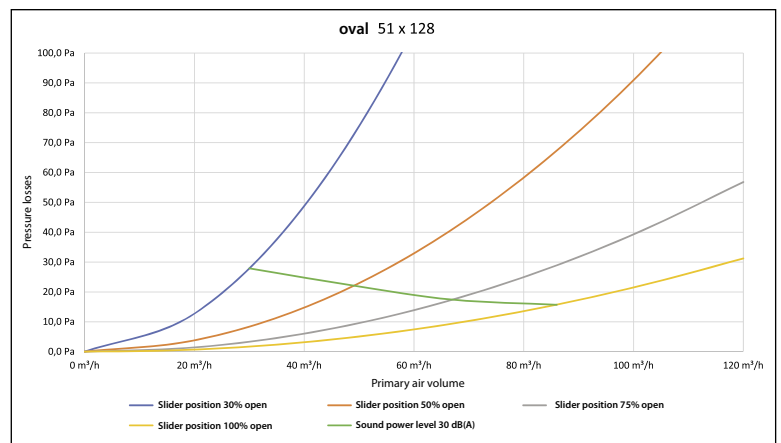
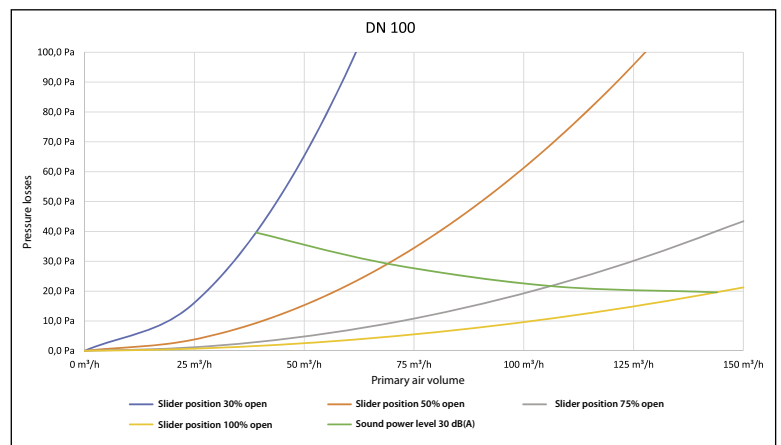
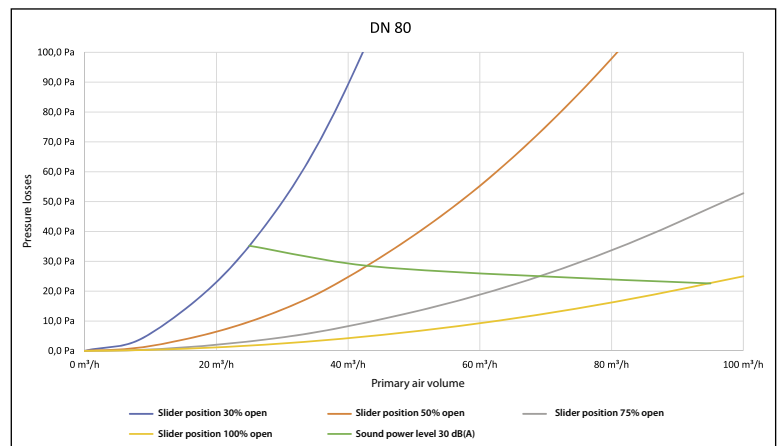

02 ▶ Technical Data

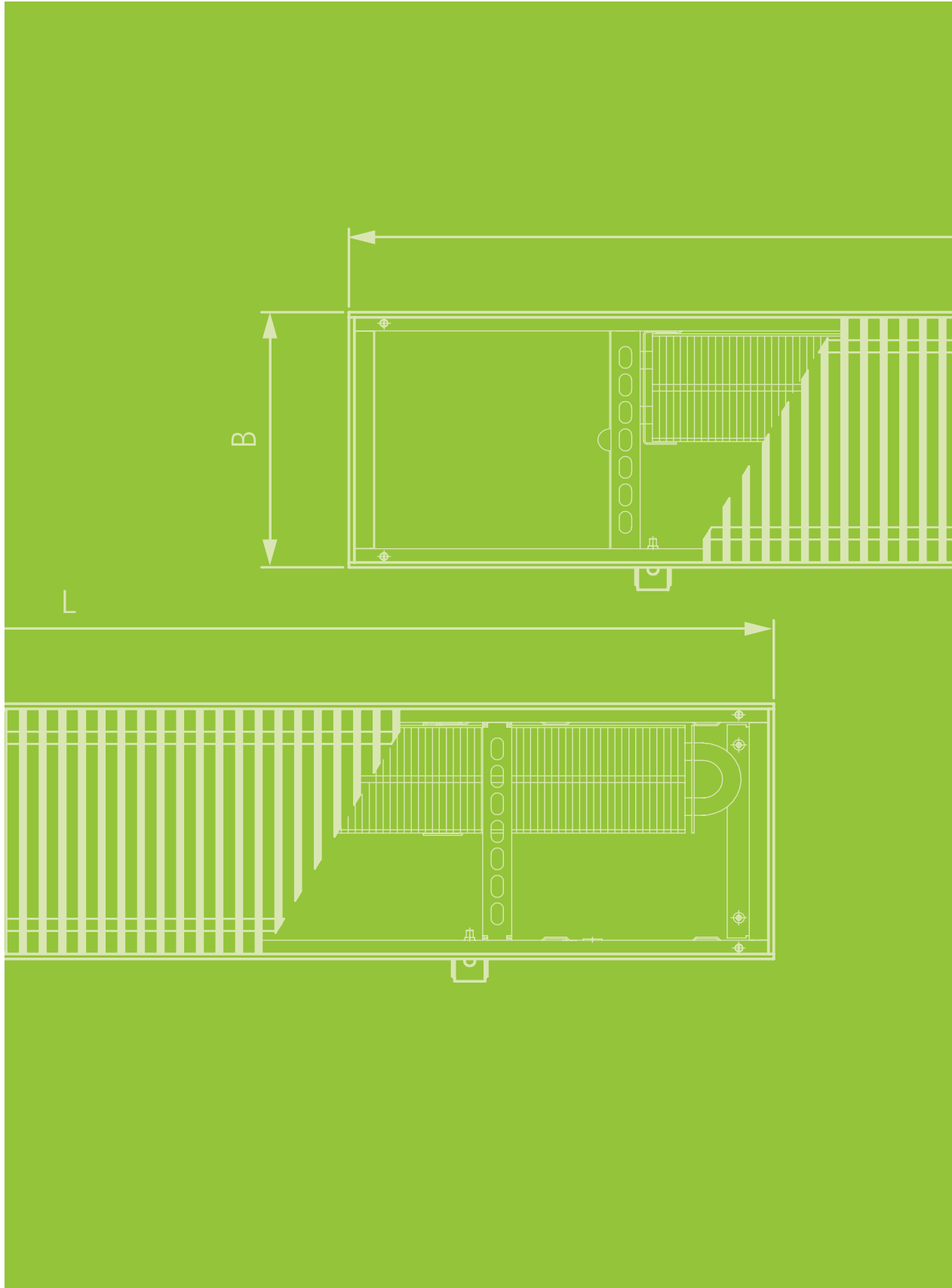

Advice on Measuring Conditions

Heat outputs

The heat outputs were measured in accordance with EN 16430 „Fan-assisted heaters, convectors and trench convectors“.

Part 1 „Technical Specification and Requirements“
Part 2 „Test Method and Evaluation of Heat Output“

The standard regulates the performance measurements specifically of trench convectors based on EN 442 „Radiators and Convectors“.

Part 1 „Technical Specification and Requirements“
Part 2 „Test Procedure and Performance Data“

The specific requirements for trench heating are taken into account in EN 16430. The reference/air temperature is measured in the centre of the test chamber (2 metres from the external wall) at a height of 0.75 metres). Surface temperature of the external wall 16°C. Practical layout at a distance of 50 mm from the external wall.



Room air laboratory

Katherm NK 137

Trench Height 92 mm / 120 mm

Technical Drawings (Dimensions in mm)

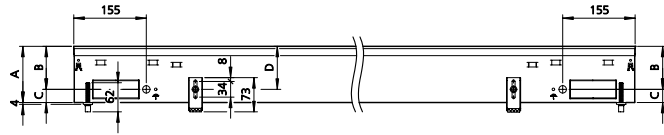

Front view

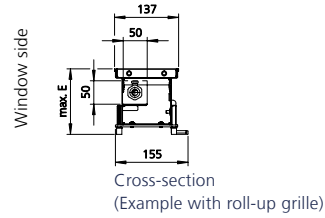

Cross-section
(Example with roll-up grille)

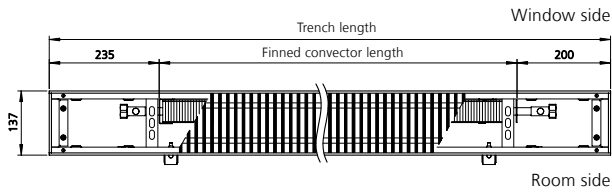

Top view
(view without cover panel)

Trench height	A	B	C	D	Max. E
	[mm]	[mm]	[mm]	[mm]	[mm]
92	64	28	64	126	
120	92	28	92	154	

Specifications

Connections, female thread:

Eurokonus, same end,
left hand side

Make use of our online calculation programs to calculate your heat outputs and flow rates with a couple of clicks!

► Kampmanngroup.com/katherm-nk

Water resistance: Heating curve

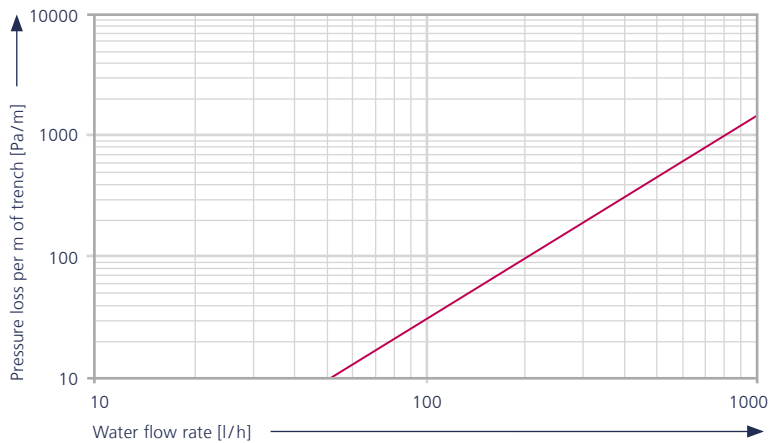

Services



Trench height [mm]	Heat outputs ¹⁾	
	at LPHW 75 / 65 °C Q_N [W]	at LPHW 55 / 45 °C Q [W]
Trench length 800 mm		
92	78	34
120	84	35
Trench length 1000 mm		
92	121	53
120	130	54
Trench length 1200 mm		
92	164	72
120	176	73
Trench length 1400 mm		
92	207	91
120	222	93
Trench length 1600 mm		
92	250	110
120	268	112
Trench length 1800 mm		
92	293	129
120	314	131
Trench length 2000 mm		
92	336	148
120	360	150
Trench length 2200 mm		
92	379	167
120	406	169
Trench length 2400 mm		
92	422	186
120	452	189
Trench length 2600 mm		
92	465	205
120	498	208
Trench length 2800 mm		
92	508	223
120	544	227

[more »](#)



Trench height [mm]	Heat outputs ¹⁾	
	at LPHW 75 / 65 °C Q_N [W]	at LPHW 55 / 45 °C Q [W]
Trench length 3000 mm		
92	551	242
120	590	246
Trench length 3200 mm		
92	594	261
120	636	265
Trench length 3400 mm		
92	637	280
120	682	285
Trench length 3600 mm		
92	680	299
120	728	304
Trench length 3800 mm		
92	723	318
120	774	323
Trench length 4000 mm		
92	766	337
120	820	342
Trench length 4200 mm		
92	809	356
120	866	362
Trench length 4400 mm		
92	852	375
120	912	381
Trench length 4600 mm		
92	895	393
120	958	400
Trench length 4800 mm		
92	938	412
120	1004	419
Trench length 5000 mm		
92	981	431
120	1050	438

Q_N [W] = Standard heat output
 Q [W] = Heat output

¹⁾ at room temperature $t_r = 20^\circ\text{C}$

Katherm NK 182

Trench Height 92 mm / 120 mm / 150 mm / 200 mm

Technical Drawings (Dimensions in mm)

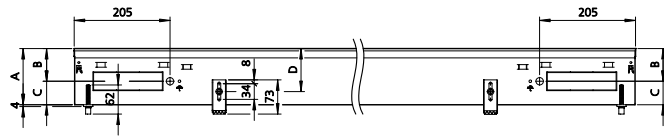

Front view of trench height 92/120 mm

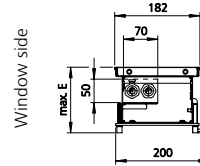

Cross-section through trench height 92/120 mm (example shown with roll-up grille)

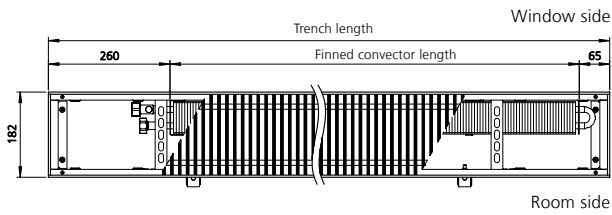

Top view of trench height 92/120 mm (view without cover panel)

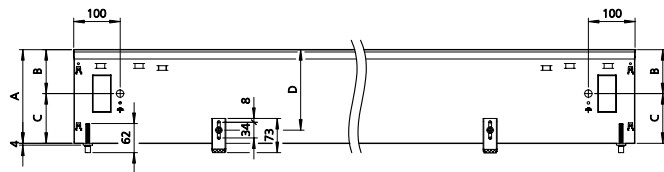

Front view of trench height 150/200 mm

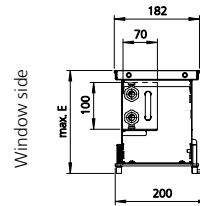

Cross-section through trench height 150/200 mm (example shown with roll-up grille)

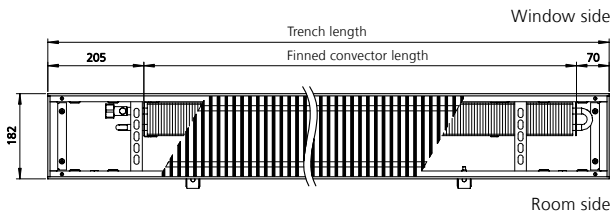

Top view of trench height 150/200 mm (view without cover panel)

Trench height	A	B	C	D	Max. E
	[mm]	[mm]	[mm]	[mm]	[mm]
92	64	28	64	126	
120	70	50	92	154	
150	94	56	122	184	
200	94	106	172	234	

Specifications

Connections, female thread:

Eurokonus, same end, left hand side

Make use of our online calculation programs to calculate your heat outputs and flow rates with a couple of clicks!

► Kampmanngroup.com/katherm-nk

Water resistance: Heating curves

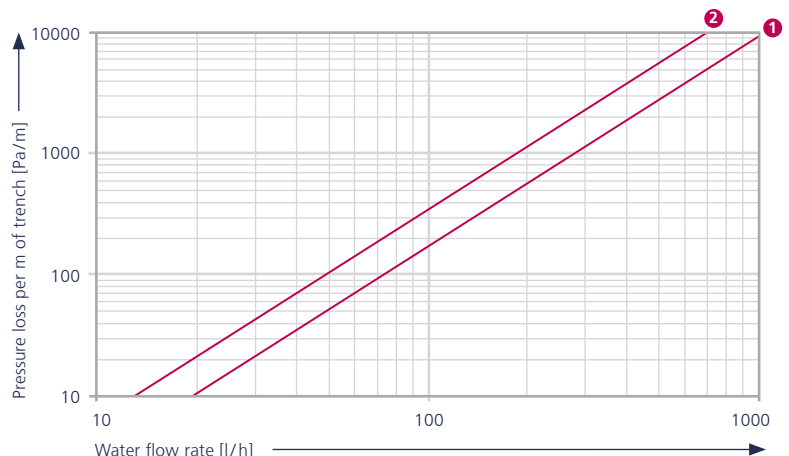

1 Trench height 92 mm/120 mm 2 Trench height 150 mm/200 mm

Services



Trench height [mm]	Heat outputs ¹⁾	
	at LPHW 75 / 65 °C	at LPHW 55 / 45 °C
	Q _N [W]	Q [W]
Trench length 800 mm		
92	132	66
120	162	80
150	206	96
200	232	106
Trench length 1000 mm		
92	187	93
120	230	113
150	285	133
200	320	146
Trench length 1200 mm		
92	242	121
120	298	147
150	364	170
200	408	187
Trench length 1400 mm		
92	298	149
120	367	180
150	442	207
200	496	227
Trench length 1600 mm		
92	353	176
120	435	214
150	521	243
200	584	267
Trench length 1800 mm		
92	409	204
120	503	247
150	599	280
200	673	308
Trench length 2000 mm		
92	464	232
120	571	281
150	678	317
200	761	348
Trench length 2200 mm		
92	519	259
120	639	314
150	757	353
200	849	389

more »



Trench height [mm]	Heat outputs ¹⁾	
	at LPHW 75 / 65 °C	at LPHW 55 / 45 °C
	Q _N [W]	Q [W]
Trench length 2400 mm		
92	575	287
120	708	348
150	835	390
200	937	429
Trench length 2600 mm		
92	630	315
120	776	381
150	914	427
200	1025	469
Trench length 2800 mm		
92	686	342
120	844	415
150	992	464
200	1114	510
Trench length 3000 mm		
92	741	370
120	912	448
150	1071	500
200	1202	550
Trench length 3200 mm		
92	796	398
120	980	482
150	1150	537
200	1290	590
Trench length 3400 mm		
92	852	425
120	1049	516
150	1228	574
200	1378	631
Trench length 3600 mm		
92	907	453
120	1117	549
150	1307	610
200	1466	671
Trench length 3800 mm		
92	963	481
120	1185	583
150	1385	647
200	1555	711

more »



Trench height [mm]	Heat outputs ¹⁾	
	at LPHW 75 / 65 °C	at LPHW 55 / 45 °C
	Q _N [W]	Q [W]
Trench length 4000 mm		
92	1018	508
120	1253	616
150	1464	684
200	1643	752
Trench length 4200 mm		
92	1073	536
120	1321	650
150	1543	721
200	1731	792
Trench length 4400 mm		
92	1129	563
120	1390	683
150	1621	757
200	1819	833
Trench length 4600 mm		
92	1184	591
120	1458	717
150	1700	794
200	1907	873
Trench length 4800 mm		
92	1240	619
120	1526	750
150	1778	831
200	1966	913
Trench length 5000 mm		
92	1295	646
120	1594	784
150	1857	867
200	2084	954

Q_N [W] = Standard heat output
Q [W] = Heat output

¹⁾ at room temperature t_r = 20 °C

Katherm NK 232

Trench Height 92 mm / 120 mm / 150 mm / 200 mm

Technical Drawings (Dimensions in mm)

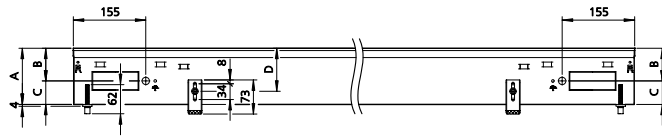

Front view of trench height 92/120 mm

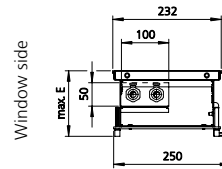

Cross-section through trench height 92/120 mm (example shown with roll-up grille)

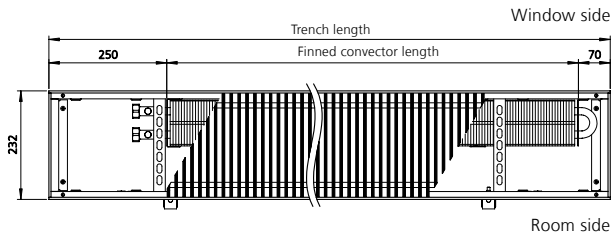

Top view of trench height 92/120 mm (view without cover panel)

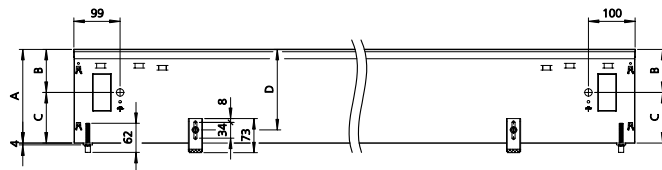

Front view of trench height 150/200 mm

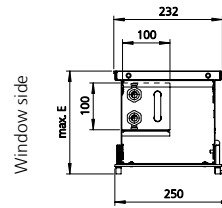

Cross-section through trench height 150/200 mm (example shown with roll-up grille)

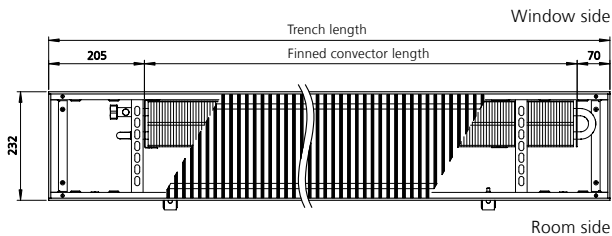

Top view of trench height 150/200 mm (view without cover panel)

Trench height	A	B	C	D	Max. E
	[mm]	[mm]	[mm]	[mm]	[mm]
92	64	28	64	126	
120	70	50	92	154	
150	92	58	122	184	
200	92	108	172	234	

Specifications

Connections, female thread:

Eurokonus, same end, left hand side

Make use of our online calculation programs to calculate your heat outputs and flow rates with a couple of clicks!

► Kampmanngroup.com/katherm-nk

Water resistance: Heating curves

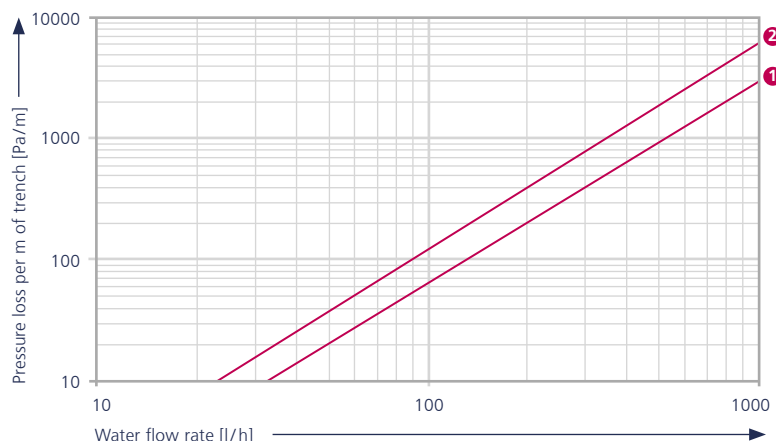

1 Trench height 92 mm/120 mm 2 Trench height 150 mm/200 mm

Services



Trench height [mm]	Heat outputs ¹⁾	
	at LPHW 75 / 65 °C Q _N [W]	at LPHW 55 / 45 °C Q [W]
Trench length 800 mm		
92	157	76
120	193	93
150	309	146
200	334	160
Trench length 1000 mm		
92	222	108
120	273	132
150	426	202
200	462	221
Trench length 1200 mm		
92	288	139
120	354	171
150	544	258
200	589	282
Trench length 1400 mm		
92	353	171
120	434	210
150	662	314
200	717	343
Trench length 1600 mm		
92	419	203
120	515	249
150	779	370
200	844	404
Trench length 1800 mm		
92	484	234
120	595	288
150	897	425
200	971	466
Trench length 2000 mm		
92	549	266
120	675	327
150	1014	481
200	1099	527
Trench length 2200 mm		
92	615	298
120	756	366
150	1132	537
200	1226	588

[more »](#)



Trench height [mm]	Heat outputs ¹⁾	
	at LPHW 75 / 65 °C Q _N [W]	at LPHW 55 / 45 °C Q [W]
Trench length 2400 mm		
92	680	329
120	836	405
150	1250	593
200	1354	649
Trench length 2600 mm		
92	746	361
120	917	444
150	1367	648
200	1481	710
Trench length 2800 mm		
92	811	393
120	997	483
150	1485	704
200	1608	771
Trench length 3000 mm		
92	876	424
120	1077	522
150	1602	760
200	1736	832
Trench length 3200 mm		
92	942	456
120	1158	561
150	1720	816
200	1863	893
Trench length 3400 mm		
92	1007	488
120	1238	599
150	1838	872
200	1991	954
Trench length 3600 mm		
92	1073	519
120	1319	638
150	1955	927
200	2118	1015
Trench length 3800 mm		
92	1138	551
120	1399	677
150	2073	983
200	2245	1076

[more »](#)



Trench height [mm]	Heat outputs ¹⁾	
	at LPHW 75 / 65 °C Q _N [W]	at LPHW 55 / 45 °C Q [W]
Trench length 4000 mm		
92	1203	583
120	1479	716
150	2190	1039
200	2373	1137
Trench length 4200 mm		
92	1269	614
120	1560	755
150	2308	1095
200	2500	1198
Trench length 4400 mm		
92	1334	646
120	1640	794
150	2426	1151
200	2628	1259
Trench length 4600 mm		
92	1400	678
120	1721	833
150	2543	1206
200	2755	1320
Trench length 4800 mm		
92	1465	709
120	1801	872
150	2661	1262
200	2882	1381
Trench length 5000 mm		
92	1530	741
120	1881	911
150	2778	1318
200	3010	1442

Q_N [W] = Standard heat output
Q [W] = Heat output

¹⁾ at room temperature t_r = 20 °C

Katherm NK 300

Trench Height 92 mm / 120 mm / 150 mm / 200 mm

Technical Drawings (Dimensions in mm)

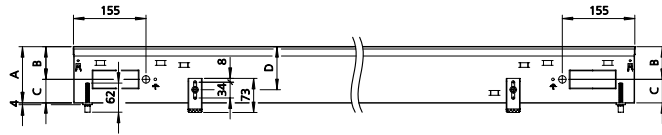

Front view of trench height 92/120 mm

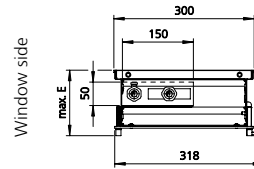

Cross-section through trench height 92/120 mm (example shown with roll-up grille)

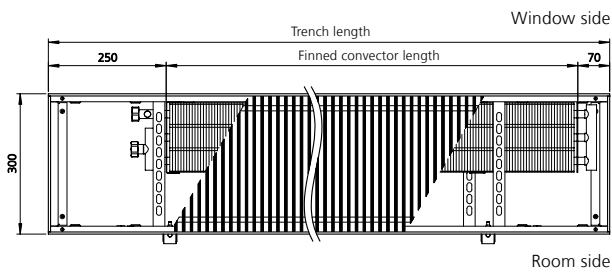

Top view of trench height 92/120 mm (view without cover panel)

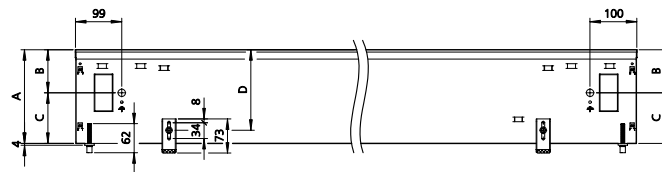

Front view of trench height 150/200 mm

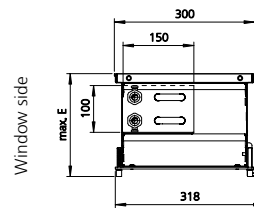

Cross-section through trench height 150/200 mm (example shown with roll-up grille)

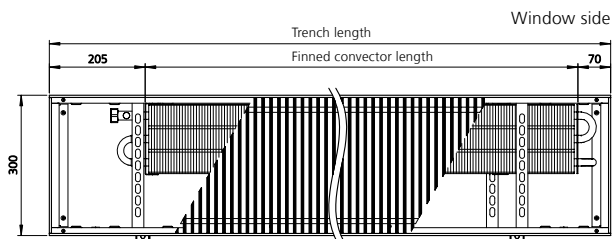

Top view of trench height 150/200 mm (view without cover panel)

Trench height	A	B	C	D	Max. E
[mm]	[mm]	[mm]	[mm]	[mm]	[mm]
92	62	28	64	126	
120	70	50	92	154	
150	92	58	122	184	
200	92	108	172	234	

Specifications

Connections, female thread:

Eurokonus, same end, left hand side

Make use of our online calculation programs to calculate your heat outputs and flow rates with a couple of clicks!

► Kampmanngroup.com/katherm-nk

Water resistance: Heating curves

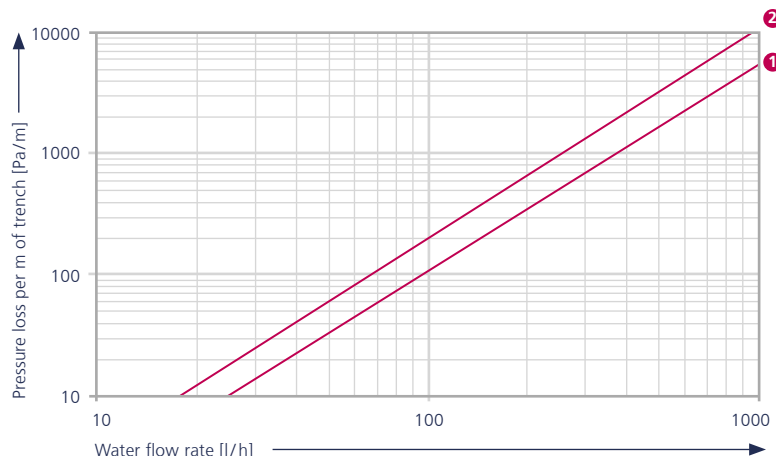

1 Trench height 92 mm/120 mm 2 Trench height 150 mm/200 mm

Services



Trench height [mm]	Heat outputs ¹⁾	
	at LPHW 75 / 65 °C Q _N [W]	at LPHW 55 / 45 °C Q [W]
Trench length 800 mm		
92	209	104
120	268	133
150	394	189
200	445	211
Trench length 1000 mm		
92	296	147
120	379	188
150	544	261
200	614	291
Trench length 1200 mm		
92	383	190
120	491	244
150	694	333
200	784	372
Trench length 1400 mm		
92	470	233
120	602	299
150	844	404
200	953	452
Trench length 1600 mm		
92	557	277
120	714	354
150	994	476
200	1122	532
Trench length 1800 mm		
92	644	320
120	825	410
150	1144	548
200	1292	613
Trench length 2000 mm		
92	731	363
120	937	465
150	1294	620
200	1461	693
Trench length 2200 mm		
92	818	406
120	1048	521
150	1444	692
200	1631	774

[more »](#)



Trench height [mm]	Heat outputs ¹⁾	
	at LPHW 75 / 65 °C Q _N [W]	at LPHW 55 / 45 °C Q [W]
Trench length 2400 mm		
92	905	449
120	1160	576
150	1594	764
200	1800	854
Trench length 2600 mm		
92	992	493
120	1271	631
150	1744	836
200	1970	934
Trench length 2800 mm		
92	1079	536
120	1383	687
150	1894	908
200	2139	1015
Trench length 3000 mm		
92	1166	579
120	1494	742
150	2044	980
200	2308	1095
Trench length 3200 mm		
92	1253	622
120	1606	798
150	2194	1052
200	2478	1175
Trench length 3400 mm		
92	1340	665
120	1717	853
150	2344	1123
200	2647	1256
Trench length 3600 mm		
92	1427	709
120	1829	908
150	2494	1195
200	2817	1336
Trench length 3800 mm		
92	1514	752
120	1940	964
150	2644	1267
200	2986	1416

[more »](#)



Trench height [mm]	Heat outputs ¹⁾	
	at LPHW 75 / 65 °C Q _N [W]	at LPHW 55 / 45 °C Q [W]
Trench length 4000 mm		
92	1601	795
120	2052	1019
150	2794	1339
200	3156	1497
Trench length 4200 mm		
92	1688	838
120	2163	1074
150	2944	1411
200	3325	1577
Trench length 4400 mm		
92	1775	882
120	2275	1130
150	3094	1483
200	3494	1658
Trench length 4600 mm		
92	1862	925
120	2386	1185
150	3244	1555
200	3664	1738
Trench length 4800 mm		
92	1949	968
120	2498	1241
150	3395	1627
200	3833	1818
Trench length 5000 mm		
92	2036	1011
120	2609	1296
150	3545	1699
200	4003	1899

Q_N [W] = Standard heat output
Q [W] = Heat output

¹⁾ at room temperature t_r = 20°C

Katherm NK 380

Trench Height 92 mm / 120 mm / 150 mm / 200 mm

Technical Drawings (Dimensions in mm)

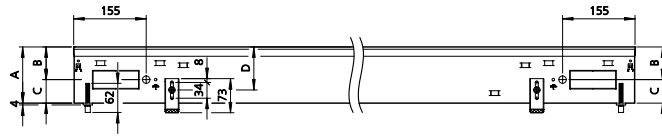

Front view of trench height 92/120 mm

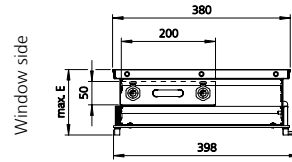

Cross-section through trench height 92/120 mm (example shown with roll-up grille)

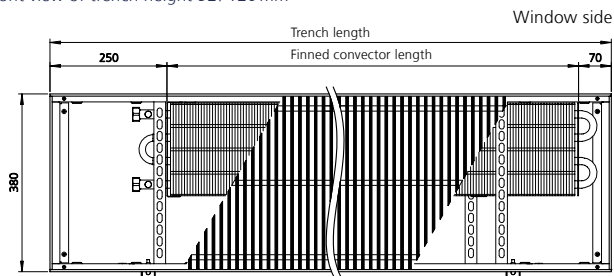

Top view of trench height 92/120 mm (view without cover panel)

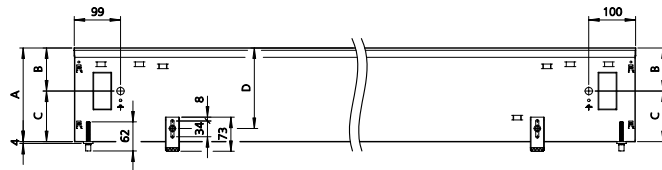

Front view of trench height 150/200 mm

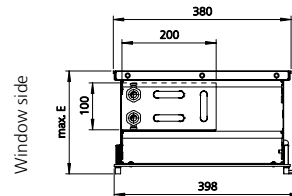

Cross-section through trench height 150/200 mm (example shown with roll-up grille)

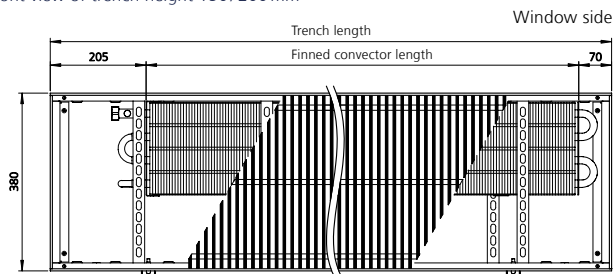

Top view of trench height 150/200 mm (view without cover panel)

Trench height	A	B	C	D	Max. E
[mm]	[mm]	[mm]	[mm]	[mm]	[mm]
92	64	28	64	126	126
120	70	50	92	154	154
150	92	58	122	184	184
200	92	108	172	234	234

Specifications

Connections, female thread:

Eurokonus, same end,
left hand side

Make use of our online calculation programs to calculate your heat outputs and flow rates with a couple of clicks!

► Kampmanngroup.com/katherm-nk

Water resistance: Heating curves

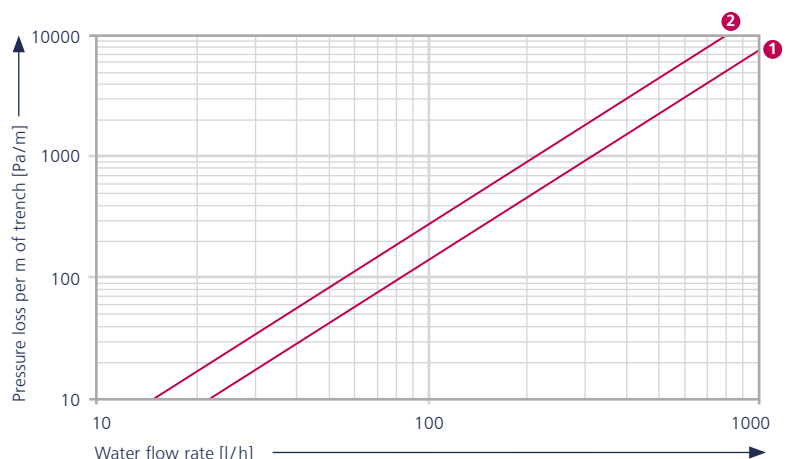

1 Trench height 92 mm/120 mm 2 Trench height 150 mm/200 mm

Services



Trench height [mm]	Heat outputs ¹⁾	
	at LPHW 75 / 65 °C Q _N [W]	at LPHW 55 / 45 °C Q [W]
Trench length 800 mm		
92	279	142
120	344	173
150	485	235
200	621	299
Trench length 1000 mm		
92	395	201
120	487	246
150	669	324
200	858	413
Trench length 1200 mm		
92	511	260
120	631	318
150	854	413
200	1094	527
Trench length 1400 mm		
92	627	319
120	774	390
150	1039	503
200	1331	641
Trench length 1600 mm		
92	743	379
120	917	463
150	1223	592
200	1568	755
Trench length 1800 mm		
92	859	438
120	1060	535
150	1408	682
200	1804	869
Trench length 2000 mm		
92	975	497
120	1204	607
150	1593	771
200	2041	983
Trench length 2200 mm		
92	1091	556
120	1347	679
150	1777	860
200	2278	1097

[more »](#)



Trench height [mm]	Heat outputs ¹⁾	
	at LPHW 75 / 65 °C Q _N [W]	at LPHW 55 / 45 °C Q [W]
Trench length 2400 mm		
92	1207	615
120	1490	752
150	1962	950
200	2514	1211
Trench length 2600 mm		
92	1323	674
120	1634	824
150	2147	1039
200	2751	1325
Trench length 2800 mm		
92	1440	733
120	1777	896
150	2331	1129
200	2987	1439
Trench length 3000 mm		
92	1556	793
120	1920	968
150	2516	1218
200	3224	1553
Trench length 3200 mm		
92	1672	852
120	2064	1041
150	2700	1307
200	3461	1667
Trench length 3400 mm		
92	1788	911
120	2207	1113
150	2885	1397
200	3697	1781
Trench length 3600 mm		
92	1904	970
120	2350	1185
150	3070	1486
200	3934	1895
Trench length 3800 mm		
92	2020	1029
120	2493	1258
150	3254	1576
200	4171	2009

[more »](#)



Trench height [mm]	Heat outputs ¹⁾	
	at LPHW 75 / 65 °C Q _N [W]	at LPHW 55 / 45 °C Q [W]
Trench length 4000 mm		
92	2136	1088
120	2637	1330
150	3439	1665
200	4407	2123
Trench length 4200 mm		
92	2252	1148
120	2780	1402
150	3624	1754
200	4644	2237
Trench length 4400 mm		
92	2368	1207
120	2923	1474
150	3808	1844
200	4881	2351
Trench length 4600 mm		
92	2484	1266
120	3067	1547
150	3993	1933
200	5117	2465
Trench length 4800 mm		
92	2601	1325
120	3210	1619
150	4178	2023
200	5354	2579
Trench length 5000 mm		
92	2717	1384
120	3353	1691
150	4362	2112
200	5590	2693

Q_N [W] = Standard heat output
Q [W] = Heat output

¹⁾ at room temperature t_r = 20 °C

03 ▶ Design information



Information on Planning and Design

Katherm NK are suitable for use in all kinds of buildings demanding heating. Katherm NK are also used to efficiently combat condensation on external glazing.

They are generally position directly in front of the external façade without a large gap. Katherm NK provide effective heating, particularly in front of large areas of glazing.

Air outlet

All Katherm NK are positioned with the convector on the window side. The warm air rising up the exterior façade flows draught-free into the room, guaranteeing optimum cold air screening.

Heat outputs

The heat outputs were tested in accordance with EN 16430. We would recommend our online calculation programs to convert to other operating conditions.

Kampmanngroup.com/katherm-nk

Make use of our online calculation programs to calculate your heat outputs and flow rates with a couple of clicks!

► Kampmanngroup.com/katherm-nk

04 ▶ Control

Convenient surface- or flush-mounted electrical control

Room thermostat, surface-mounted



In an attractively styled flat surface-mounted housing, with thermal feedback. A 55 mm diameter back box is needed for installation.

Product Features

- ▶ Housing: Surface-mounted, white
- ▶ Voltage: 230 V/50 Hz
- ▶ Temperature setting range: 5–30°C
- ▶ Switching differential: 0.6 K
- ▶ Protection class: IP30
- ▶ Dimensions W x H x D: 70 x 70 x 35 mm

Room thermostat, flush-mounted



Flush-mounted, with temperature setpoint indicator, main on/off switch with indicator light, thermal feedback and additional signal input for night setback (4 K) via an external timer.

Product features

- ▶ Housing: Jung system, flush-mounted, alpine white
- ▶ Voltage: 230 V/50 Hz
- ▶ Temperature setting range: 5–30°C
- ▶ Protection class: IP20
- ▶ Dimensions W x H x D: 65 x 65 x 42 mm

Clock thermostat, surface-mounted

Combination of room and clock thermostat:
The precise digital clock with weekly program or day program can be used. The required room temperature and the setback temperature can be set easily and clearly. The „Party switch“ enables a setback interval to be over-ridden. Day or night temperatures can be switched on permanently.

Product features

- ▶ Voltage: 230 V/50 Hz
- ▶ Temperature setting range: 10–30°C
- ▶ Protection class: IP20
- ▶ Dimensions W x H x D: 140 x 70 x 30 mm

Clock thermostat, flush-mounted

Combination of room and clock thermostat, flush-mounted, large-screen display of set and actual values, control panel with four buttons for setting day or weekly programs, party function, frost protection, pre-set and adjustable time programs with summer/winter changeover, maximum 9 switching times per day, block switching times are possible.

Product features

- ▶ Housing: white
- ▶ Voltage: 230 V/50 Hz
- ▶ Temperature setting range: 5–30°C
- ▶ Protection class: IP20
- ▶ Power reserve: approx. 10 years
- ▶ N/O contact: potential-free
- ▶ Max. current load: 4 A
- ▶ Dimensions W x H x D: 80.5 x 80.5 x 17.5 mm (installed height)

Suggested control option

One possible electrical control option is the combination of room thermostat and the appropriate number of actuators and valves.

The required room temperature is set on the room thermostat. If the room temperature falls below this setpoint, the thermoelectric valve opens the waterside valve.

Overview of valve bodies, pre-adjustable/return shut-off valves

Trench height	Flow Eurokonus connection	Return Eurokonus connection
[mm]		
NK 137		
92	Valve, axial, type 194000346911	Return shut-off valve, straight type 194000145952
120		
NK 182		
92	Valve, axial, type 194000346911	Return shut-off valve, straight type 194000145952
120		
150	Valve, straight, type 194000346909	
200		
NK 232, NK 330, NK 380		
92	Valve, straight, type 194000346909	Return shut-off valve, straight type 194000145952
120		
150		
200		

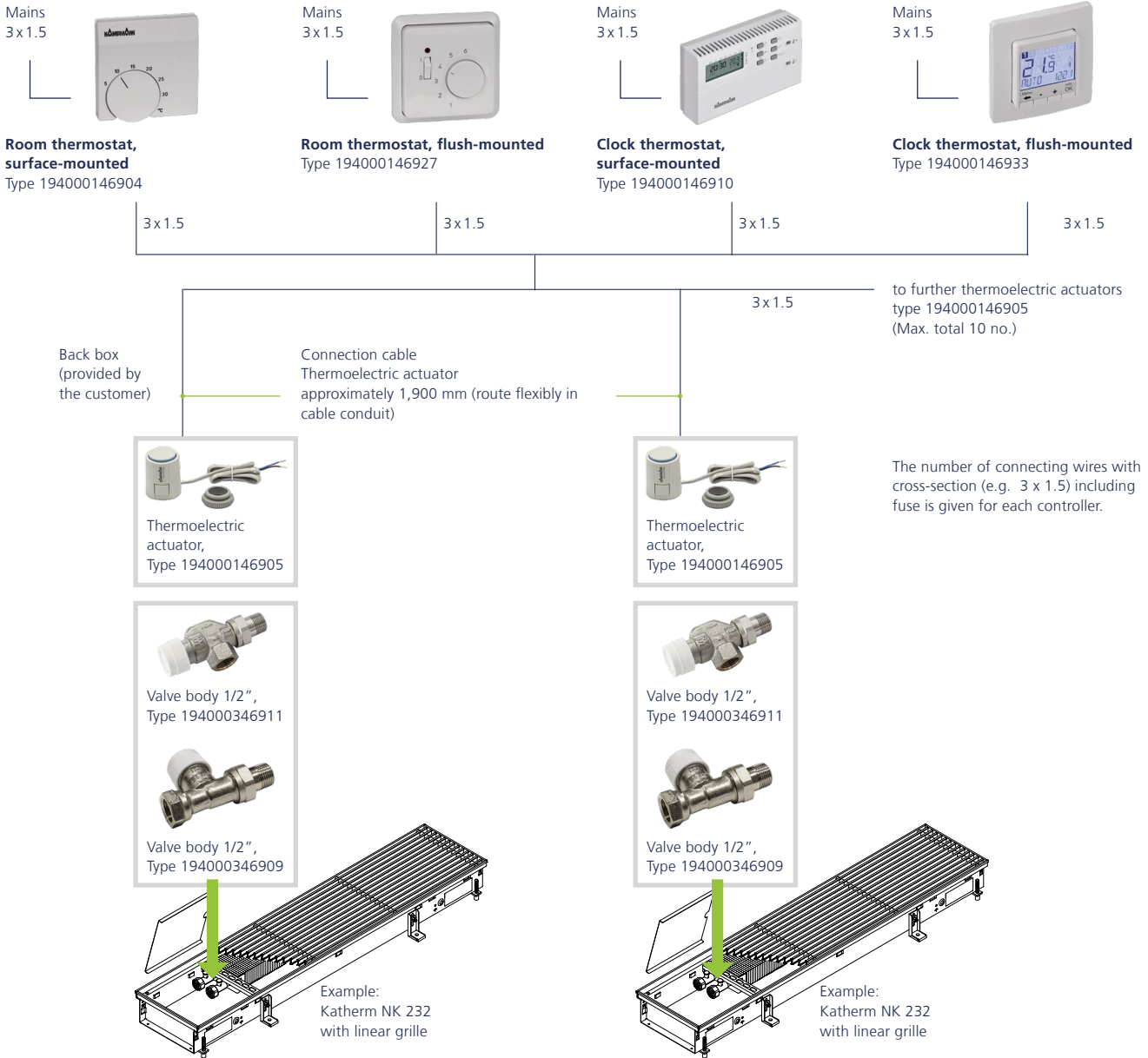

05 ▶ Ordering Information

Kathern NK

Model	Trench width	Trench height	Grille finish	Art. no.
				[mm]
Trench: 800 mm – 5000 mm				
NK 137	182	92	Roll-up grille	1451409111
			Linear grille	1451409311
		120	Roll-up grille	1451412111
			Linear grille	1451412311
NK 182	182	92	Roll-up grille	1451909111
			Linear grille	1451909311
		120	Roll-up grille	1451912111
			Linear grille	1451912311
		150	Roll-up grille	1451915111
			Linear grille	1451915311
		200	Roll-up grille	1451920111
			Linear grille	1451920311
NK 232	232	92	Roll-up grille	1452409111
			Linear grille	1452409311
		120	Roll-up grille	1452412111
			Linear grille	1452412311
		150	Roll-up grille	1452415111
			Linear grille	1452415311
		200	Roll-up grille	1452420111
			Linear grille	1452420311
NK 300	300	92	Roll-up grille	1453009111
			Linear grille	1453009311
		120	Roll-up grille	1453012111
			Linear grille	1453012311
		150	Roll-up grille	1453015111
			Linear grille	1453015311
200	Roll-up grille	1453020111		
	Linear grille	1453020311		
NK 380	380	92	Roll-up grille	1453809111
			Linear grille	1453809311
		120	Roll-up grille	1453812111
			Linear grille	1453812311
		150	Roll-up grille	1453815111
			Linear grille	1453815311
		200	Roll-up grille	1453820111
			Linear grille	1453820311

0 → 0 →

Trench heaters are supplied as standard with a natural anodised aluminium grille. This can be replaced by one of the following grilles at a surcharge. Please change the two red digits to the left of the red line in the article number to select an alternative grille.

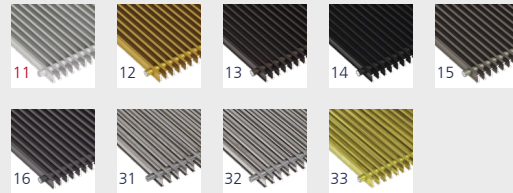

Article key for grille finish (Example of Art. no.)

- 145140911111
- 11 → Aluminium, natural anodised (standard)
 - 12 → Aluminium, brass anodised
 - 13 → Aluminium, bronze anodised
 - 14 → Aluminium, black anodised
 - 15 → Aluminium, bronze finish
 - 16 → Aluminium, painted DB 703
 - 31 → Stainless steel, natural
 - 32 → Stainless steel, polished
 - 33 → Brass, natural CuZn 44

The available convector lengths are in 200 mm increments (800 mm to 5000 mm). Please change the two red digits to the right of the red line in the article number to select the required convector length.

Article key for grille finish (Example of Art. no.)

- 145140911111
- 15 → Trench length 1000 mm
 - 19 → Trench length 1200 mm
 - 23 → Trench length 1400 mm
 - 27 → Trench length 1600 mm
 - 31 → Trench length 1800 mm
 - 35 → Trench length 2000 mm
 - 39 → Trench length 2200 mm
 - 43 → Trench length 2400 mm
 - 47 → Trench length 2600 mm
 - 51 → Trench length 2800 mm
 - 55 → Trench length 3000 mm
 - 59 → Trench length 3200 mm
 - 63 → Trench length 3400 mm
 - 67 → Trench length 3600 mm
 - 71 → Trench length 3800 mm
 - 75 → Trench length 4000 mm
 - 79 → Trench length 4200 mm
 - 83 → Trench length 4400 mm
 - 87 → Trench length 4600 mm
 - 91 → Trench length 4800 mm
 - 95 → Trench length 5000 mm

Accessories

Figure	Article	Properties	Suitable for	Art. no.
Thermostats				
	Room thermostat	230 V, flush-mounted, white front / frame	all Katherm NK	194000146927
		230 V, surface-mounted, white	all Katherm NK	194000146904
	Electronic clock thermostat	surface-mounted, 230 V, white, with day / night / week programme	all Katherm NK	194000146910
	Clock thermostat	flush-mounted, 230 V, white	all Katherm NK	194000146933
Valves				
	Vale body, axial, connection 1/2" pre-settable	as a low-noise, flow-optimised design with stainless steel spindle and double O-ring seal, to fit Katherm NK with actuator art. no. 194000146905, max. operating temperature 120°C, max. operating pressure 10 bar	NK 137, NK 182 (trench height 92 mm, 120 mm)	194000346911
	Valve body, straight, connection 1/2", pre-settable		NK 182 (trench height 150 mm, 200 mm), NK 232, NK 330, NK 380	194000346909
Return valves				
	Return shut-off valve, straight, connection 1/2"	brass, nickel-plated housing, with O-ring seal, max operating temperature 120°C, maximum operating pressure 10 bar	all Katherm NK	194000145952
	Adjustment key	pre-settable	Valve bodies Art. no. 194000346911, Art. no. 194000346909	194000346915
Valve actuators				
	Thermoelectric actuator, 230 V	Power uptake approx. 5 W, Connecting cable length approx. 1,900 mm Overall height 69 mm, diameter 42 mm, Connection thread 30 x 1.5 mm	Valve bodies Art. no. 194000346911, Art. no. 194000346909	194000146905
Other accessories				
	Installation cover	made of timber; on request all Katherm NK units can be supplied with the grilles separately packed to prevent soiling or damage on site prior to fitting.	NK 137	194000100913
			NK 182	194000100918
			NK 232	194000100923
			NK 300	194000100930
			NK 38	194000100938

Kampmanngroup.com/katherm-nk

Kampmann GmbH
Friedrich-Ebert-Str. 128 - 130
49811 Lingen (Ems)
Germany

T +49 591 7108-660
F +49 591 7108-173
E export@kampmann.de
W Kampmann.eu